



US00D815923S

(12) **United States Design Patent**
Watson

(10) **Patent No.:** **US D815,923 S**

(45) **Date of Patent:** **** *Apr. 24, 2018**

(54) **BOTTLE HANDLE**

(71) Applicant: **Christopher James Watson**, Bonney Lake, WA (US)

(72) Inventor: **Christopher James Watson**, Bonney Lake, WA (US)

(*) Notice: This patent is subject to a terminal disclaimer.

(**) Term: **15 Years**

(21) Appl. No.: **29/569,292**

(22) Filed: **Jun. 24, 2016**

(51) **LOC (11) Cl.** **07-06**

(52) **U.S. Cl.**
USPC **D7/622**

(58) **Field of Classification Search**
USPC D7/619.1-625, 509-511, 533-536, 393, D7/396.2; D9/455, 434, 443
CPC . B44D 3/14; B67B 7/18; A47J 45/077; B29C 49/54; B65D 23/106; A47G 23/0216; A47G 23/0266; E06C 7/14
See application file for complete search history.

(56) **References Cited**

U.S. PATENT DOCUMENTS

- 4,273,246 A * 6/1981 Thompson B29C 49/54
215/398
- 4,456,135 A * 6/1984 Beekes B65D 23/106
215/396
- 4,768,403 A * 9/1988 Bar-Noy B67B 7/18
215/390

- 4,821,372 A * 4/1989 Casiello A47J 45/077
16/425
- 4,936,614 A * 6/1990 Russell B65D 23/106
215/396
- 5,025,940 A * 6/1991 Akly B65D 23/106
215/395
- 5,413,231 A * 5/1995 Carroll B65D 23/106
215/396
- D396,385 S * 7/1998 Lisciotti, Jr. D7/622
- D462,879 S * 9/2002 Martens D7/622

* cited by examiner

Primary Examiner — Terry A Wallace

(74) *Attorney, Agent, or Firm* — Ruttler Mills, PLLC;
James J. Ruttler

(57) **CLAIM**

The ornamental design for a bottle handle, as shown and described.

DESCRIPTION

FIG. 1 is a front perspective view of the bottle handle showing my new design.
 FIG. 2 is a rear perspective view thereof.
 FIG. 3 is a top plan view thereof.
 FIG. 4 is a bottom plan view thereof.
 FIG. 5 is a left side view thereof.
 FIG. 6 is a right side view thereof.
 FIG. 7 is a front view thereof.
 FIG. 8 is a rear view thereof; and,
 FIG. 9 is a perspective view thereof with a bottle shown in broken lines for illustrative purposes only and forming no part of the claimed design.
 The portions of the bottle shown in broken lines form no part of the claimed design.

1 Claim, 6 Drawing Sheets

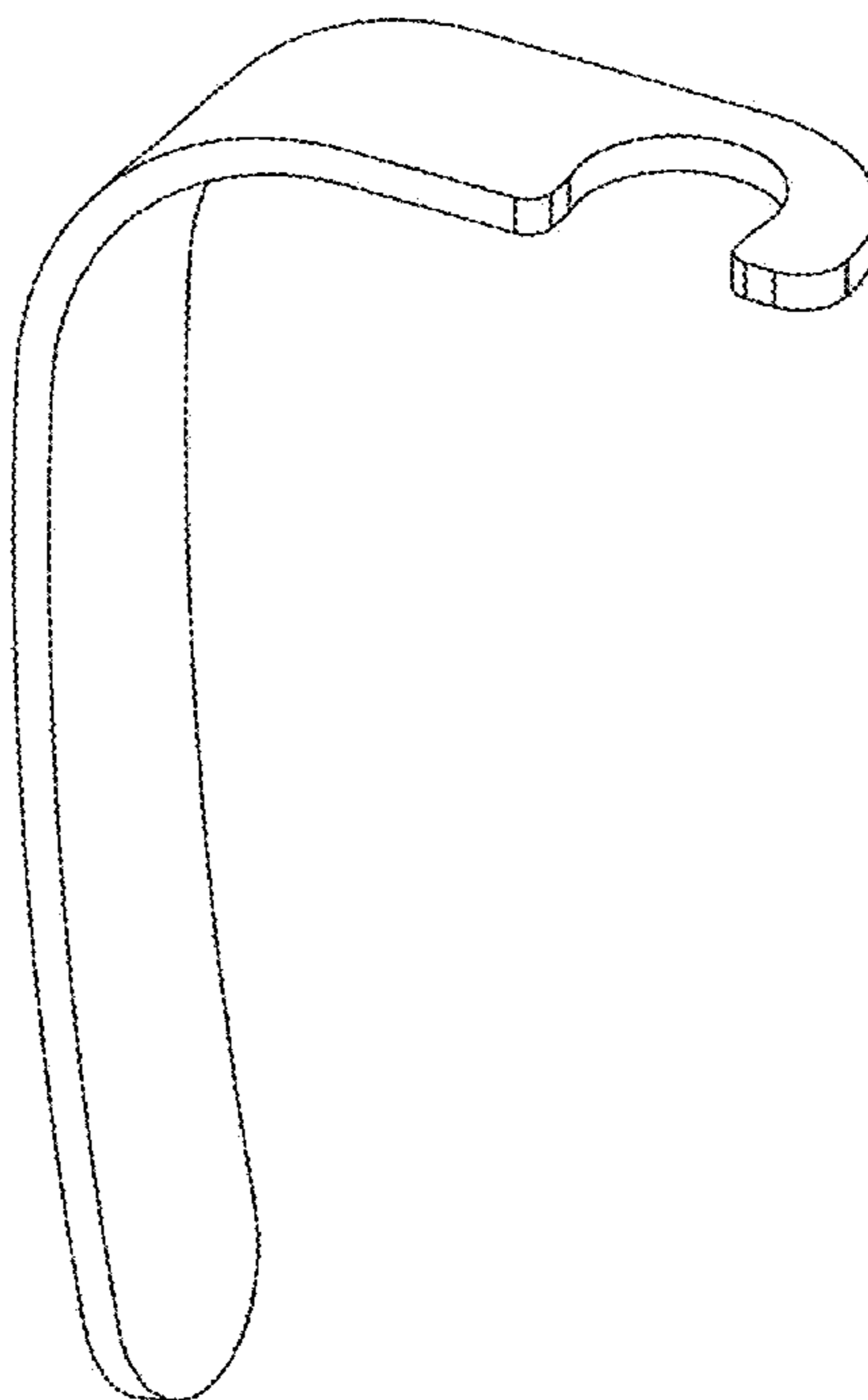

Figure 1

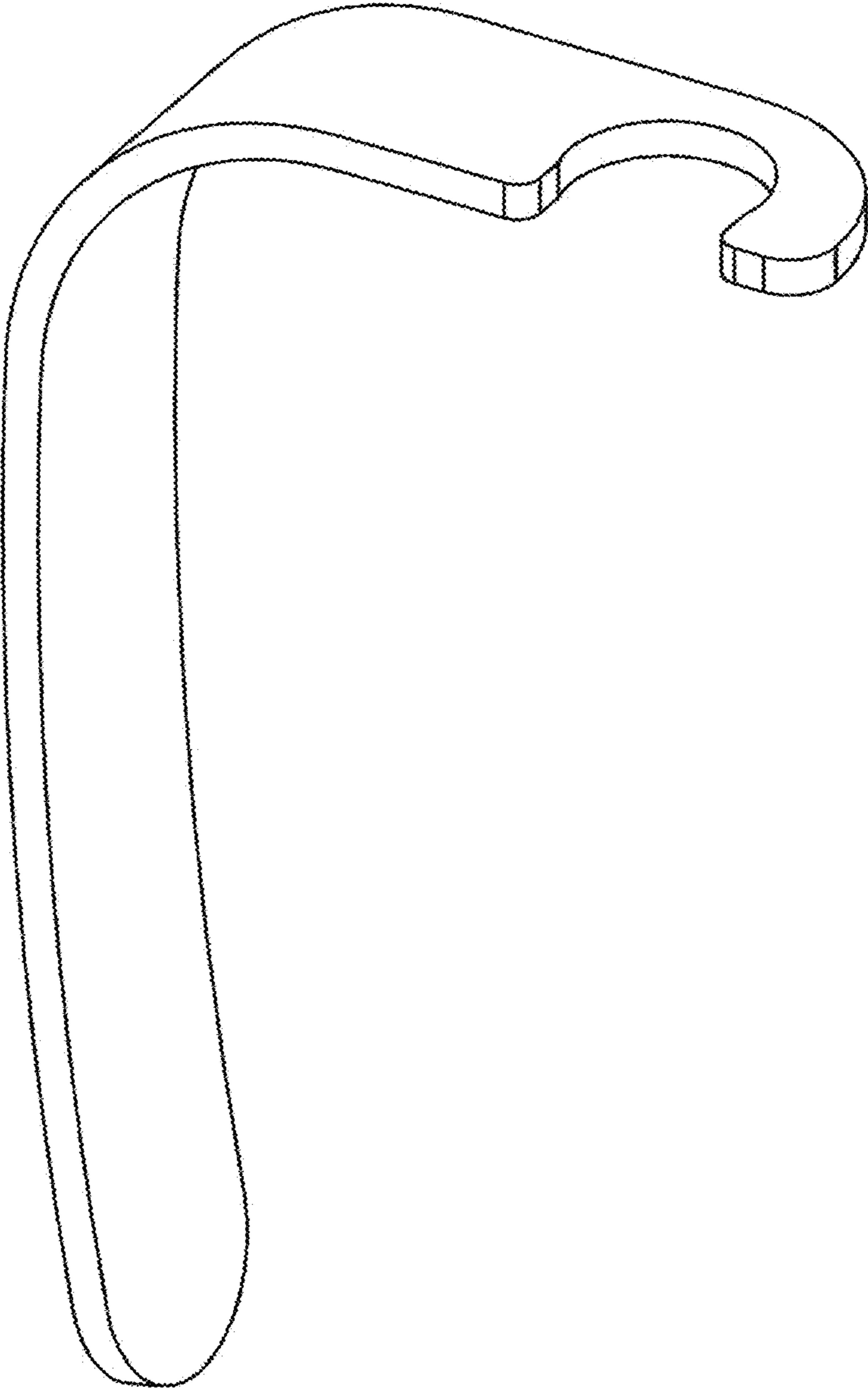

Figure 2



Figure 3

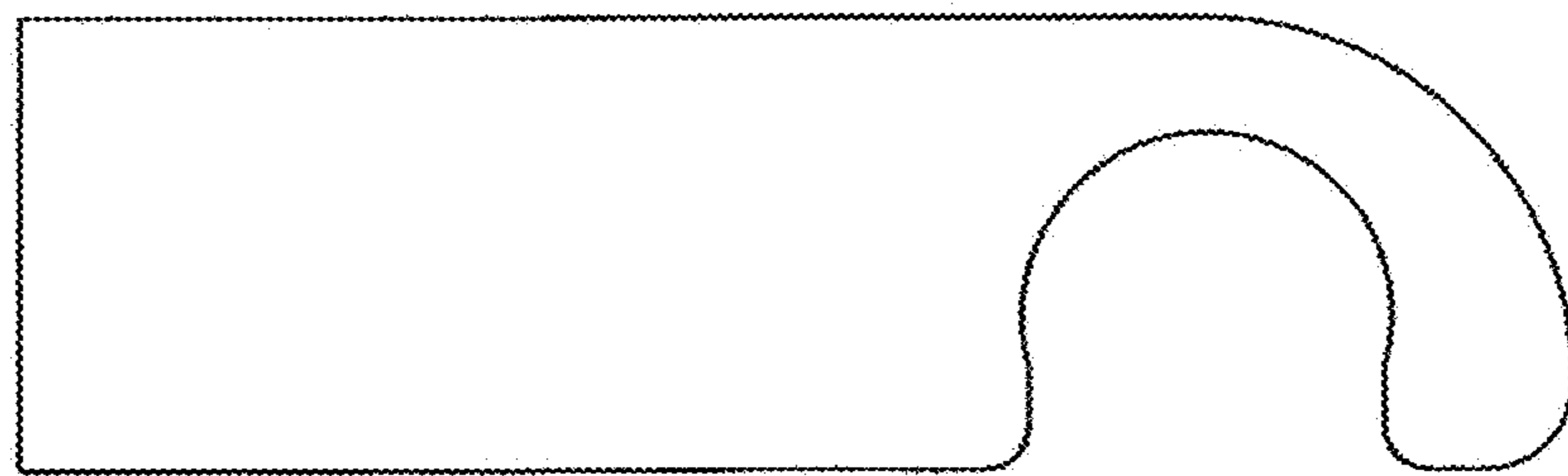

Figure 4

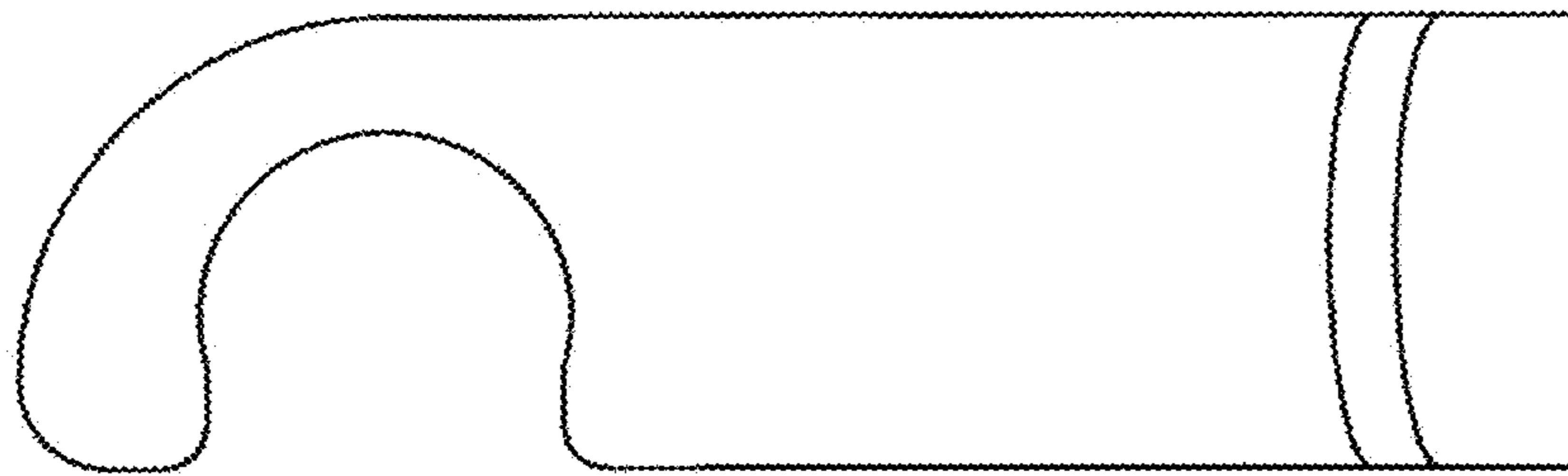

Figure 5

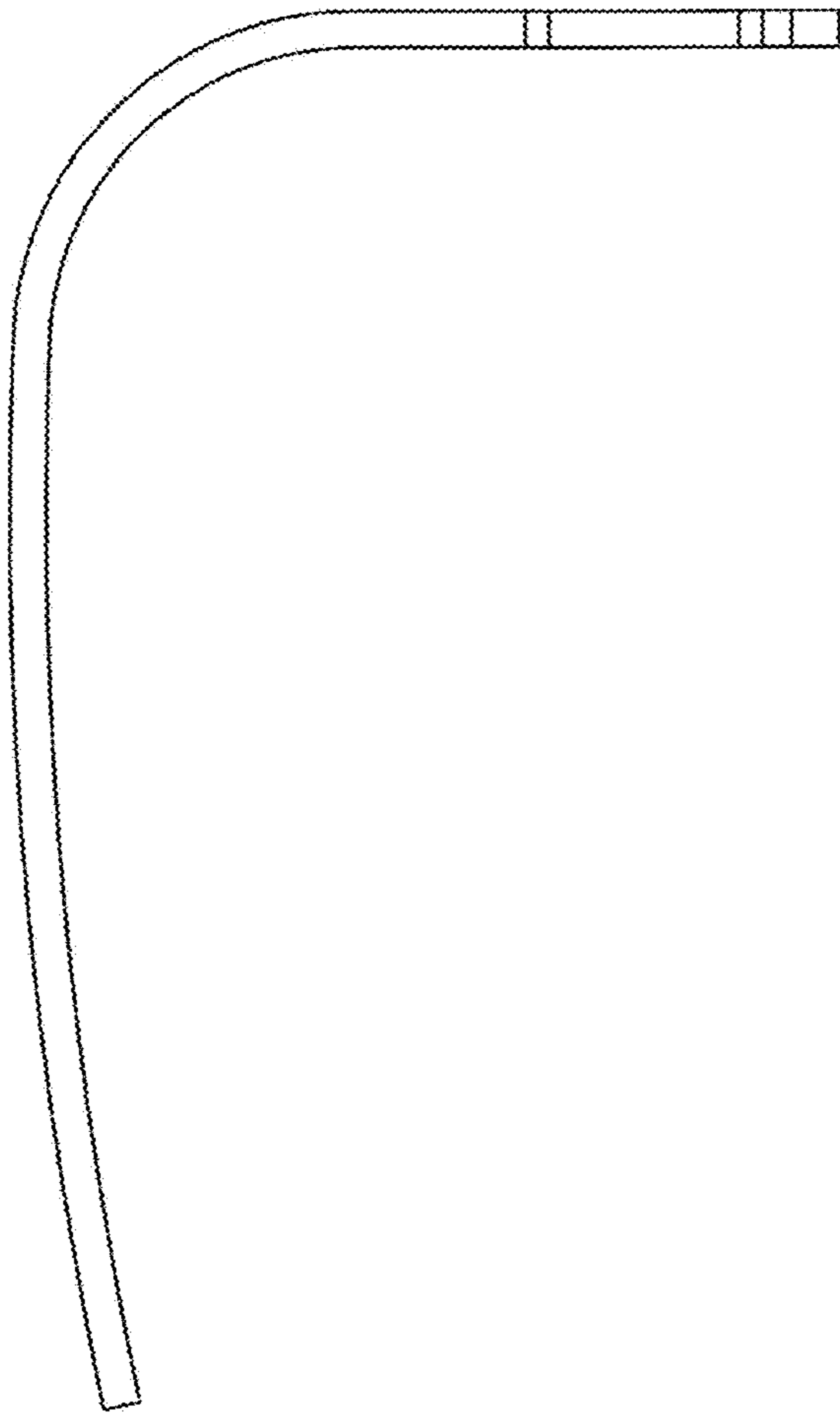

Figure 6

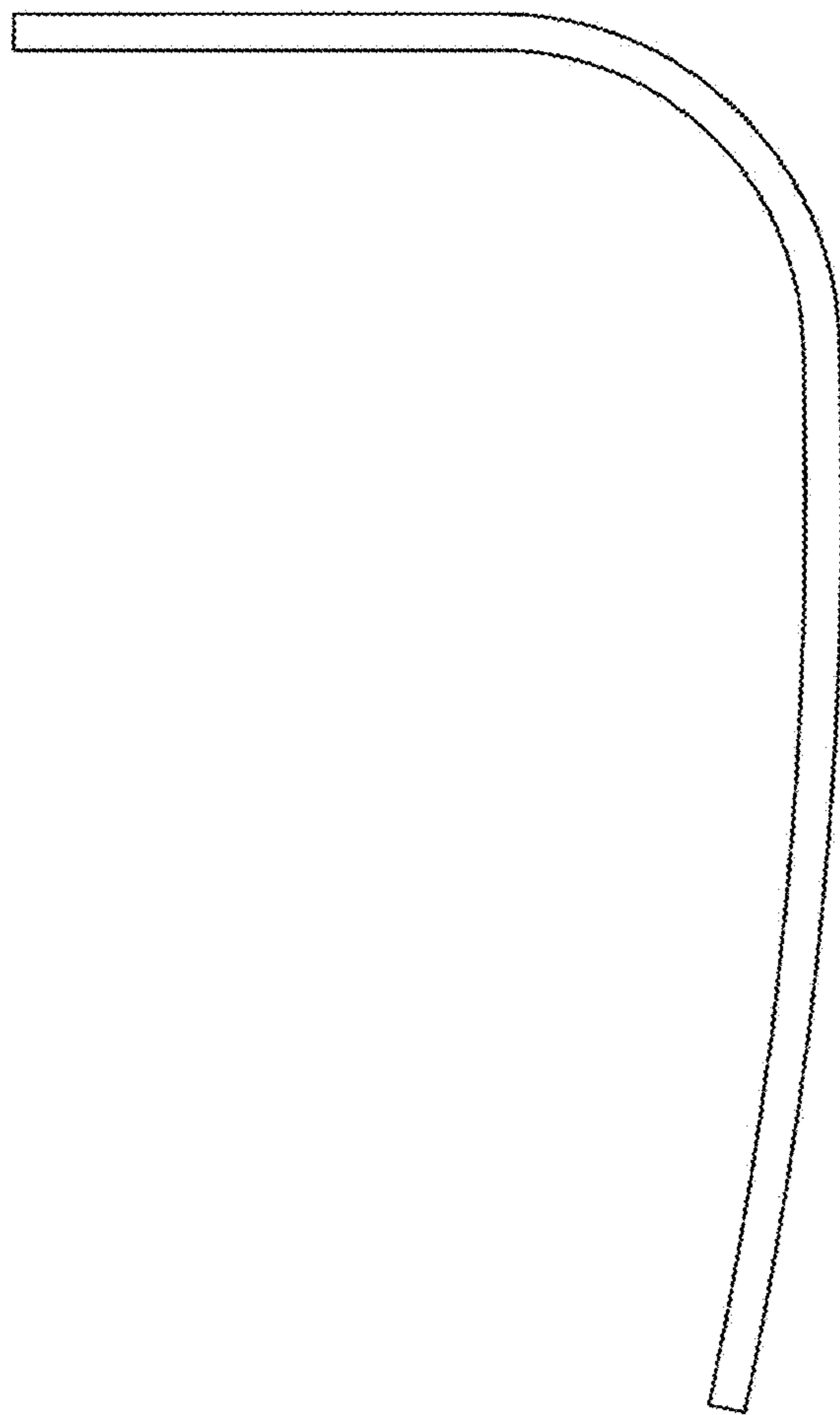

Figure 7

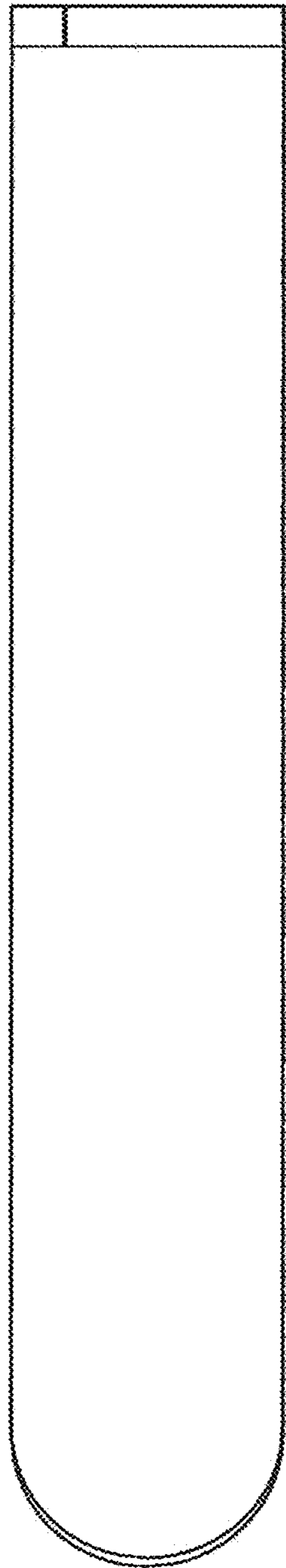

Figure 8

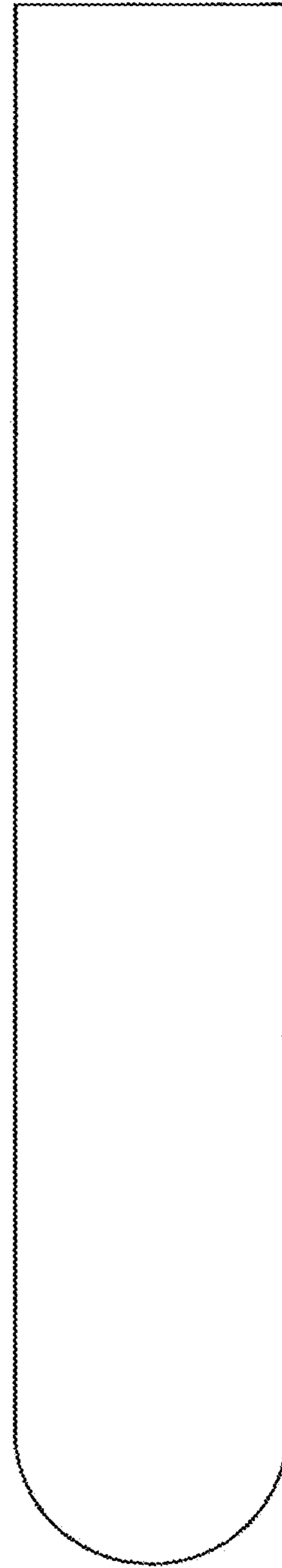

Figure 9

