



US00D815787S

(12) **United States Design Patent** (10) **Patent No.:** **US D815,787 S**  
**Seiders et al.** (45) **Date of Patent:** **\*\* Apr. 17, 2018**

(54) **BUCKET**  
(71) Applicant: **YETI Coolers, LLC**, Austin, TX (US)  
(72) Inventors: **Roy Joseph Seiders**, Austin, TX (US);  
**Andy Bondhus**, Austin, TX (US);  
**Steve Charles Nichols**, Austin, TX  
(US); **Andrew M. Bosway**, Austin, TX  
(US); **Tobias Hotchkiss**, Austin, TX  
(US); **Dennis Zuck**, Austin, TX (US)

4,767,015 A 8/1988 Ho  
4,887,735 A 12/1989 Illingworth  
4,890,355 A 1/1990 Schulten  
4,911,295 A 3/1990 Venegoni  
D307,342 S 4/1990 Giallourakis  
4,993,551 A 2/1991 Lindsay  
5,158,193 A 10/1992 Chen

(Continued)

(73) Assignee: **YETI Coolers, LLC**, Austin, TX (US)

(\*\*) Term: **15 Years**

(21) Appl. No.: **29/595,341**

(22) Filed: **Feb. 27, 2017**

(51) **LOC (11) Cl.** ..... **07-07**

(52) **U.S. Cl.**  
USPC ..... **D32/53**

(58) **Field of Classification Search**  
USPC ..... D32/53, 53.1, 54; D22/136; 15/264;  
220/904, 694-697, 369, 370, 731, 733  
CPC .. A47L 13/58; A47J 47/18; B65F 1/14; B44D  
3/128; B44D 3/123  
See application file for complete search history.

(56) **References Cited**

**U.S. PATENT DOCUMENTS**

1,486,676 A 3/1924 Nilssen  
1,781,583 A 11/1930 Hodgson  
2,018,271 A 10/1935 Samuel  
2,448,894 A 9/1948 Laus  
2,757,405 A 8/1956 Edwards  
3,535,382 A 10/1970 Brown et al.  
4,356,930 A 11/1982 Roper  
4,524,882 A 6/1985 Buc  
D289,455 S 4/1987 Freiler  
4,667,843 A 5/1987 Galer  
D296,525 S 7/1988 Siegel  
4,765,472 A 8/1988 Dent

**FOREIGN PATENT DOCUMENTS**

CN 102849303 A 1/2013  
CN 203186671 U 9/2013

(Continued)

**OTHER PUBLICATIONS**

“Utility Pail 5 Gallon by Seachoice Products,” published prior to this application’s filing date of Feb. 27, 2017, retrieved from [https://www.amazon.com/Utility-Pail-Gallon-Seachoice-Products/dp/B002IZFOGK/ref=sr\\_1\\_79?ie=UTF8&qid=1483581180&sr=8-79&keywords=utility+pail](https://www.amazon.com/Utility-Pail-Gallon-Seachoice-Products/dp/B002IZFOGK/ref=sr_1_79?ie=UTF8&qid=1483581180&sr=8-79&keywords=utility+pail) on Jun. 8, 2017.

(Continued)

*Primary Examiner* — Robin V Webster  
(74) *Attorney, Agent, or Firm* — Banner & Witcoff, Ltd.

(57) **CLAIM**

The ornamental design for a bucket, as shown and described.

**DESCRIPTION**

FIG. 1 is a top, front, right perspective view of a bucket showing our new design;  
FIG. 2 is a front view thereof;  
FIG. 3 is a rear view thereof;  
FIG. 4 is a right side view thereof;  
FIG. 5 is a left side view thereof;  
FIG. 6 is a top view thereof; and,  
FIG. 7 is a bottom view thereof.

**1 Claim, 7 Drawing Sheets**

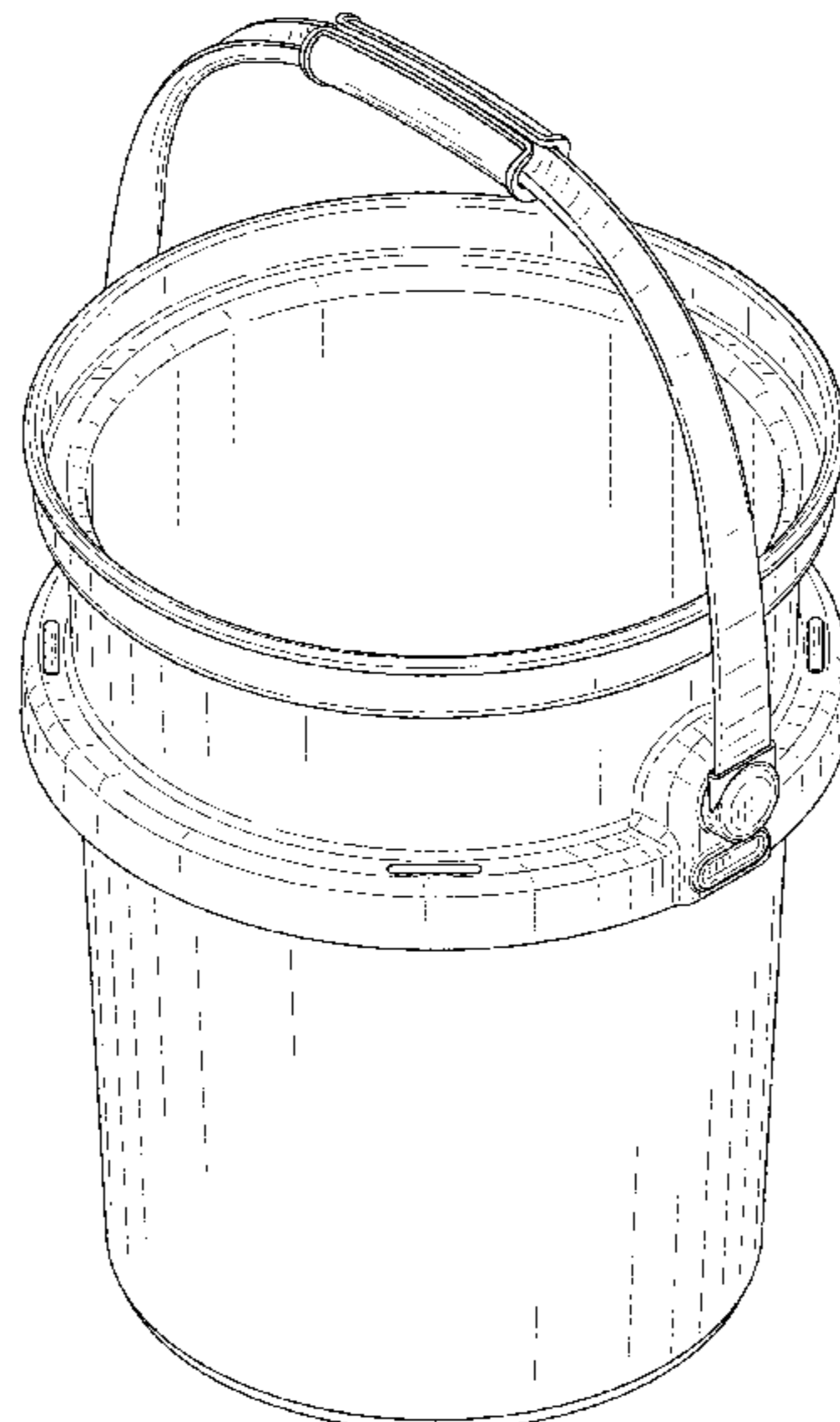

(56)

## References Cited

## U.S. PATENT DOCUMENTS

5,174,447 A 12/1992 Fleming  
 5,238,135 A 8/1993 Landis  
 D352,143 S \* 11/1994 Arshinoff ..... D32/53  
 5,364,148 A 11/1994 Bartocci  
 D355,735 S 2/1995 Shaffer et al.  
 5,411,307 A 5/1995 Roberts  
 D362,181 S 9/1995 Meyers et al.  
 D365,506 S 12/1995 Spitere  
 D371,185 S 6/1996 Mullins  
 D386,341 S 11/1997 Walker  
 D389,058 S 1/1998 Landis  
 5,704,496 A 1/1998 Latta  
 5,730,309 A 3/1998 Jiradejnunt et al.  
 5,738,401 A 4/1998 Fan  
 5,816,439 A 10/1998 Lovell et al.  
 5,833,095 A 11/1998 Russell et al.  
 D402,986 S 12/1998 Doak  
 5,860,559 A 1/1999 Wang  
 5,873,482 A 2/1999 Conti  
 5,921,017 A 7/1999 Clark et al.  
 5,971,200 A 10/1999 Reynolds  
 D425,600 S 5/2000 Pas et al.  
 6,059,109 A 5/2000 Stein  
 6,085,902 A 7/2000 Fang  
 6,151,910 A 11/2000 Hazen  
 6,189,697 B1 2/2001 Davis  
 6,257,440 B1 7/2001 Perkins et al.  
 D446,617 S 8/2001 Urbanski  
 6,336,255 B1 1/2002 Gallup  
 6,533,227 B1 3/2003 Rom  
 6,536,590 B1 3/2003 Godshaw et al.  
 6,688,483 B2 2/2004 Davis  
 D493,929 S \* 8/2004 Schwarz ..... D32/53  
 6,823,562 B1 11/2004 Smith et al.  
 6,926,165 B2 8/2005 Conti  
 6,938,761 B2 9/2005 Nish  
 6,964,348 B2 11/2005 Breimon et al.  
 7,073,205 B2 7/2006 Finn  
 7,090,088 B2 8/2006 von Holdt, Jr.  
 7,207,457 B2 4/2007 Schwarz  
 7,232,169 B2 6/2007 Porter  
 7,305,793 B1 12/2007 Macdonald  
 D590,561 S \* 4/2009 Baltz ..... D32/53  
 7,805,813 B1 10/2010 Bunyard  
 7,980,415 B2 7/2011 Crawley  
 D649,726 S \* 11/2011 Manuel ..... D32/53  
 8,079,768 B1 12/2011 McLaughlin  
 8,162,165 B2 4/2012 Reed  
 8,181,819 B2 5/2012 Burney et al.  
 8,210,391 B2 7/2012 Luburic  
 8,251,269 B2 8/2012 Winneur  
 8,308,010 B2 11/2012 Letica et al.  
 8,342,350 B2 1/2013 Jain  
 D677,895 S 3/2013 Camp, III  
 D683,510 S \* 5/2013 Schick ..... D32/53  
 8,459,486 B2 6/2013 Luburic et al.  
 D688,592 S 8/2013 Placencia  
 8,615,921 B1 12/2013 Weems  
 D698,939 S 2/2014 Wainwright et al.  
 8,662,300 B1 3/2014 Arena  
 8,714,403 B2 5/2014 Amprimo  
 8,806,803 B1 8/2014 Mitchell et al.  
 8,863,982 B2 10/2014 Baltz et al.  
 8,863,983 B2 10/2014 Meers et al.  
 8,869,985 B2 10/2014 Schick  
 D722,833 S 2/2015 Miller  
 8,978,194 B1 3/2015 Lentine  
 D726,984 S \* 4/2015 Lewison ..... D32/53  
 D728,882 S 5/2015 Tsai  
 9,067,462 B1 6/2015 Pressler et al.  
 D739,510 S 9/2015 Bullock  
 D772,561 S 11/2016 Polunsky et al.  
 9,533,789 B2 1/2017 Selina et al.  
 2002/0003098 A1 1/2002 Bell  
 2002/0088729 A1 7/2002 Urbanski

2004/0045084 A1 3/2004 Klosterman  
 2005/0051441 A1 3/2005 Lamar  
 2005/0056557 A1 3/2005 Jennings et al.  
 2005/0133521 A1 6/2005 Schwarz  
 2005/0279654 A1 12/2005 Robles  
 2006/0163894 A1 7/2006 Mishek et al.  
 2007/0246959 A1 10/2007 Arcaro et al.  
 2008/0105694 A1 5/2008 Chen  
 2009/0301912 A1 12/2009 Cornell  
 2011/0000919 A1 1/2011 Whalen  
 2012/0085774 A1 4/2012 Luburic et al.  
 2012/0279976 A1 11/2012 DeSanti et al.  
 2013/0037559 A1 2/2013 Fierek  
 2013/0048657 A1 2/2013 Heiser, Jr. et al.  
 2013/0119078 A1 5/2013 Cygan  
 2013/0248284 A1 9/2013 Nichols, Jr.  
 2014/0102925 A1 4/2014 Jacobson et al.  
 2014/0124520 A1 5/2014 Allan  
 2014/0217095 A1 8/2014 Scivoletto  
 2014/0326189 A1 11/2014 Jain  
 2015/0001121 A1 1/2015 Pietruch et al.  
 2015/0053705 A1 2/2015 Wilson et al.  
 2015/0107149 A1 4/2015 Garrett  
 2015/0217903 A1 8/2015 Mazyck, III  
 2015/0225125 A1 8/2015 Martinisko  
 2016/0228756 A1 8/2016 Siscoe  
 2016/0311584 A1 10/2016 Van Oosten  
 2016/0368133 A1 12/2016 Welfel et al.

## FOREIGN PATENT DOCUMENTS

CN 103662246 A 3/2014  
 CN 303149621 4/2015  
 CN 303214602 5/2015  
 CN 303245878 6/2015  
 CN 303263716 7/2015  
 CN 303284668 7/2015  
 CN 303284683 7/2015  
 CN 303295744 7/2015  
 CN 303295746 7/2015  
 CN 303316701 8/2015  
 CN 303316702 8/2015  
 CN 303316749 8/2015  
 CN 303316750 8/2015  
 CN 303316751 8/2015  
 CN 303336476 8/2015  
 CN 303345543 8/2015  
 CN 303517355 12/2015  
 CN 303899235 10/2016  
 CN 303910969 11/2016  
 DE 202009009198 U1 11/2009  
 DE 20201320100609 U1 11/2013  
 EP 779018 A 7/1957  
 EP 2130777 A2 12/2009  
 JP 3116035 U 11/2005  
 KR 200472092 Y1 4/2014

## OTHER PUBLICATIONS

“United Solutions PN0020 White Five Gallon Plastic Industrial Pail—5 Gallon Plastic Bucket for Industrial in White,” published prior to this application’s filing date of Feb. 27, 2017, retrieved from [https://www.amazon.com/United-Solutions-PN0020-Plastic-Industrial/dp/B005SB1ORY/ref=sr\\_1\\_88?ie=UTF8&qid=1483581247&sr=8-88&keywords=utility+pail](https://www.amazon.com/United-Solutions-PN0020-Plastic-Industrial/dp/B005SB1ORY/ref=sr_1_88?ie=UTF8&qid=1483581247&sr=8-88&keywords=utility+pail) on Jun. 8, 2017.  
 “Bucket Stacker Tool Organize with 4 Compartments, 3" Deep,” published prior to this application’s filing date of Feb. 27, 2017, retrieved from <http://www.all-spec.com/Catalog/Hand-Power-Tools/Pneumatic-Tools/Tool-Arms-Holders/15051-65685?gclid=Clrk0-n0qtECFUhWDQod6w4JOg> on Jun. 8, 2017.  
 “Built-in Bottom Handle 5 Gallon Buckets & Covers,” published prior to this application’s filing date of Feb. 27, 2017, retrieved from <http://www.usplastic.com/catalog/item.aspx?itemid=118844&catid=752> on Jun. 8, 2017.  
 “The Ultimate Bucket,” published prior to the filing date of this application on Feb. 27, 2017, retrieved from <https://web.archive.org/web/20111027180918/http://ultimatebucket.com:80/index.html> on Jun. 21, 2017.

(56)

**References Cited**

## OTHER PUBLICATIONS

“Custom Leathercraft 1118 30-Pocket Outside Bucket-Pockets,” published prior to Mar. 23, 2017, retrieved from [https://www.walmart.com/ip/Custom-Leathercraft-1118-30-Pocket-Outside-Bucket-Pockets/19656756?action=product\\_interest&action\\_type=title&beacon\\_version=1.0.2&bucket\\_id=irsbucketdefault&client\\_guid=62111ea2-f303-4793-8529-5a53e4d809c9&config\\_id=2&cu#about-item](https://www.walmart.com/ip/Custom-Leathercraft-1118-30-Pocket-Outside-Bucket-Pockets/19656756?action=product_interest&action_type=title&beacon_version=1.0.2&bucket_id=irsbucketdefault&client_guid=62111ea2-f303-4793-8529-5a53e4d809c9&config_id=2&cu#about-item) on Jun. 5, 2017.

“61—Pocket In and Out Bucket Organizer,” published prior to Mar. 23, 2017, retrieved from <https://www.walmart.com/ip/Custom-Leathercraft-4122-61-Pocket-Bucket-Tool-Bag-61-Pocket-In-Out-Each/21659694> on Jun. 5, 2017.

“Apollo Tools Bucket Organizer, Pink,” published prior to Mar. 23, 2017, retrieved from <https://www.walmart.com/ip/Apollo-Tools-Bucket-Organizer/22848213> on Jun. 5, 2017.

“Apollo Tools Bucket Organizer,” published prior to Mar. 23, 2017, retrieved from <https://www.walmart.com/ip/Apollo-Tools-Bucket-Organizer/22848212> on Jun. 5, 2017.

“Bucket Organizer Wrap Milwaukee Tool Holders 48-22-8175045242479580,” published prior to Mar. 23, 2017, retrieved from <https://www.walmart.com/ip/Bucket-Organizer-Wrap-Milwaukee-Tool-Holders-48-22-8175-045242479580/120876362> on Jun. 5, 2017.

“Fiskars Garden Bucket Caddy, Bucket Not Included (9424),” published prior to Mar. 23, 2017, retrieved from <https://www.amazon.com/Fiskars-Garden-Bucket-Caddy-Included/dp/B00005YX30> on Jun. 5, 2017.

\* cited by examiner

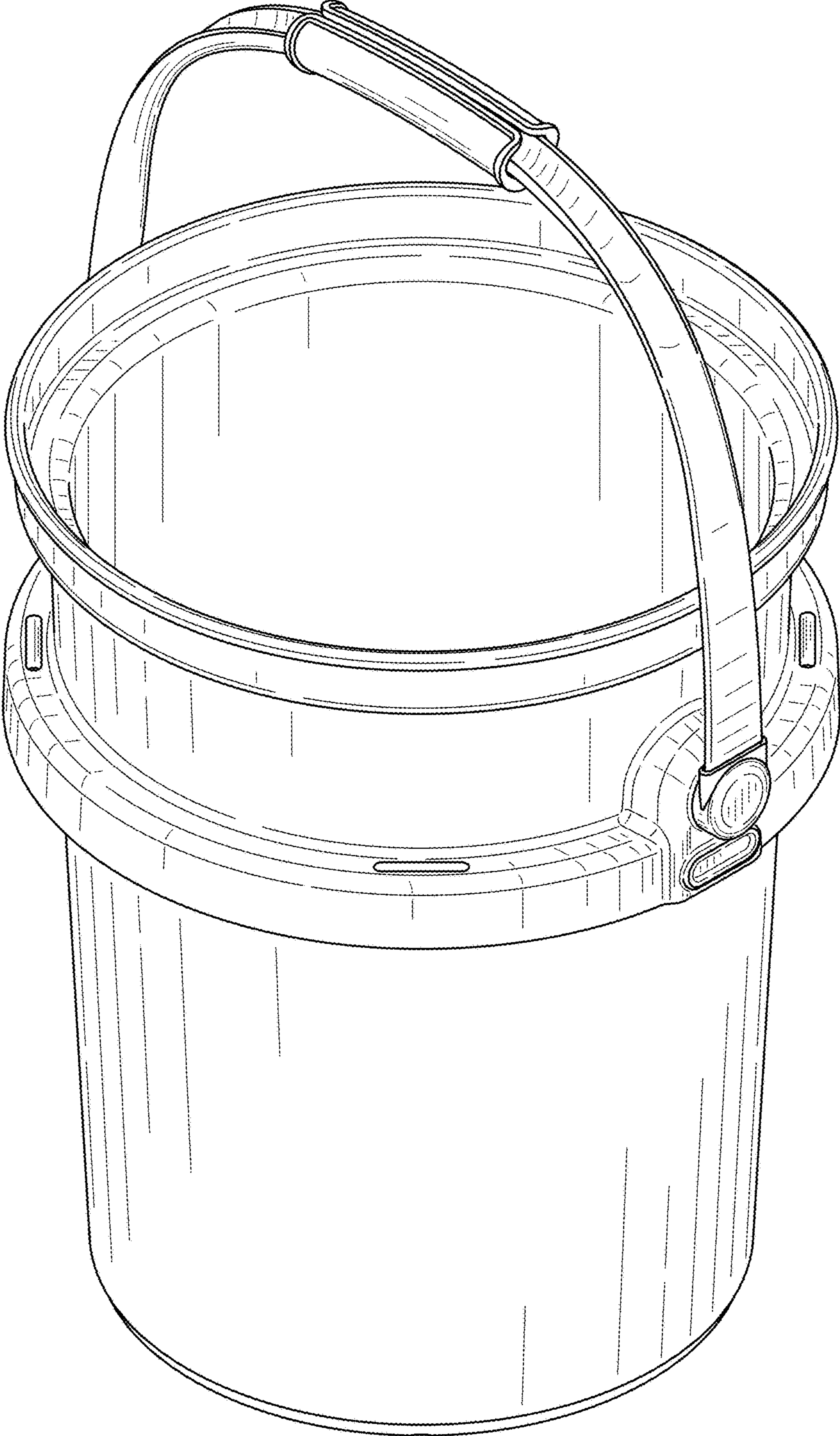

FIG. 1

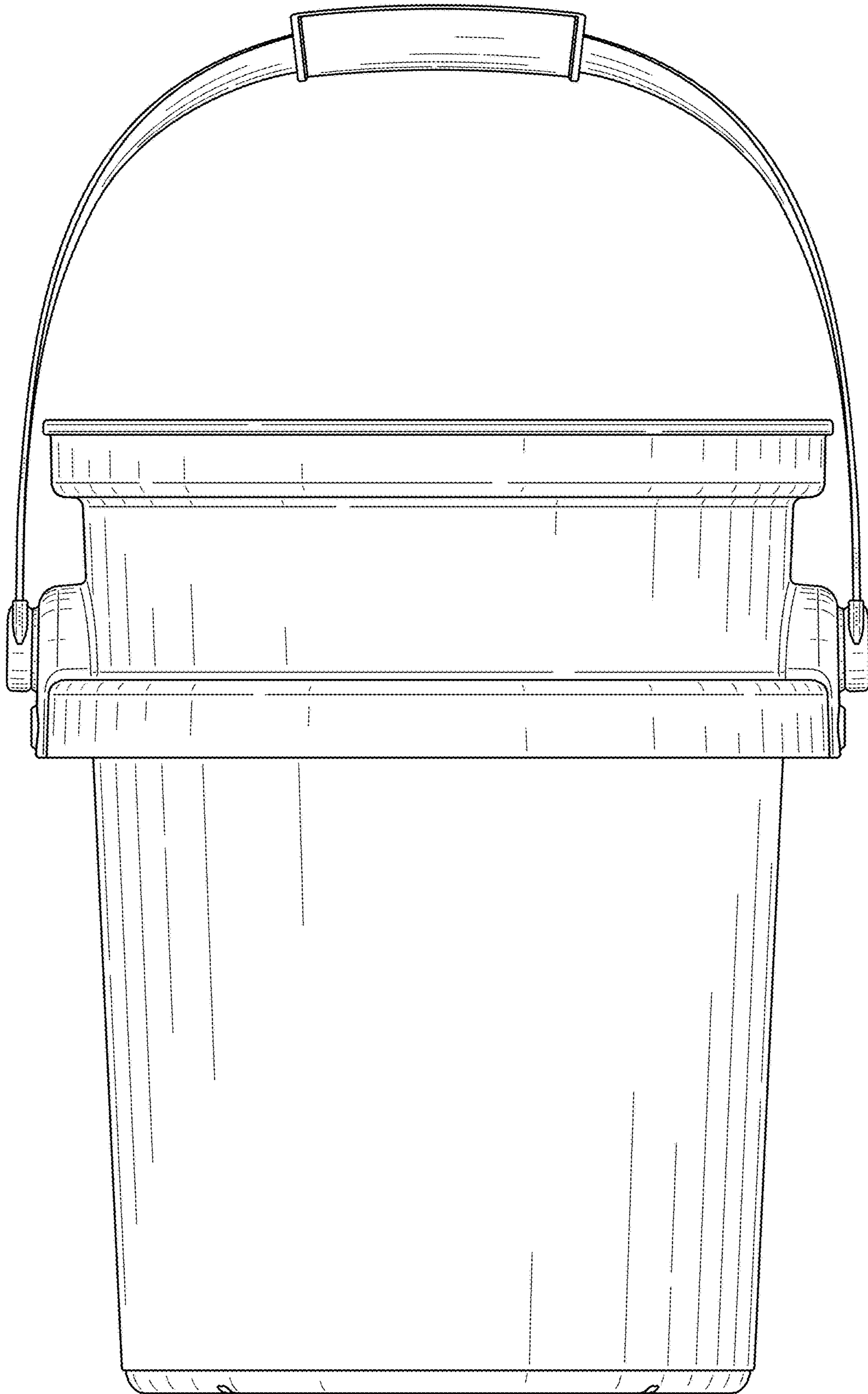

FIG. 2

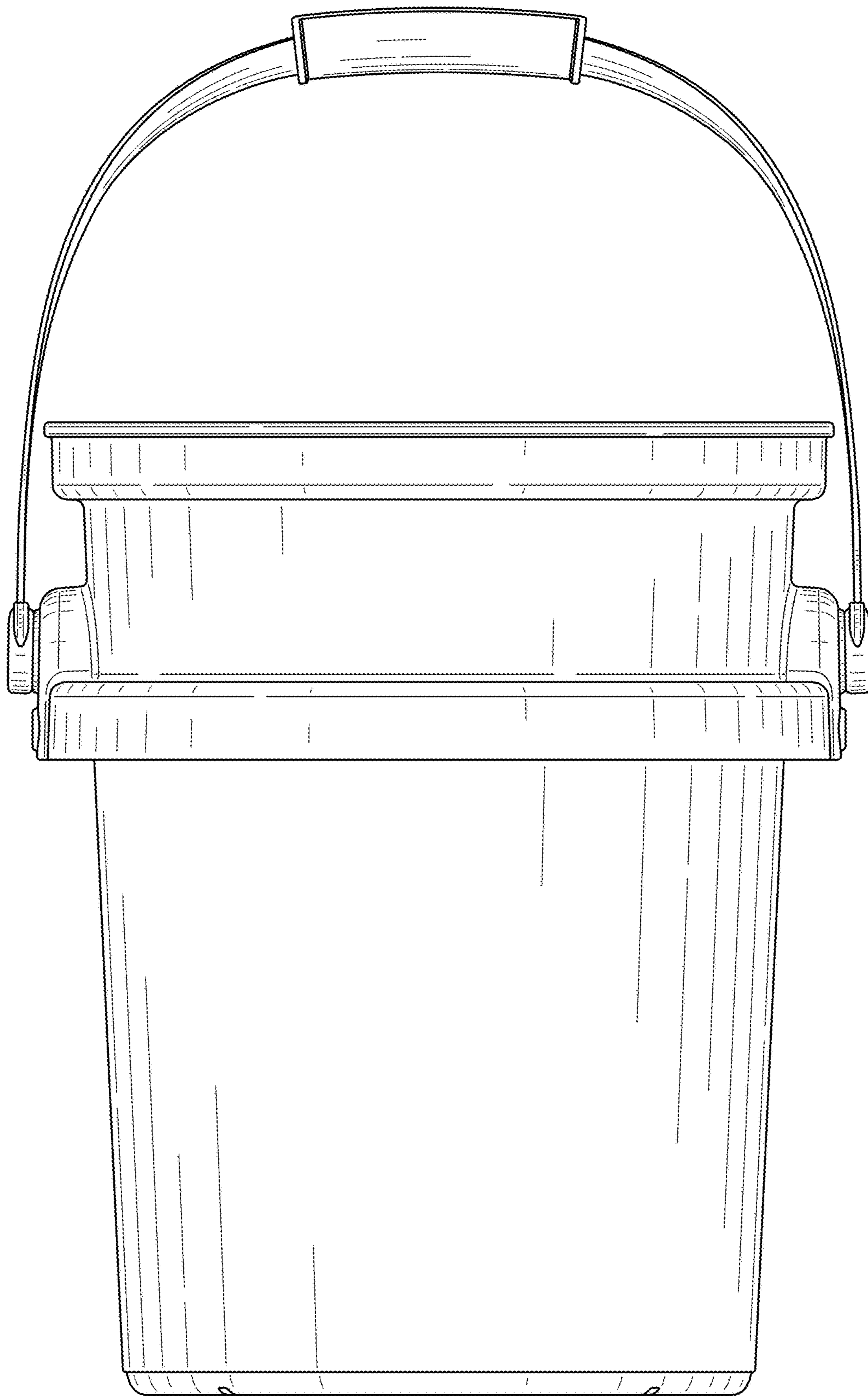

FIG. 3

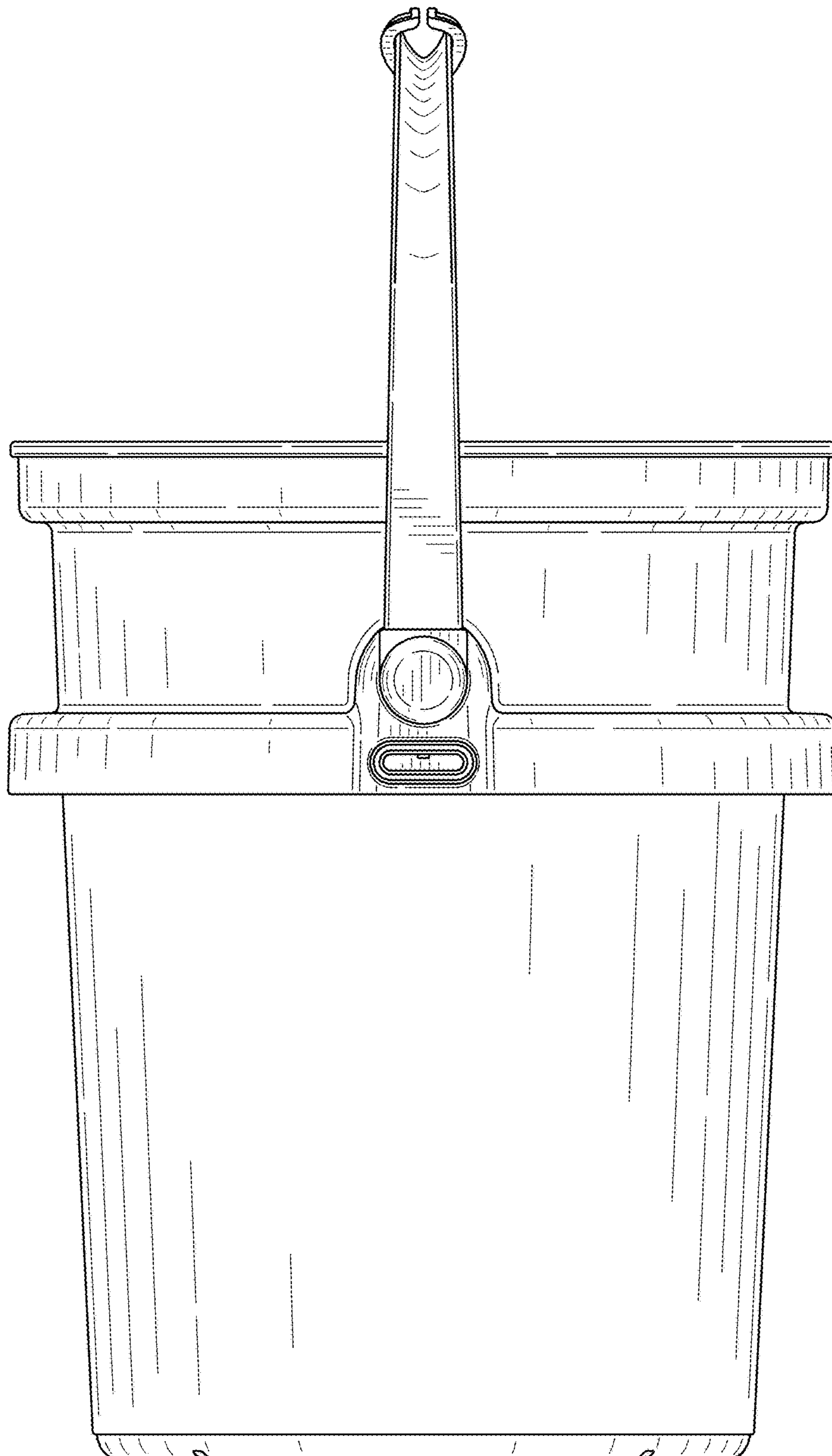

FIG. 4

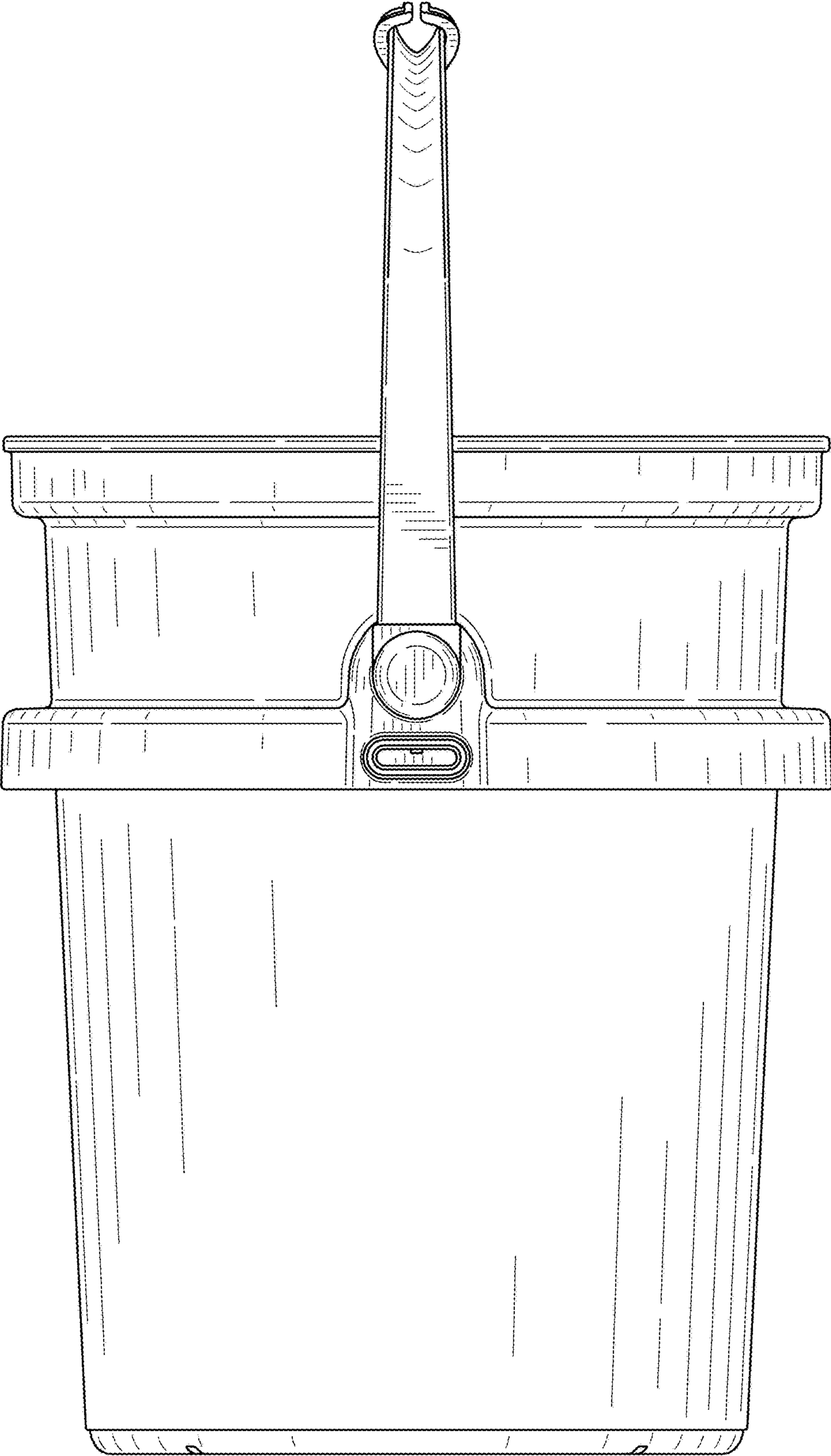

FIG. 5



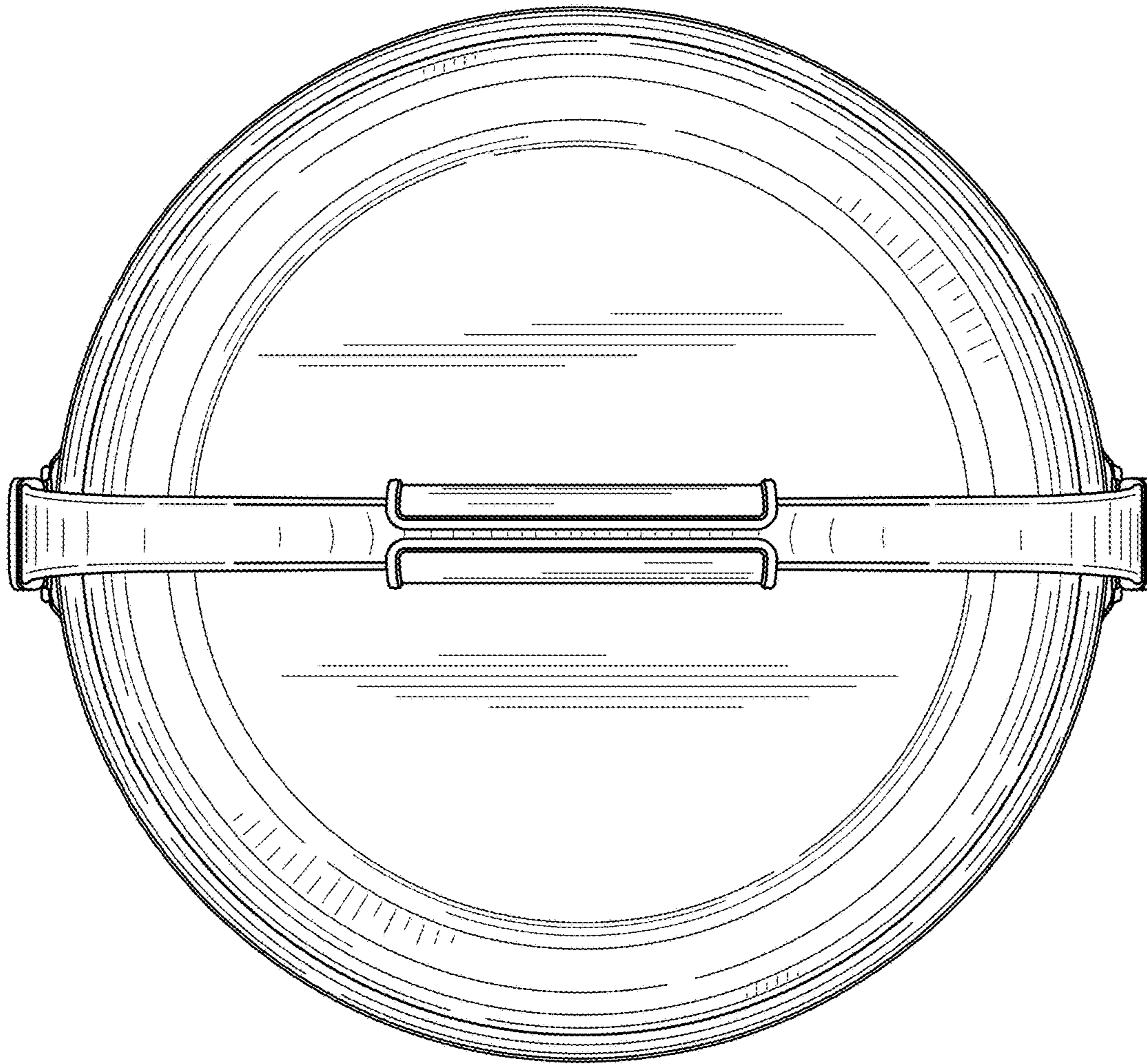

FIG. 6

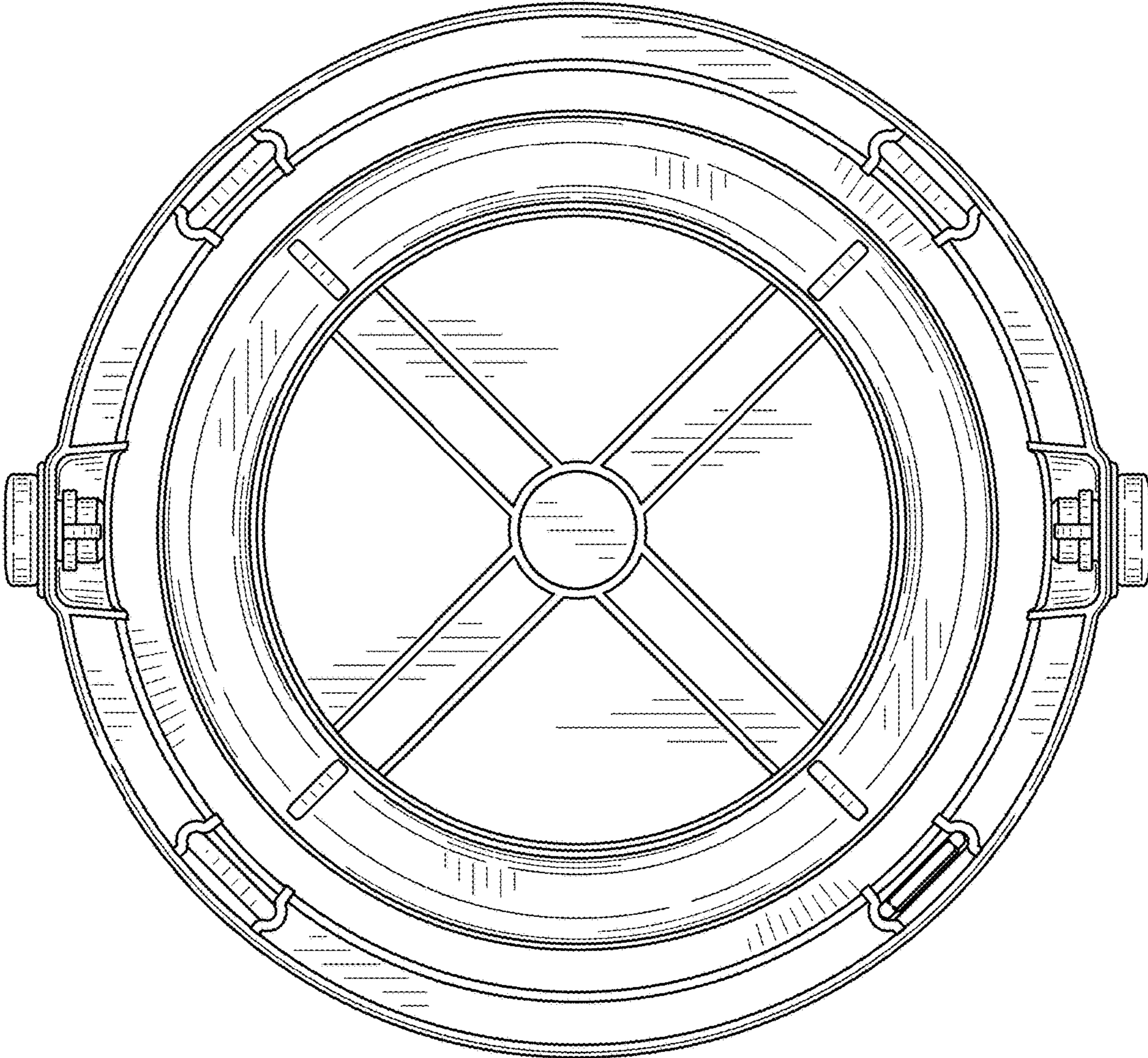

FIG. 7