



US00D815715S

(12) **United States Design Patent**
Seum et al.

(10) **Patent No.:** **US D815,715 S**

(45) **Date of Patent:** **** Apr. 17, 2018**

(54) **WATER GUARD**

(71) Applicant: **Grohe AG**, Hemer (DE)

(72) Inventors: **Michael Seum**, Duesseldorf (DE);
Beguem Tomruk, Duesseldorf (DE)

(73) Assignee: **Grohe AG**, Hemer (DE)

(**) Term: **15 Years**

(21) Appl. No.: **29/604,014**

(22) Filed: **May 15, 2017**

(30) **Foreign Application Priority Data**

Nov. 15, 2016 (EM) 003464171-0002

(51) **LOC (11) Cl.** **23-01**

(52) **U.S. Cl.**
USPC **D23/248**

(58) **Field of Classification Search**
USPC D23/233, 238, 242, 245, 246, 249, 250,
D23/235, 227, 260, 303, 248; 137/382,
137/381, 377, 800, 596.17, 596.2, 446,
137/434, 455, 1; D10/40; 73/46, 700
CPC F16K 27/12; F16K 31/605; F16K 35/10;
F16K 49/00; E03C 2001/321; A47K
3/005; E03B 7/12; F16L 59/161
See application file for complete search history.

(56) **References Cited**

U.S. PATENT DOCUMENTS

D287,043 S * 12/1986 Hughes D23/248
6,006,779 A * 12/1999 Nowlin F16K 31/18
137/434
6,095,187 A * 8/2000 Hotchkiss F15B 11/003
137/596.17
2008/0251601 A1* 10/2008 Nies A01G 25/167
239/65

2013/0255798 A1* 10/2013 McAward E03B 7/071
137/455
2014/0345389 A1* 11/2014 Kim G01L 19/06
73/700
2016/0069475 A1* 3/2016 Hein F16K 37/0075
73/46
2017/0228999 A1* 8/2017 Joyer A47K 3/286

OTHER PUBLICATIONS

Grohe Sense Guard. "Grohe Sense Guard, The smart water controller.", www.pro.grohe.com. Web. Feb. 8, 2018. shown in pp. 1-3, Item 34667 (Year: 2018).*

* cited by examiner

Primary Examiner — Cynthia Ramirez

Assistant Examiner — Gino Colan

(74) *Attorney, Agent, or Firm* — Muncy, Geissler, Olds & Lowe, P.C.

(57) **CLAIM**

The ornamental design for a water guard, as shown and described.

DESCRIPTION

FIG. 1 is a front perspective view of a water guard according to the present invention.

FIG. 2 is a front view of the water guard of FIG. 1.

FIG. 3 is a rear view of the water guard of FIG. 1.

FIG. 4 is a left side view of the water guard of FIG. 1.

FIG. 5 is a right side view of the water guard of FIG. 1.

FIG. 6 is a top view of the water guard of FIG. 1; and,

FIG. 7 is a bottom view of the water guard of FIG. 1.

The broken lines shown in the figures are for the purpose of illustrating environment and form no part of the claimed design.

1 Claim, 7 Drawing Sheets

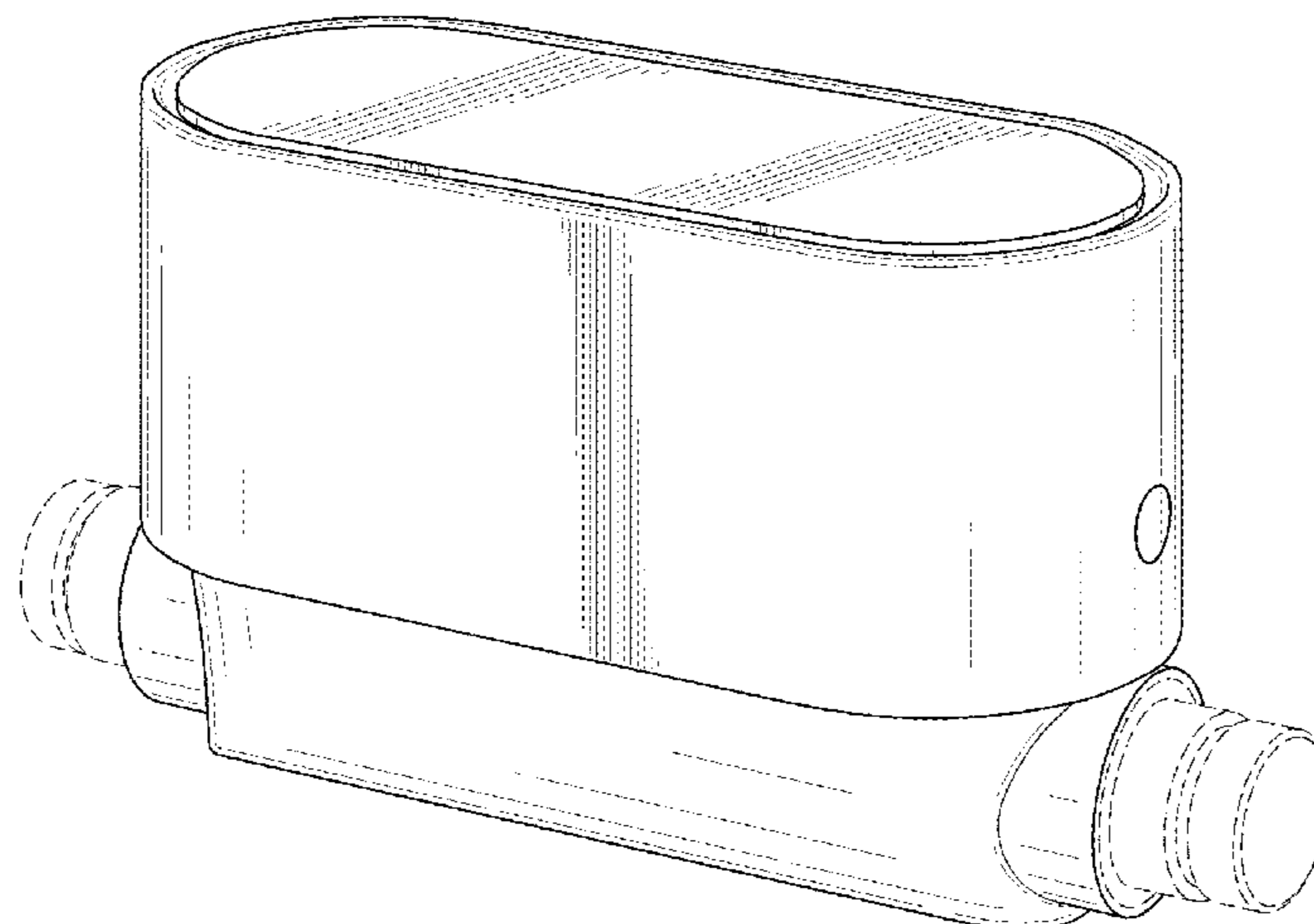

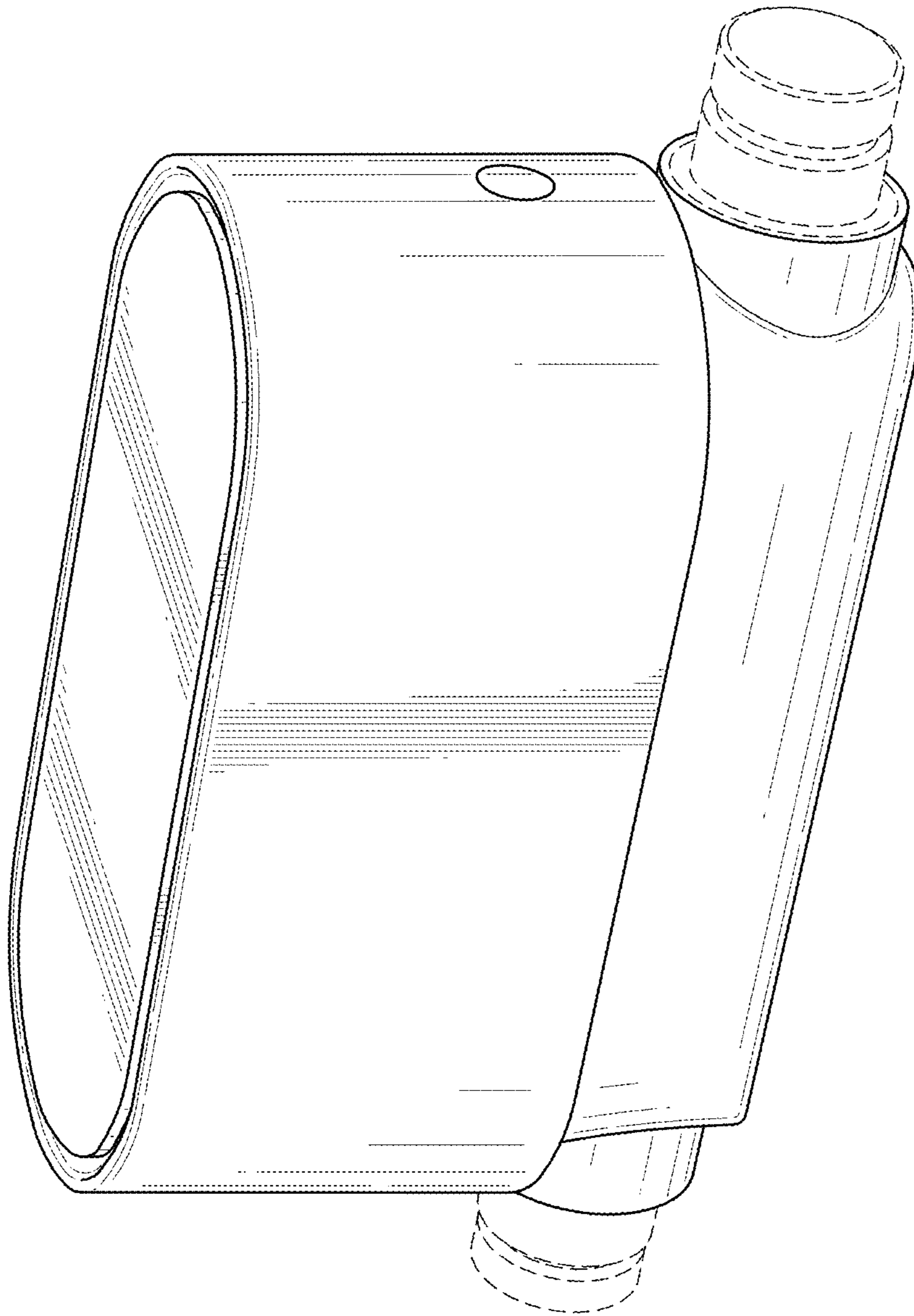

FIG.1

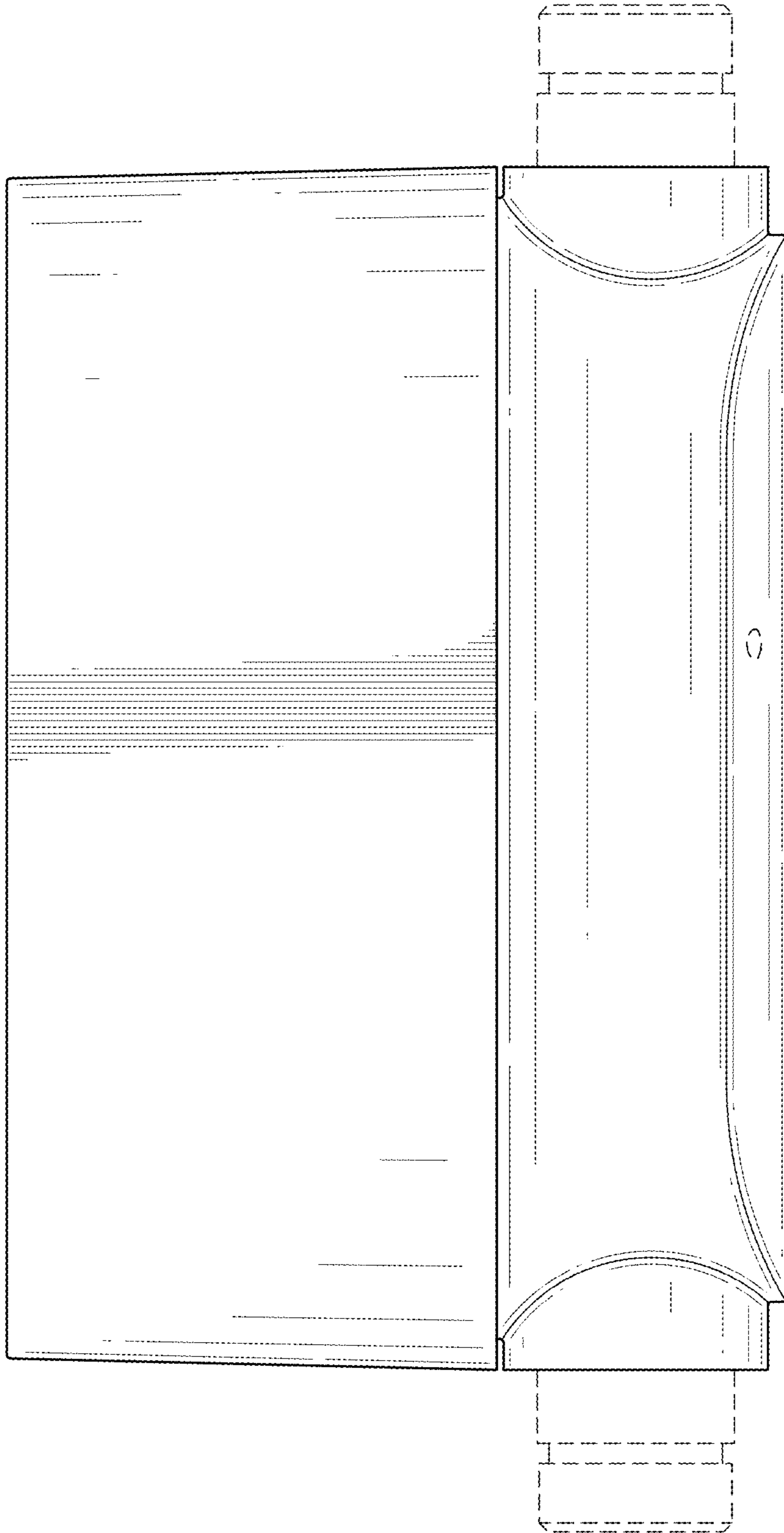

FIG.2

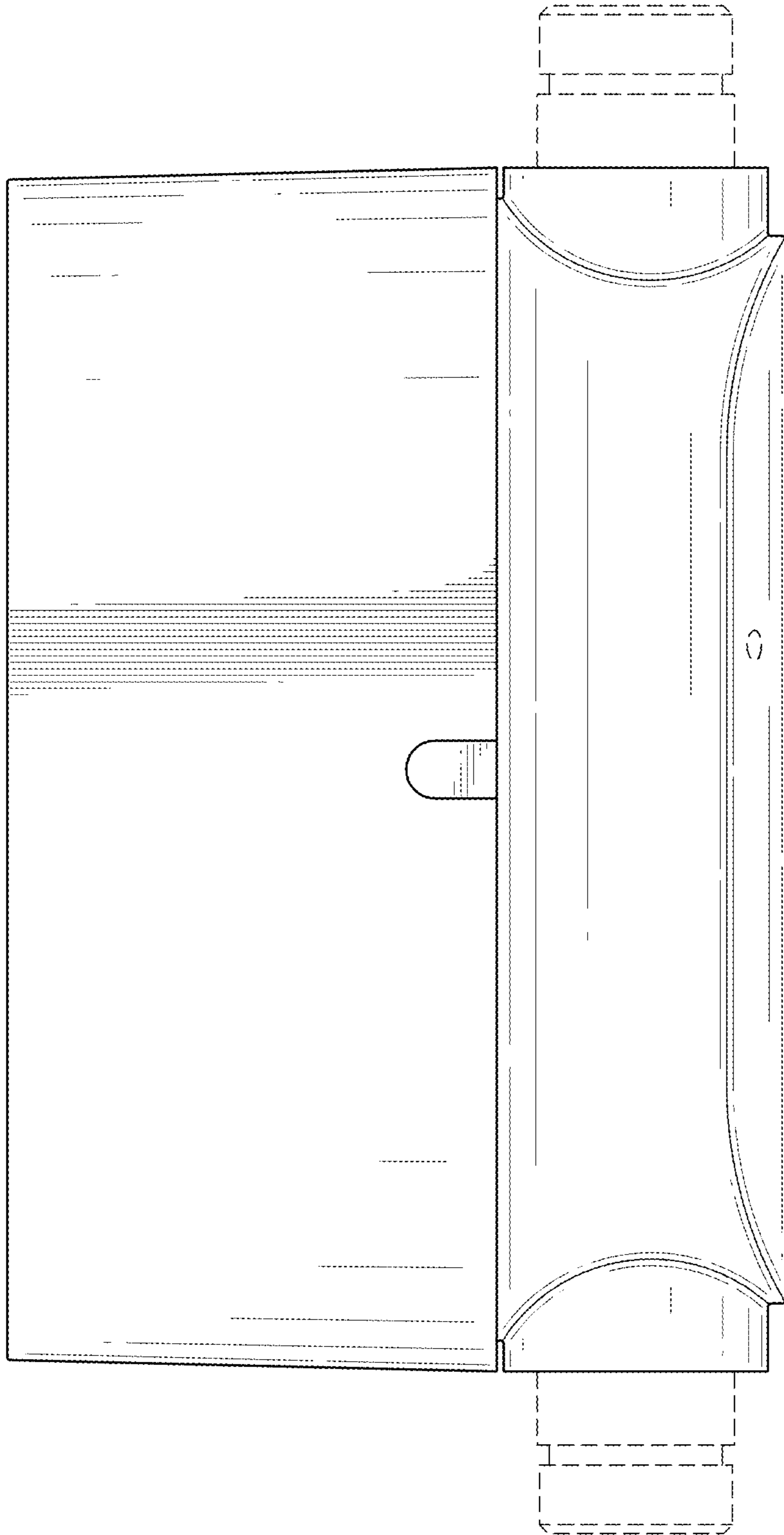

FIG.3

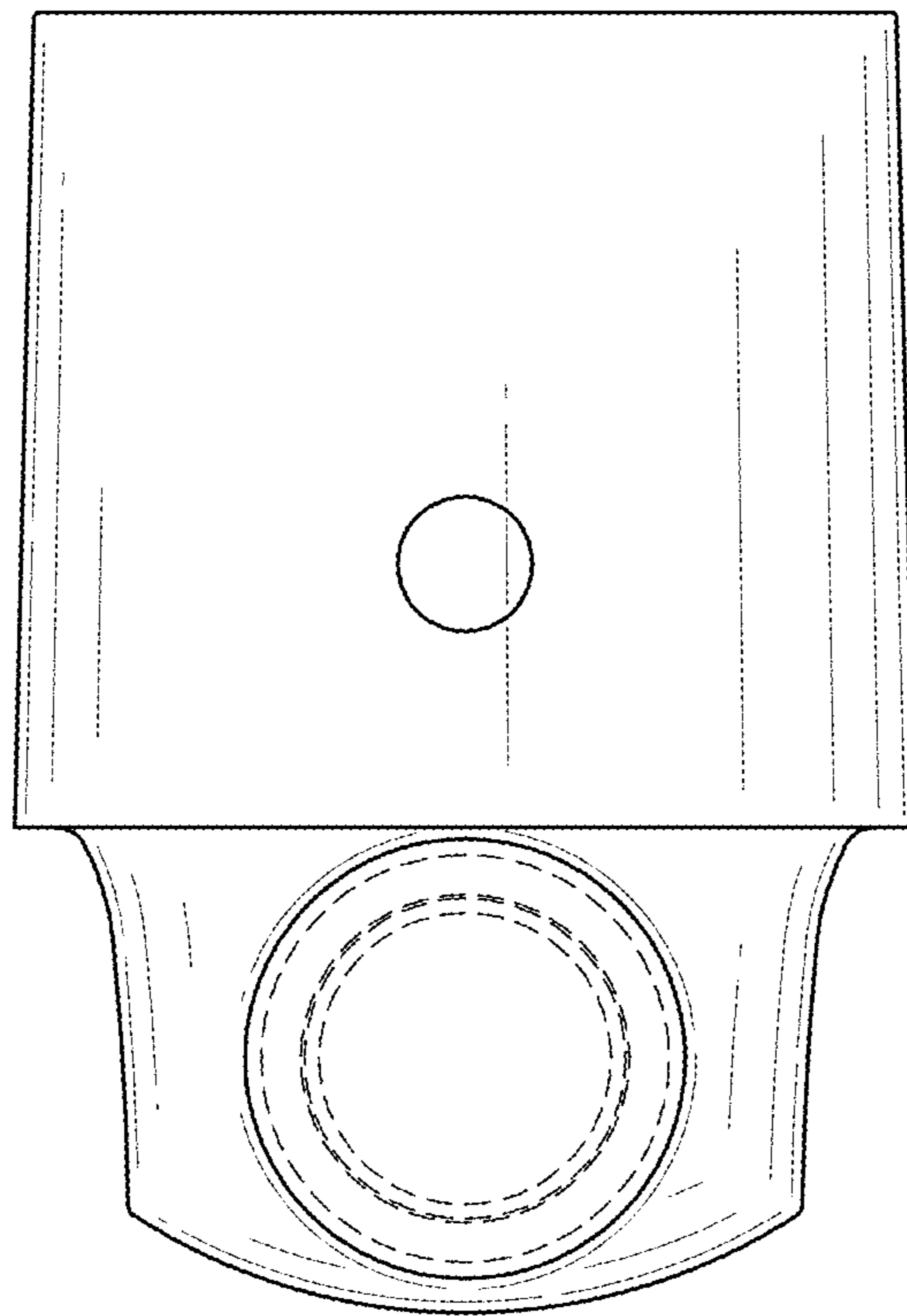

FIG.4

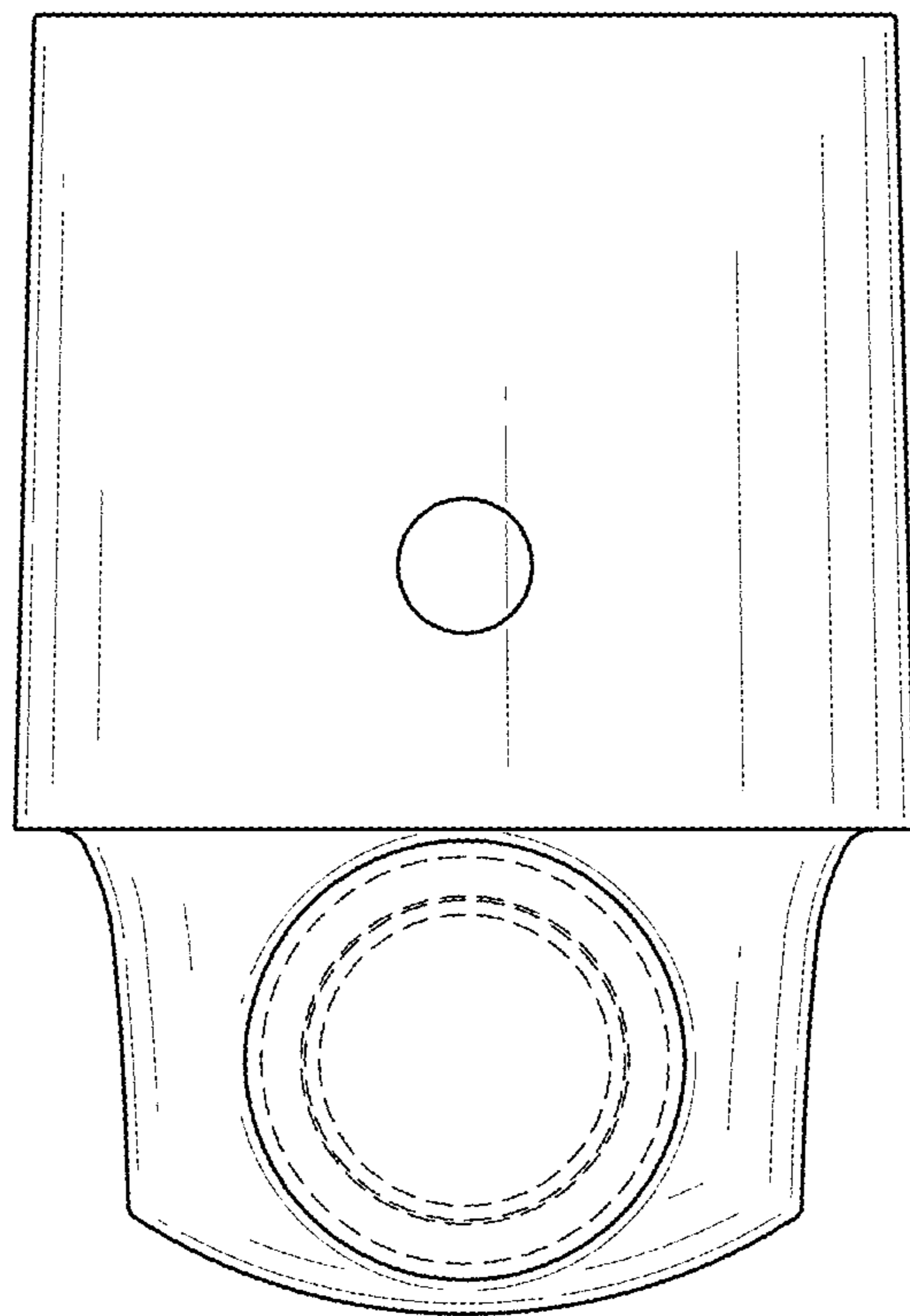

FIG.5

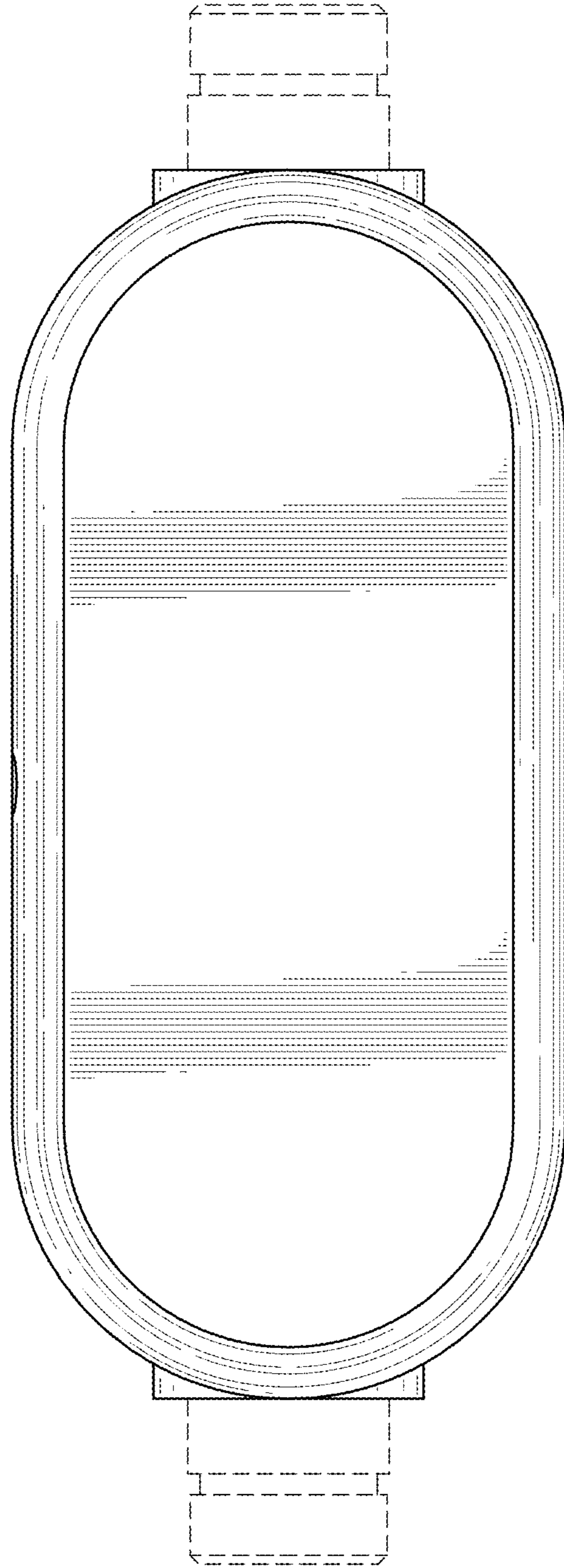

FIG.6

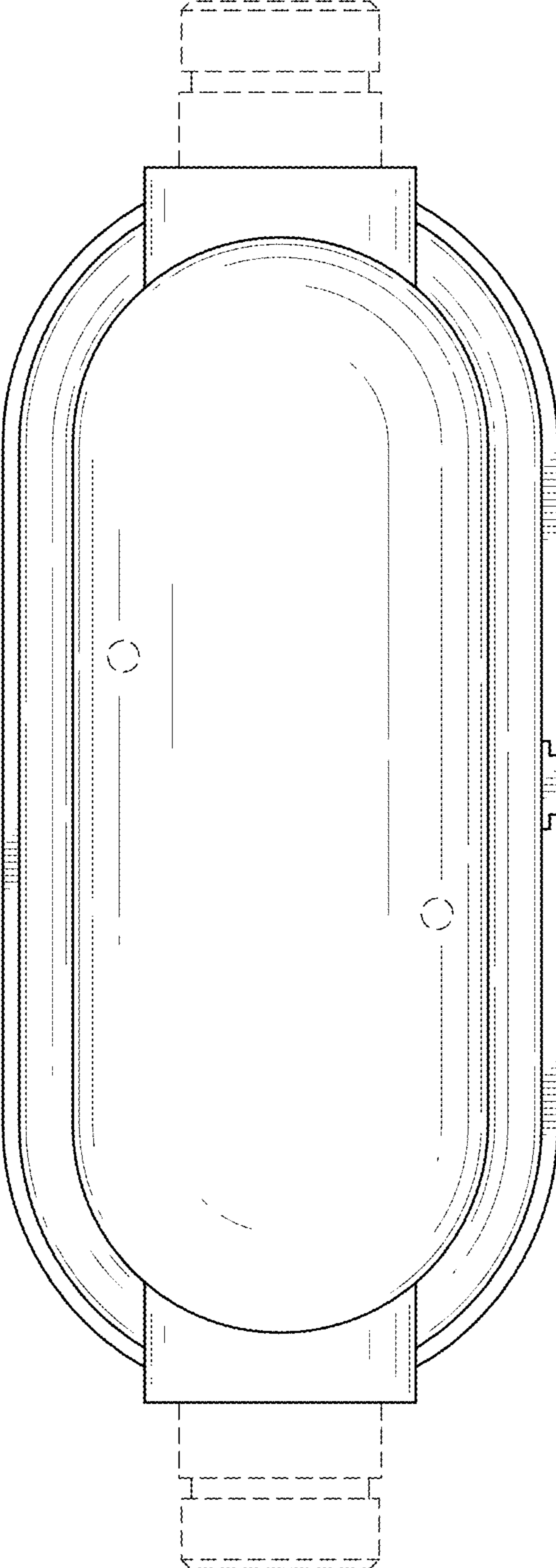

FIG.7