



US00D815582S

(12) **United States Design Patent**
Graff

(10) **Patent No.:** **US D815,582 S**

(45) **Date of Patent:** **** Apr. 17, 2018**

- (54) **TAILGATE TRUNK**
- (71) Applicant: **Erik Graff**, Pittsford, NY (US)
- (72) Inventor: **Erik Graff**, Pittsford, NY (US)
- (**) Term: **15 Years**
- (21) Appl. No.: **29/575,403**
- (22) Filed: **Aug. 24, 2016**
- (51) **LOC (11) Cl.** **12-16**
- (52) **U.S. Cl.**
USPC **D12/414.1**
- (58) **Field of Classification Search**
USPC D12/412, 406, 413, 414, 414.1; D6/552;
D3/304-406
CPC B60R 9/04; B60R 9/045; B60R 9/048
See application file for complete search history.

8,496,146 B2 *	7/2013	Badillo	B60R 9/045	224/310
D772,139 S *	11/2016	Hill	D12/412	
D772,783 S *	11/2016	Schleef	D12/412	
D793,946 S *	8/2017	Badillo	D12/412	
D793,947 S *	8/2017	Badillo	D12/412	
2005/0082326 A1 *	4/2005	Badillo	B60R 9/00	224/326

* cited by examiner

Primary Examiner — Katrina A Betton

(74) *Attorney, Agent, or Firm* — Lee & Hayes, PLLC

(57) **CLAIM**

The ornamental design for a tailgate trunk, as shown and described.

DESCRIPTION

FIG. 1 is a perspective view of a tailgate trunk;
 FIG. 2 is a front view of the tailgate trunk of FIG. 1;
 FIG. 3 is a back view of the tailgate trunk of FIG. 1;
 FIG. 4 is a left-side view of the tailgate trunk of FIG. 1;
 FIG. 5 is a right-side view of the tailgate trunk of FIG. 1;
 FIG. 6 is a top view of the tailgate trunk of FIG. 1; and,
 FIG. 7 is a bottom view of the tailgate trunk of FIG. 1.
 The broken lines are directed to unclaimed portions and form no part of the claimed design.

1 Claim, 7 Drawing Sheets

(56) **References Cited**

U.S. PATENT DOCUMENTS

7,226,266 B2 *	6/2007	Henderson	B60R 9/042	414/462
D578,952 S *	10/2008	Badillo	D12/406	
D603,321 S *	11/2009	Kramer	D12/412	
D624,005 S *	9/2010	Winner	D12/412	

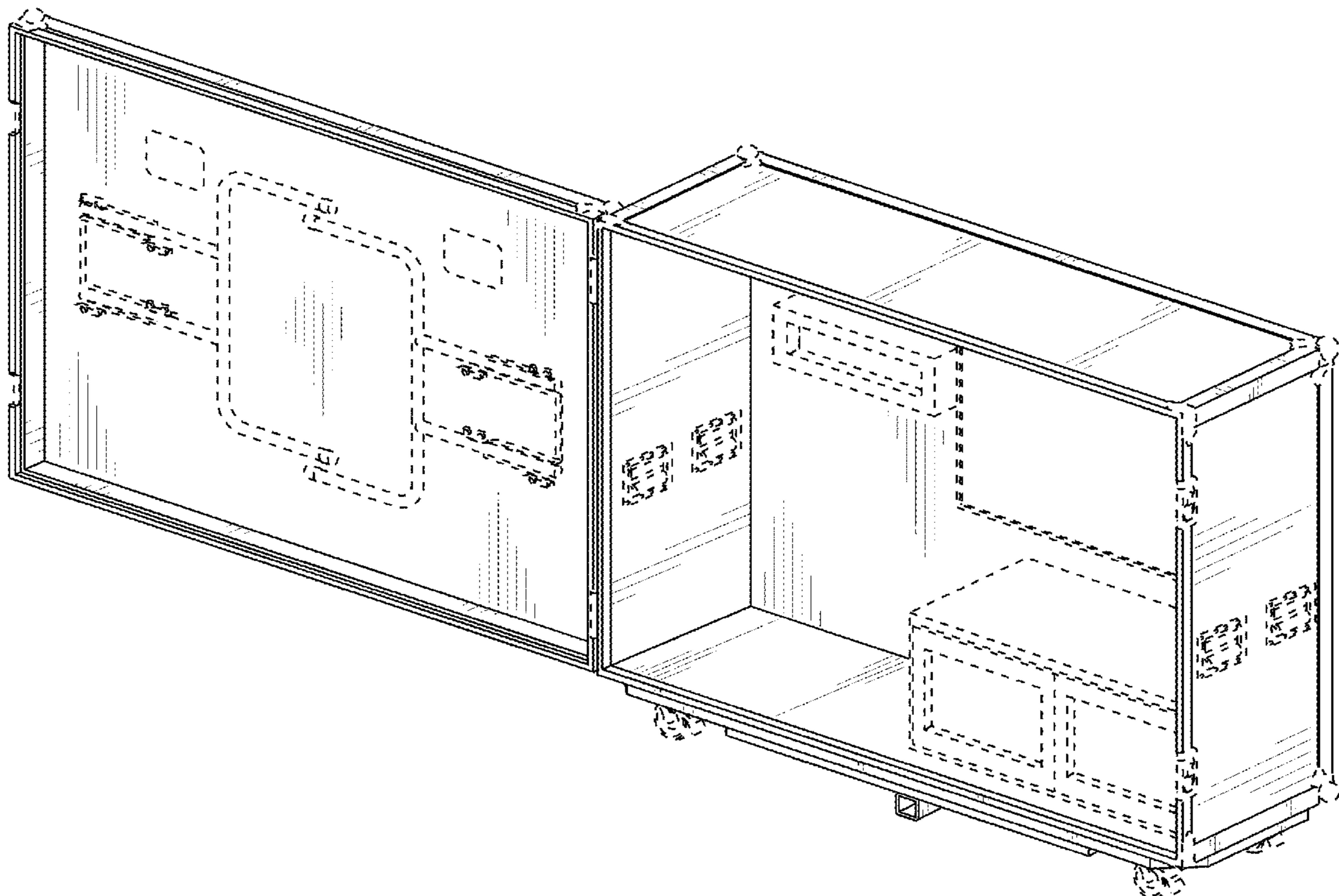

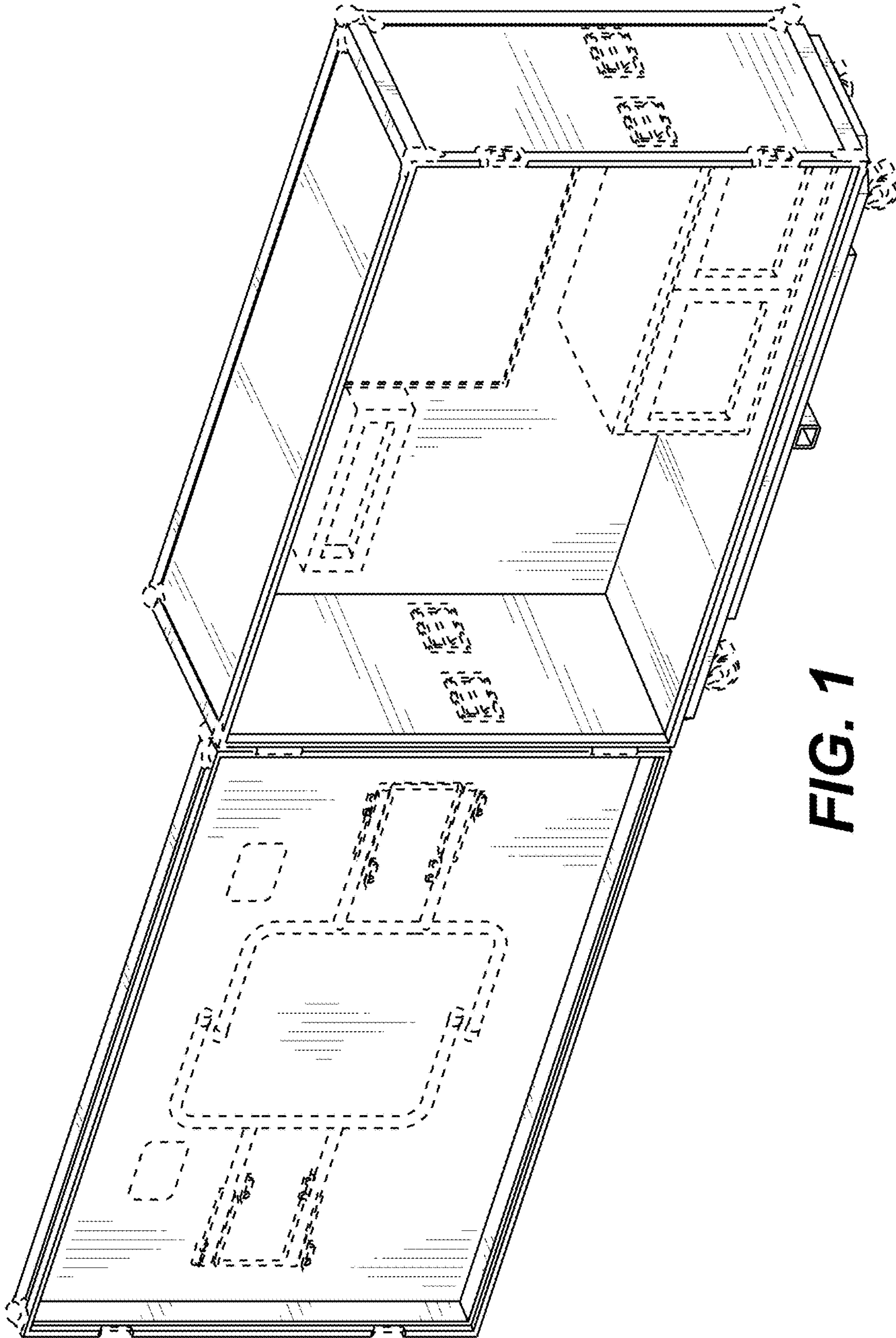

FIG. 1

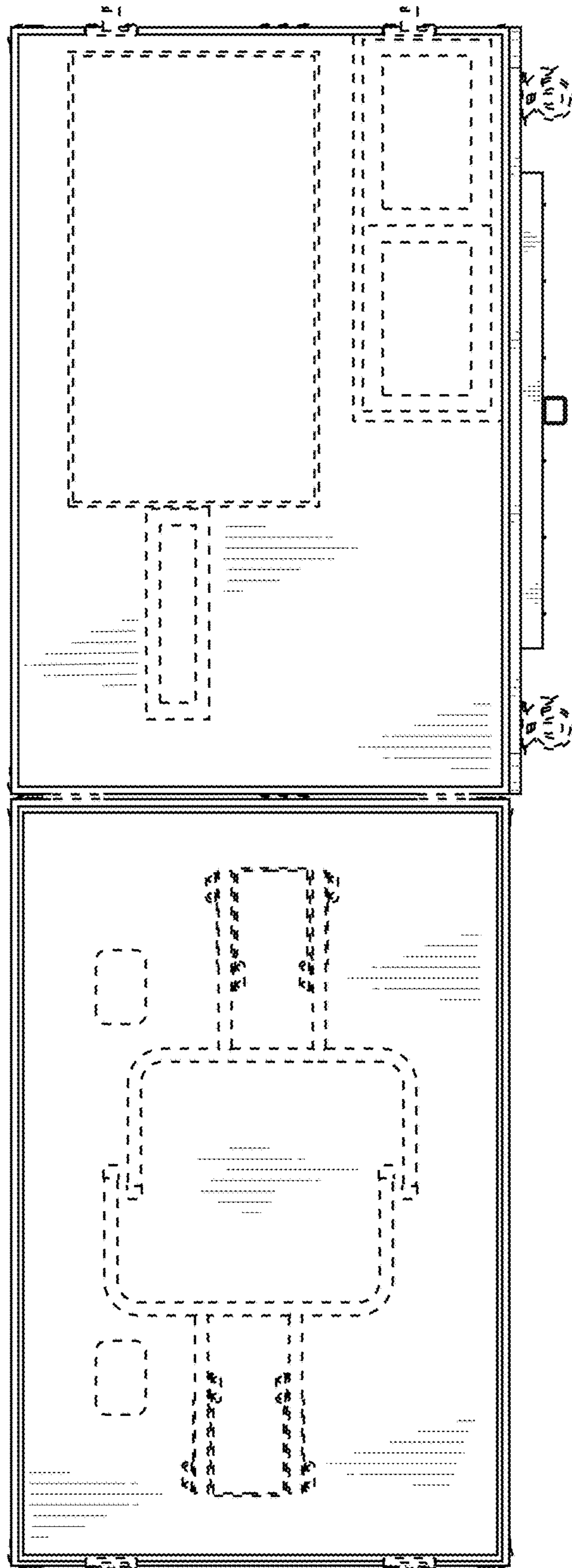

FIG. 2

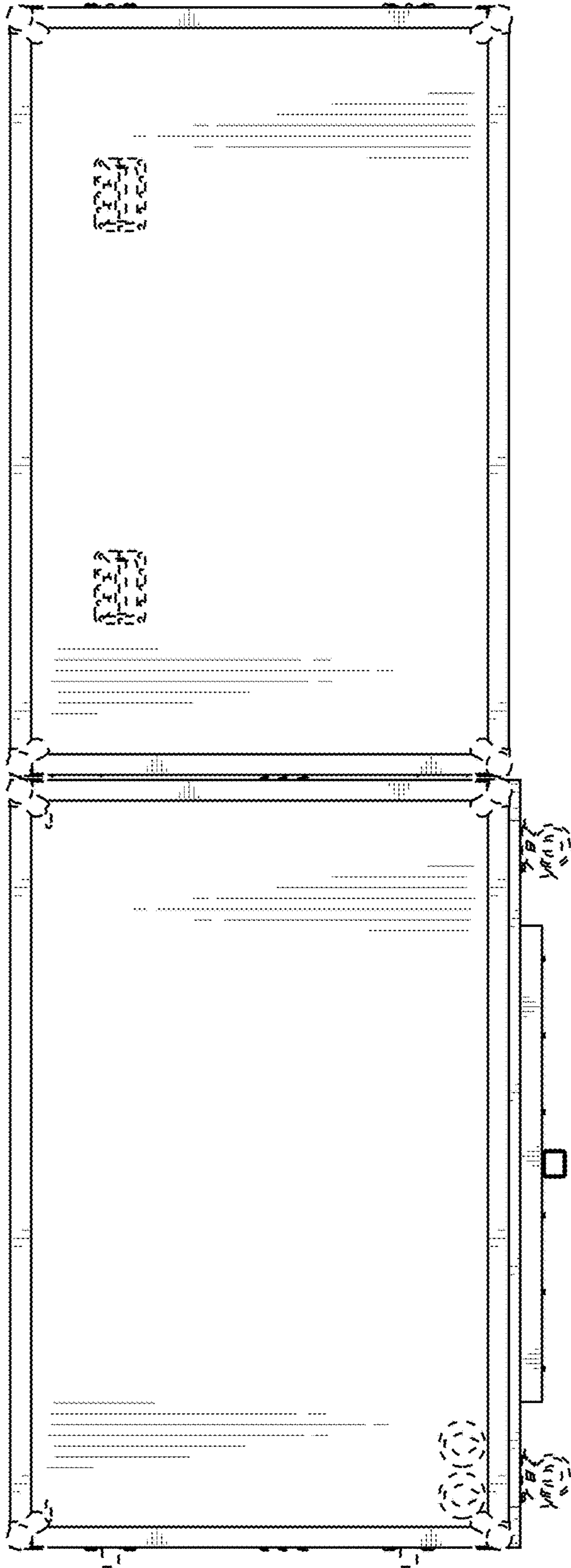

FIG. 3

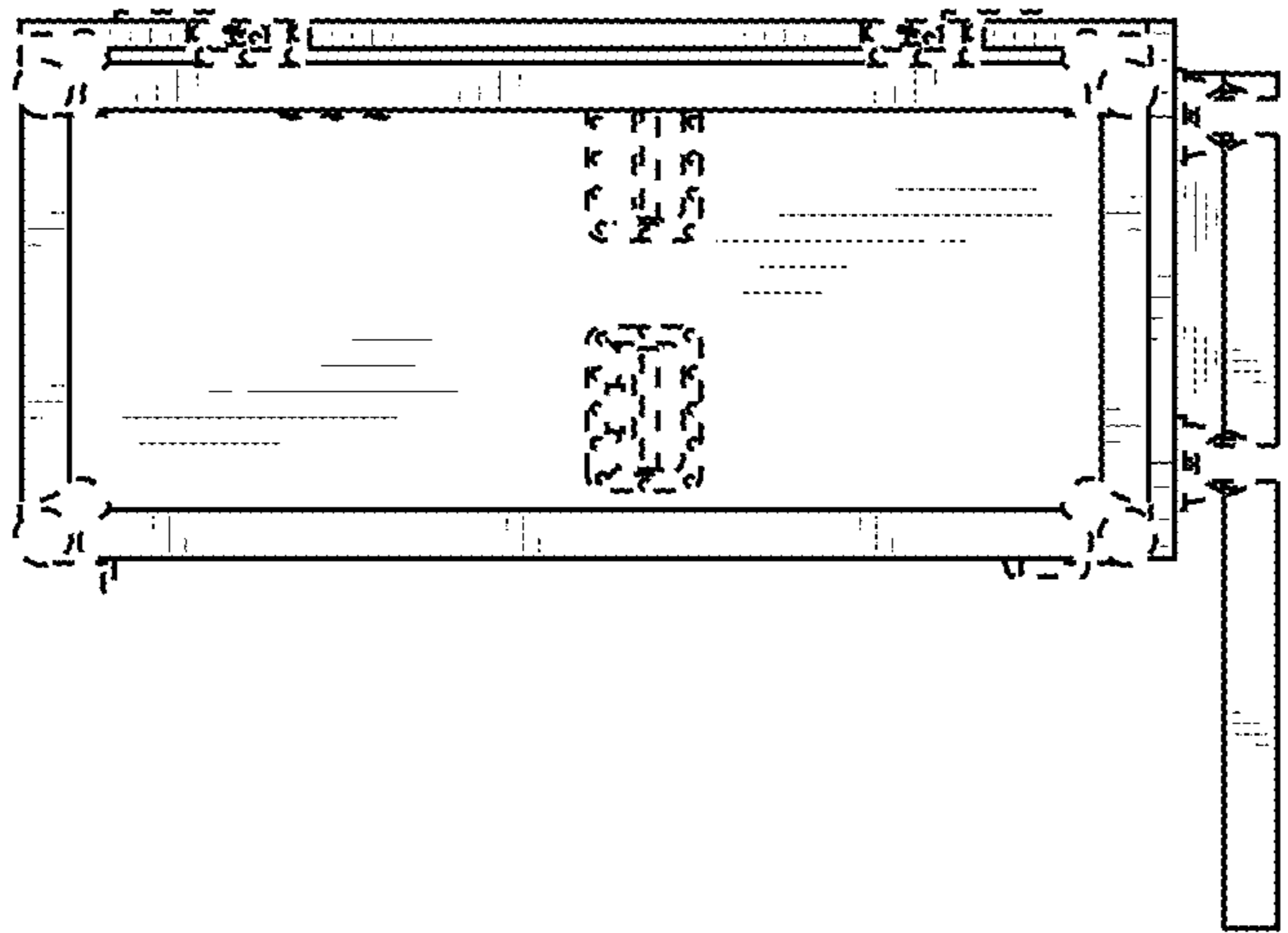

FIG. 4

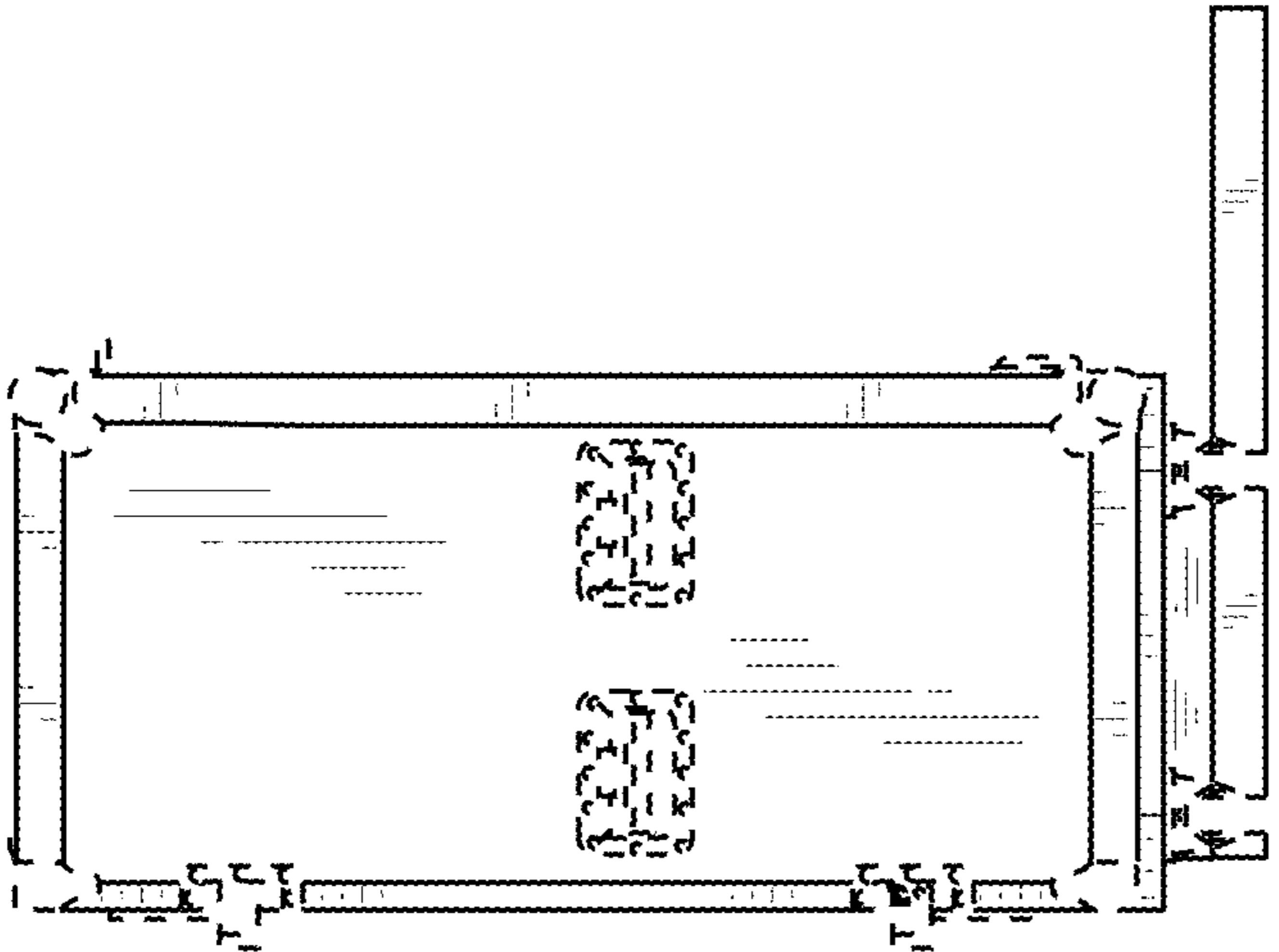

FIG. 5

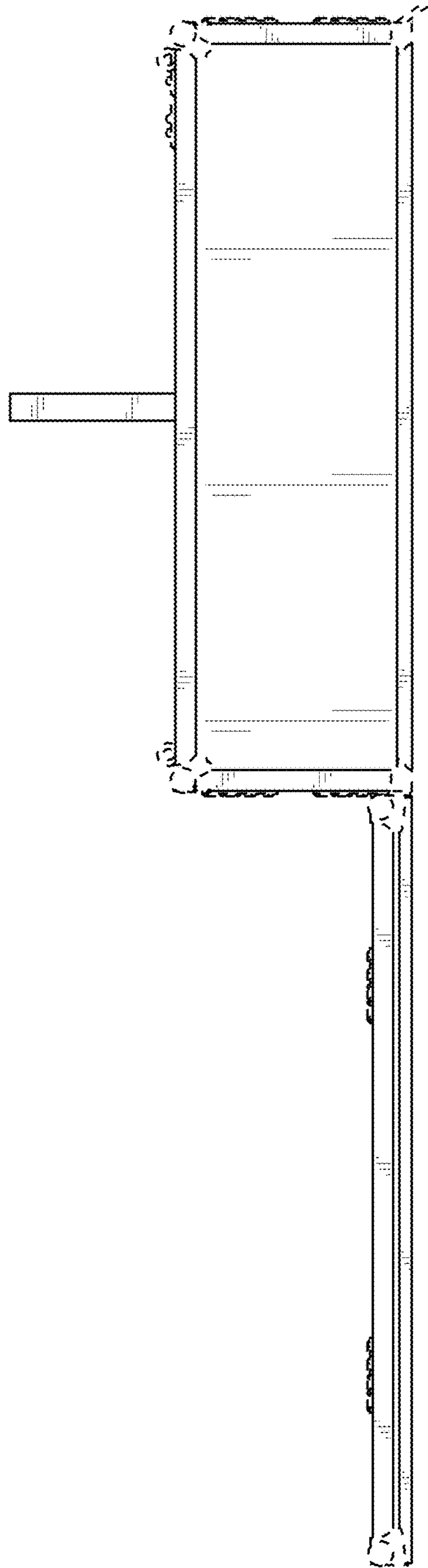

FIG. 6

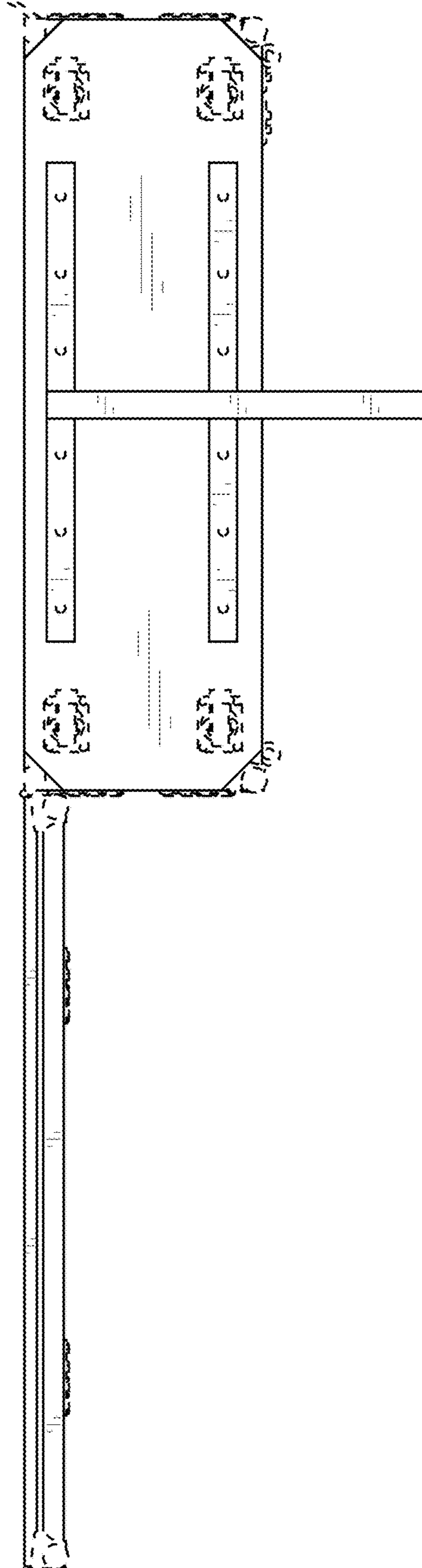

FIG. 7