



US00D815566S

(12) **United States Design Patent** (10) **Patent No.:** **US D815,566 S**  
**Oyanagi et al.** (45) **Date of Patent:** **\*\* Apr. 17, 2018**

(54) **MOTORCYCLE**  
(71) Applicant: **KAWASAKI JUKOGYO KABUSHIKI KAISHA**, Kobe-shi, Hyogo (JP)  
(72) Inventors: **Juichi Oyanagi**, Kobe (JP); **Kaoru Kouchi**, Kakogawa (JP); **Takumi Uemoto**, Kobe (JP)  
(73) Assignee: **KAWASAKI JUKOGYO KABUSHIKI KAISHA**, Kobe-Shi, Hyogo (JP)

D581,839 S \* 12/2008 Sasanami ..... D12/110  
D582,316 S \* 12/2008 Stenegard ..... D12/110  
D582,320 S \* 12/2008 Tanaka ..... D12/110  
D588,961 S \* 3/2009 Tanaka ..... D12/110  
D591,204 S \* 4/2009 Matsuzawa ..... D12/110  
D591,205 S \* 4/2009 Heinrich ..... D12/110  
D594,786 S \* 6/2009 Sakata ..... D12/110  
D596,082 S \* 7/2009 Ueno ..... D12/110  
D597,449 S \* 8/2009 Nagao ..... D12/110  
D601,458 S \* 10/2009 Nagao ..... D12/110  
D605,089 S \* 12/2009 Tanaka ..... D12/110  
D605,090 S \* 12/2009 Tanaka ..... D12/110

(Continued)

**FOREIGN PATENT DOCUMENTS**

JP D1356056 4/2009  
JP D1412674 5/2017

(\*\*) Term: **15 Years**  
(21) Appl. No.: **29/593,563**  
(22) Filed: **Feb. 9, 2017**

**OTHER PUBLICATIONS**

Decision of Registration and Notice Informing the Examination Materials, Issued Dec. 13, 2016 for Corresponding Japan Design Patent Application No. 2016-018946.

*Primary Examiner* — Darlington Ly

(30) **Foreign Application Priority Data**  
Sep. 2, 2016 (JP) ..... 2016-018946  
(51) **LOC (11) Cl.** ..... **12-11**  
(52) **U.S. Cl.**  
USPC ..... **D12/110**  
(58) **Field of Classification Search**  
USPC ..... D12/110, 111, 117; D21/432, 538  
CPC ..... B62K 11/00; B62K 11/02; B62K 11/04;  
B62K 11/10; B62K 17/00; B62K 19/00;  
B62K 2202/00  
See application file for complete search history.

(57) **CLAIM**

The ornamental design for a motorcycle, as shown and described.

**DESCRIPTION**

FIG. 1 is a front elevation view of a motorcycle showing our new design;  
FIG. 2 is a rear elevation view thereof;  
FIG. 3 is a right side elevation view thereof;  
FIG. 4 is a left side elevation view thereof;  
FIG. 5 is a top plan view thereof;  
FIG. 6 is a top, front, and right side perspective view thereof; and,  
FIG. 7 is a top, rear, and left side perspective view thereof.

(56) **References Cited**  
**U.S. PATENT DOCUMENTS**  
D403,277 S \* 12/1998 Kokubu ..... D12/110  
D496,309 S \* 9/2004 Fukumoto ..... D12/110  
D504,844 S \* 5/2005 Sasanami ..... D12/110  
D548,649 S \* 8/2007 Heinrich ..... D12/110  
D549,137 S \* 8/2007 Heinrich ..... D12/110  
D551,129 S \* 9/2007 Takeda ..... D12/110  
D567,717 S \* 4/2008 Hishiki ..... D12/110

**1 Claim, 7 Drawing Sheets**

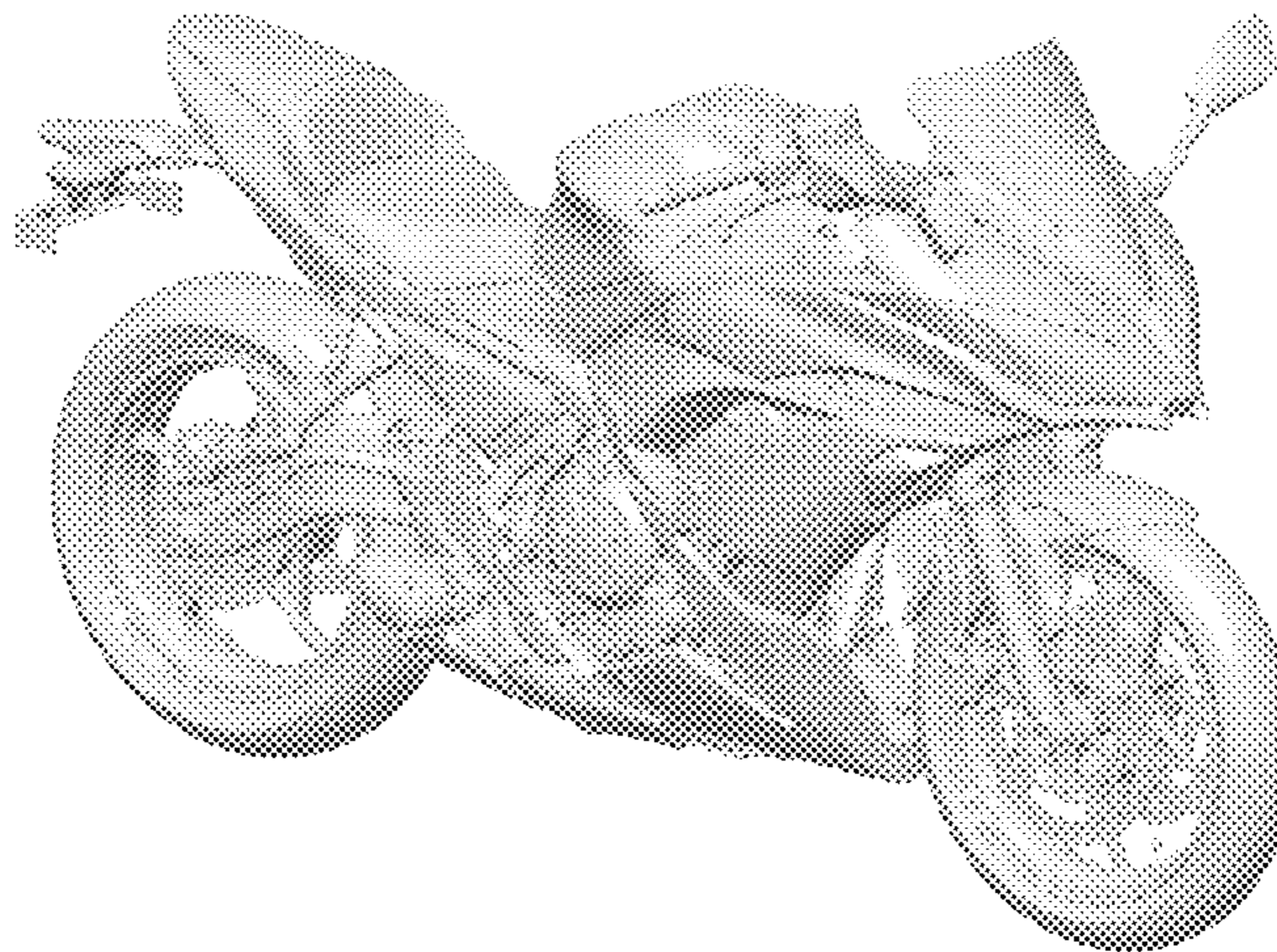

(56)

References Cited

U.S. PATENT DOCUMENTS

D606,457 S \* 12/2009 Tanaka ..... D12/110  
 D611,390 S \* 3/2010 Toriyama ..... D12/110  
 D624,473 S 9/2010 Toshiyuki Nishihara  
 D638,756 S \* 5/2011 Kouchi ..... D12/110  
 D643,341 S \* 8/2011 Uchiyama ..... D12/110  
 D647,824 S \* 11/2011 Kouchi ..... D12/110  
 D647,825 S \* 11/2011 Shibuta ..... D12/110  
 D669,397 S \* 10/2012 Isokari ..... D12/110  
 D669,821 S \* 10/2012 Nishihara ..... D12/110  
 D670,204 S \* 11/2012 Yasuhara ..... D12/110  
 D686,538 S \* 7/2013 Nagao ..... D12/110  
 D688,982 S \* 9/2013 Oyanagi ..... D12/110  
 D688,983 S \* 9/2013 Shibuta ..... D12/110  
 D689,406 S \* 9/2013 Yasuhara ..... D12/110  
 D694,673 S \* 12/2013 Katagiri ..... D12/110  
 8,807,259 B2 \* 8/2014 Tominaga ..... B62K 11/04  
 180/219  
 8,827,024 B1 \* 9/2014 Sumi ..... B62K 25/02  
 180/227

D718,669 S \* 12/2014 Kiska ..... D12/110  
 D723,431 S \* 3/2015 Noguchi ..... D12/110  
 D735,085 S \* 7/2015 Buckan ..... D12/110  
 D736,677 S \* 8/2015 Imura ..... D12/110  
 D755,084 S \* 5/2016 Sakata ..... D12/110  
 D755,680 S \* 5/2016 Yashuhara ..... D12/110  
 D755,681 S \* 5/2016 Martin ..... D12/110  
 D755,682 S \* 5/2016 Hahn-Woernle ..... D12/110  
 D756,268 S \* 5/2016 Yamada ..... D12/110  
 D758,923 S \* 6/2016 Yamada ..... D12/110  
 D758,924 S \* 6/2016 Tamura ..... D12/110  
 D795,746 S \* 8/2017 Akita ..... D12/110  
 D797,002 S \* 9/2017 Toyama ..... D12/110  
 D801,230 S \* 10/2017 Endo ..... D12/110  
 2012/0318598 A1 \* 12/2012 Fujiyama ..... B60K 5/12  
 180/219  
 2014/0084565 A1 \* 3/2014 Nakamura ..... B62K 25/283  
 280/284  
 2015/0101875 A1 \* 4/2015 Inayama ..... B60K 13/02  
 180/225

\* cited by examiner



Fig. 1

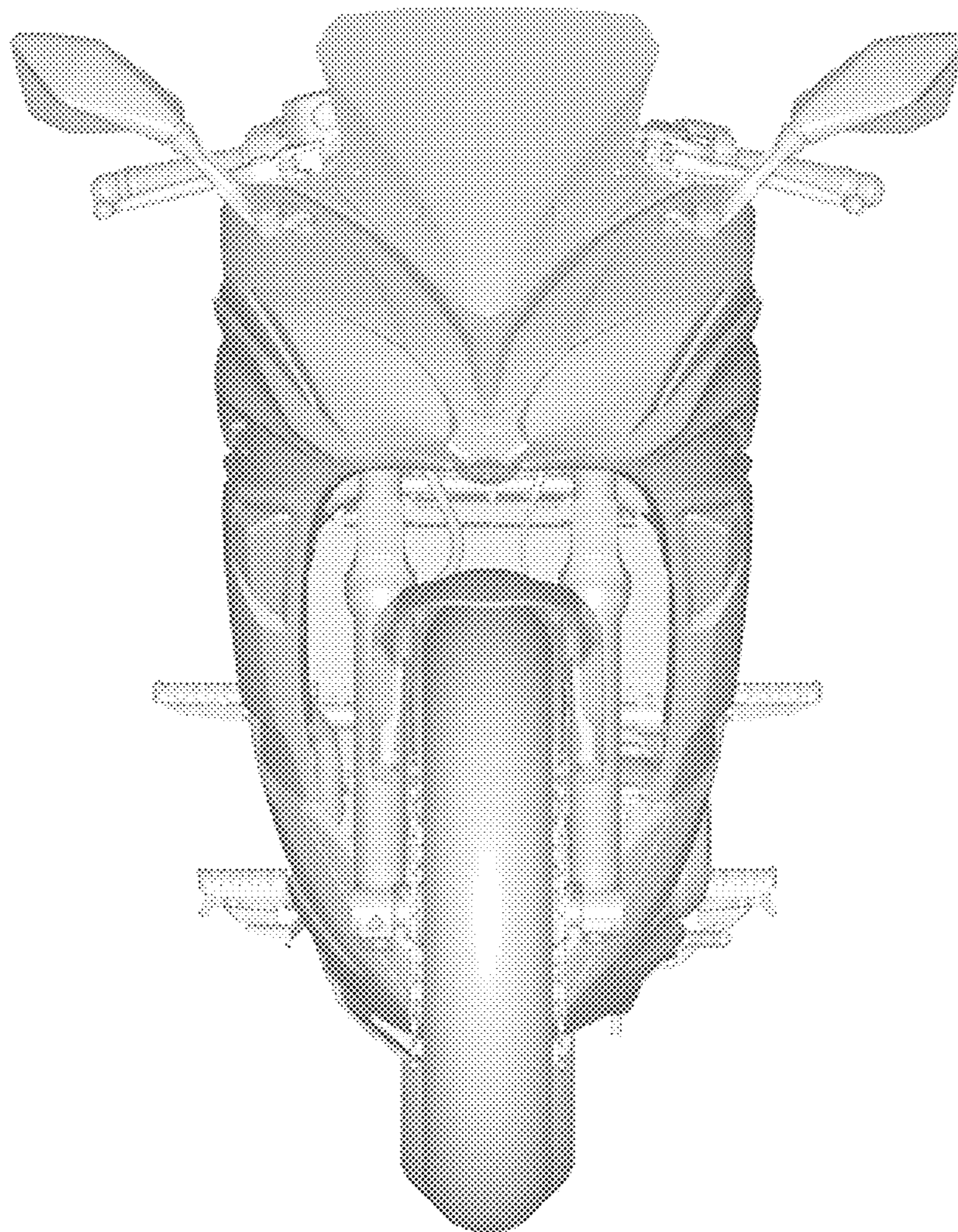
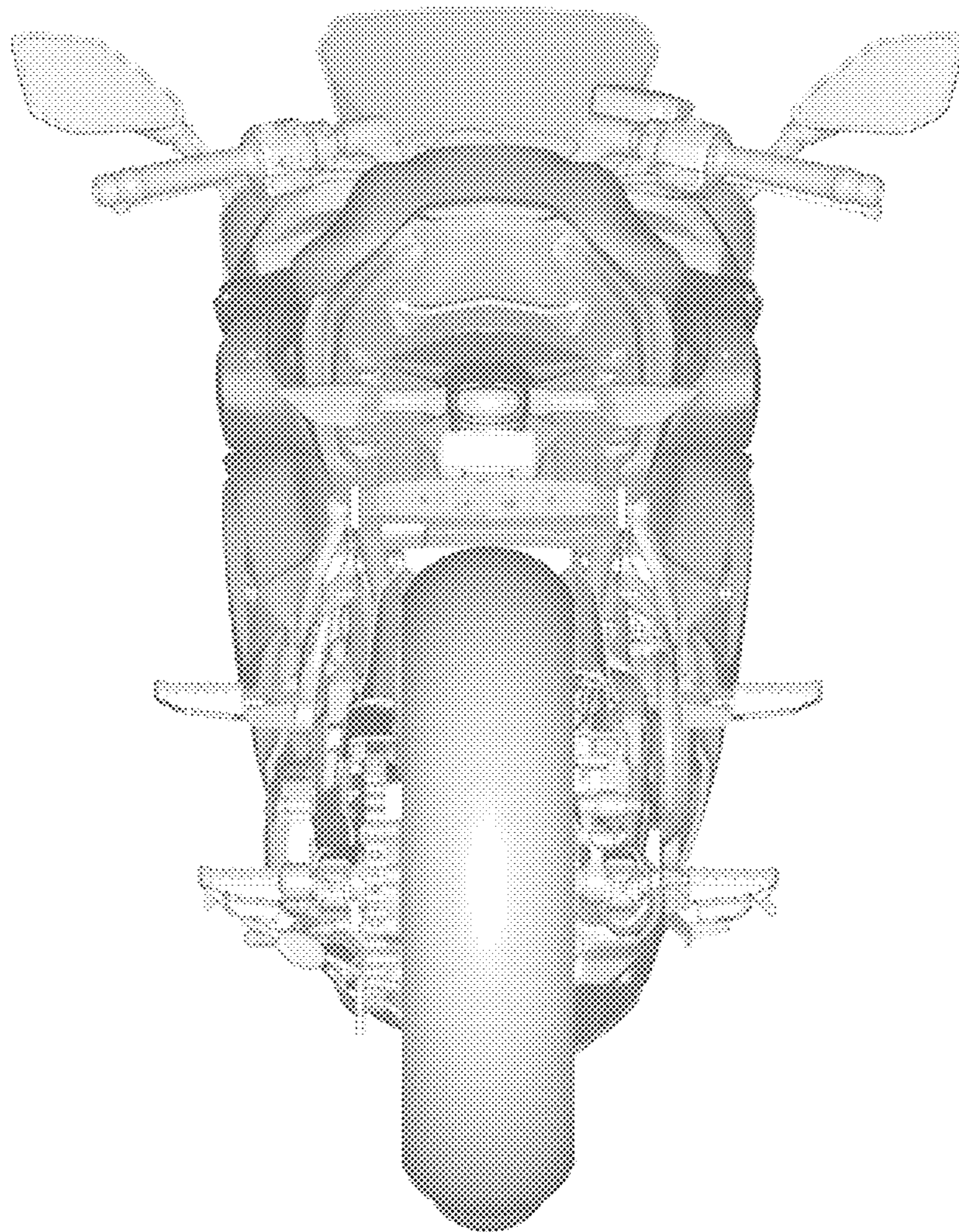

Fig. 2





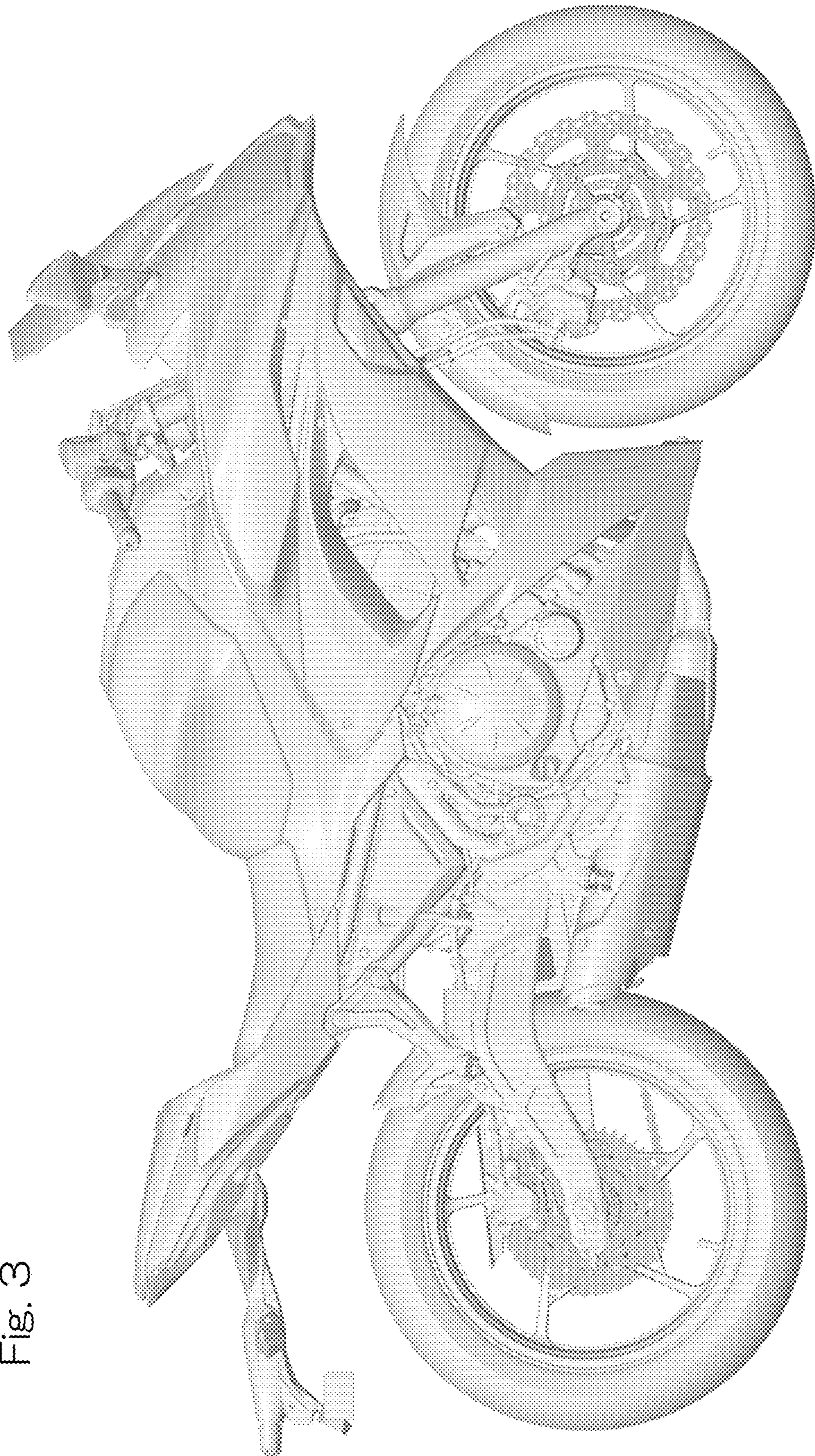

Fig. 3



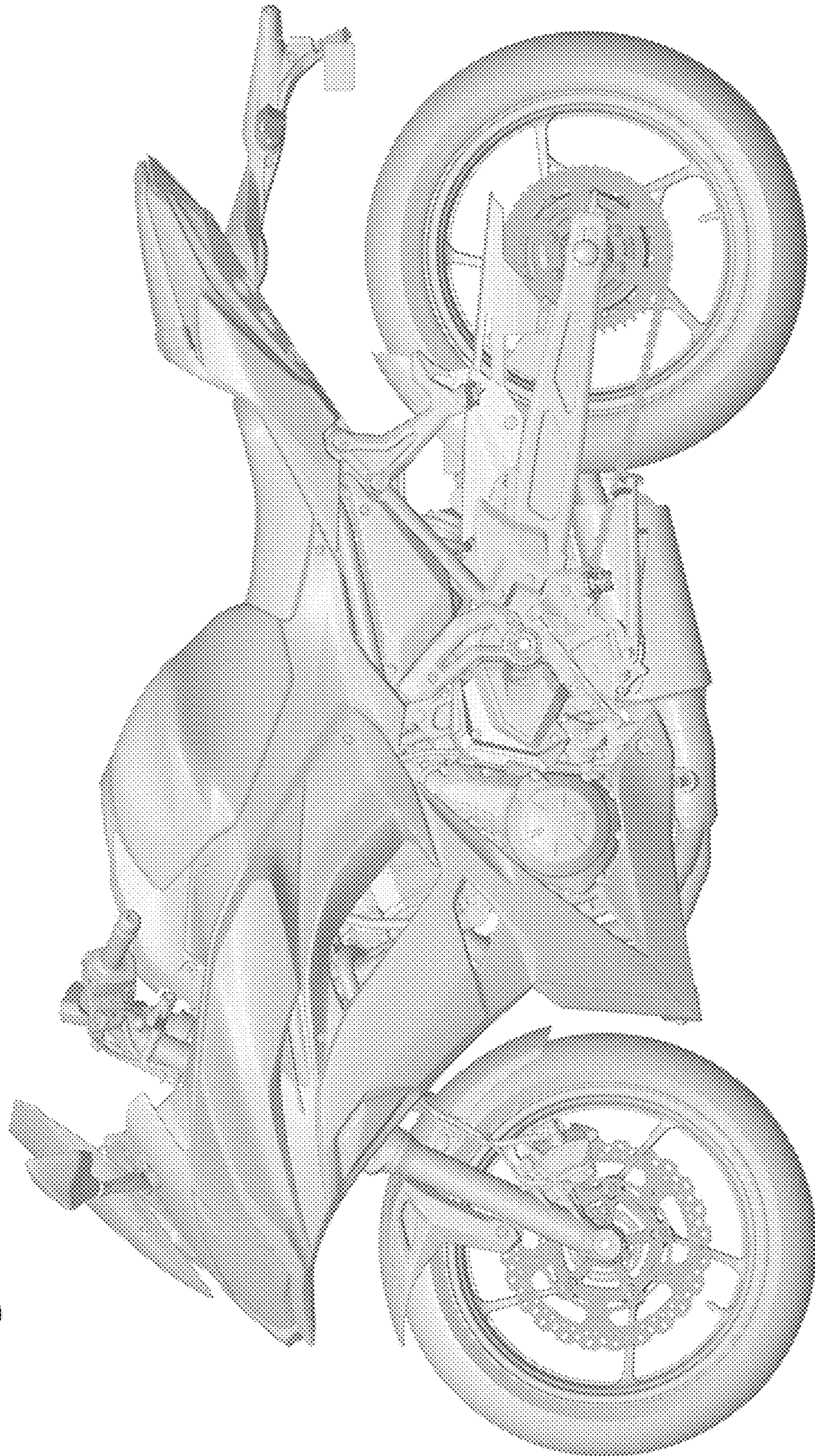
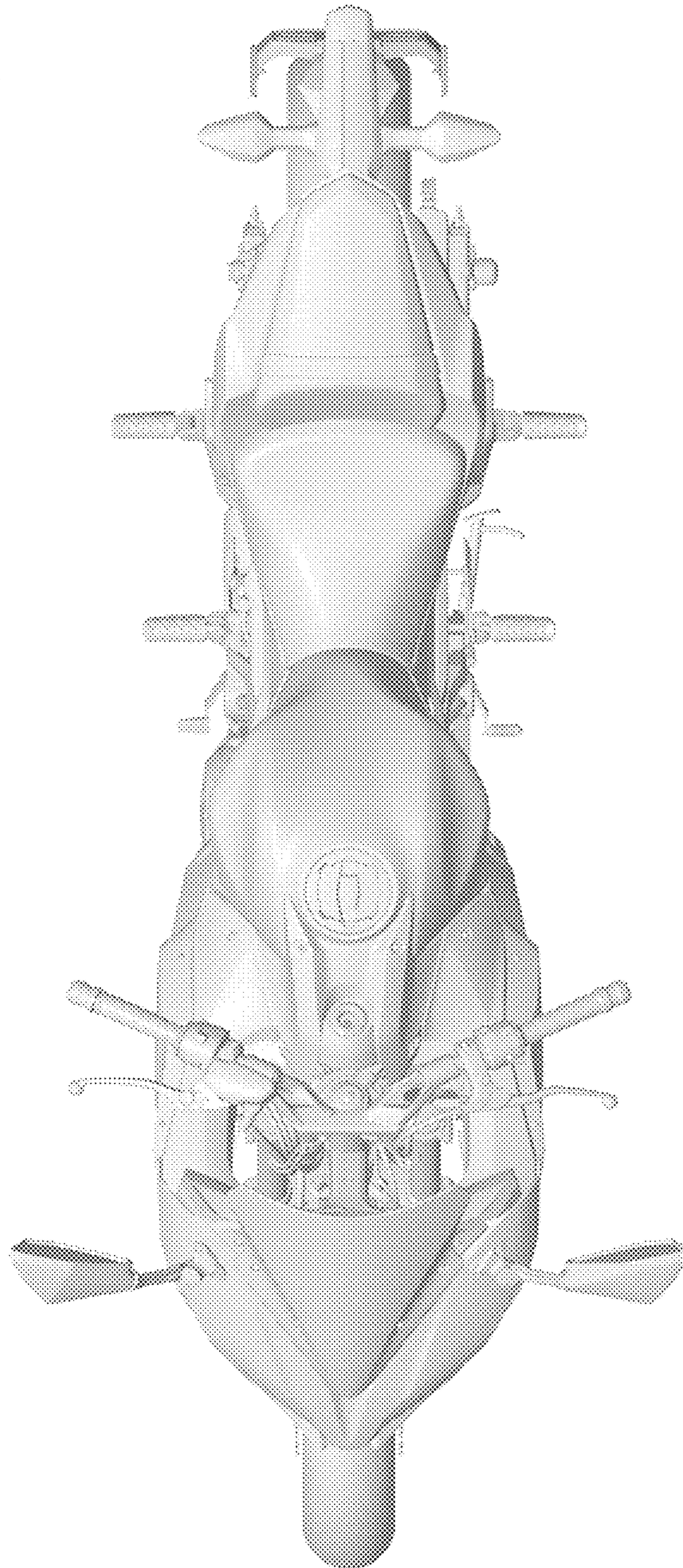

Fig. 4



Fig. 5





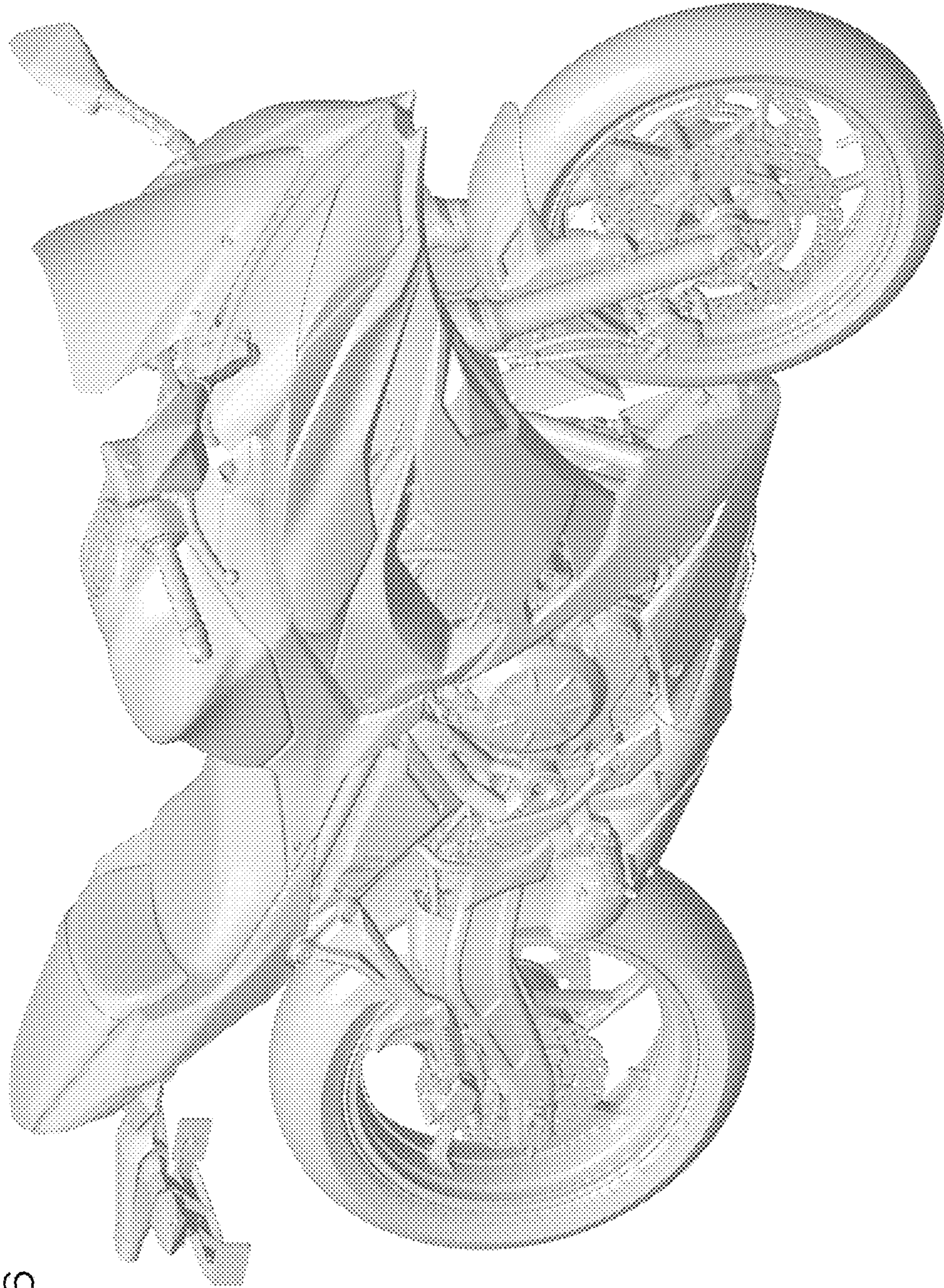

Fig. 6



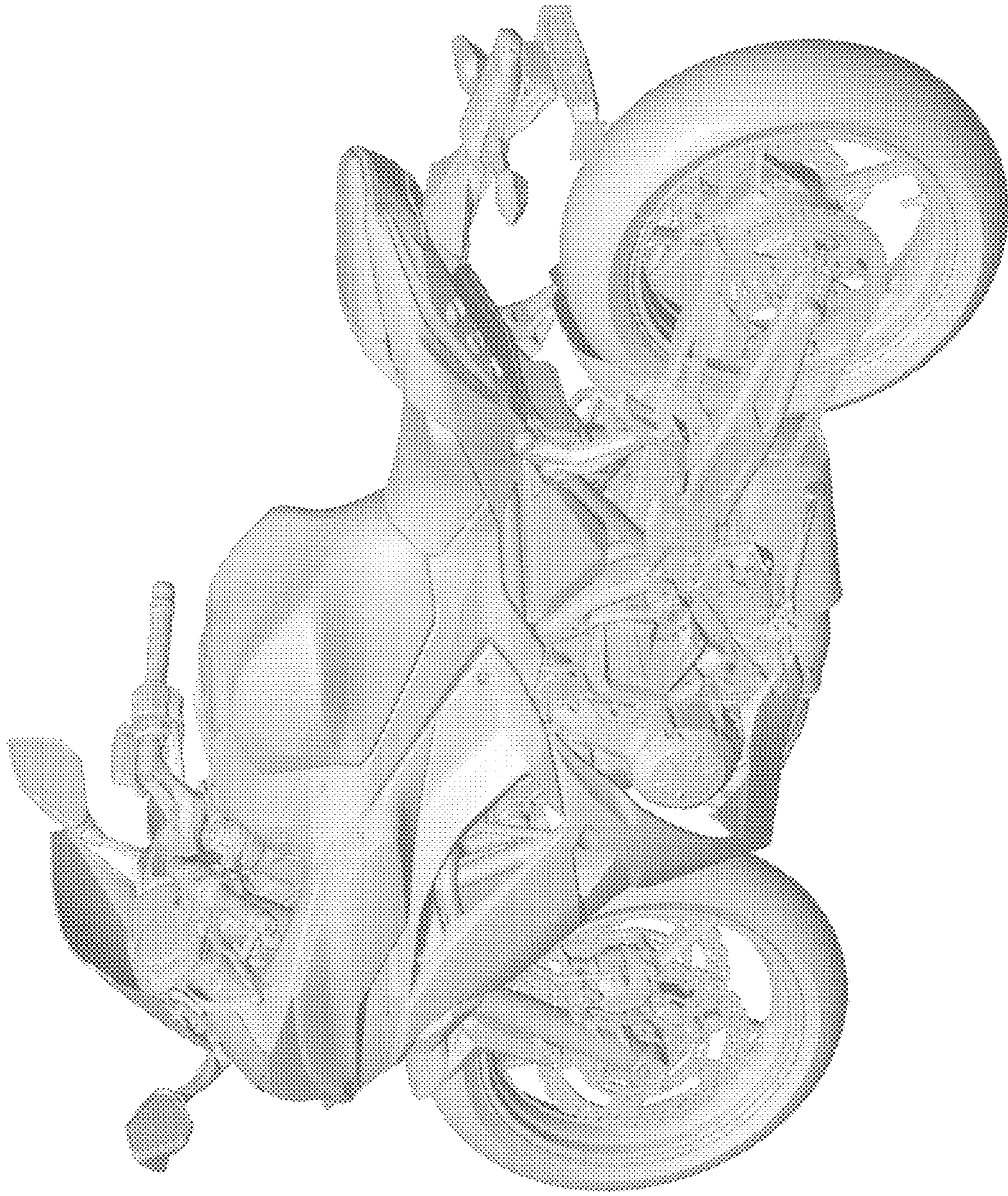

Fig. 7