



US00D815547S

(12) **United States Design Patent**
Plange

(10) **Patent No.:** **US D815,547 S**

(45) **Date of Patent:** **** Apr. 17, 2018**

(54) **WATCH**

(56) **References Cited**

(71) Applicant: **RICHEMONT INTERNATIONAL SA, Villars-sur-Glâne (CH)**

U.S. PATENT DOCUMENTS

(72) Inventor: **Gerd Thomas Rudolf Plange, Beringen (CH)**

D732,985 S *	6/2015	Cerrato	D10/39
D762,490 S *	8/2016	Tonohori	D10/126
D789,808 S *	6/2017	Kimura	D10/30
D793,879 S *	8/2017	Tonohori	D10/30
D795,087 S *	8/2017	Monachon	D10/30
D800,578 S *	10/2017	Behling	D10/30
D801,832 S *	11/2017	White	D10/30

(**) Term: **15 Years**

* cited by examiner

(21) Appl. No.: **35/501,974**

(22) Filed: **May 27, 2016**

Primary Examiner — George D Kirschbaum

(80) **Hague Agreement Data**

Int. Filing Date: **May 27, 2016**
Int. Reg. No.: **DM/090927**
Int. Reg. Date: **May 27, 2016**
Int. Reg. Pub. Date: **Dec. 2, 2016**

(57) **CLAIM**

The ornamental design for a watch, as shown and described.

(30) **Foreign Application Priority Data**

Nov. 30, 2015 (WO) DM/088562

(51) **LOC (11) Cl.** **10-02**

(52) **U.S. Cl.**
USPC **D10/30**

(58) **Field of Classification Search**
USPC D10/30, 32, 38, 39, 126
CPC G04B 19/00
See application file for complete search history.

DESCRIPTION

- 1. Watch
- 1.1 : Front
- 1.2 : Back
- 1.3 : Top
- 1.4 : Bottom
- 1.5 : Left
- 1.6 : Right
- 1.7 : Perspective
- 1.8 : Perspective

1 Claim, 8 Drawing Sheets

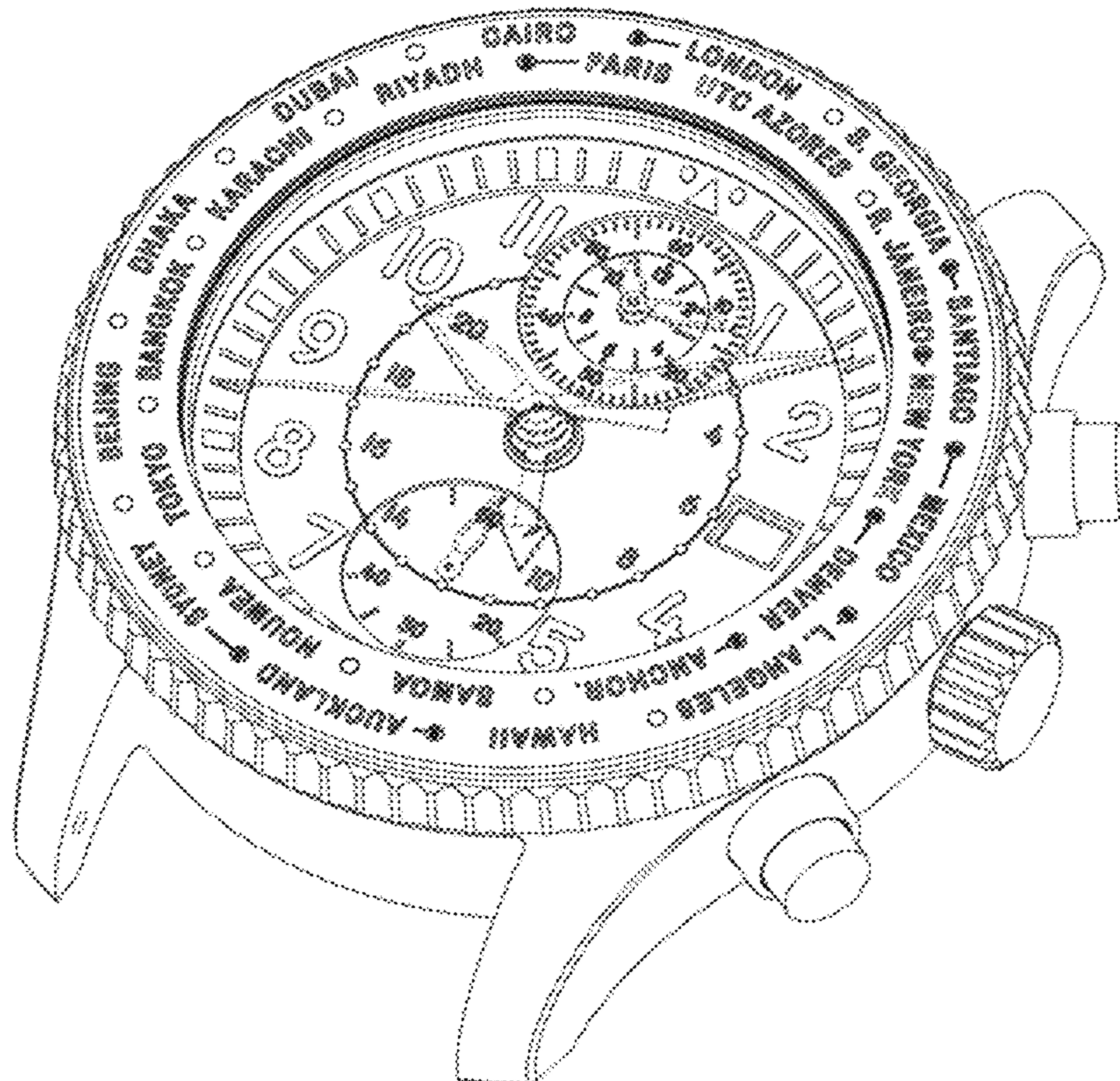

1.1



1.2

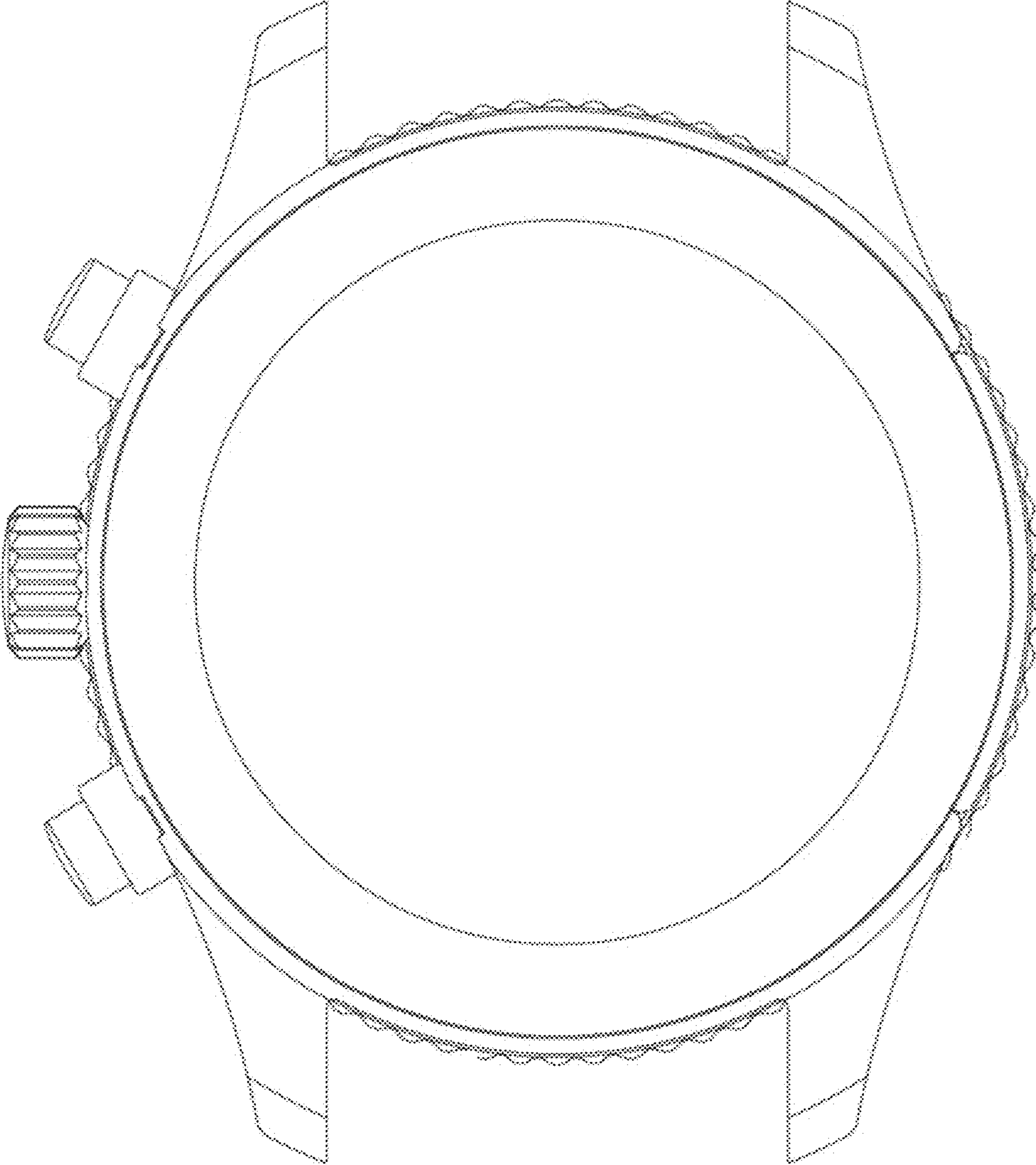

1.3

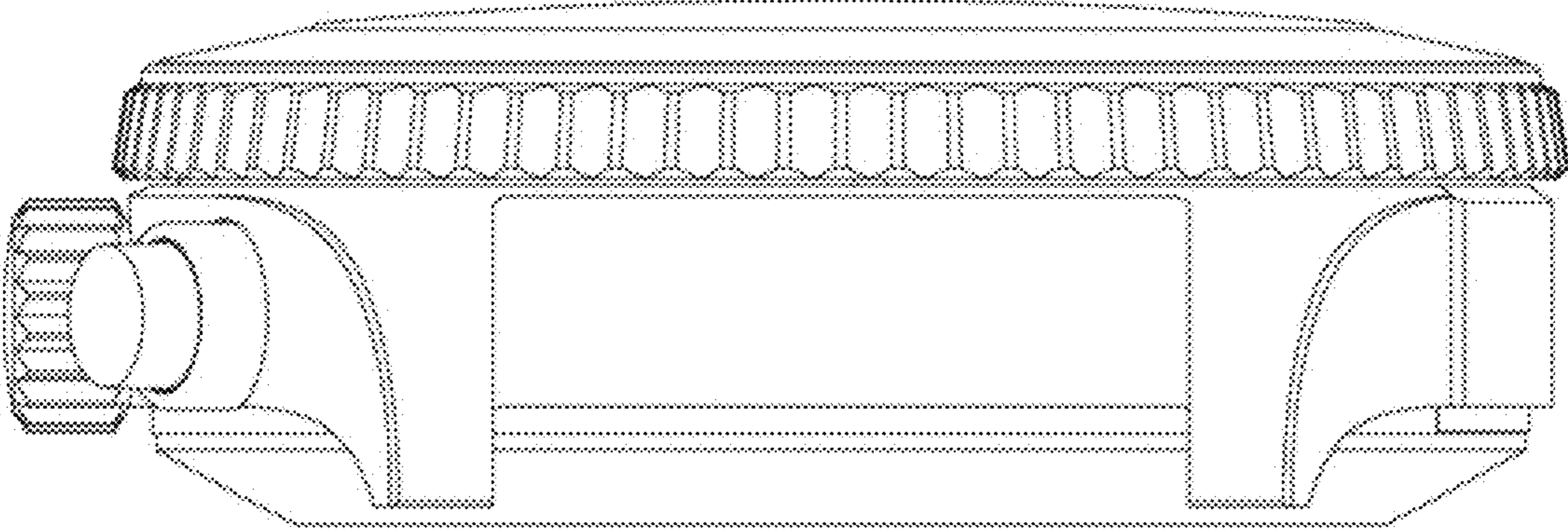

1.4

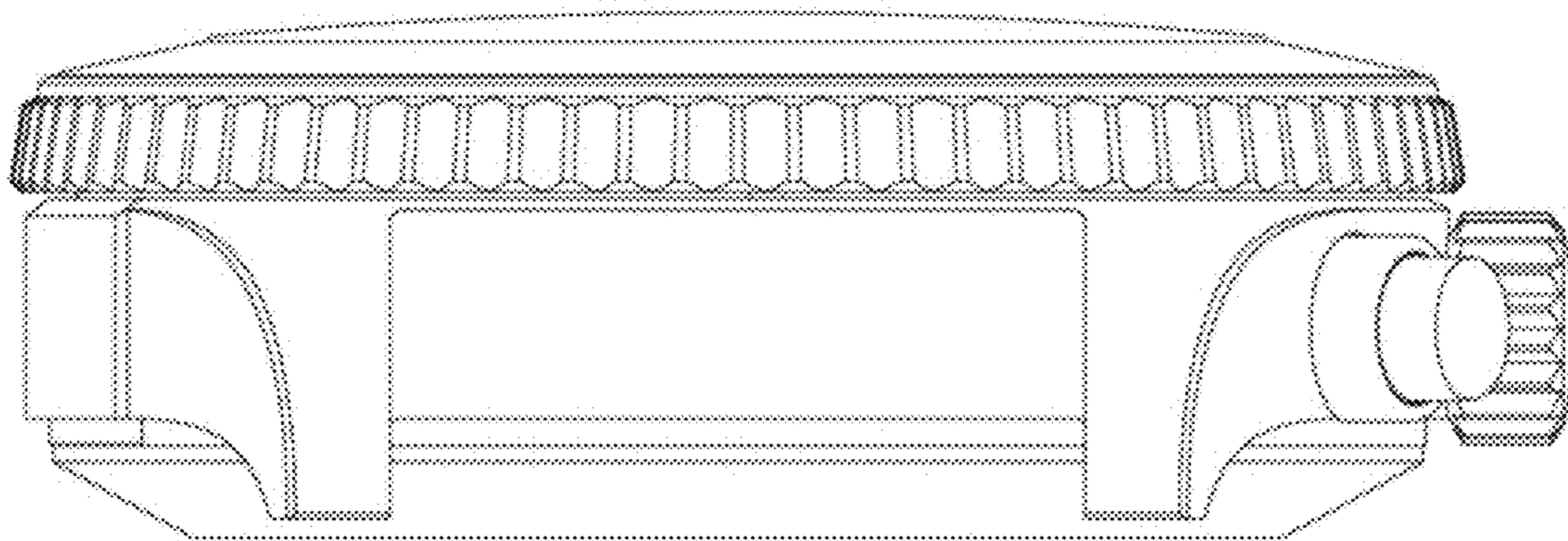

1.5

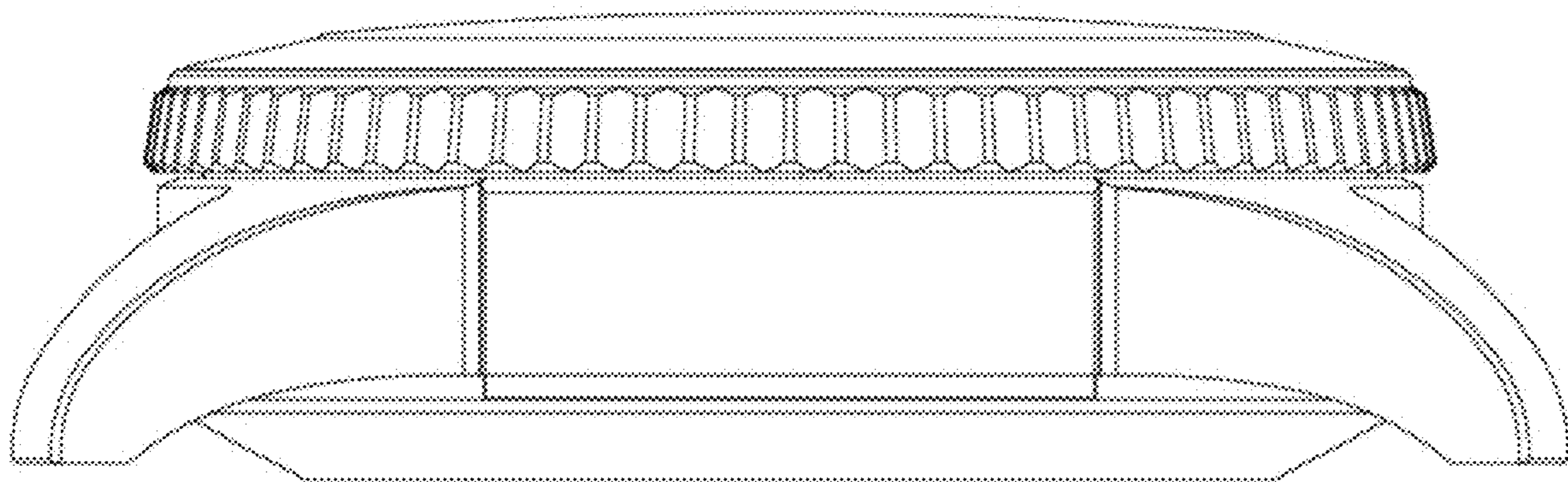

1.6

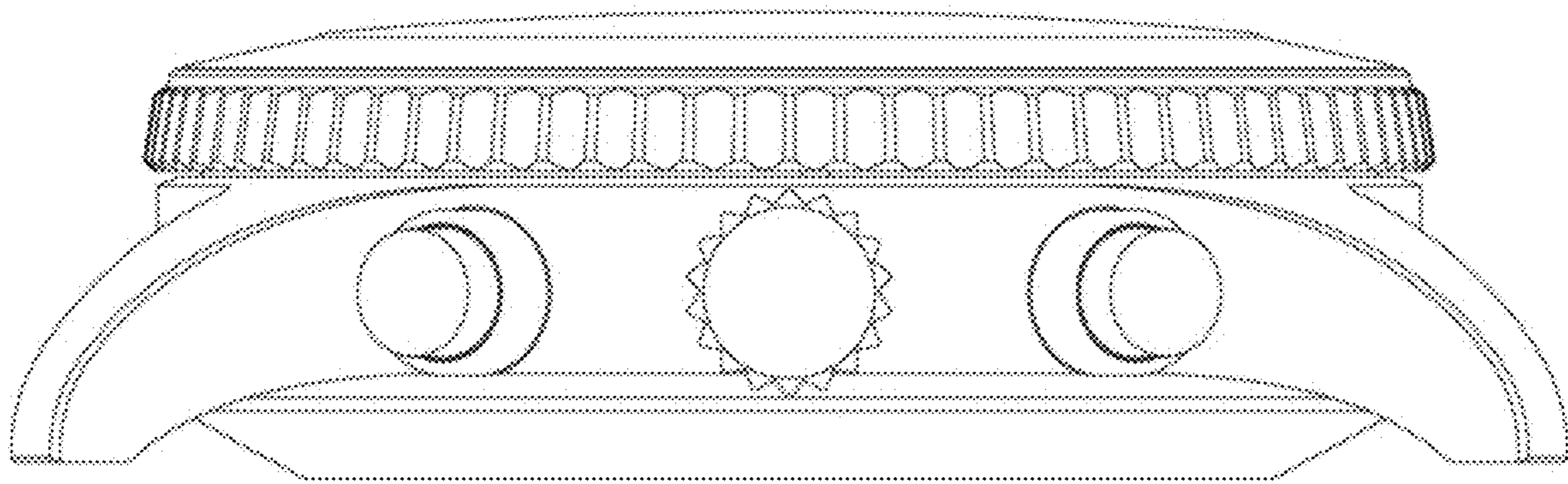

1.7

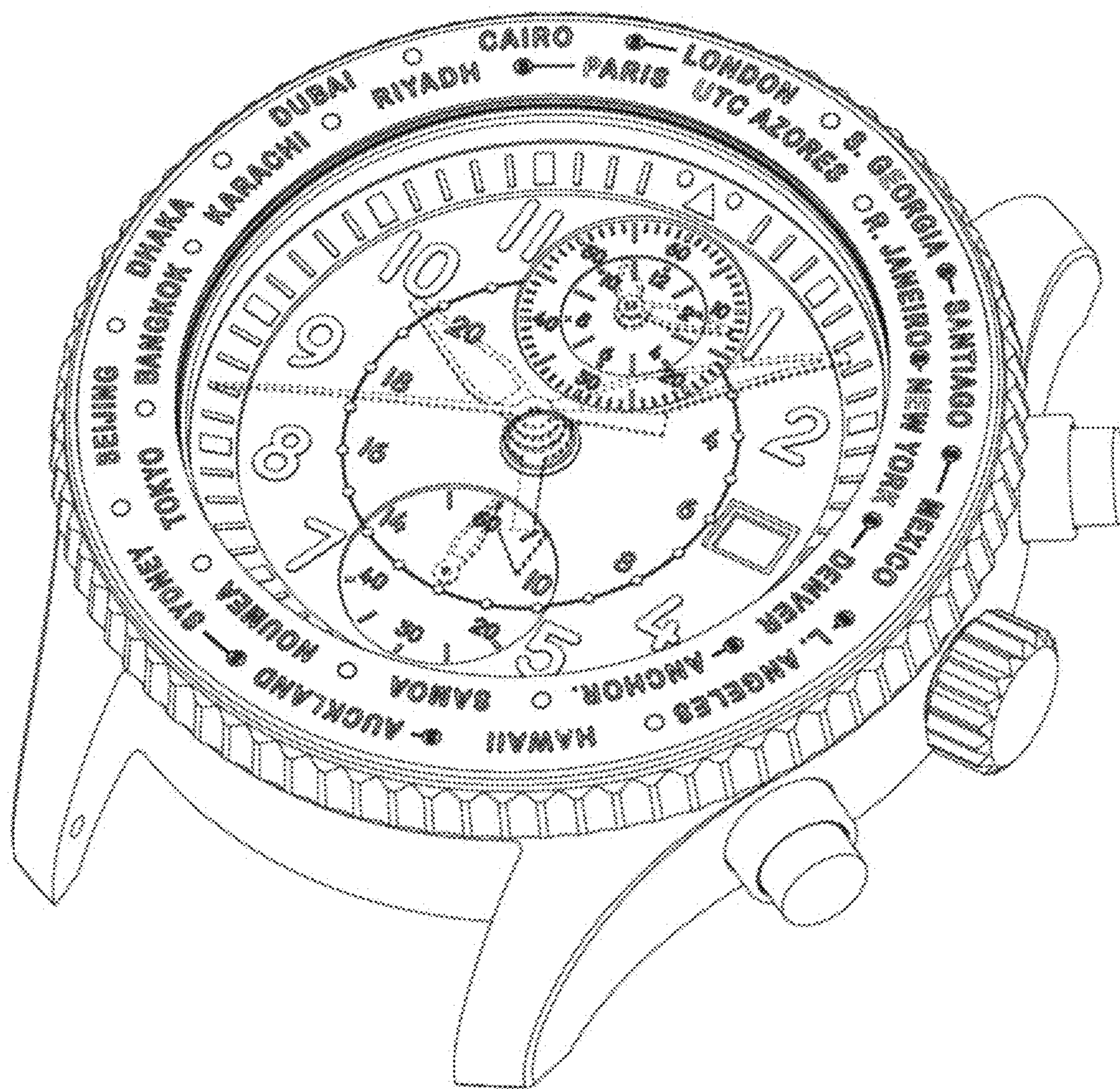

1.8

