



US00D815522S

(12) **United States Design Patent**  
**Vegliante**

(10) **Patent No.:** **US D815,522 S**

(45) **Date of Patent:** **\*\* Apr. 17, 2018**

(54) **PLASTIC WRAP CONTAINER**

(71) Applicant: **Paul Vegliante**, Franklin Lakes, NJ  
(US)

(72) Inventor: **Paul Vegliante**, Franklin Lakes, NJ  
(US)

(\*\*) Term: **15 Years**

(21) Appl. No.: **29/585,274**

(22) Filed: **Nov. 22, 2016**

(51) **LOC (11) Cl.** ..... **09-03**

(52) **U.S. Cl.**  
USPC ..... **D9/432; D9/414**

(58) **Field of Classification Search**  
USPC ..... D9/414-419, 420-423, 430-434, 457,  
D9/711, 713, 720-722, 733, 734, 737,  
D9/761; D3/290, 304, 305, 315  
CPC ..... B65D 5/00; B65D 5/0015; B65D 5/061;  
B65D 5/18; B65D 5/20; B65D 5/32;  
B65D 5/321; B65D 5/322  
See application file for complete search history.

(56) **References Cited**

**U.S. PATENT DOCUMENTS**

D255,779 S *	7/1980	Clatterbuck	.....	D9/734
D293,211 S *	12/1987	DePaul	.....	D9/416
D447,685 S *	9/2001	Chagnon	.....	D9/416
D504,314 S *	4/2005	Kim	.....	D9/416
D540,187 S *	4/2007	Duffy	.....	D9/734
7,406,904 B2 *	8/2008	Antal	.....	B26D 1/045 225/42

(Continued)

**OTHER PUBLICATIONS**

Plastic Wrap Dispenser Saran Wrap Cutter. [online] Published on Oct. 14, 2014. Retrieved Oct. 16, 2017 from URL: <https://wowbeli.com/plastic-wrap-dispenser-saran-wrap-cutter-poly-bags-cling-film-food-storage-containers-kitchen-accessories-supplies-products/>.\*

(Continued)

*Primary Examiner* — Vy N Koenig

(74) *Attorney, Agent, or Firm* — McCarter & English, LLP

(57) **CLAIM**

The ornamental design for a plastic wrap container, as shown and described.

**DESCRIPTION**

FIG. 1 is a perspective view of a plastic wrap container showing my new design;

FIG. 2 is a front view of the plastic wrap container of FIG. 1;

FIG. 3 is a rear view of the plastic wrap container of FIG. 1;

FIG. 4 is a right side view of the plastic wrap container of FIG. 1;

FIG. 5 is a left side view of the plastic wrap container of FIG. 1;

FIG. 6 is a top view of the plastic wrap container of FIG. 1;

FIG. 7 is a bottom view of the plastic wrap container of FIG. 1;

FIG. 8 is a perspective view of another plastic wrap container showing my new design;

FIG. 9 is a front view of the plastic wrap container of FIG. 8;

FIG. 10 is a rear view of the plastic wrap container of FIG. 8;

FIG. 11 is a right side view of the plastic wrap container of FIG. 8;

FIG. 12 is a left side view of the plastic wrap container of FIG. 8;

FIG. 13 is a top view of the plastic wrap container of FIG. 8; and,

FIG. 14 is a bottom view of the plastic wrap container of FIG. 8.

The broken lines shown in the drawings are included for the purpose of illustrating environment and form no part of the claimed design.

**1 Claim, 8 Drawing Sheets**

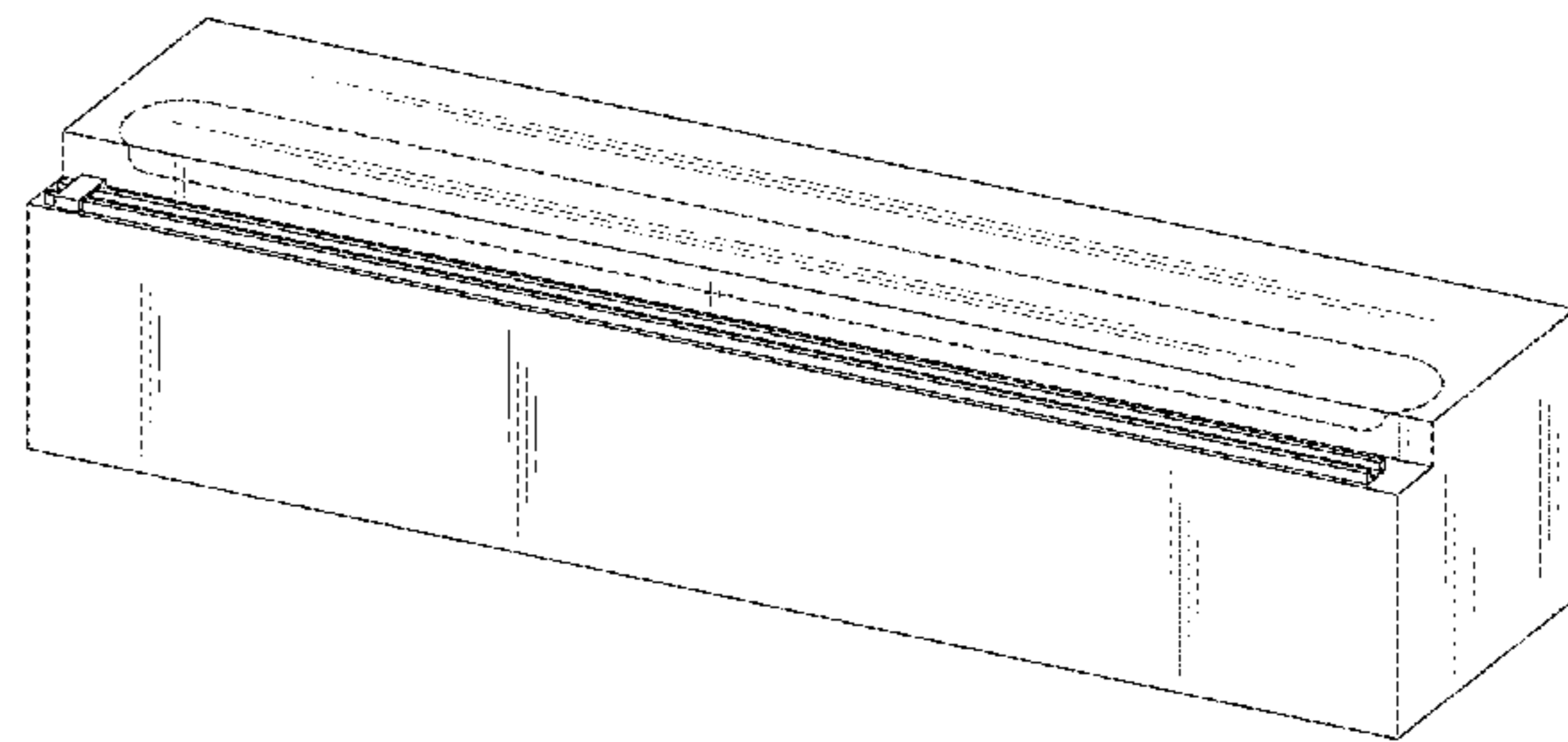
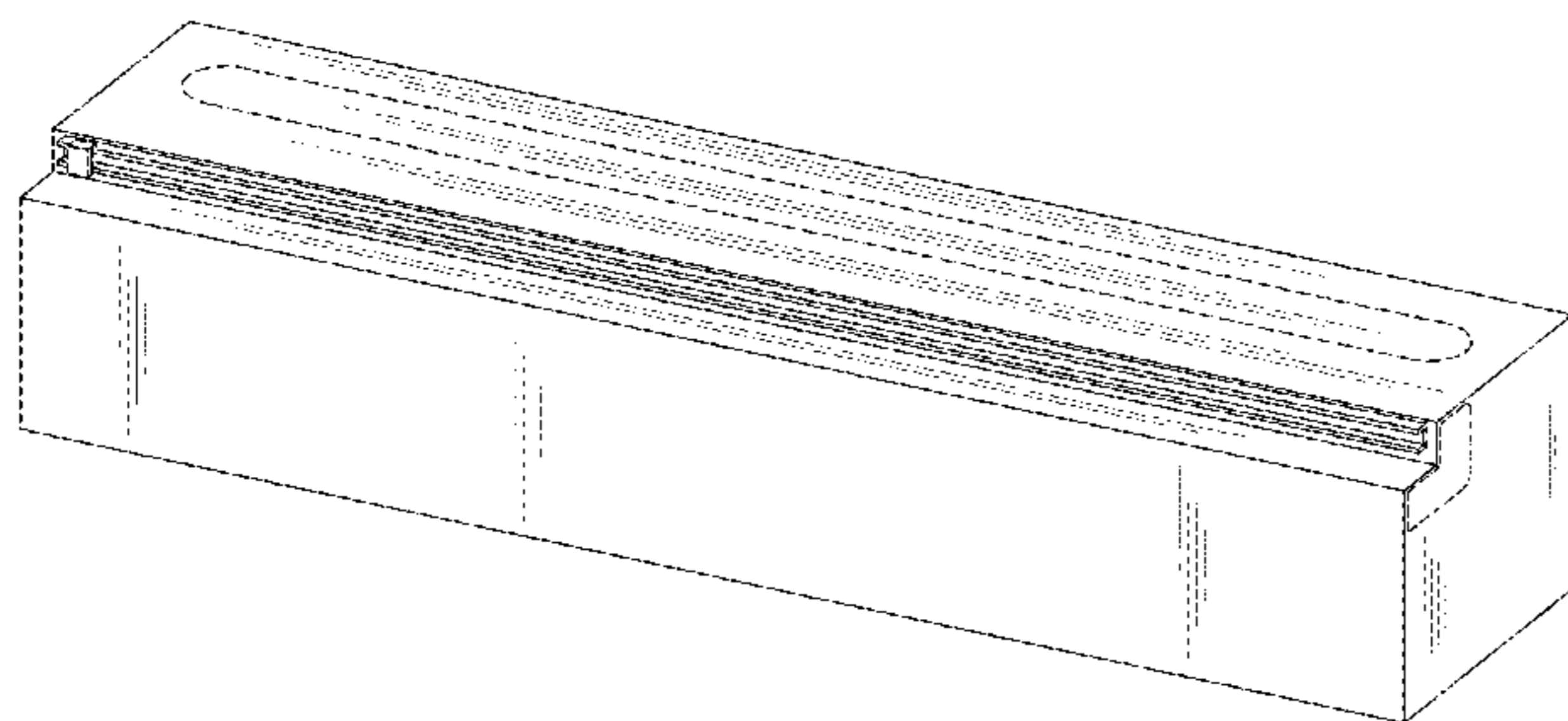

(56)

**References Cited**

## U.S. PATENT DOCUMENTS

7,603,937 B2 \* 10/2009 Pavlik ..... B26D 1/045  
83/614  
D643,747 S \* 8/2011 Rye ..... D9/418  
D700,837 S \* 3/2014 Antal, Sr. .... D9/419  
D778,149 S \* 2/2017 Frick ..... D9/416  
9,604,382 B2 \* 3/2017 Vegliante ..... B26D 7/14  
D787,324 S \* 5/2017 Sotka ..... D9/433  
D787,931 S \* 5/2017 Beck ..... D9/432  
2003/0127352 A1 \* 7/2003 Buschkiel ..... B65D 75/5838  
206/494  
2003/0140760 A1 \* 7/2003 Bory ..... B65H 35/002  
83/614  
2005/0005755 A1 \* 1/2005 Turvey ..... B26D 1/04  
83/614  
2008/0142379 A1 \* 6/2008 Gnatenko ..... A45C 11/00  
206/38  
2016/0051330 A1 \* 2/2016 Cosentino, II ..... A61B 50/20  
221/45

## OTHER PUBLICATIONS

Plastic Wrap Dispenser by ChicWrap. [online] Retrieved Oct. 16, 2017 from URL: [https://www.everythingkitchens.com/chicwrap-plastic-wrap-dispenser-modern-silver-dots-9914.html?utm\\_source=google&utm\\_medium=cse&utm\\_term=9914&gclid=EAlalQobChM10\\_O9wZf11g1Vil6GCh1OXQCdEAQY-CCABEgK\\_zPD\\_BwE.\\*](https://www.everythingkitchens.com/chicwrap-plastic-wrap-dispenser-modern-silver-dots-9914.html?utm_source=google&utm_medium=cse&utm_term=9914&gclid=EAlalQobChM10_O9wZf11g1Vil6GCh1OXQCdEAQY-CCABEgK_zPD_BwE.*)

\* cited by examiner

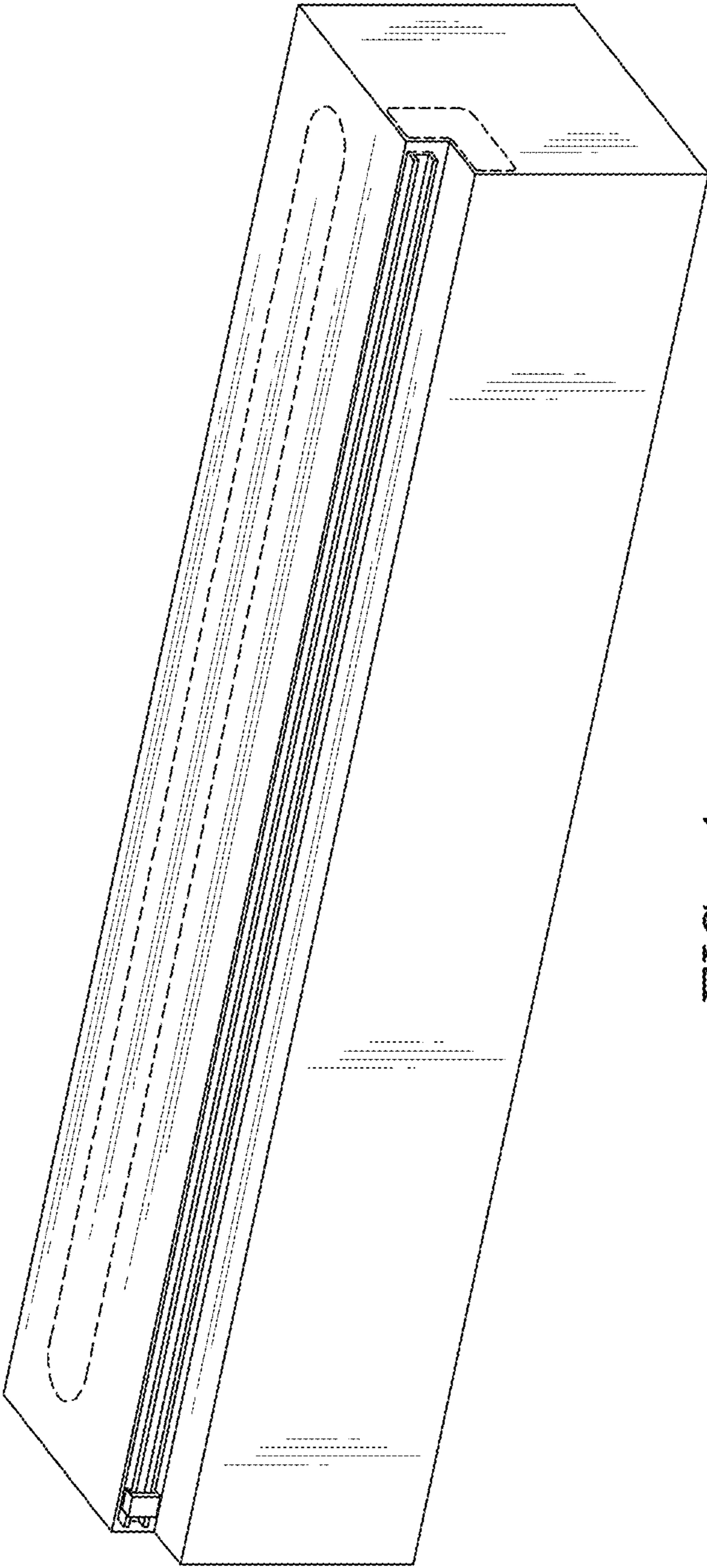

FIG. 1

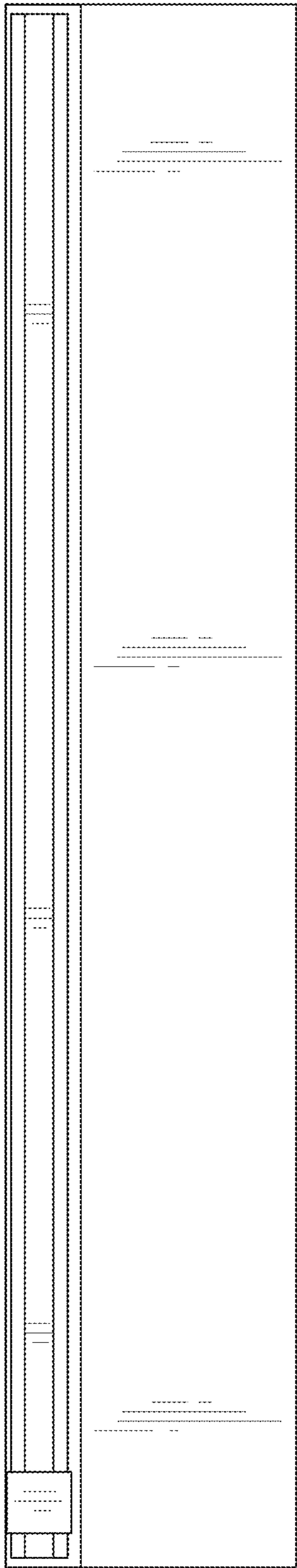

FIG. 2

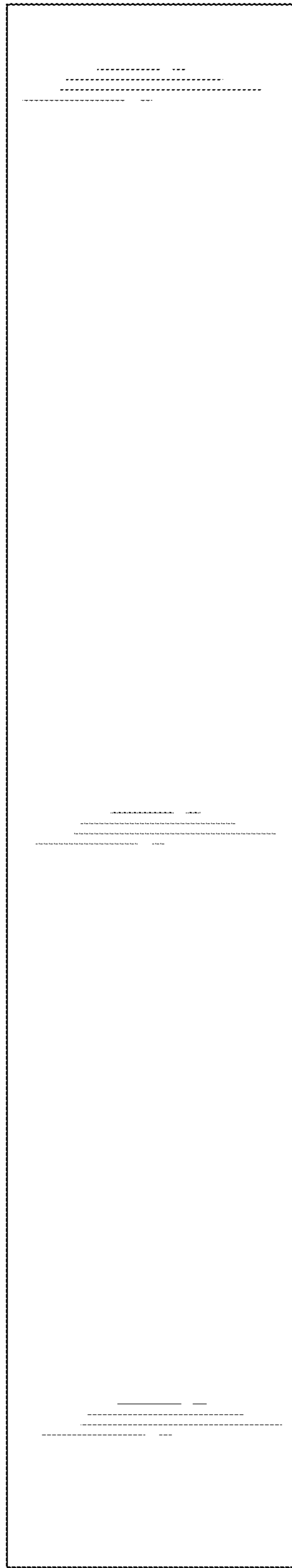

FIG. 3

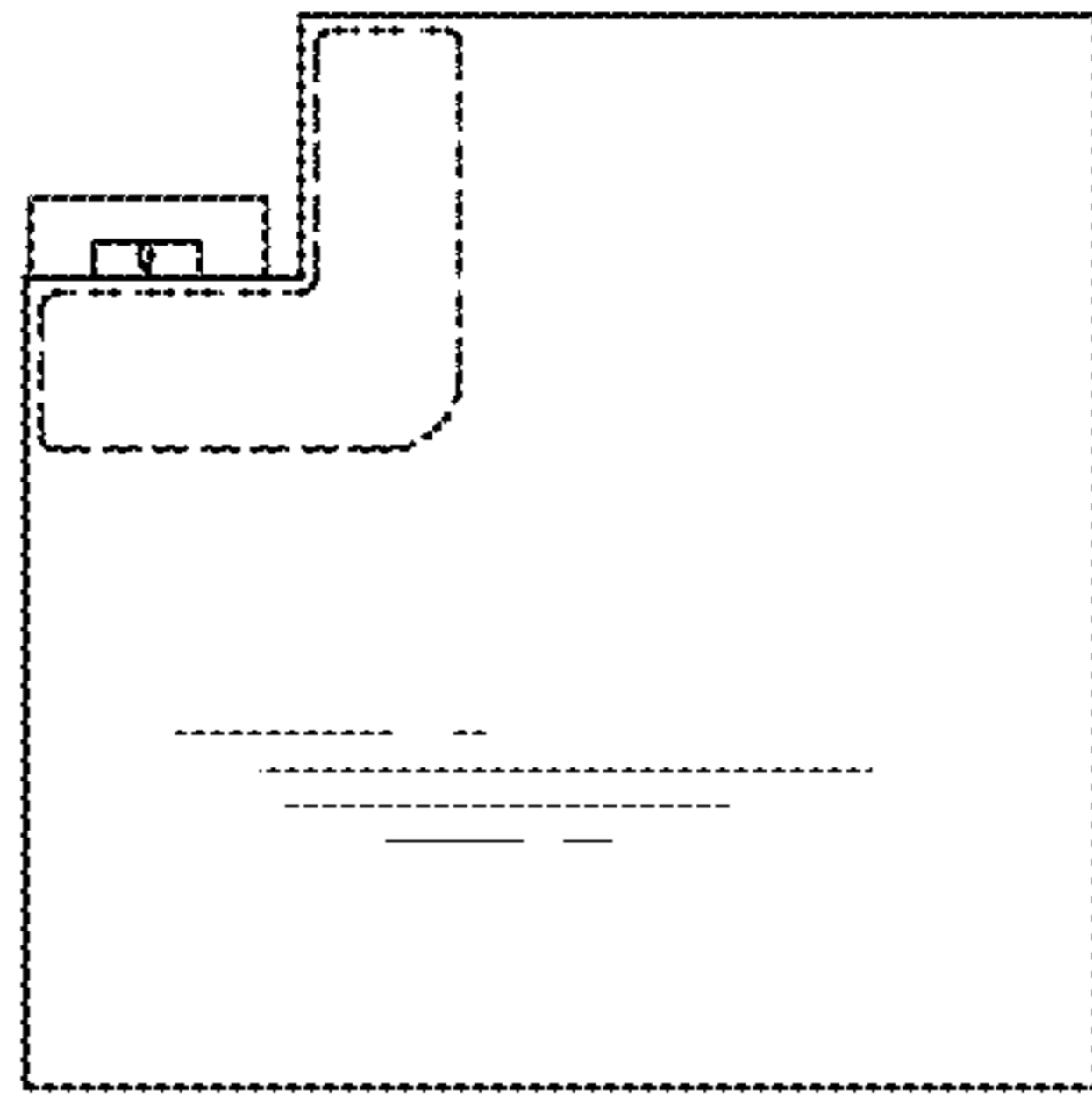

FIG. 4

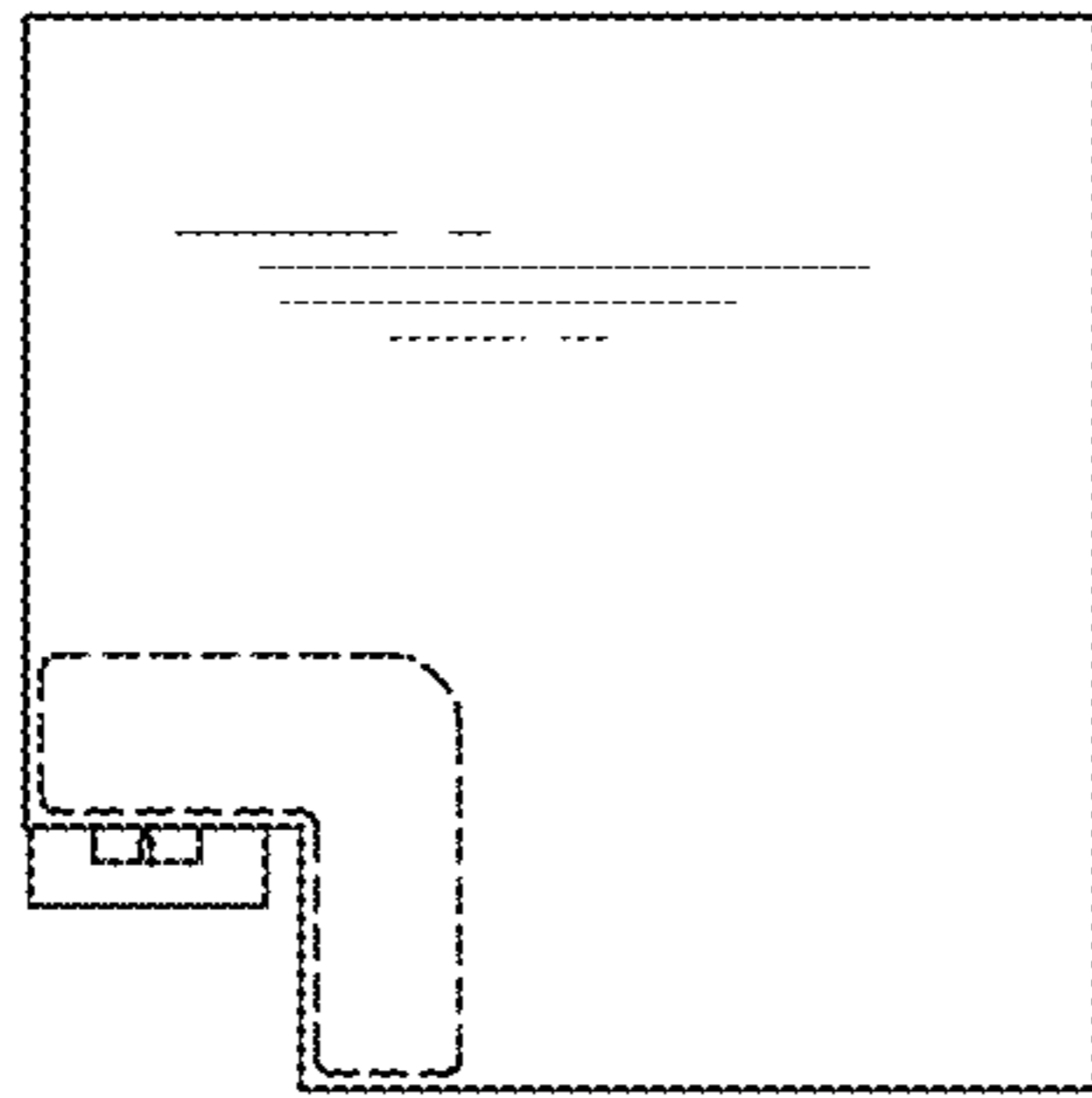

FIG. 5

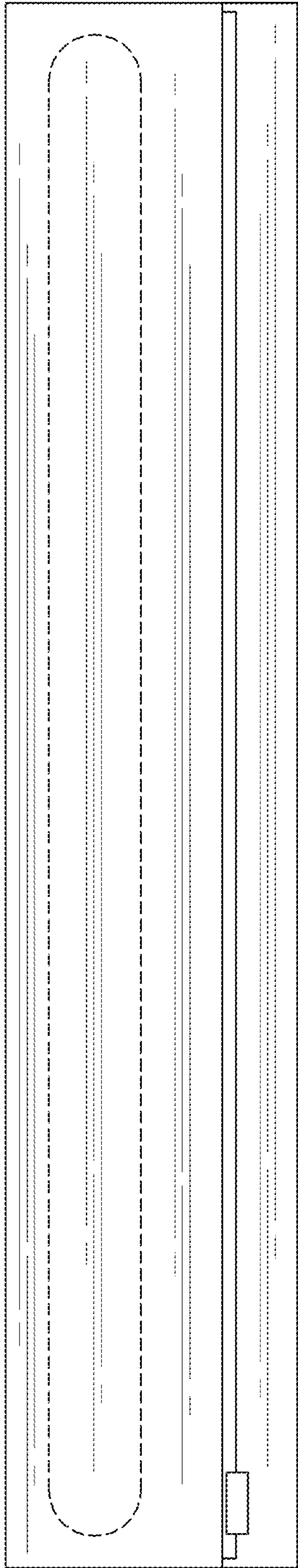

FIG. 6

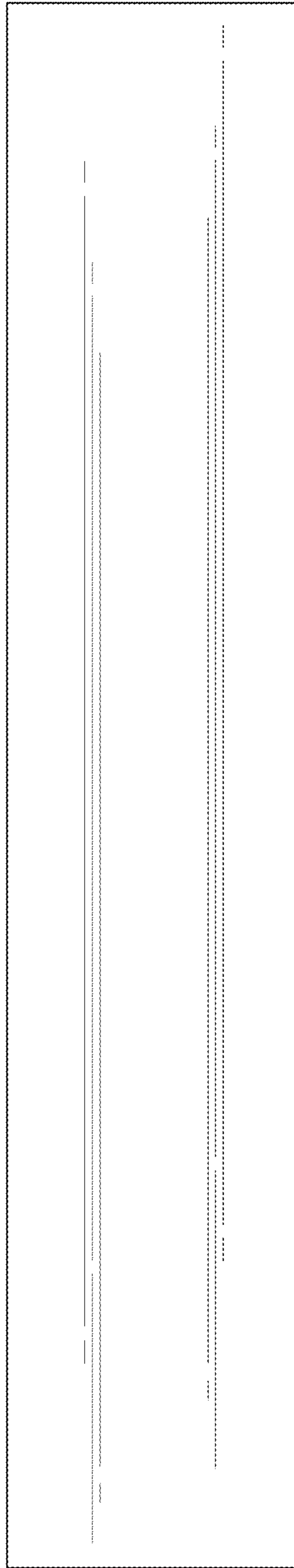

FIG. 7

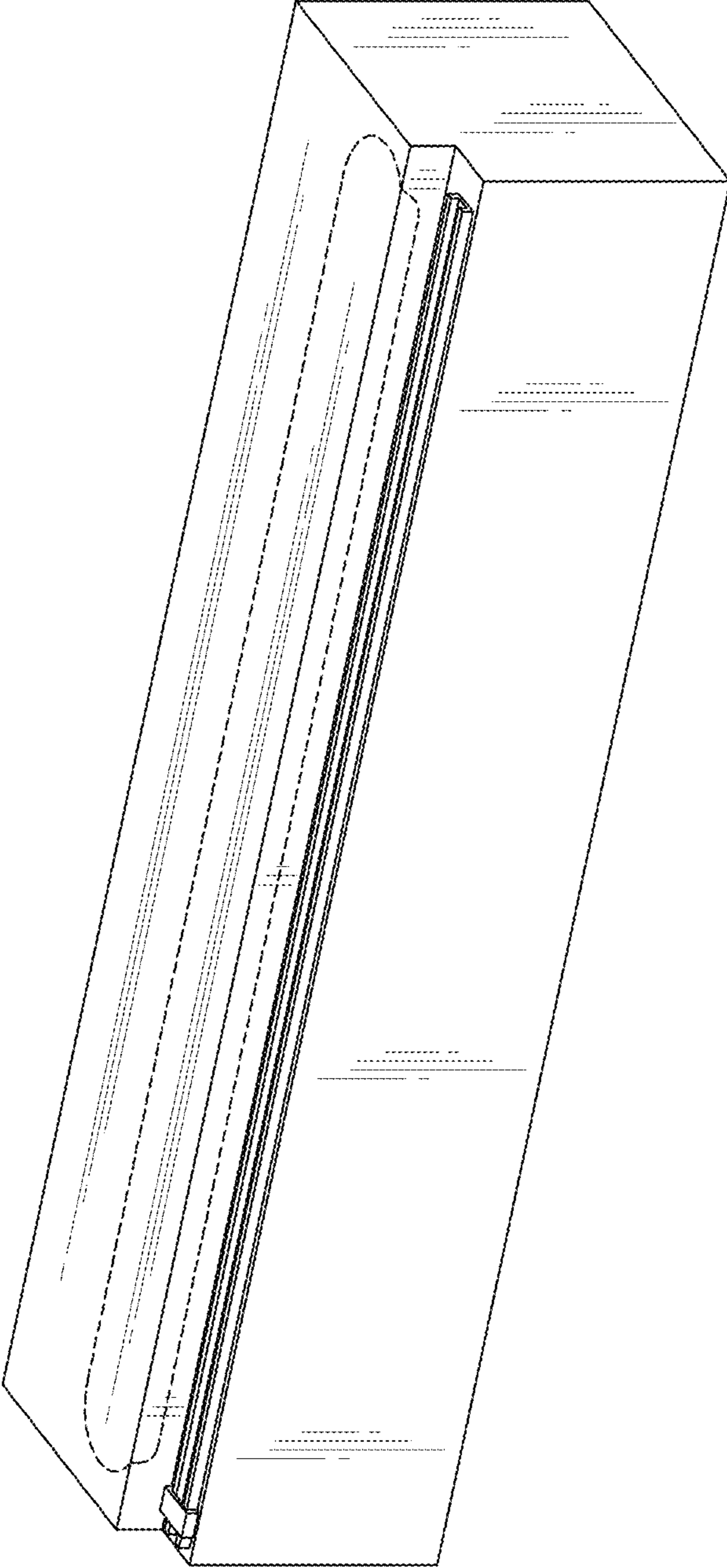

FIG. 8

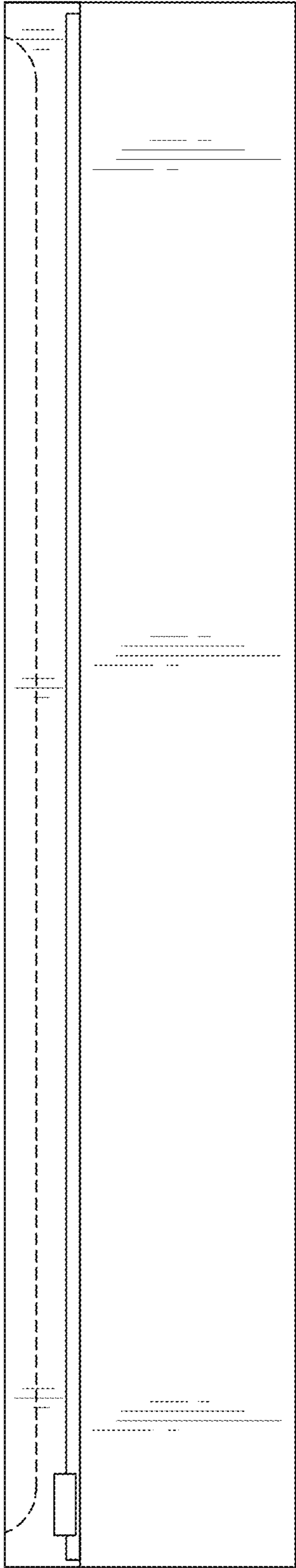

FIG. 9

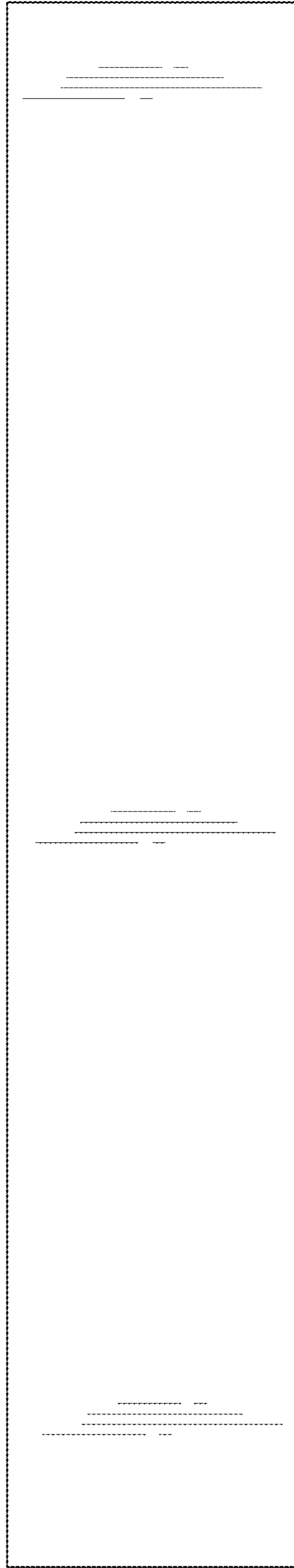

FIG. 10



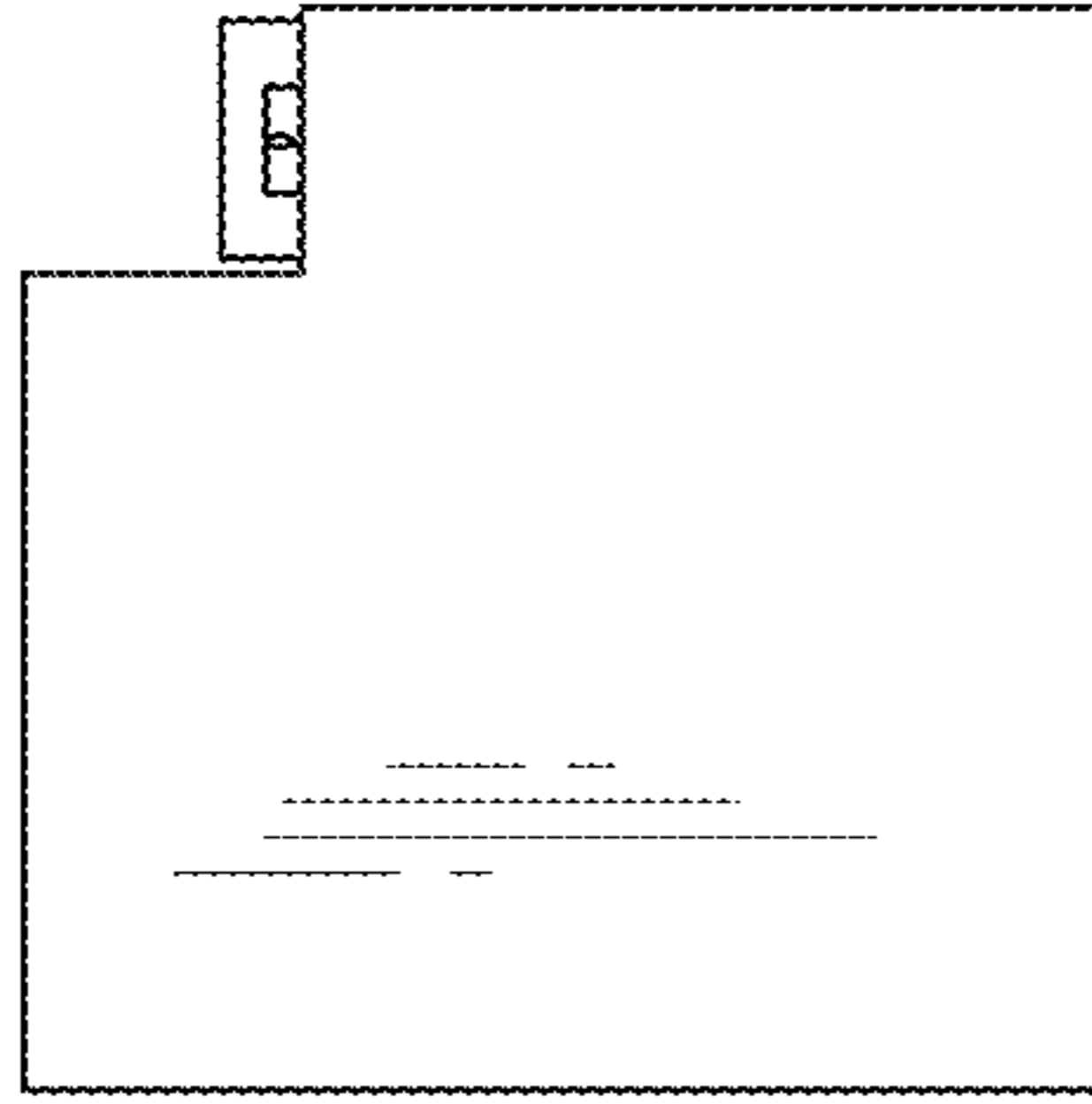

FIG. 12

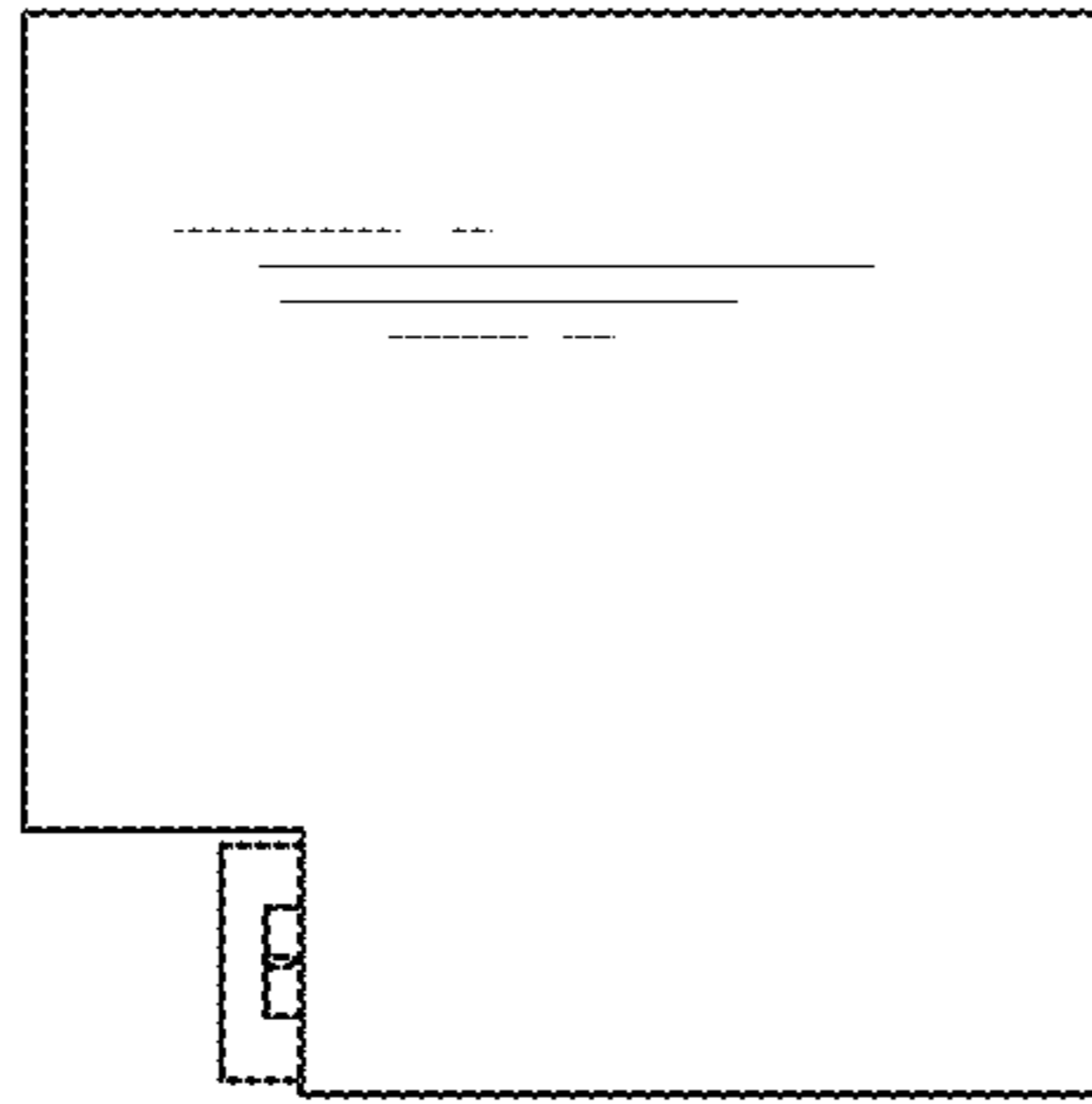

FIG. 11

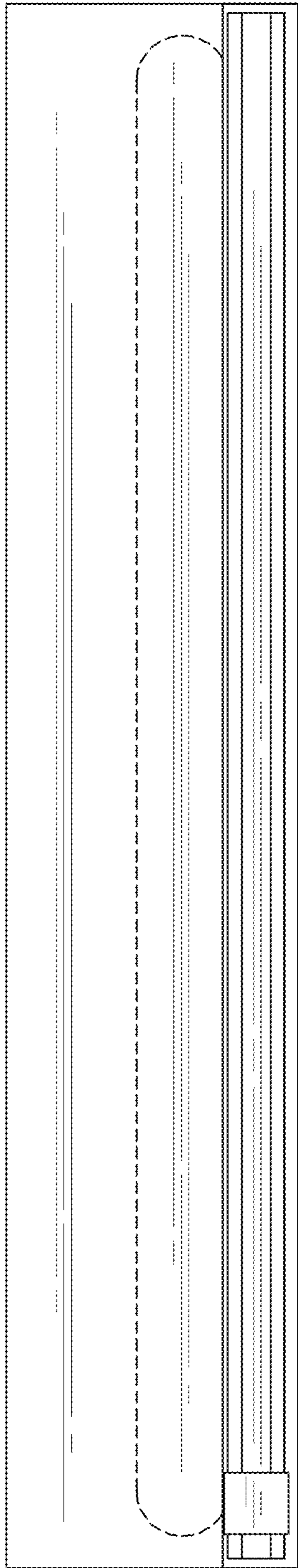

FIG. 13

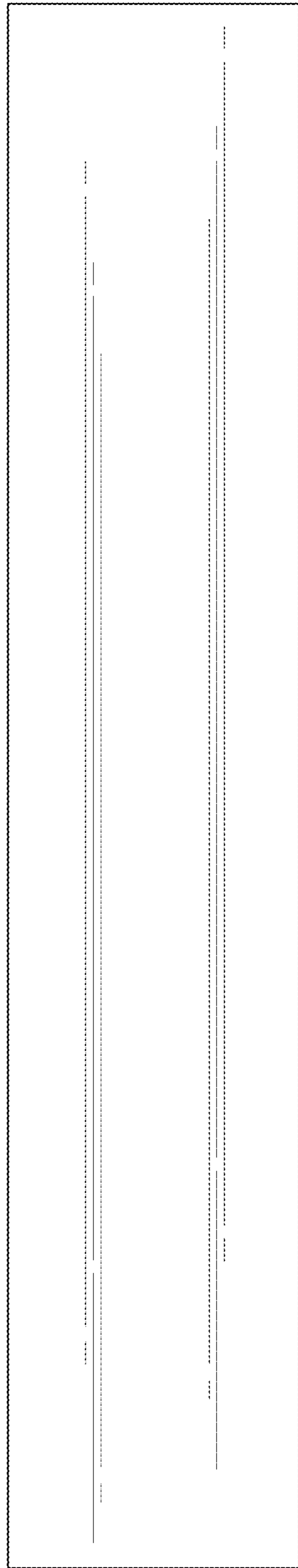

FIG. 14