



US00D815501S

(12) **United States Design Patent** (10) **Patent No.:** **US D815,501 S**  
**Huang et al.** (45) **Date of Patent:** **\*\* Apr. 17, 2018**

- (54) **GARDEN SHEARS**
- (71) Applicant: **BOR SHENG INDUSTRIAL CO., LTD.**, Taichung (TW)
- (72) Inventors: **Hsueh Hsin Huang**, Taichung (TW); **Shih-Chang Lin**, Taichung (TW)
- (73) Assignee: **BOR SHENG INDUSTRIAL CO., LTD.**, Taichung (TW)
- (\*\*) Term: **15 Years**
- (21) Appl. No.: **29/553,169**
- (22) Filed: **Jan. 29, 2016**
- (51) **LOC (11) Cl.** ..... **08-01**
- (52) **U.S. Cl.**  
USPC ..... **D8/5**
- (58) **Field of Classification Search**  
USPC ..... D8/1, 4, 5, 7, 51, 52, 54, 56, 58, 107;  
D21/532  
CPC ..... B26B 13/00; B26B 13/06; B26B 13/14;  
B26B 13/20; B26B 13/16; B26B 13/28;  
A01G 3/02; A01G 3/021; A01G 3/025;  
A01G 3/0251; A01G 3/0475  
See application file for complete search history.

- D377,588 S \* 1/1997 Birkholz ..... D8/5
- D426,433 S \* 6/2000 Hurst ..... D8/5
- D464,539 S \* 10/2002 Richwine ..... D8/5
- D496,838 S \* 10/2004 Tomchak ..... D8/5
- D509,115 S \* 9/2005 Wu ..... D8/5
- D750,455 S \* 3/2016 Wu ..... D8/5
- 2007/0266568 A1 \* 11/2007 Lin ..... A01G 3/02  
30/134

\* cited by examiner

*Primary Examiner* — Sandra S Snapp  
*Assistant Examiner* — Ieisha N Price  
(74) *Attorney, Agent, or Firm* — Raymond Y. Chan;  
David and Raymond Patent Firm

(57) **CLAIM**

The ornamental design for a garden shears, as shown and described.

**DESCRIPTION**

FIG. 1 is a front view of an garden shears showing my new design.  
FIG. 2 is a rear view thereof.  
FIG. 3 is a top view thereof.  
FIG. 4 is a bottom view thereof.  
FIG. 5 is a right view thereof.  
FIG. 6 is a left view thereof.  
FIG. 7 is a perspective view thereof.  
FIG. 8 is a perspective view of the garden shears, illustrating the garden shears with a blade; and,  
FIG. 9 is another perspective view of the garden shears, illustrating the garden shears with a different blade.  
The broken line portion of the figure drawings is included to show unclaimed subject matter only and forms no part of the claimed design.

**1 Claim, 9 Drawing Sheets**

(56) **References Cited**

**U.S. PATENT DOCUMENTS**

- D264,172 S \* 5/1982 Harrison ..... D8/5
- D305,090 S \* 12/1989 Collins ..... D8/107
- D336,222 S \* 6/1993 Wensley ..... D8/5
- D336,412 S \* 6/1993 Wensley ..... D8/5
- D341,526 S \* 11/1993 Clivio ..... D8/5
- D342,652 S \* 12/1993 Wensley ..... D8/5

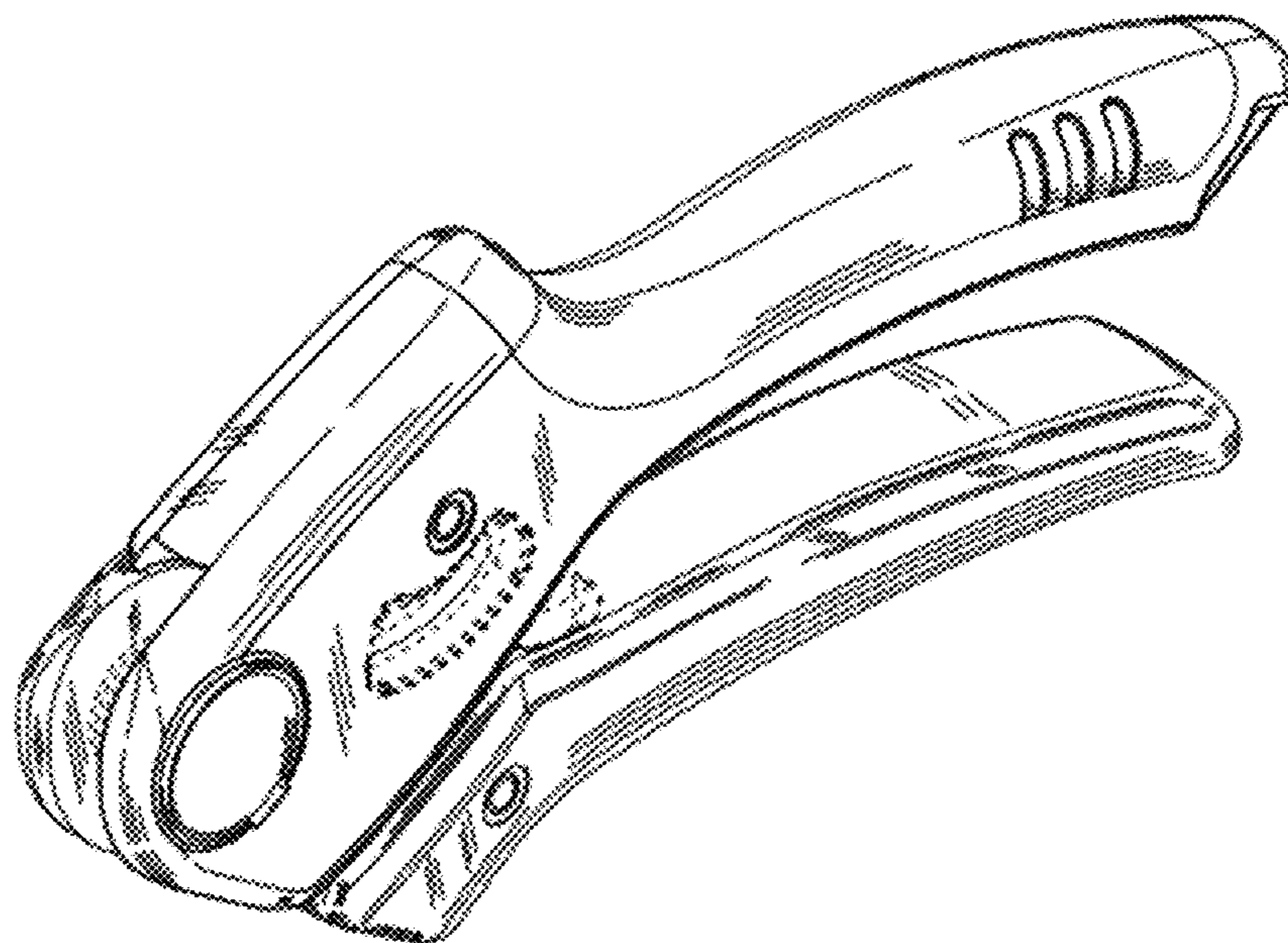

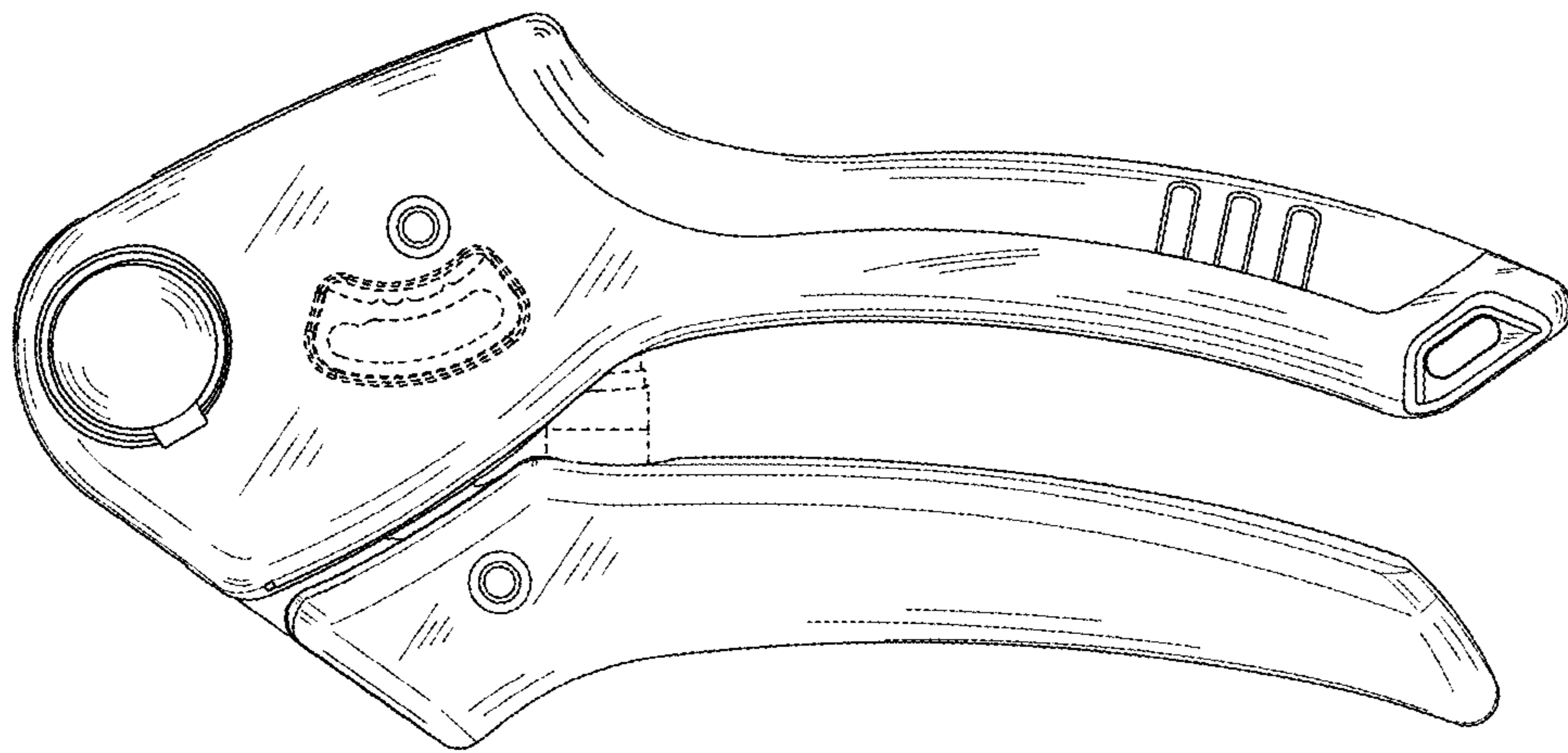

FIG 1

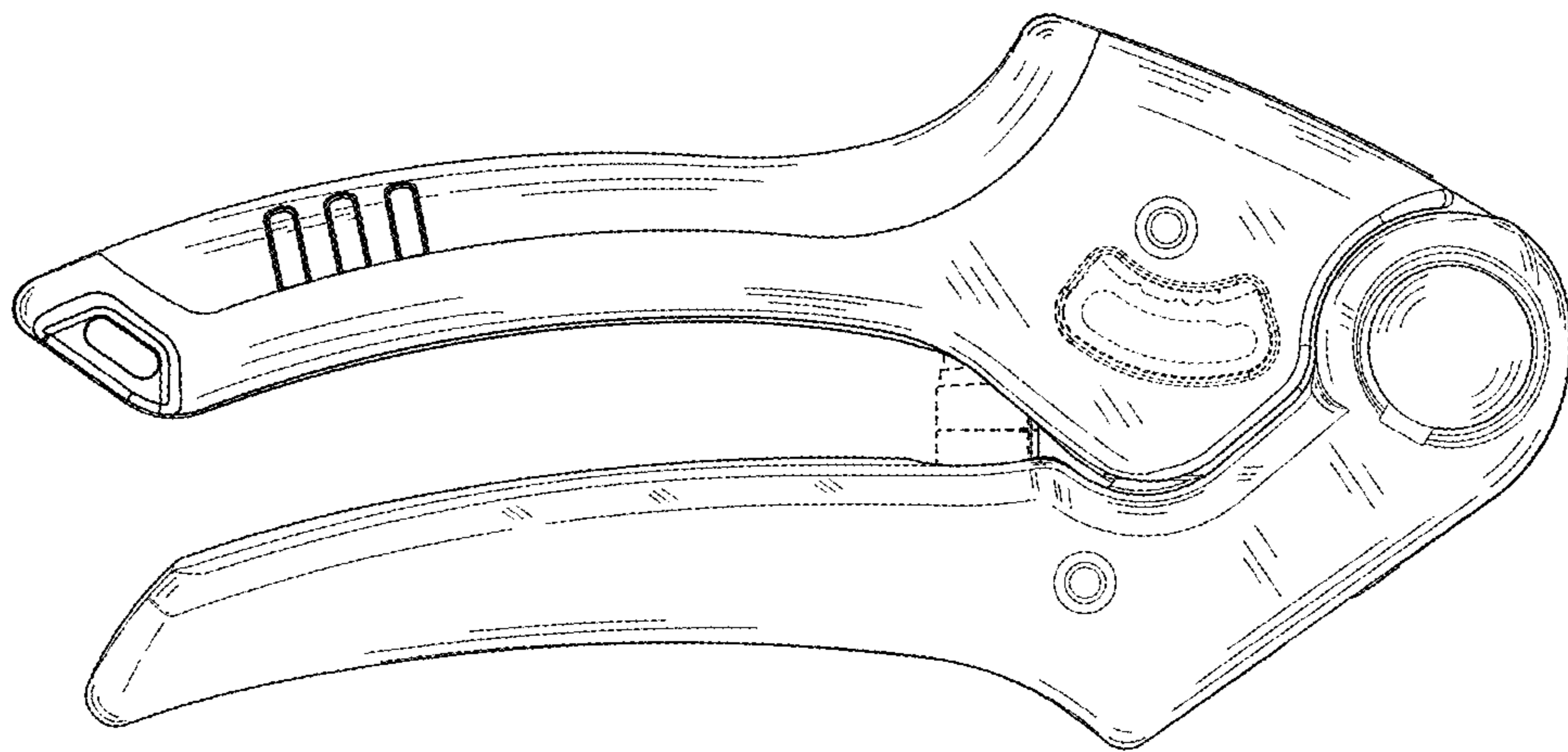

FIG 2

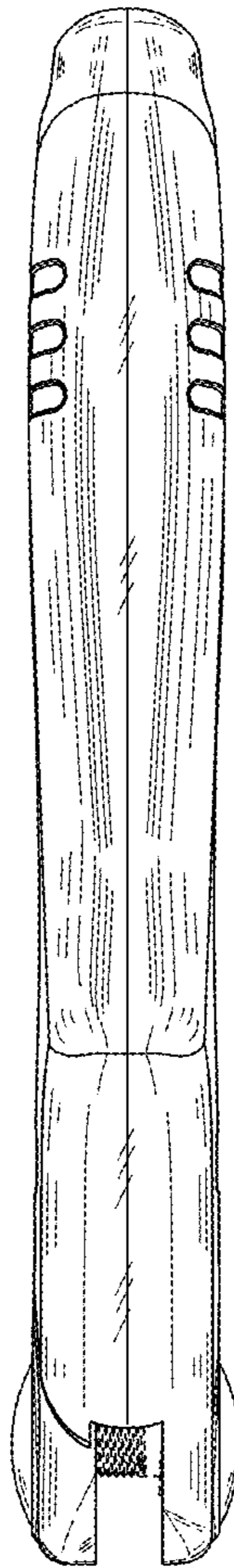

FIG 3

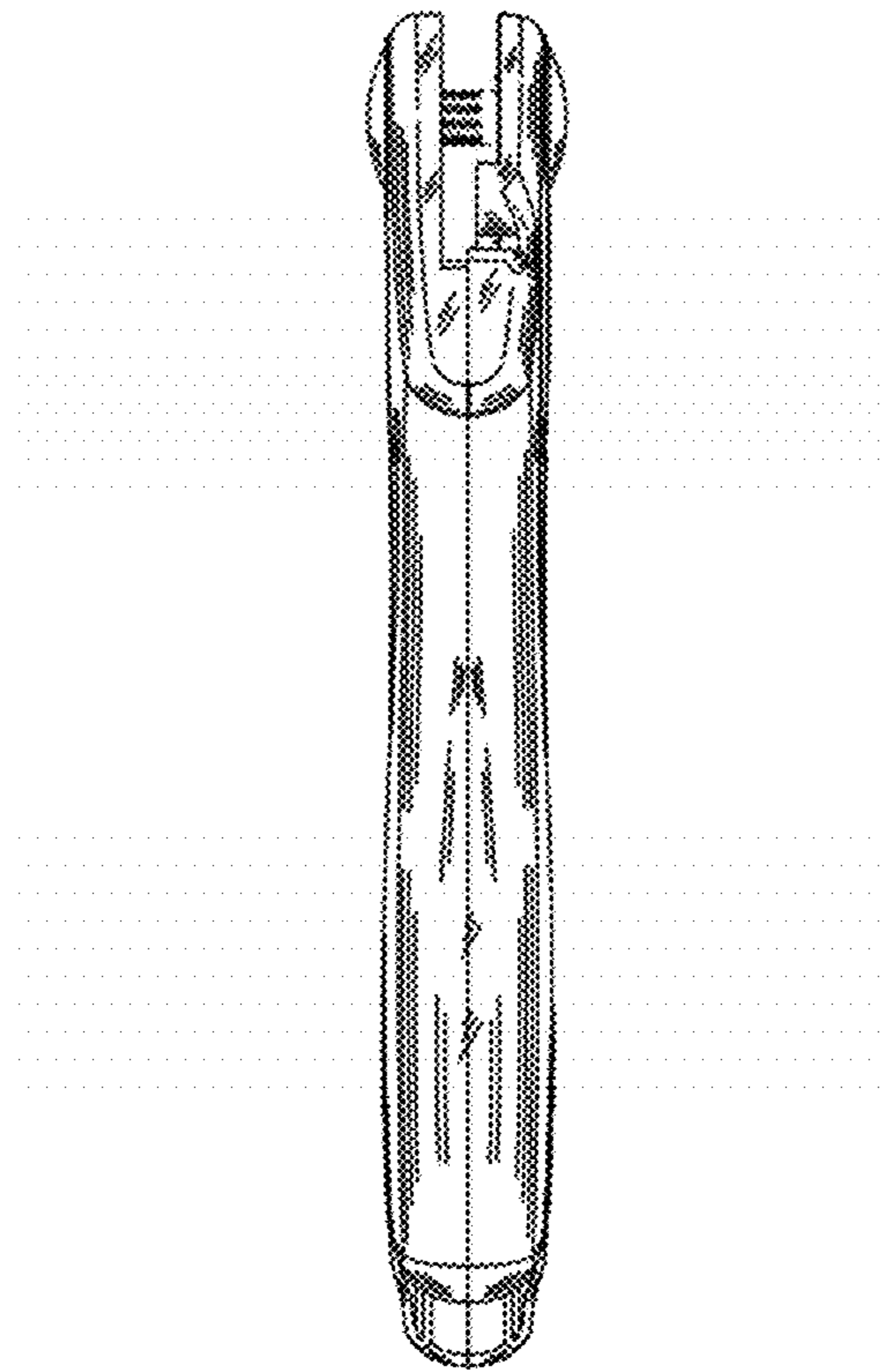

FIG 4

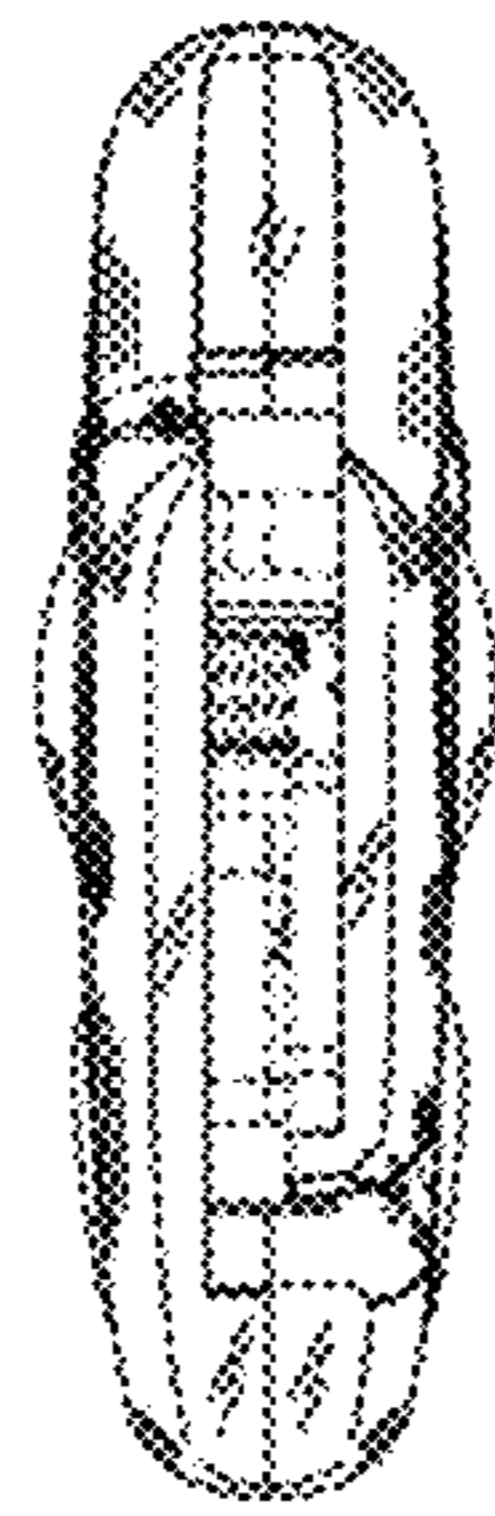

FIG 5

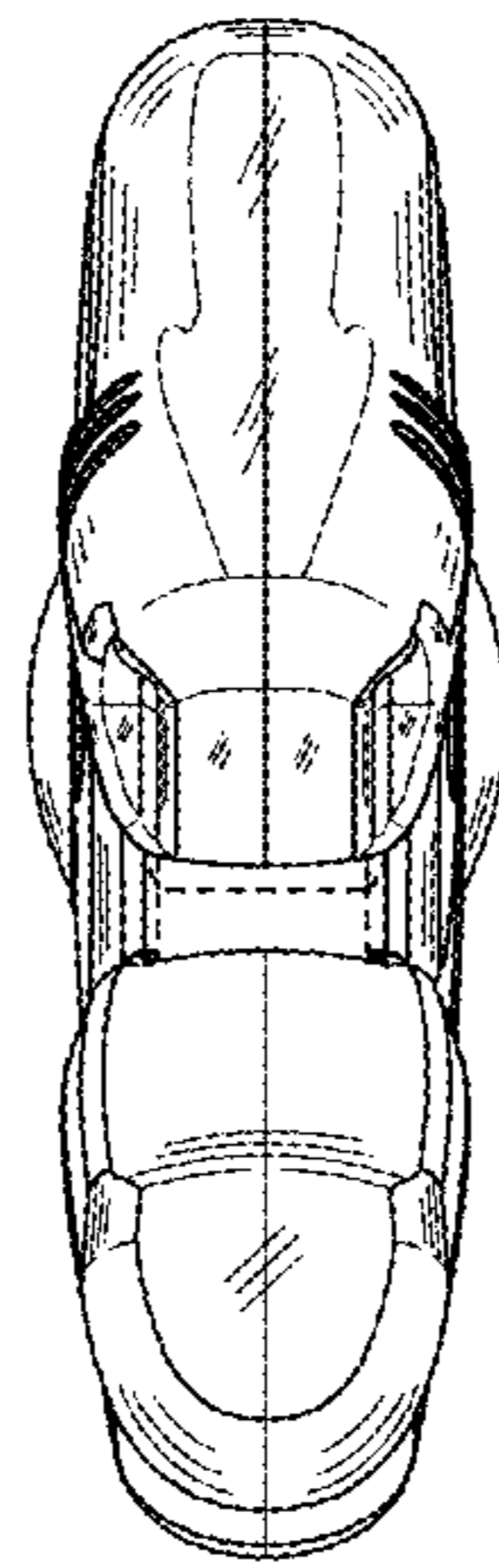

FIG 6

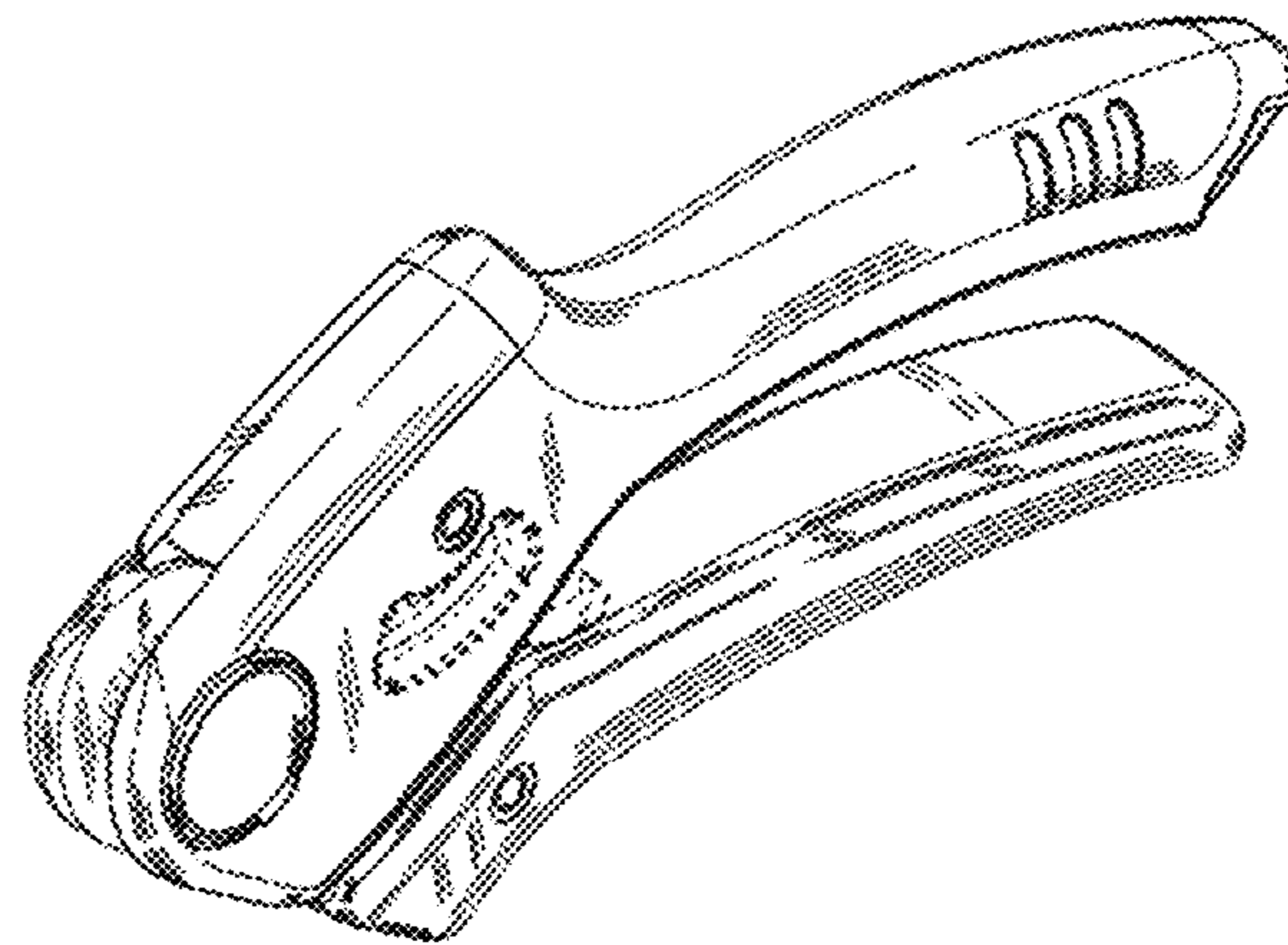

FIG 7



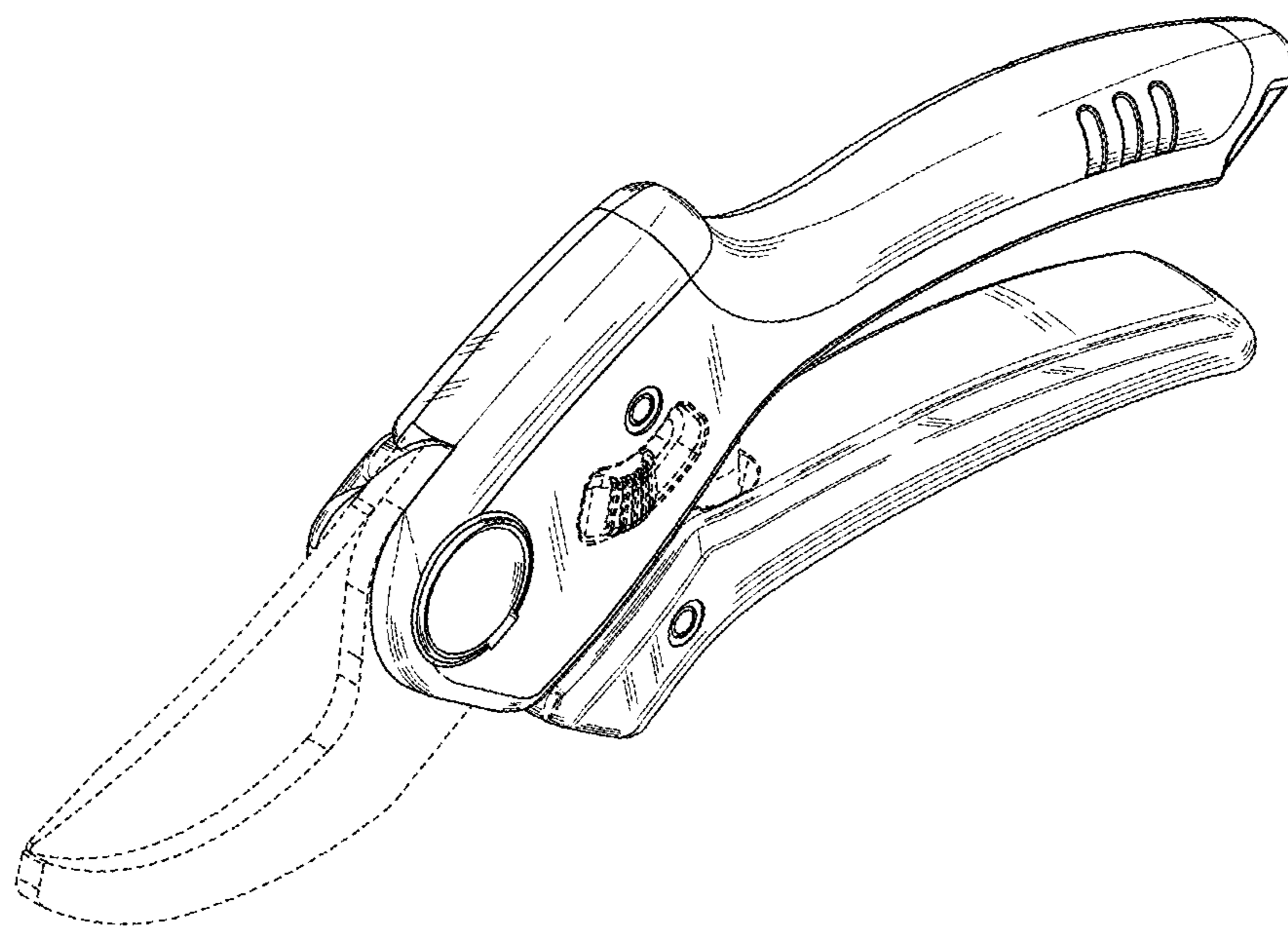

FIG 8

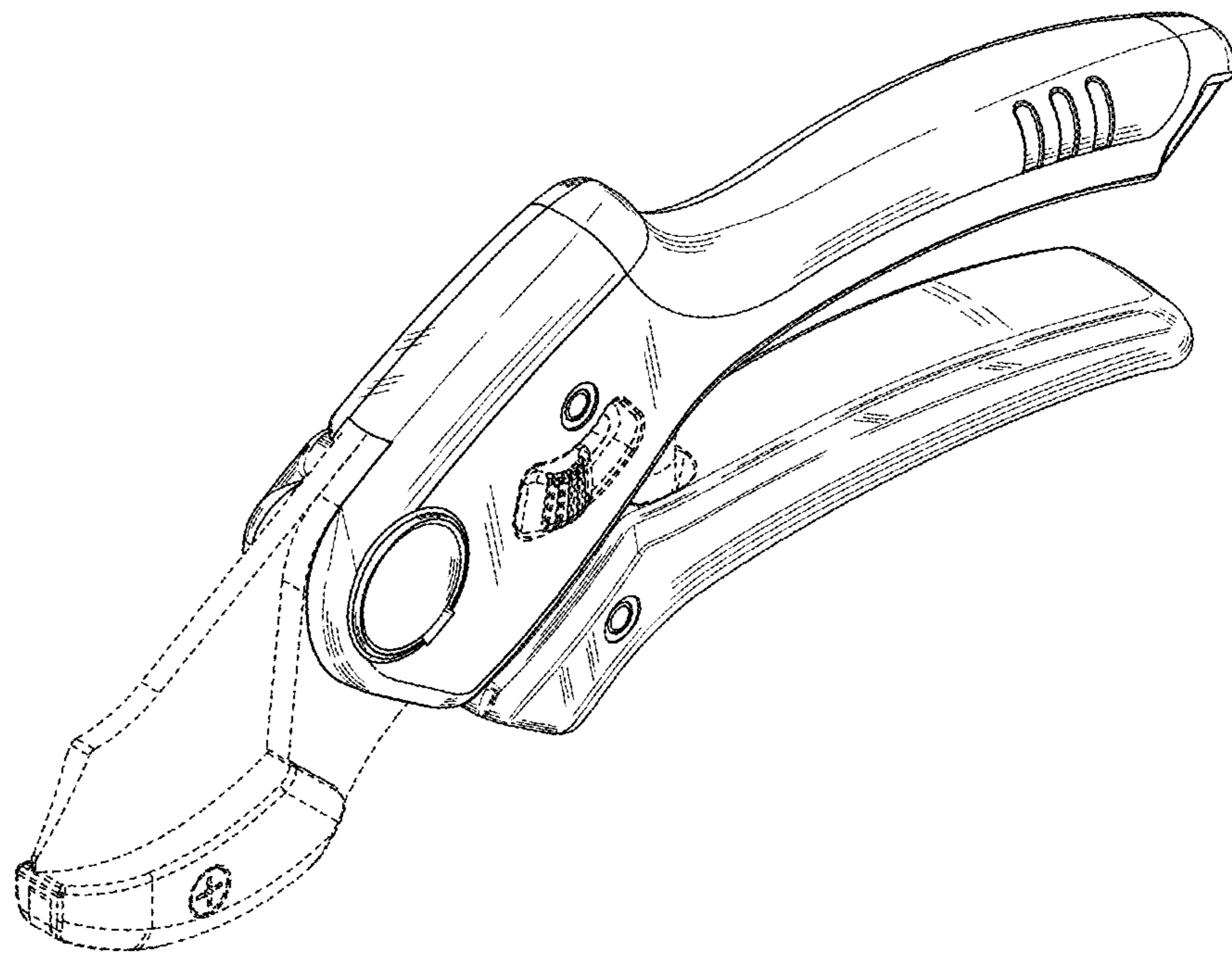

FIG 9