



US00D815492S

(12) **United States Design Patent** (10) **Patent No.:** **US D815,492 S**
Bo (45) **Date of Patent:** **** Apr. 17, 2018**

(54) **TUMBLER**
(71) Applicant: **Anhui Inno-Sign International Co., Ltd.**, Hefei (CN)
(72) Inventor: **Jin Bo**, Hefei (CN)
(73) Assignee: **Anhui Inno-Sign Int'l Co., Ltd**, Hefei (CN)
(**) Term: **15 Years**
(21) Appl. No.: **29/568,593**
(22) Filed: **Jun. 20, 2016**
(51) **LOC (11) Cl.** **07-01**
(52) **U.S. Cl.**
USPC **D7/523**; D7/509; D9/559
(58) **Field of Classification Search**
USPC D7/312-314, 317, 318, 507, 509, 511, D7/601, 602, 608, 396.2; D9/447, 449, D9/504, 549, 559; 220/669, 675
CPC B65D 1/44
See application file for complete search history.

(56) **References Cited**
U.S. PATENT DOCUMENTS
6,311,861 B1 * 11/2001 Policappelli B65D 1/16 220/669
D457,034 S * 5/2002 Bodum D7/510
D457,783 S * 5/2002 Bodum D7/510
D513,931 S * 1/2006 Liu D7/511
D530,153 S * 10/2006 Karp D7/510

D535,152 S * 1/2007 Gluck D7/509
D567,094 S * 4/2008 Bickert D9/529
D607,698 S * 1/2010 Tsukida D7/608
D707,087 S * 6/2014 Joy D7/607
D722,828 S * 2/2015 Shamoon D7/510
D783,369 S * 4/2017 Matsuo D7/608
2001/0027978 A1 * 10/2001 Finlay B65D 1/44 220/669

* cited by examiner
Primary Examiner — Daniel D Bui
Assistant Examiner — Andrew Kerr
(74) *Attorney, Agent, or Firm* — Richards Patent Law P.C.

(57) **CLAIM**
The ornamental design for a tumbler, as shown and described.

DESCRIPTION
FIG. 1 is a perspective view of a tumbler showing my new design;
FIG. 2 is a front view thereof;
FIG. 3 is a back view thereof;
FIG. 4 is a right side view thereof;
FIG. 5 is a left side view thereof;
FIG. 6 is a top view thereof; and,
FIG. 7 is a bottom view thereof.
The broken lines in the drawing views represent unclaimed portions of a tumbler, which are included for the purpose of illustrating unclaimed environment only, and form no part of the claimed design.

1 Claim, 6 Drawing Sheets

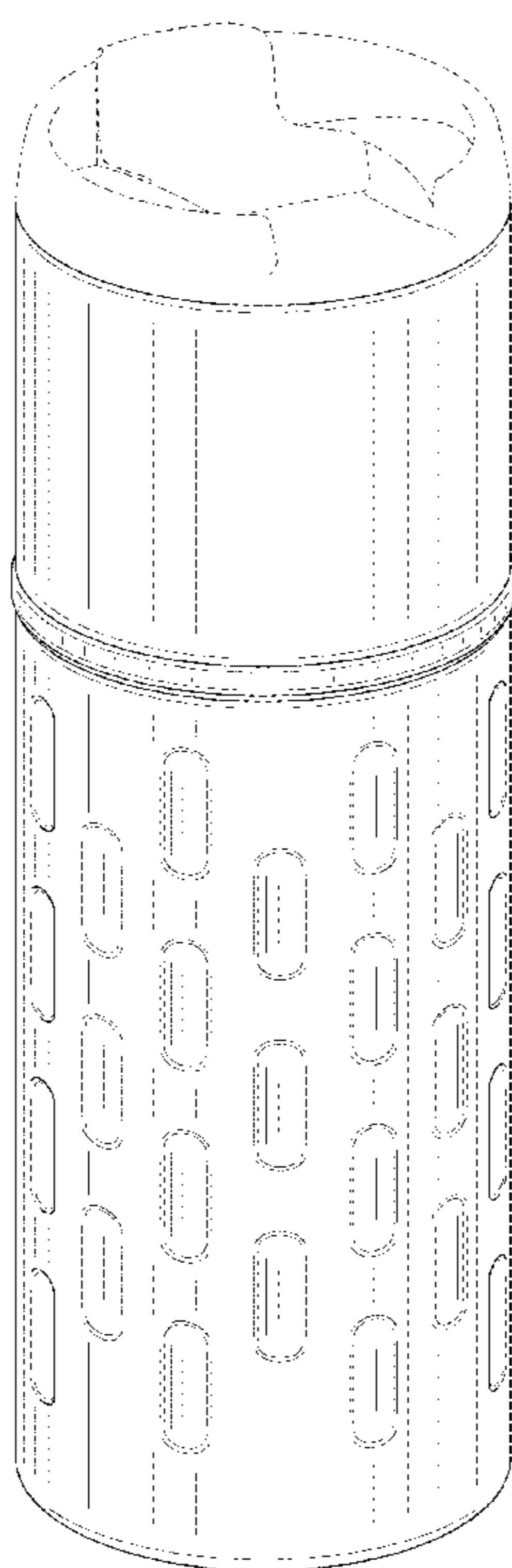

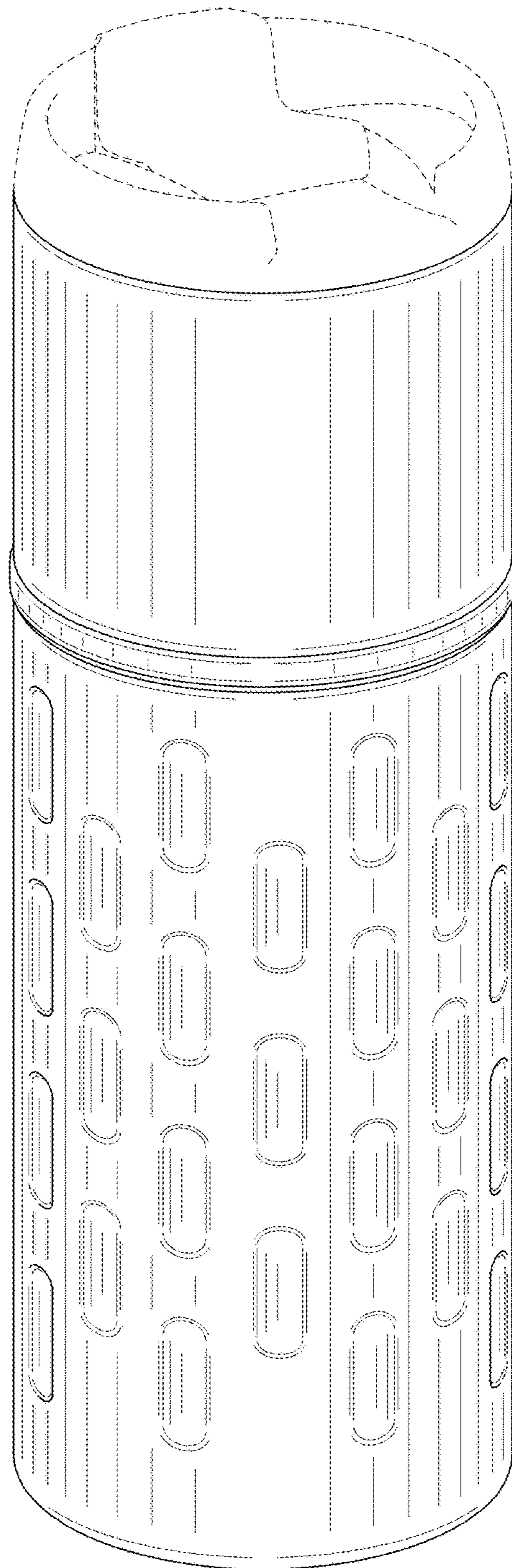

FIG. 1

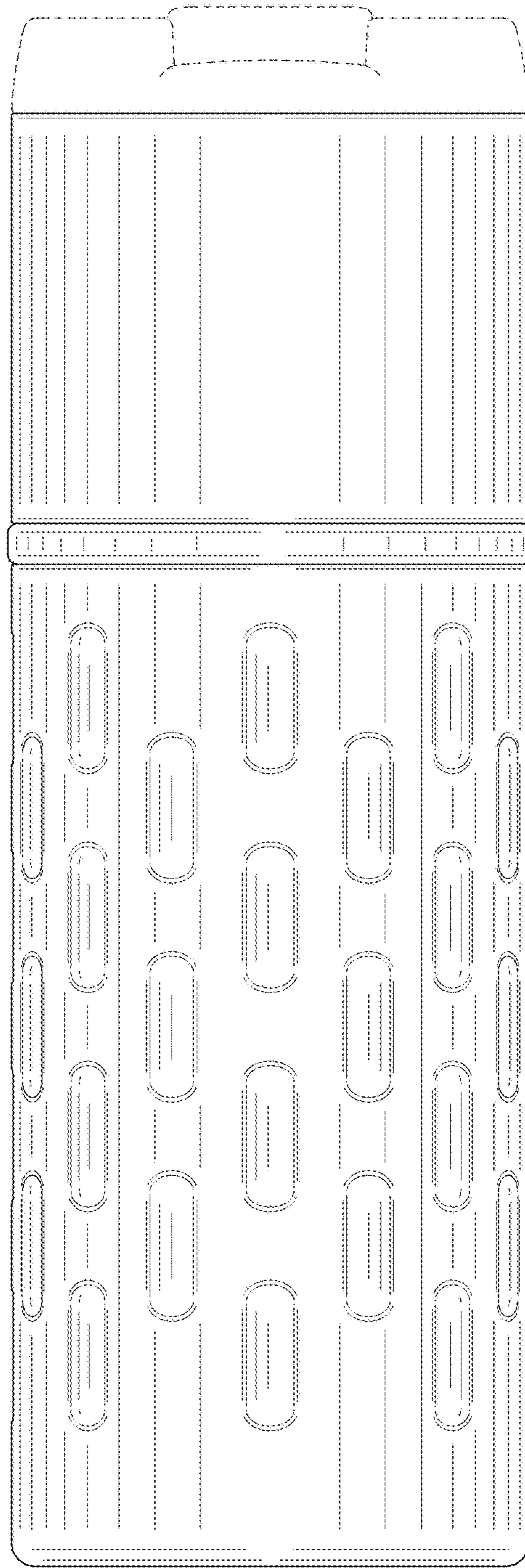

FIG. 2

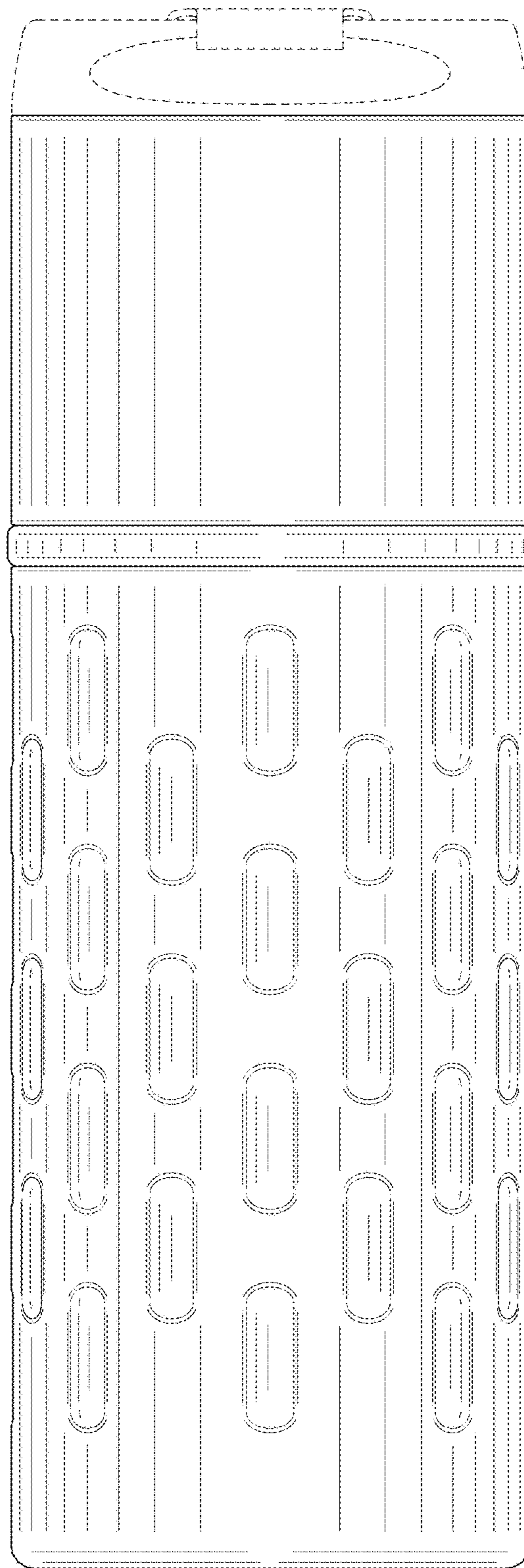

FIG. 3

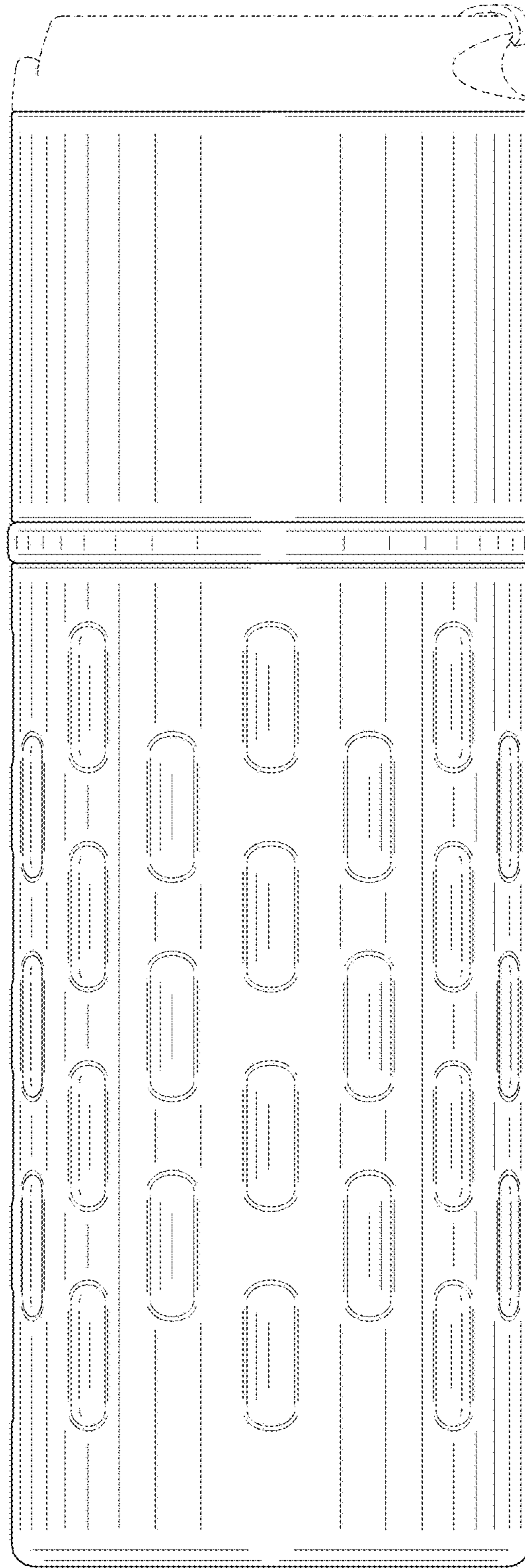

FIG. 4

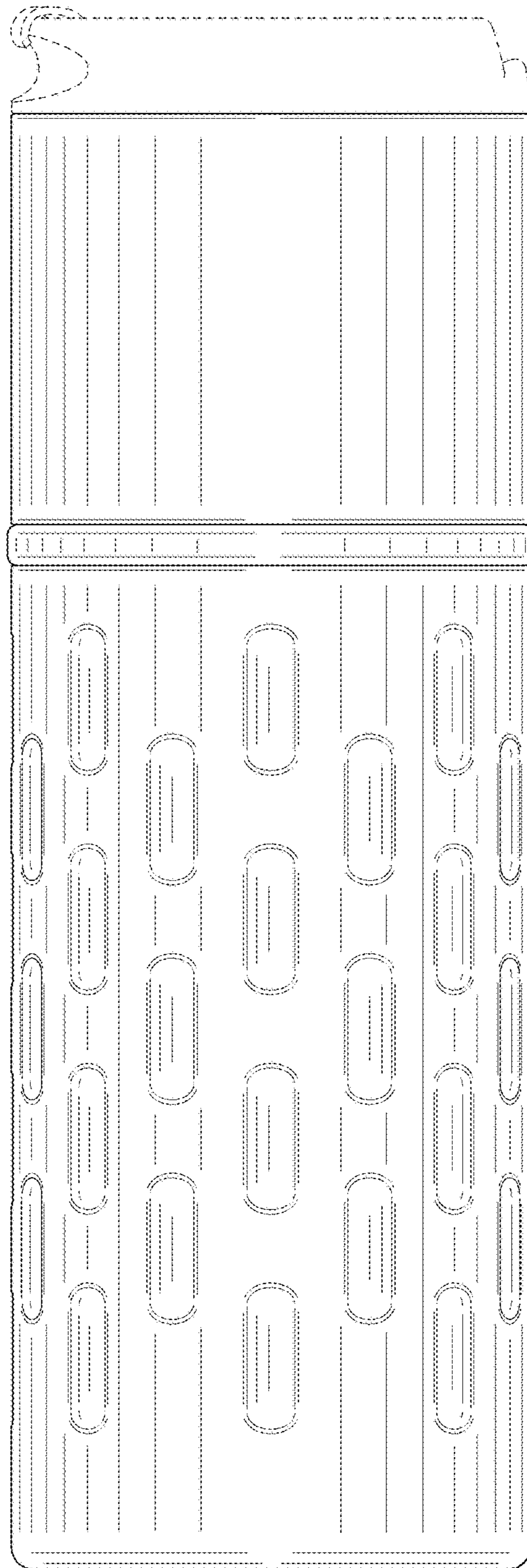

FIG. 5

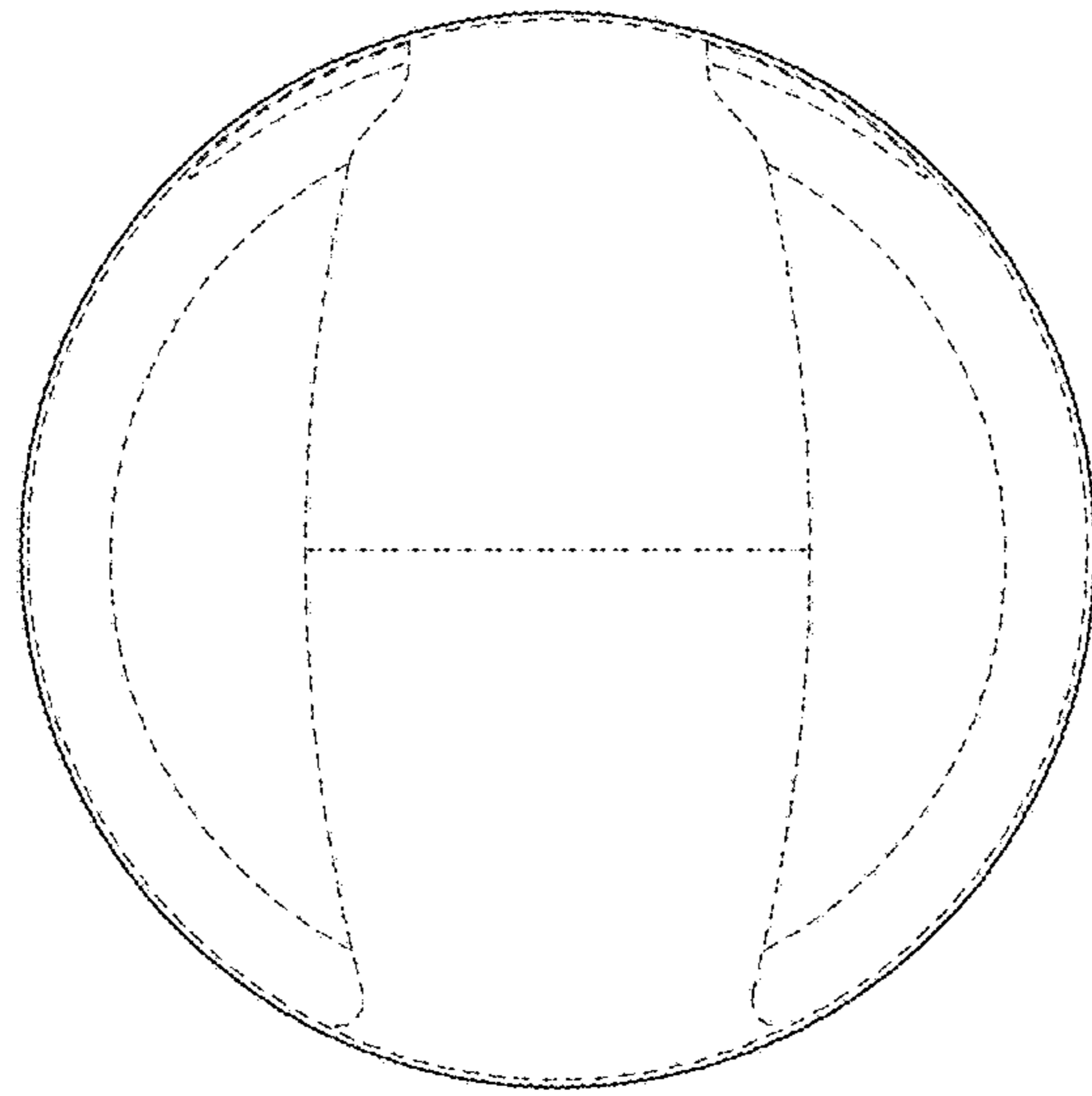

FIG. 6

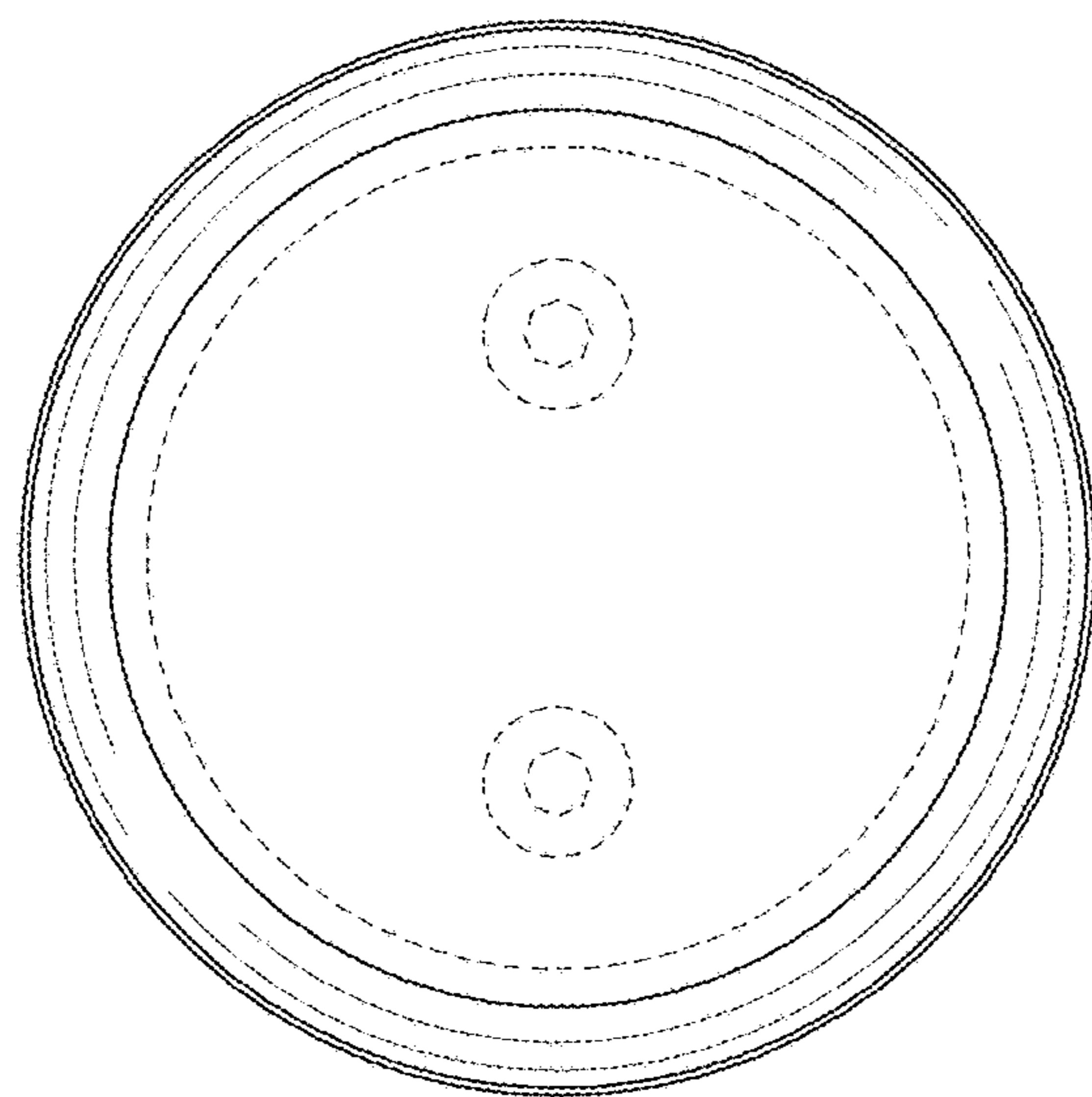

FIG. 7