



US00D815467S

(12) **United States Design Patent** (10) **Patent No.:** **US D815,467 S**  
**Hannoosh et al.** (45) **Date of Patent:** **\*\* Apr. 17, 2018**

(54) **DRESSER**  
(71) Applicant: **Williams-Sonoma, Inc.**, San Francisco, CA (US)  
(72) Inventors: **Jeffrey C. Hannoosh**, Brooklyn, NY (US); **August Knox**, Brooklyn, NY (US)  
(73) Assignee: **Williams-Sonoma, Inc.**, San Francisco, CA (US)  
(\*\*) Term: **15 Years**

(21) Appl. No.: **29/590,539**  
(22) Filed: **Jan. 11, 2017**  
(51) **LOC (11) Cl.** ..... **06-04**  
(52) **U.S. Cl.**  
USPC ..... **D6/671.1**

(58) **Field of Classification Search**  
USPC ..... D5/15, 16, 28, 29, 99; D6/661, 663, D6/668.1, 668.2, 669, 671, 671.1, 671.2, D6/705; D25/48.4, 113, 163  
CPC ..... A47B 55/02; A47B 3/00; A47B 81/005; A47B 81/00; A47B 67/02; A47B 77/02; A47B 47/05; A47B 47/024; A47B 47/0066; A47B 87/005; A47B 87/0292; A47B 43/00; A47B 88/49; A47B 88/90; A47G 1/12; A47F 3/002; A47F 3/0413; A47F 5/08; A47F 5/116; A47F 5/0018; A45C 11/16; B42F 17/00; E05C 19/001; F25D 21/14; F25D 23/069; F25D 2400/10; G09F 1/12; H05K 9/0062; Y10T 428/24694

See application file for complete search history.

(56) **References Cited**

**U.S. PATENT DOCUMENTS**

D165,241 S \* 11/1951 Porter ..... D6/671.1  
D165,243 S \* 11/1951 Porter ..... D6/671.1

D167,770 S \* 9/1952 Porter ..... D6/671.1  
D178,055 S \* 6/1956 Hermann ..... D6/657  
D182,839 S \* 5/1958 Lubberts et al. .... D6/657  
D183,847 S \* 11/1958 Lubberts ..... D6/671.1  
D185,936 S \* 8/1959 Banks ..... D6/671.1  
D187,232 S \* 2/1960 Matyas ..... D18/59  
D190,179 S \* 4/1961 Swarts ..... D6/671.1  
D363,176 S \* 10/1995 Berry, Jr. .... D6/691.2  
D414,628 S \* 10/1999 Gager ..... D6/671.1  
D427,453 S \* 7/2000 Lacroix ..... D6/671.1  
D439,076 S \* 3/2001 Mathieu ..... D6/671.1  
D533,732 S \* 12/2006 Juneau ..... D6/671.1  
D553,879 S \* 10/2007 Juneau ..... D6/671.1  
D554,893 S \* 11/2007 Boerner ..... D6/671.2  
D560,077 S \* 1/2008 Zambelli ..... D6/661  
D598,672 S \* 8/2009 Maly ..... D6/671.1  
D637,834 S \* 5/2011 Lewis ..... D6/671.1  
D655,946 S \* 3/2012 Sexton ..... D6/661

\* cited by examiner

*Primary Examiner* — Kevin K Rudzinski  
*Assistant Examiner* — Paul D Bohannon  
(74) *Attorney, Agent, or Firm* — Cook Alex Ltd.; R. Blake Johnston

(57) **CLAIM**

The ornamental design for a dresser, as shown and described.

**DESCRIPTION**

FIG. 1 is a perspective view of the dresser;  
FIG. 2 is a front elevational view of the dresser;  
FIG. 3 is a rear elevational view of the dresser;  
FIG. 4 is a left side elevational view of the dresser, the opposite side of which is a mirror image;  
FIG. 5 is a top plan view of the dresser; and,  
FIG. 6 is a bottom plan view of the dresser.

**1 Claim, 6 Drawing Sheets**

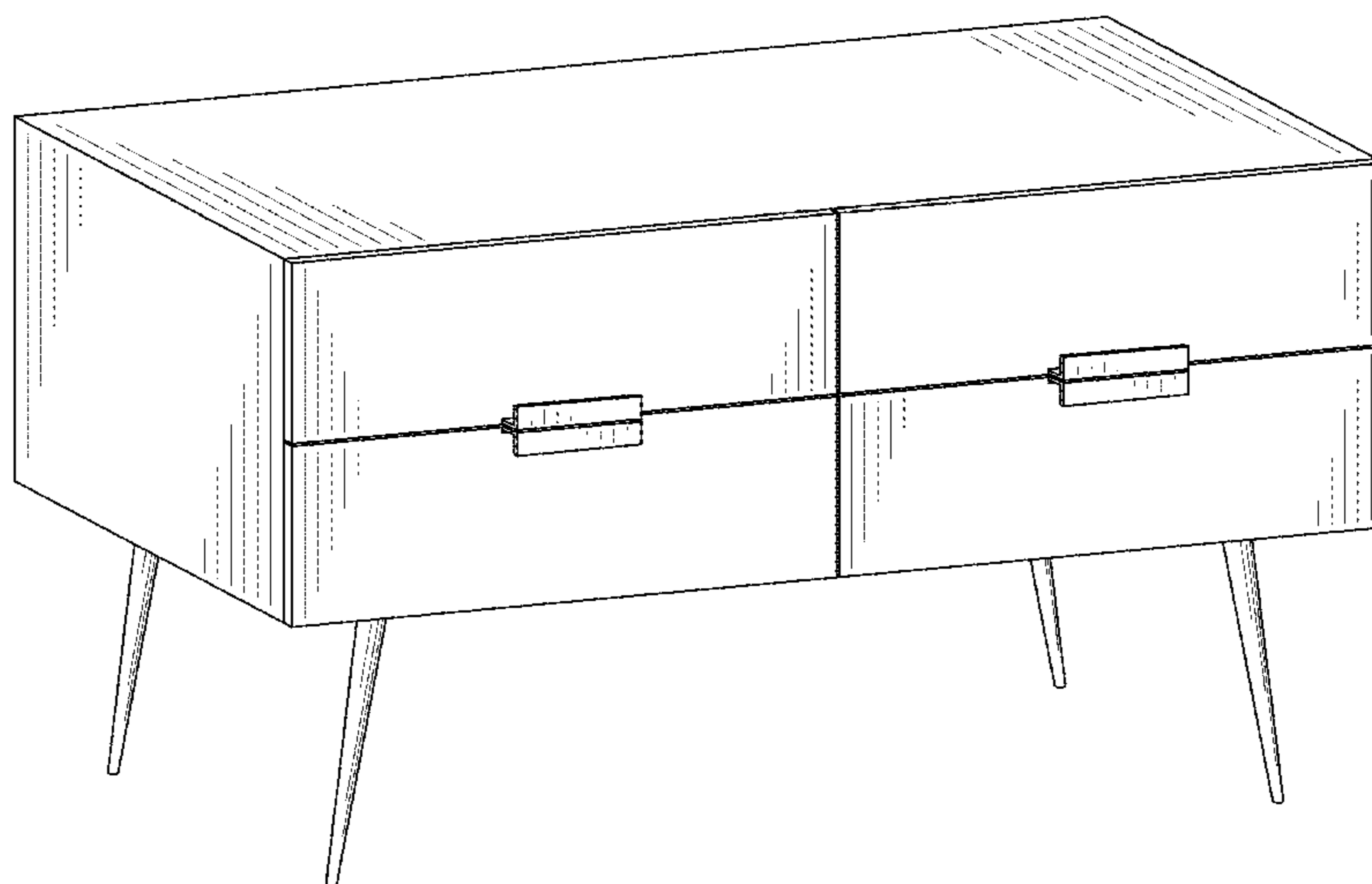

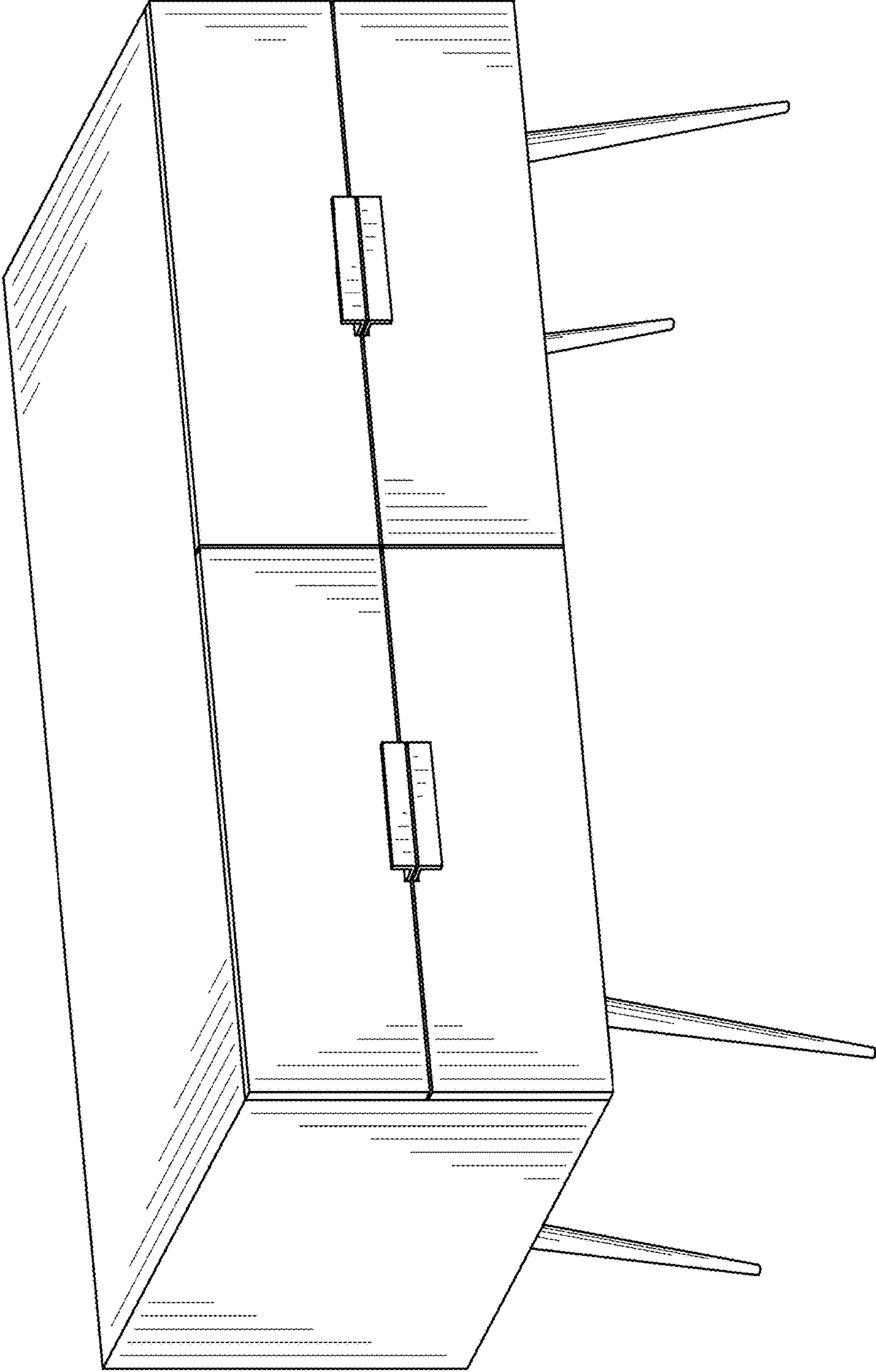

FIG. 1

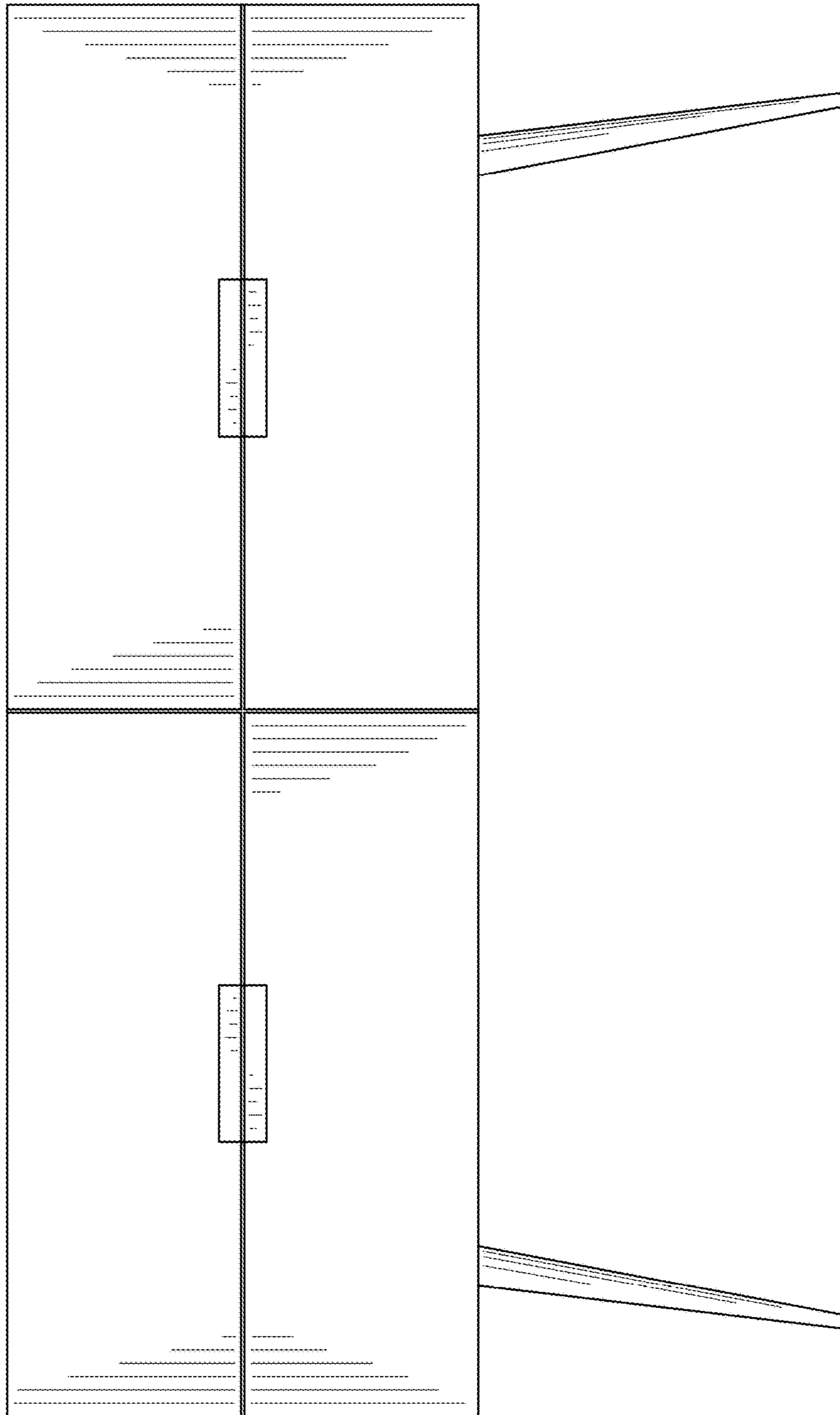

FIG. 2

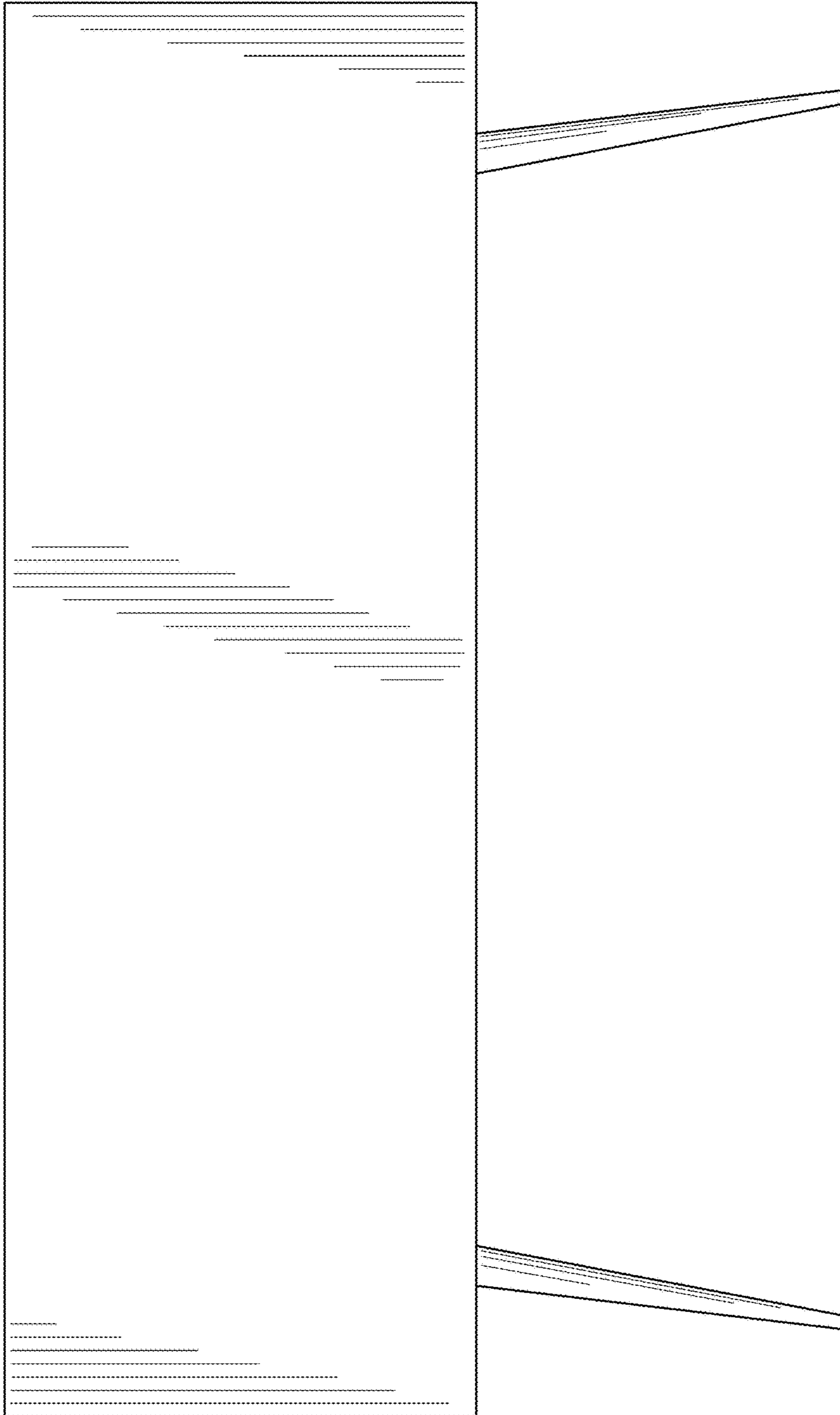

FIG. 3

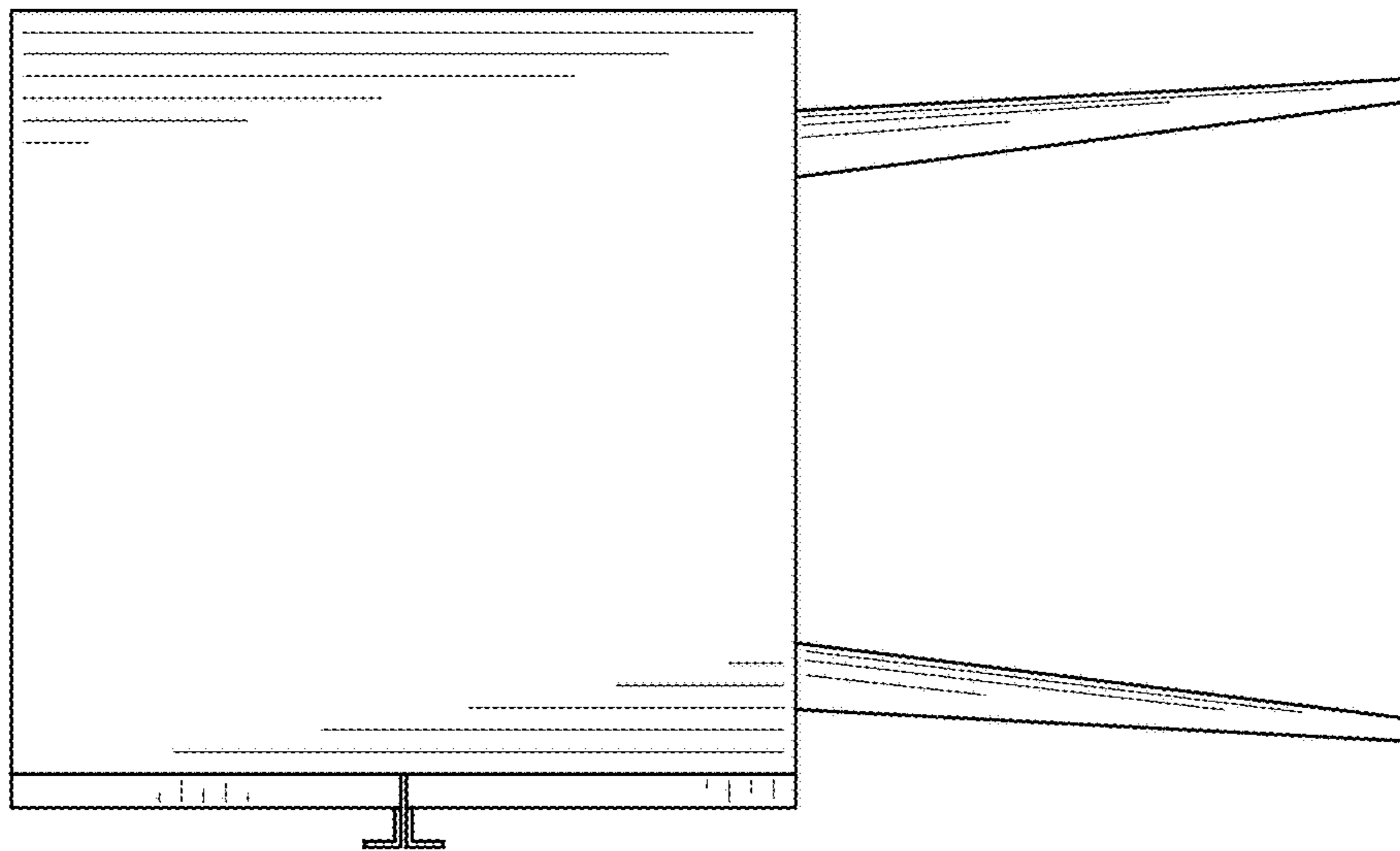

FIG. 4

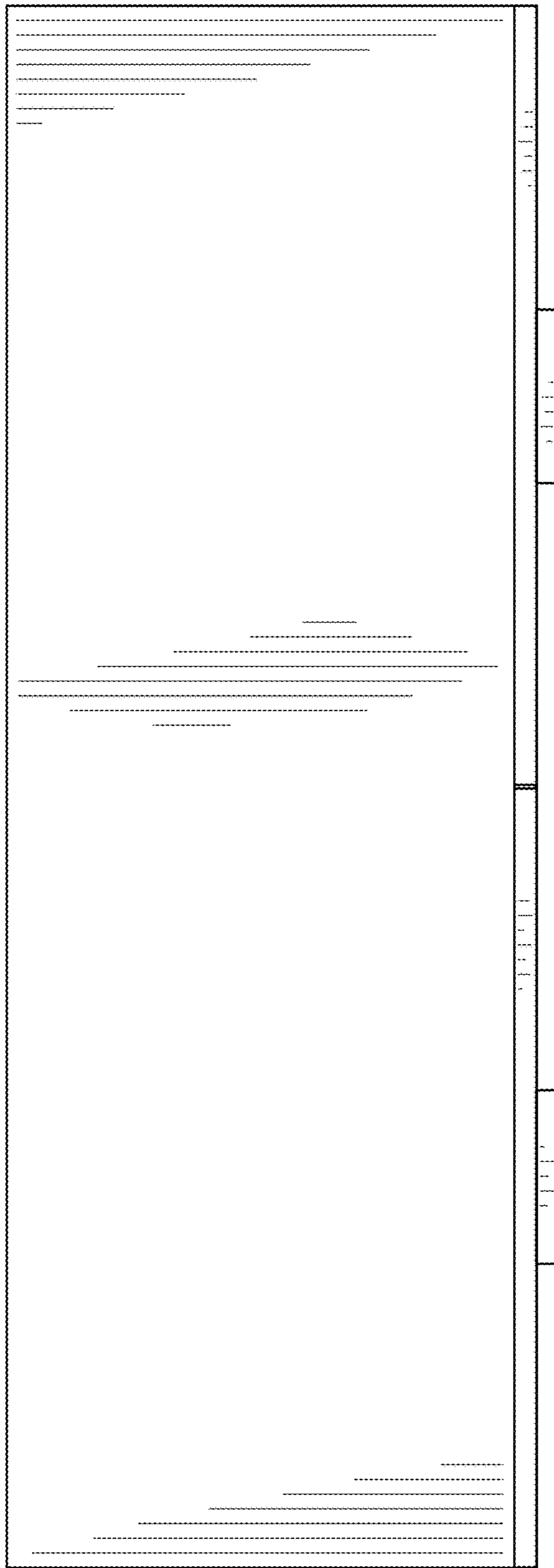

FIG. 5

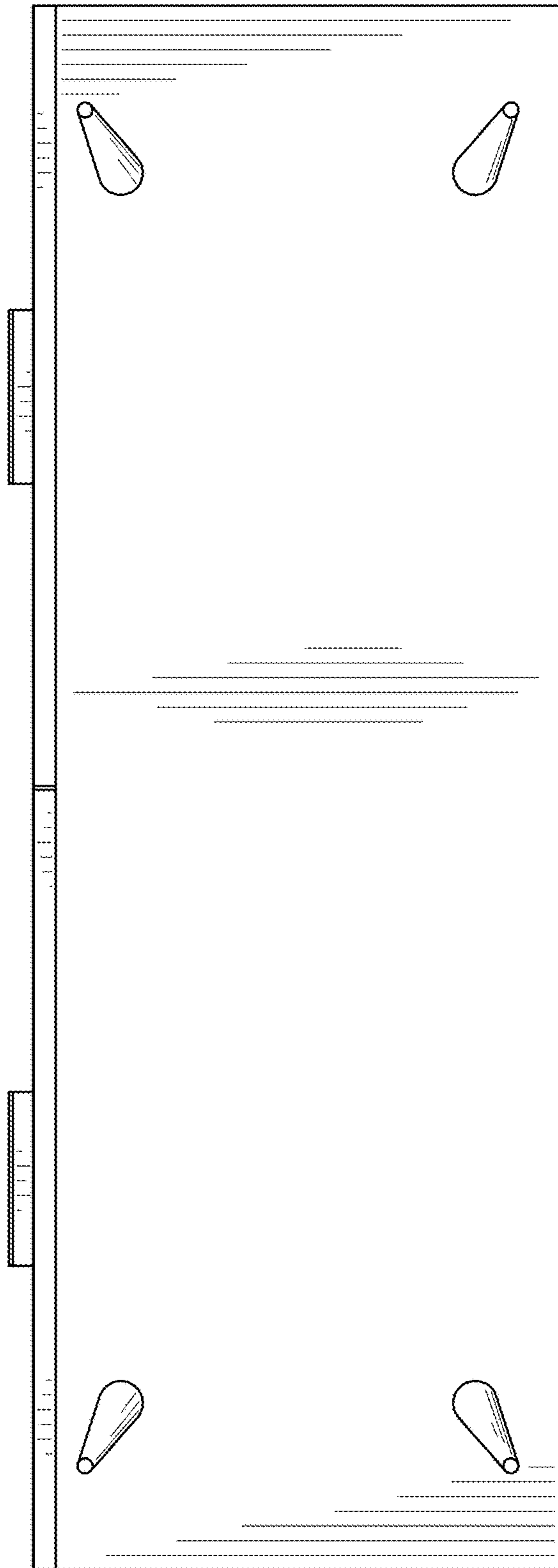

FIG. 6