



US00D815455S

(12) **United States Design Patent**
Kudjawan

(10) **Patent No.:** **US D815,455 S**

(45) **Date of Patent:** **** Apr. 17, 2018**

- (54) **TOOTHBRUSH HOLDER**
- (71) Applicant: **Emmanuel Vilawoe Kudjawan**, Lithia Springs, GA (US)
- (72) Inventor: **Emmanuel Vilawoe Kudjawan**, Lithia Springs, GA (US)
- (**) Term: **15 Years**
- (21) Appl. No.: **29/597,198**
- (22) Filed: **Mar. 15, 2017**
- (51) **LOC (11) Cl.** **23-02**
- (52) **U.S. Cl.**
USPC **D6/534**
- (58) **Field of Classification Search**
USPC D6/534, 524, 526, 527, 528; 211/13.1, 211/66, 70.6, 86.01, 87.01; D11/117, D11/157, 115; D21/586, 628; D1/115; D4/125; 206/208, 228, 209, 209.1, 361, 206/362, 362.1, 362.2, 362.3
CPC .. A47K 1/09; A46B 2200/1066; A46B 17/04; A46B 17/06; A45D 44/18
See application file for complete search history.

- 7,097,050 B1 * 8/2006 McClellan A47K 1/09 211/65
- D543,750 S * 6/2007 Hines D6/534
- 7,246,709 B2 * 7/2007 Kim A47K 1/09 211/65
- D667,247 S * 9/2012 Lawer D6/534
- D667,248 S * 9/2012 Lawer D6/534
- D714,572 S * 10/2014 DeChristofaro D6/528
- 2008/0011235 A1 * 1/2008 Bahnean A01K 5/0114 119/61.5

* cited by examiner

Primary Examiner — David Muller

Assistant Examiner — Nathan Johnston

(74) *Attorney, Agent, or Firm* — Yuri L. Eliezer; Bekiares Eliezer LLP

(57) **CLAIM**

The ornamental design for an toothbrush holder, as shown.

DESCRIPTION

FIG. 1 is a front view of a toothbrush holder showing my new design;
 FIG. 2 is a rear elevation view thereof;
 FIG. 3 is a top plan view thereof;
 FIG. 4 is a bottom plan view thereof;
 FIG. 5 is a left side elevation view thereof, the right side elevation view being a mirror image;
 FIG. 6 is an upper front right perspective view thereof; and,
 FIG. 7 is a lower front right perspective view thereof.
 The broken lines illustrate portions of the toothbrush holder that do not form a part of the claimed design.

1 Claim, 6 Drawing Sheets

(56) **References Cited**

U.S. PATENT DOCUMENTS

- D327,800 S * 7/1992 Hollinger D6/534
- D389,686 S * 1/1998 Drage D10/2
- 5,791,534 A * 8/1998 Davis B44D 3/14 206/362
- D443,158 S * 6/2001 Ng D6/534
- D478,230 S * 8/2003 Dretzka D6/534
- D481,572 S * 11/2003 Dretzka D6/534

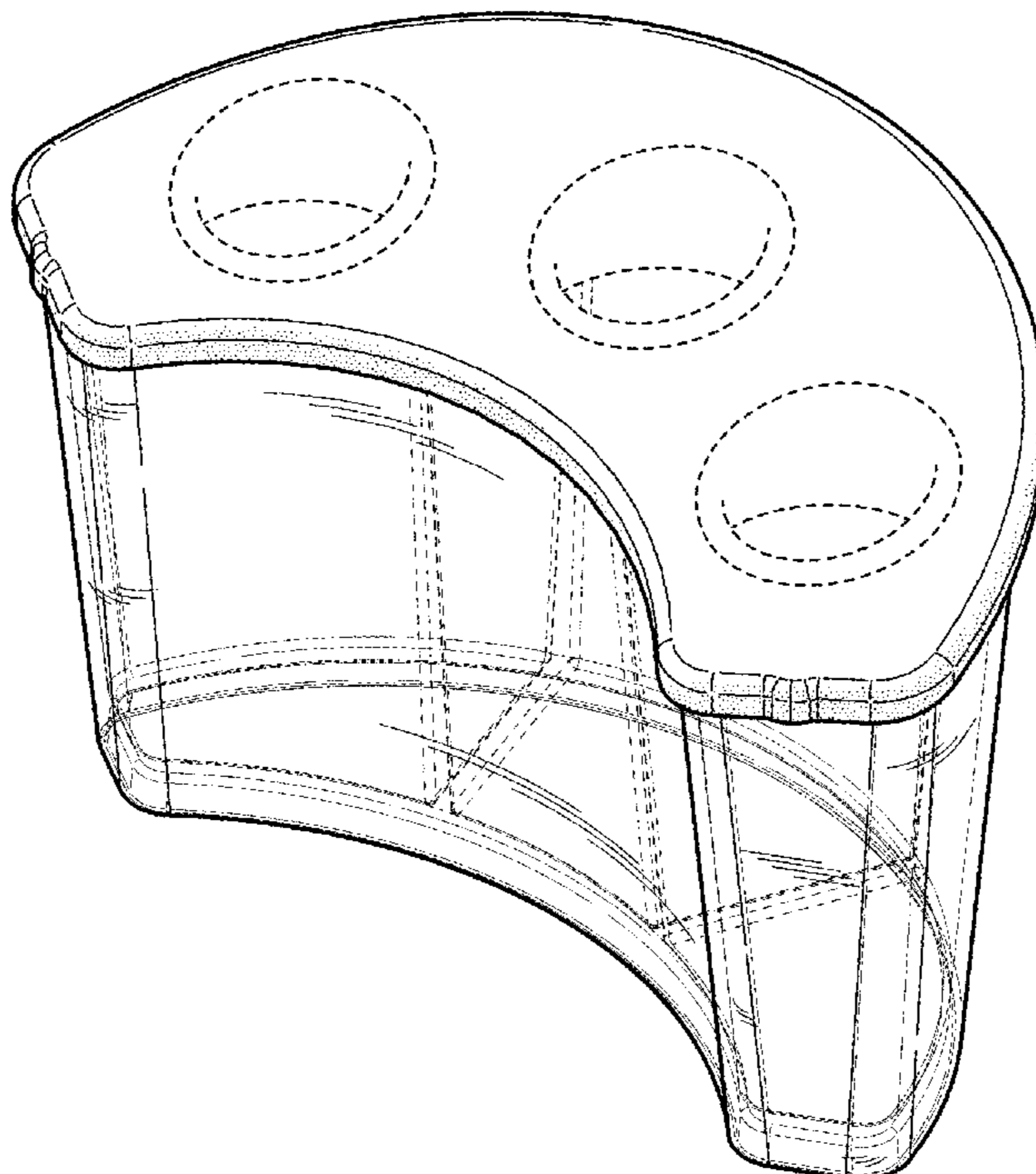

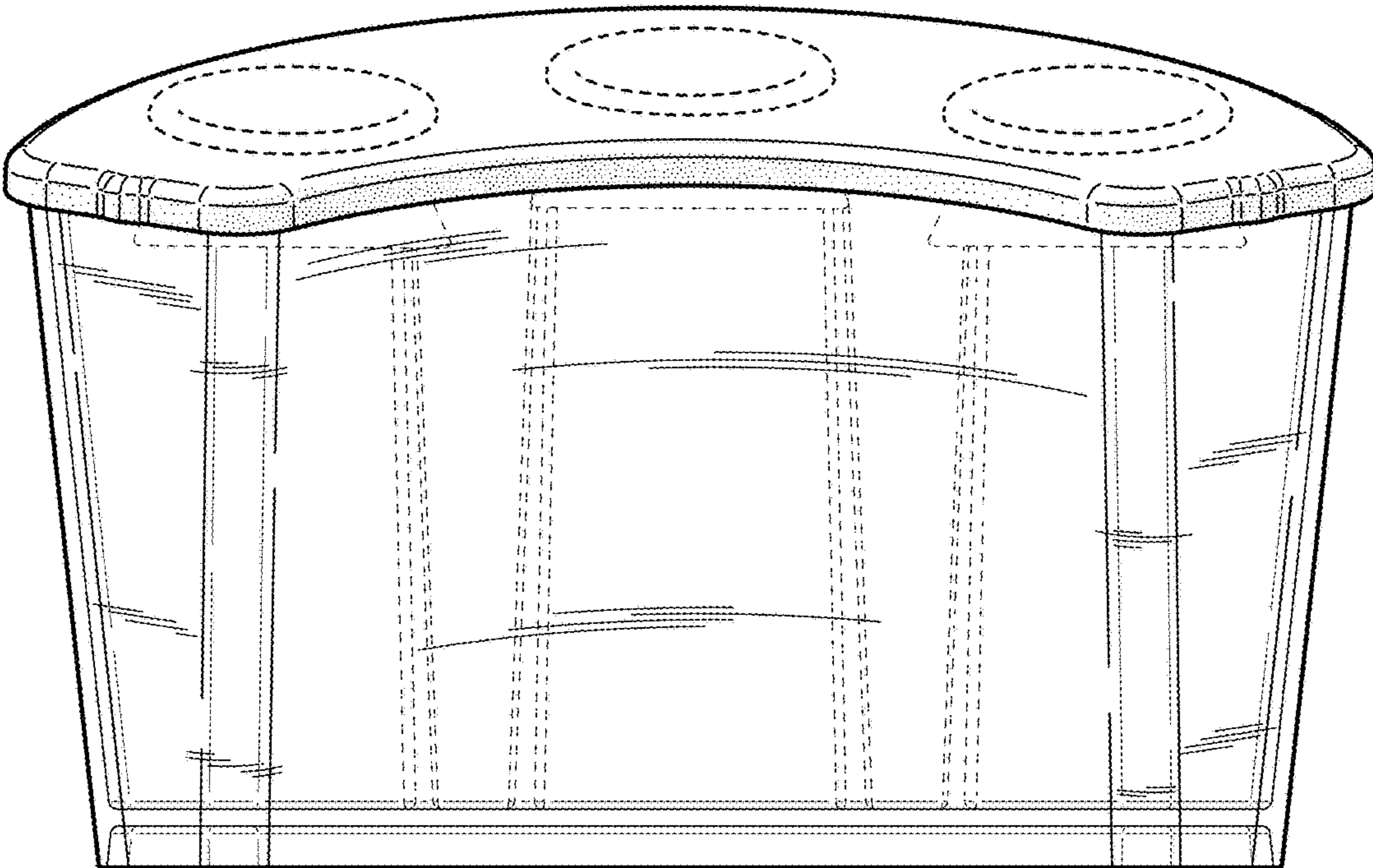

FIG. 1

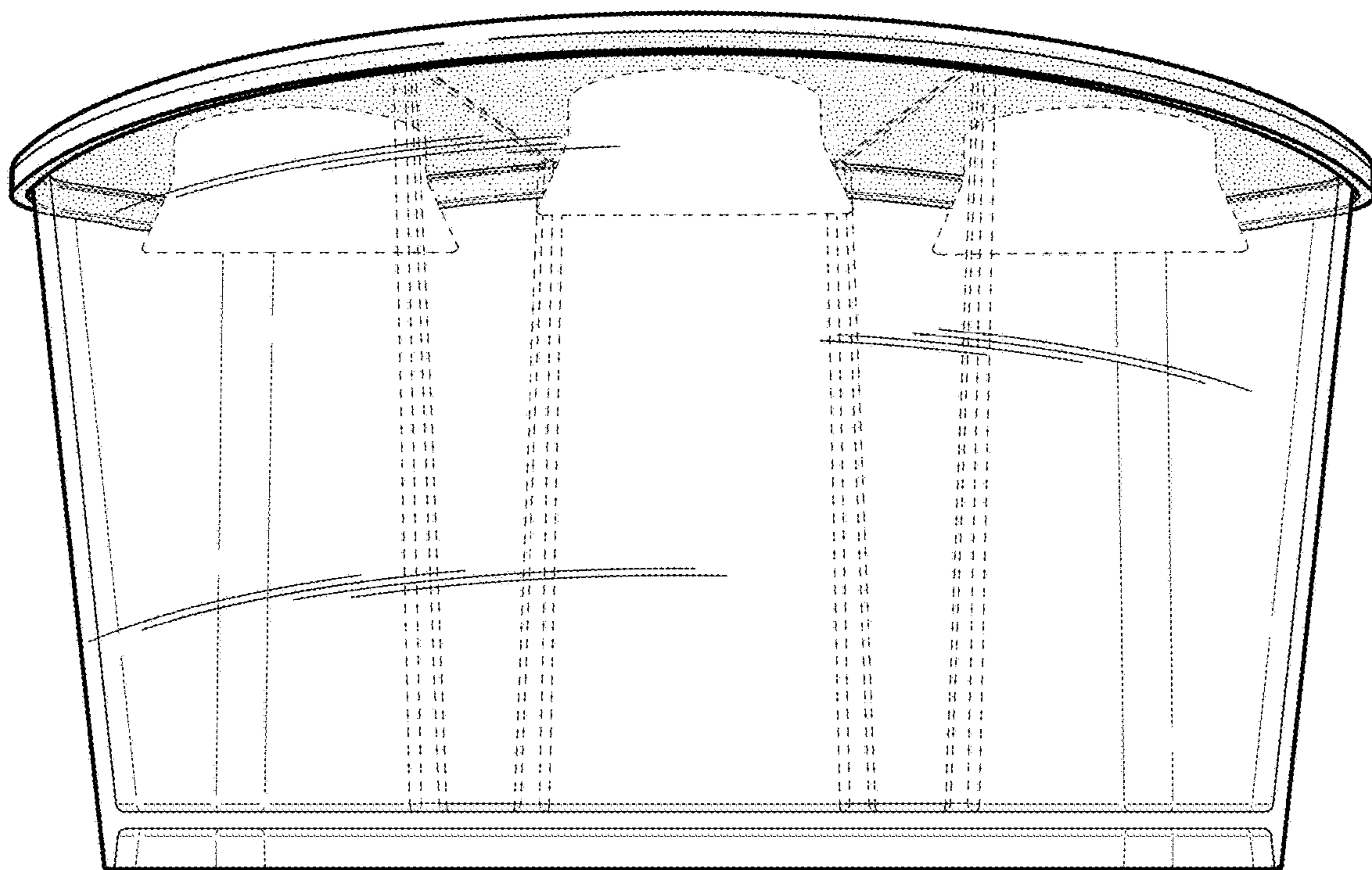

FIG. 2

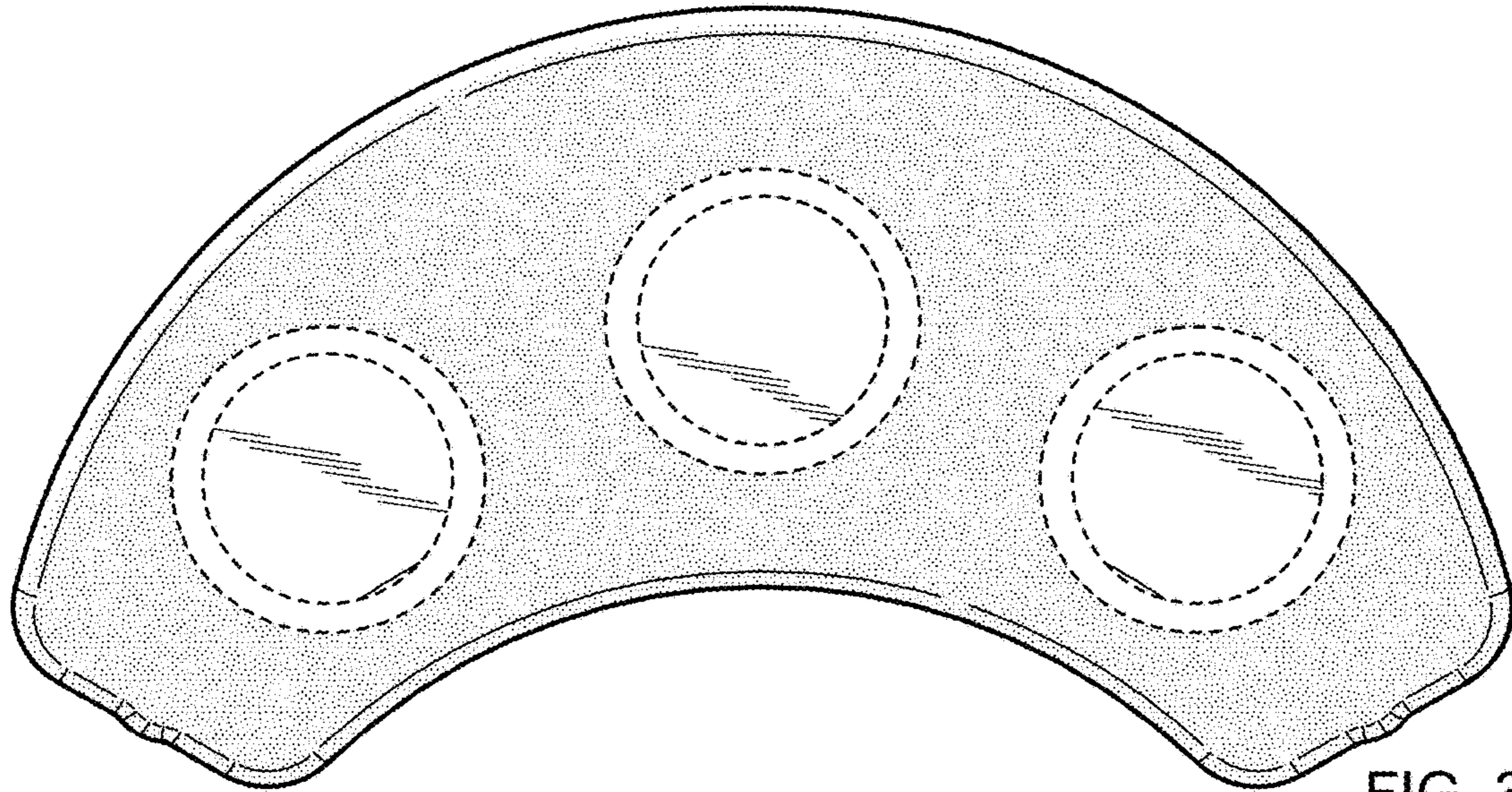

FIG. 3

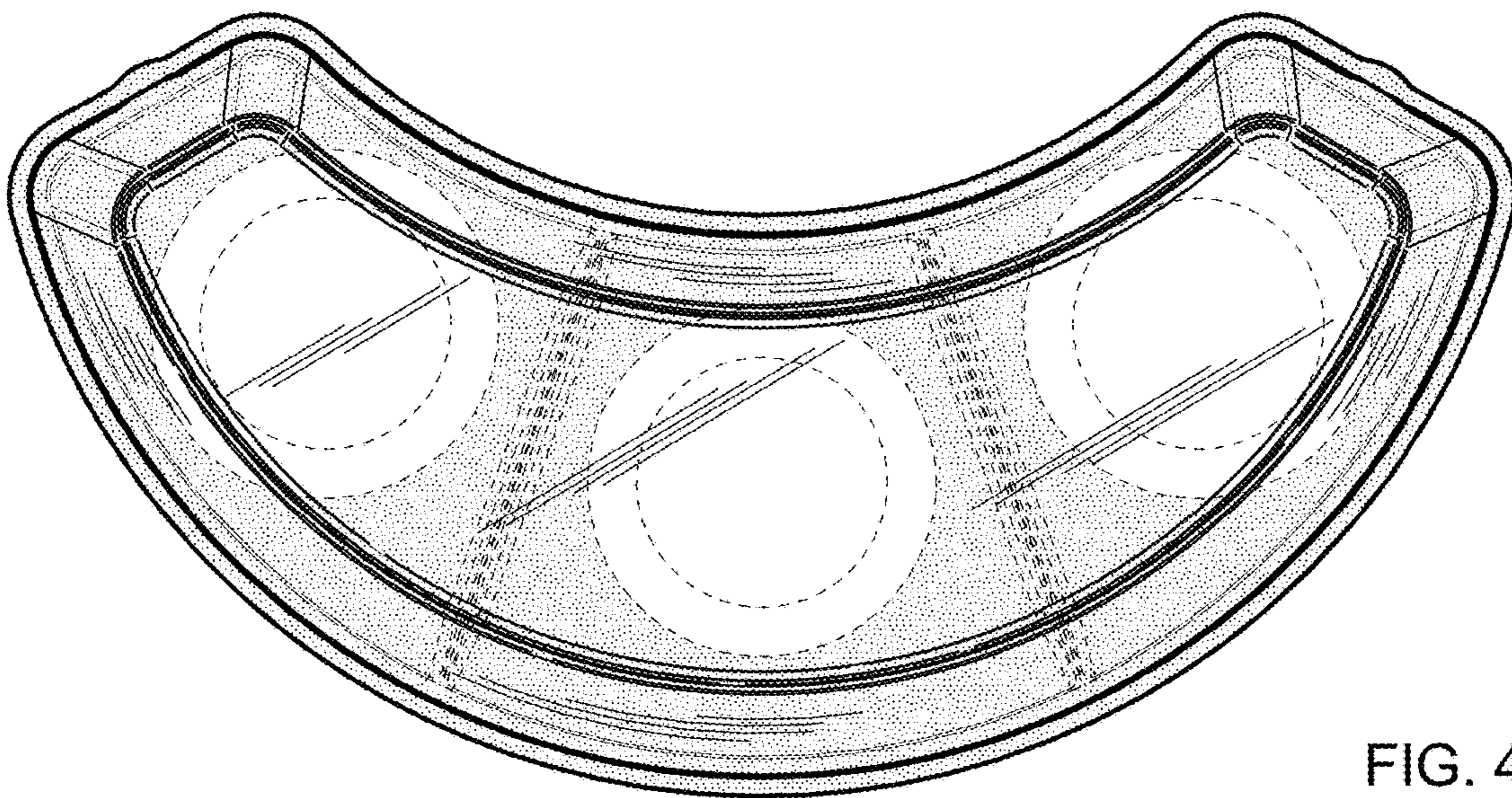

FIG. 4

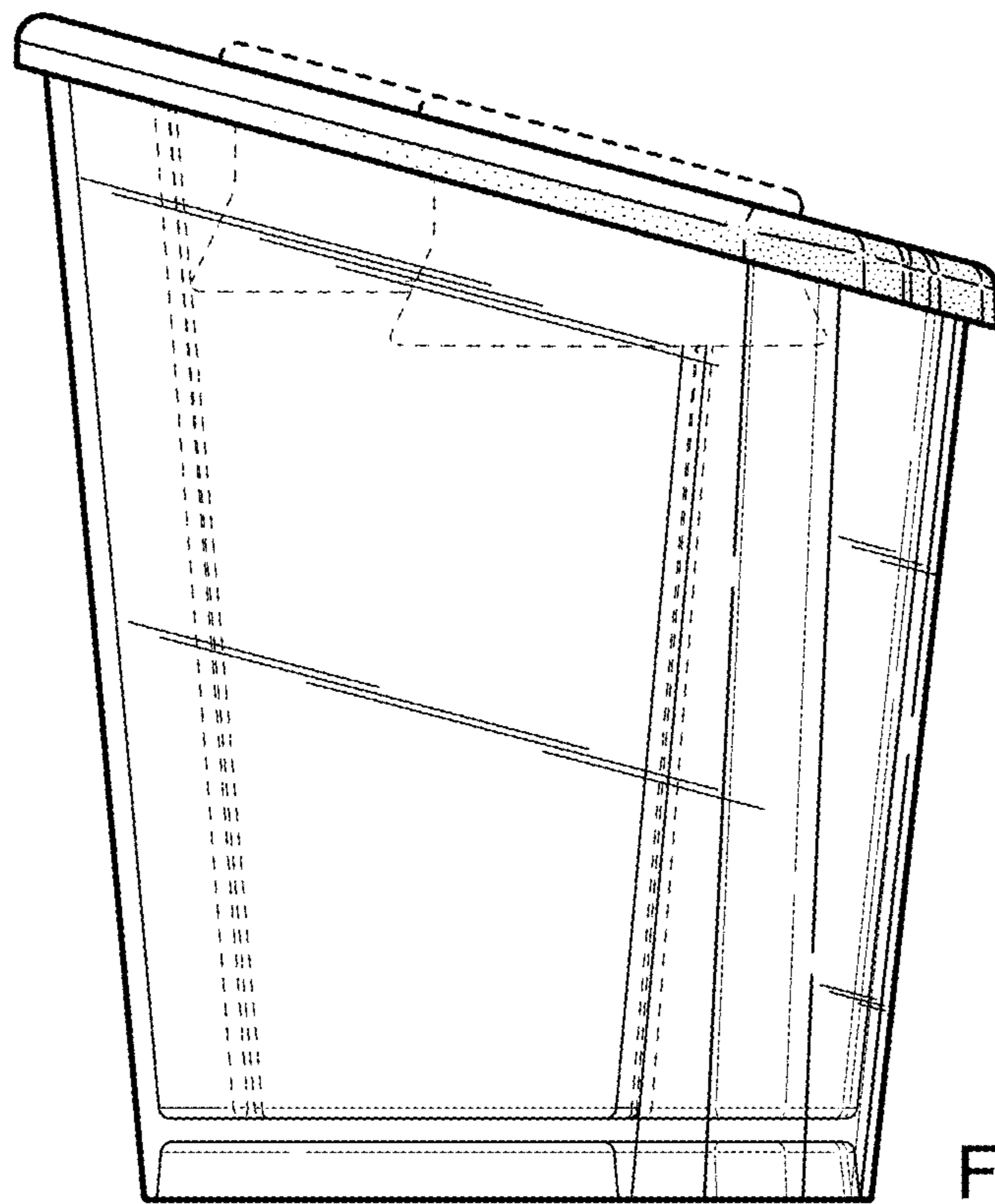

FIG. 5

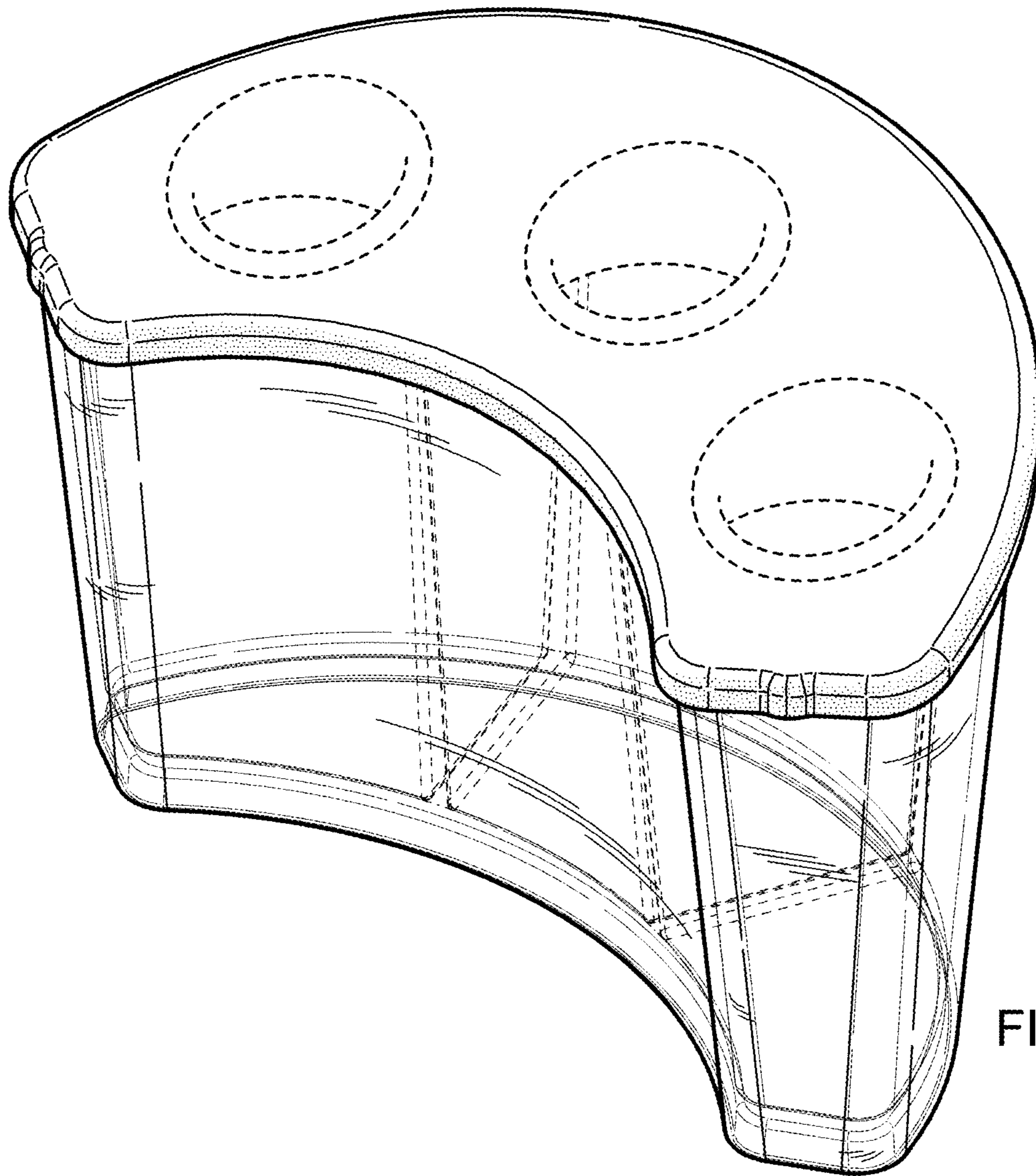

FIG. 6

