



US00D815385S

(12) **United States Design Patent**  
**Kirkland**

(10) **Patent No.:** **US D815,385 S**  
(45) **Date of Patent:** **\*\* Apr. 10, 2018**

- (54) **WAFER SUPPORT RING**
- (71) Applicant: **Entegris, Inc.**, Billerica, MA (US)
- (72) Inventor: **Eric Kirkland**, Colorado Springs, CO (US)
- (73) Assignee: **Entegris, Inc.**, Billerica, MA (US)
- (\*\*) Term: **15 Years**
- (21) Appl. No.: **29/580,872**
- (22) Filed: **Oct. 13, 2016**
- (51) **LOC (11) Cl.** ..... **12-05**
- (52) **U.S. Cl.**  
USPC ..... **D34/29**
- (58) **Field of Classification Search**  
USPC ..... D34/28, 29; 198/851, 853, 825, 890.1,  
198/370.1, 370.04, 782, 722, 771, 866,  
198/367, 790; 193/35 A, 35 C;  
414/744.5, 800; D23/269  
CPC ..... H01L 21/67259; H01L 21/67742; H01L  
21/67288; H02K 5/128  
See application file for complete search history.

D723,239 S \* 2/2015 Raschke ..... D34/29  
 D743,513 S \* 11/2015 Yamagishi ..... D23/269  
 D754,308 S \* 4/2016 Nakagawa ..... D23/269

**FOREIGN PATENT DOCUMENTS**

JP D1362609 S 6/2009  
 JP D1362612 S 6/2009  
 JP D1369017 S 9/2009  
 JP D1397981 S 10/2010  
 JP D1436283 S 3/2012  
 TW D149672 S 10/2012  
 TW D160525 S 5/2014

\* cited by examiner

*Primary Examiner* — Cynthia Ramirez

(57) **CLAIM**

I claim the ornamental design for a wafer support ring, as shown and described.

**DESCRIPTION**

FIG. 1 is a top plan view of a wafer support ring according to an embodiment of the invention.  
 FIG. 2 is a top perspective view of the wafer support ring depicted in FIG. 1.  
 FIG. 3 is a cross-sectional view of the wafer support ring taken at line 3-3 of FIG. 1.  
 FIG. 4 is a cross-sectional view of the wafer support ring taken at line 4-4 of FIG. 1.  
 FIG. 5 is a cross-sectional view of the wafer support ring taken at line 5-5 of FIG. 1.  
 FIG. 6 is a left elevational view of the wafer support ring.  
 FIG. 7 is a front plan view of the wafer support ring.  
 FIG. 8 is a bottom perspective view of the wafer support ring; and,  
 FIG. 9 is a bottom plan view of the wafer support ring.

**1 Claim, 9 Drawing Sheets**

(56) **References Cited**

**U.S. PATENT DOCUMENTS**

3,893,649 A \* 7/1975 Cornell ..... B65B 67/12  
248/101  
4,867,401 A \* 9/1989 Graff ..... B65B 67/12  
248/99  
4,899,967 A \* 2/1990 Johnson ..... B65B 67/12  
248/97  
D457,283 S \* 5/2002 Wayt ..... D34/1  
8,016,542 B2 \* 9/2011 Cox ..... H01L 21/67742  
414/744.5  
D646,764 S \* 10/2011 Rusconi ..... D23/269  
D655,401 S \* 3/2012 Muramatsu ..... D23/269  
D667,601 S \* 9/2012 Fitzpatrick ..... D34/6

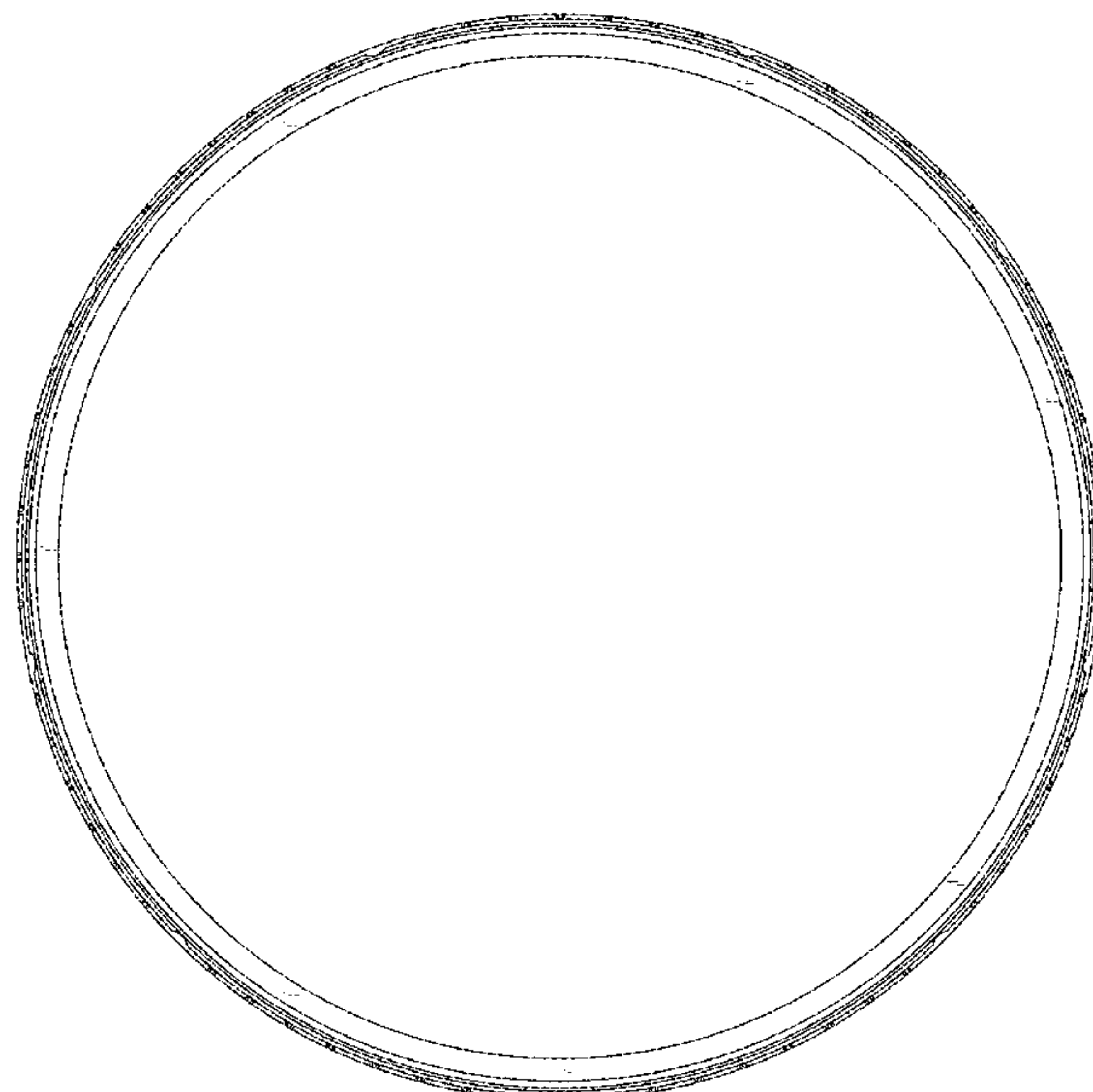

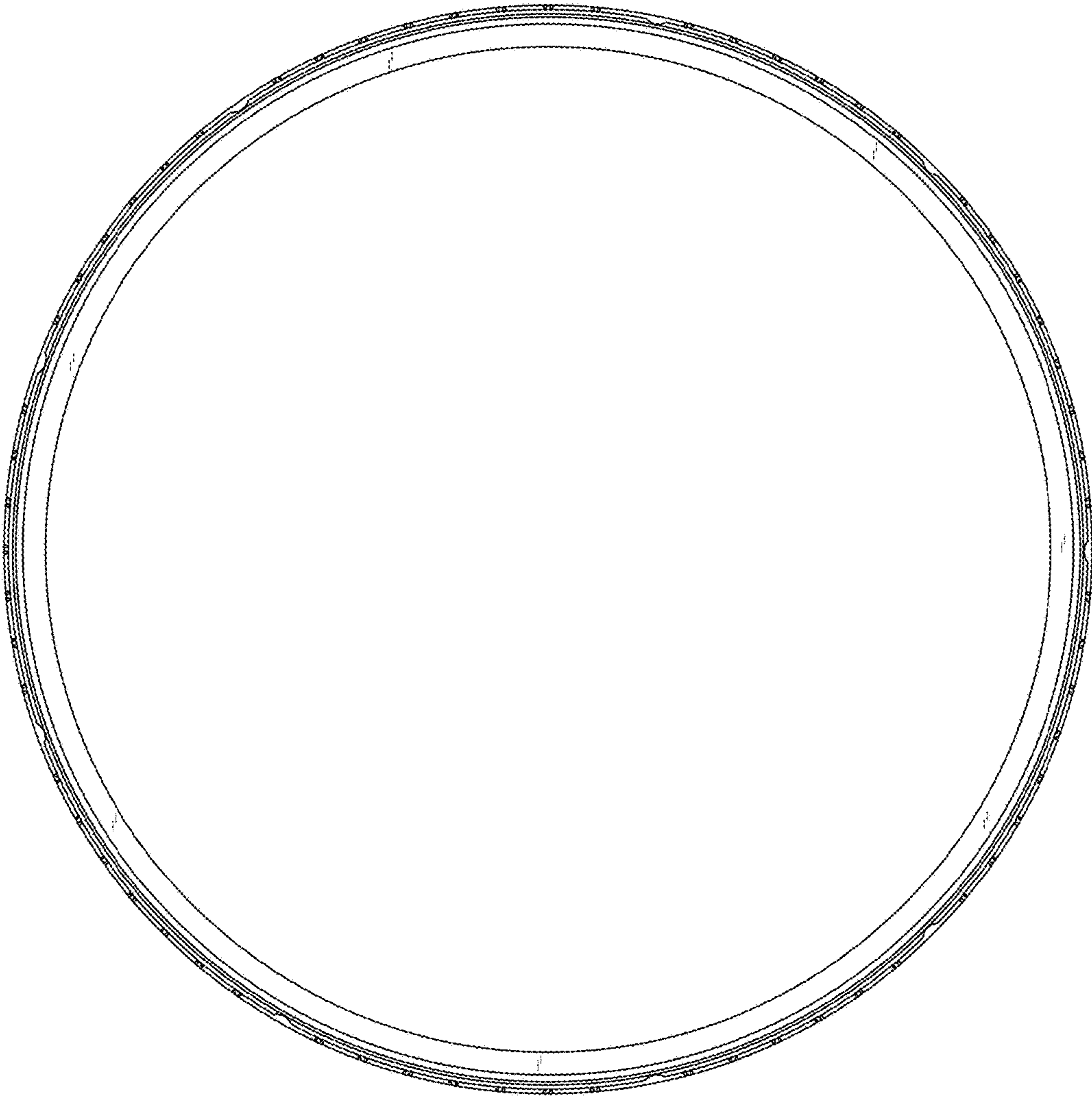

Fig. 1

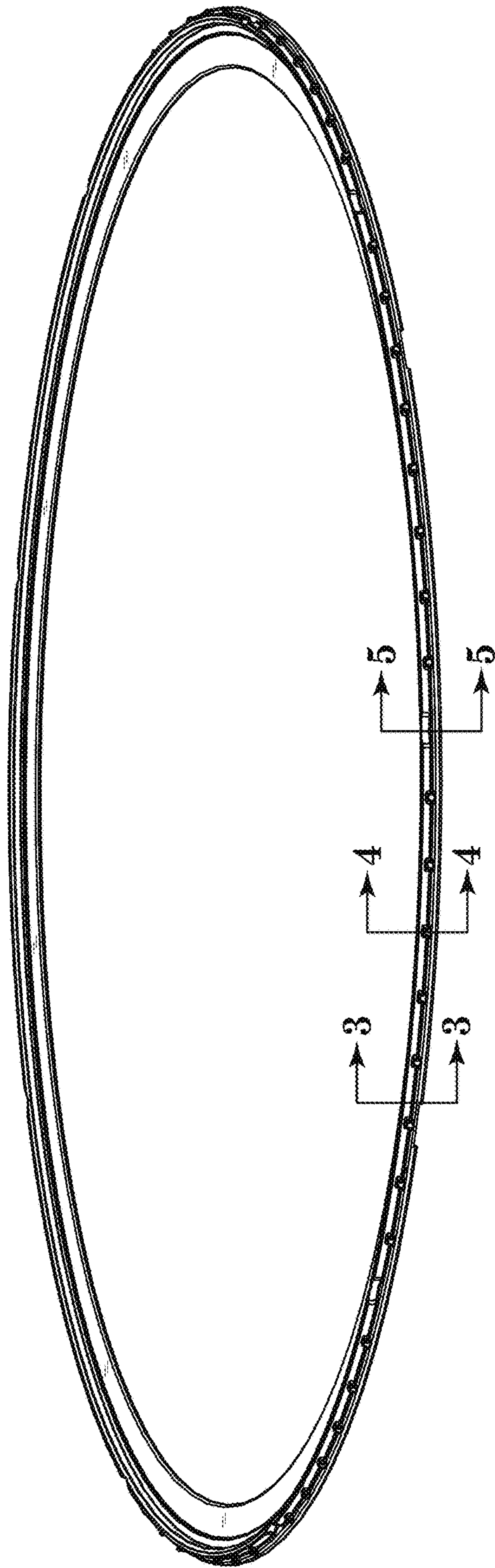

Fig. 2

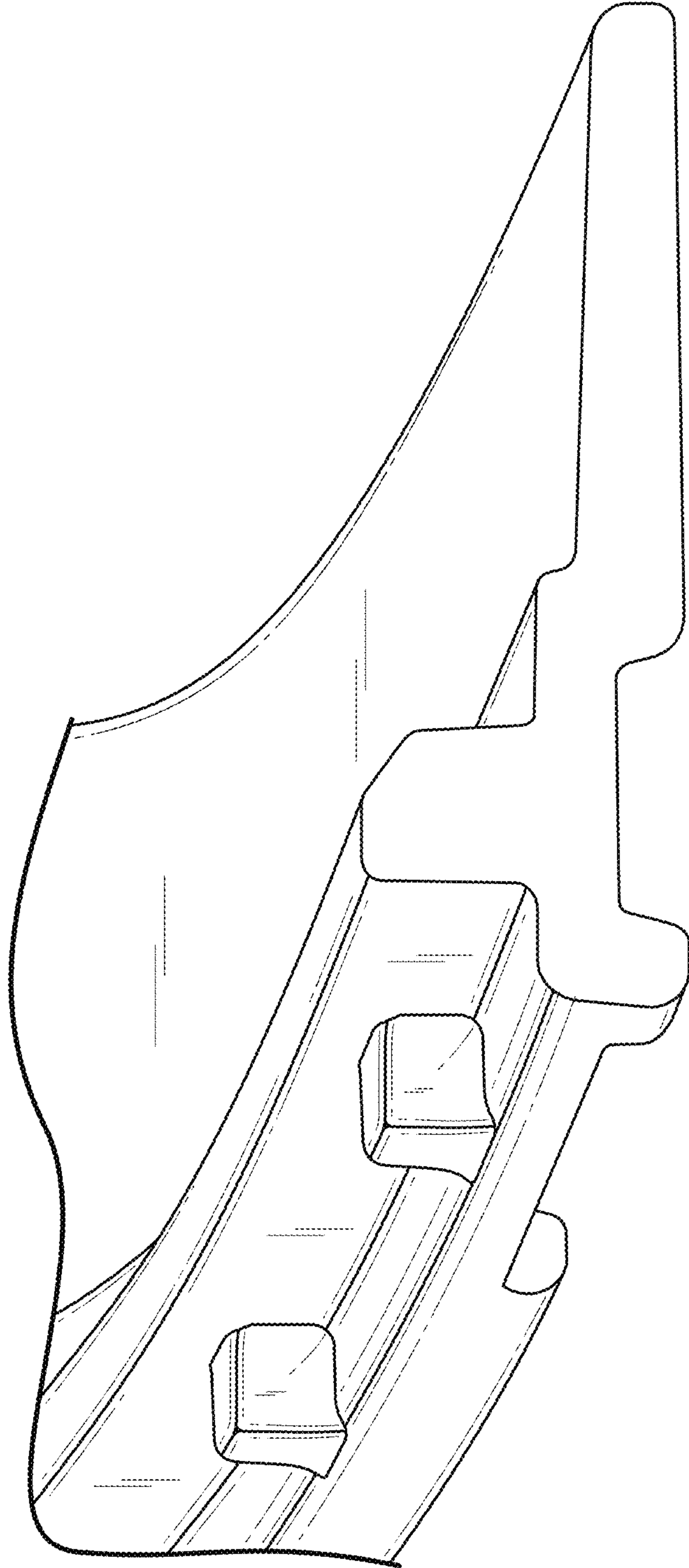

Fig. 3





Fig. 4

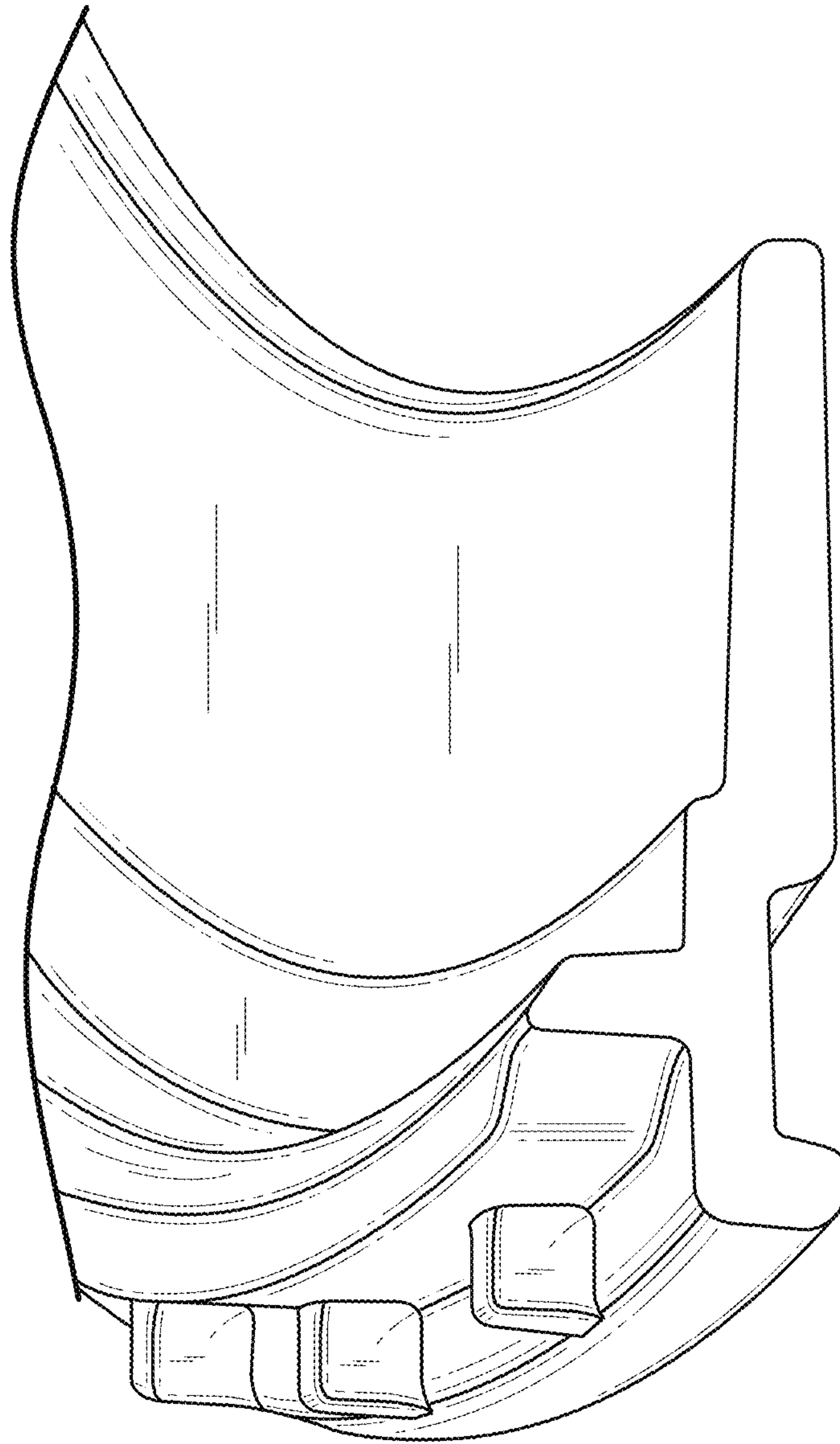

Fig. 5

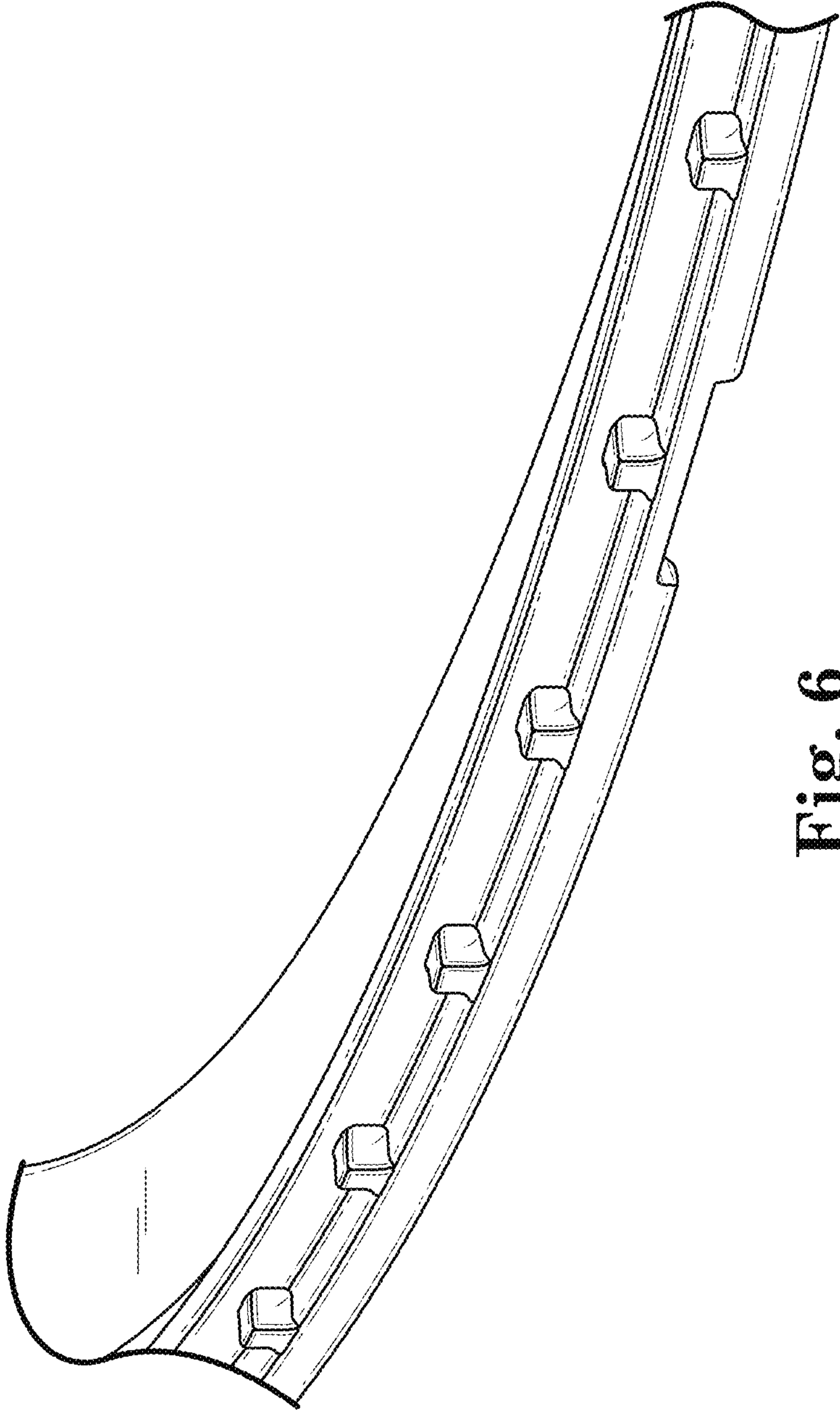

Fig. 6

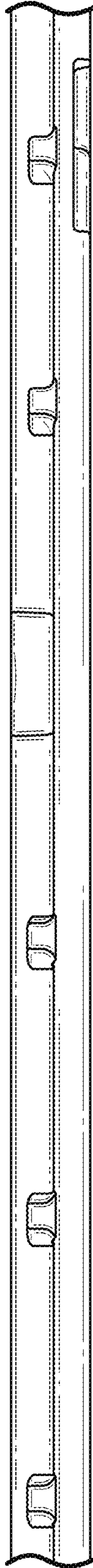

Fig. 7



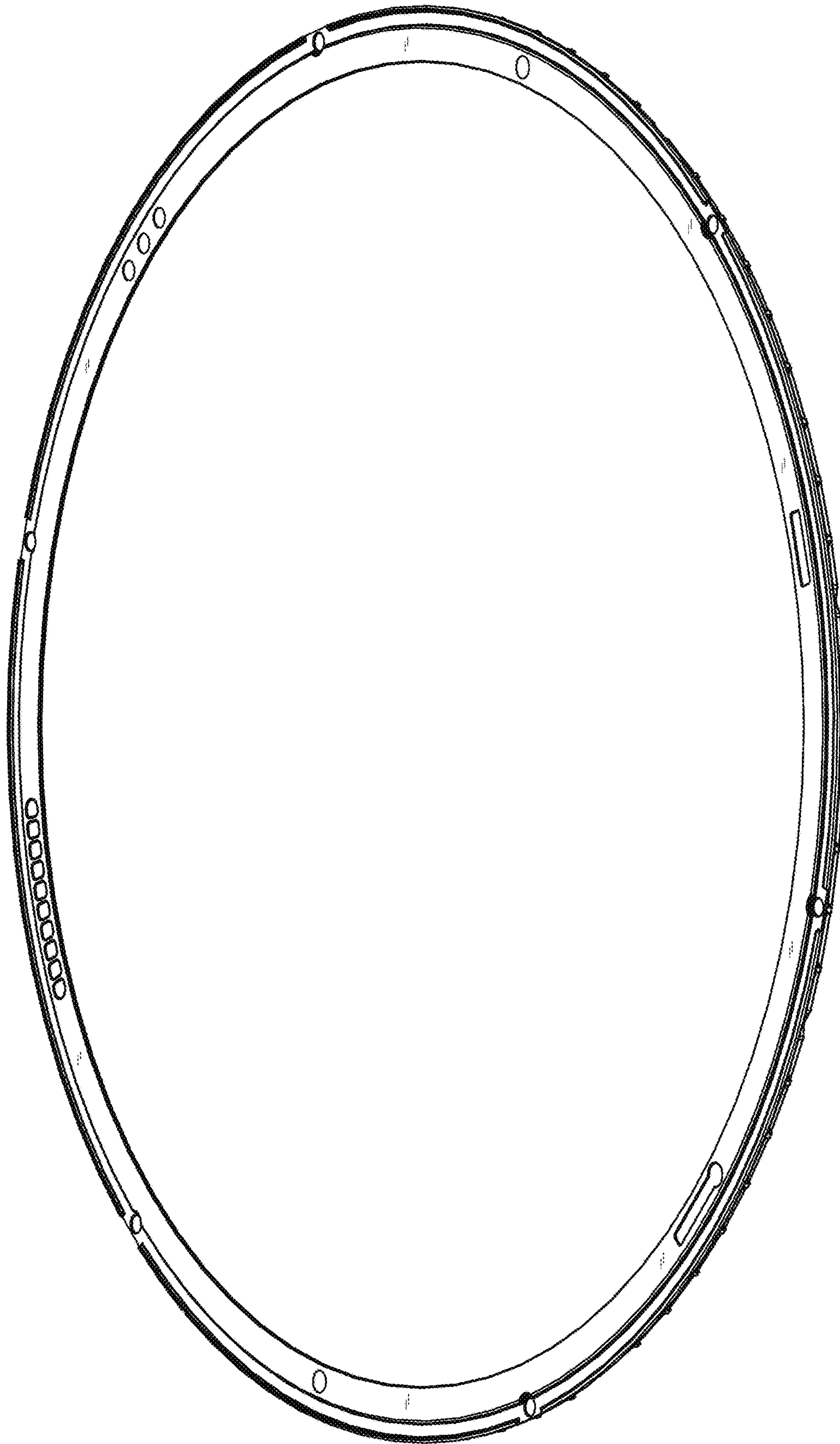

Fig. 8

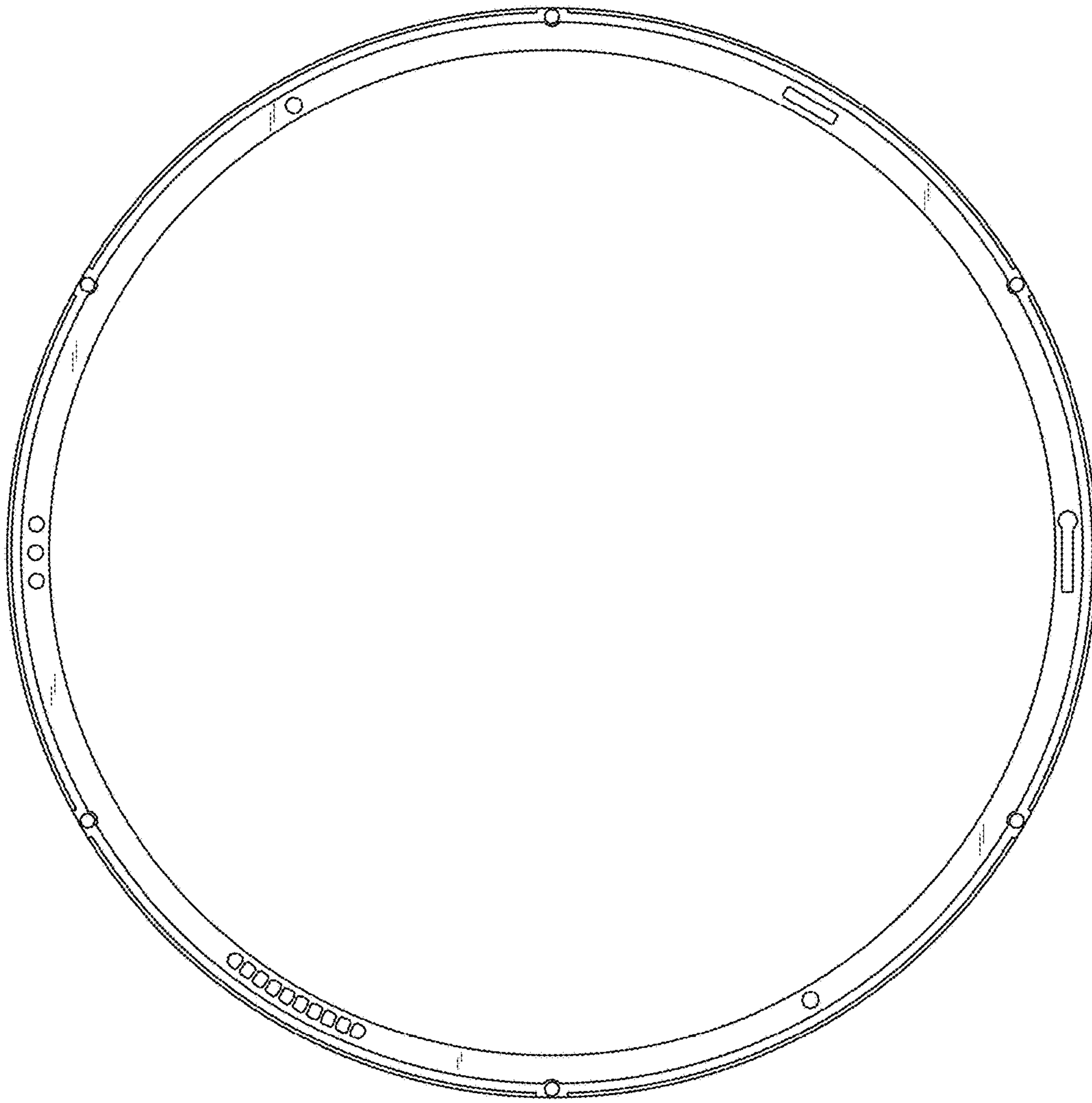

Fig. 9