



US00D815369S

(12) **United States Design Patent**  
**Byrne et al.**

(10) **Patent No.:** **US D815,369 S**  
(45) **Date of Patent:** **\*\* Apr. 10, 2018**

(54) **ROPE SNAKE PET TOY WITH FABRIC HEAD**

D657,234 S \* 4/2012 Herman ..... D8/382  
D697,985 S \* 1/2014 Terry ..... D21/615  
D728,171 S \* 4/2015 Byrne ..... D30/160

(71) Applicant: **C.B. Worldwide, Inc.**, Mammoth Lakes, CA (US)

\* cited by examiner

(72) Inventors: **Charles A. Byrne**, Mammoth Lakes, CA (US); **Jose Luis Andreu**, El Paso, TX (US)

*Primary Examiner* — Cathy Anne MacCormac  
(74) *Attorney, Agent, or Firm* — Hackler Daghighian Martino & Novak

(73) Assignee: **C.B. Worldwide, Inc.**, Mammoth Lakes, CA (US)

(\*\*) Term: **15 Years**

(21) Appl. No.: **29/535,834**

(22) Filed: **Aug. 11, 2015**

(51) **LOC (11) Cl.** ..... **30-99**

(52) **U.S. Cl.**  
USPC ..... **D30/160; D21/657**

(58) **Field of Classification Search**  
USPC ..... D30/160; D24/211–212; D21/405–406,  
D21/662, 684, 560, 657; 119/706  
CPC .. A01K 15/024; A01K 15/025; A01K 15/026;  
A01K 15/027  
See application file for complete search history.

(56) **References Cited**

U.S. PATENT DOCUMENTS

D469,481 S \* 1/2003 Lewis ..... D21/657  
D624,974 S \* 10/2010 Taylor ..... D21/657

(57) **CLAIM**

The ornamental design for a rope snake pet toy with fabric head, as shown and described.

**DESCRIPTION**

FIG. 1 is a perspective view of a rope snake pet toy with fabric head embodying my new design;  
FIG. 2 is an enlarged front elevation view of FIG. 1;  
FIG. 3 is an enlarged rear elevation view of FIG. 1;  
FIG. 4 is a left side elevation view of FIG. 1;  
FIG. 5 is a right side elevation view of FIG. 1;  
FIG. 6 is a top plan view of FIG. 1; and,  
FIG. 7 is a bottom plan view of FIG. 1.  
The broken lines depict environmental subject matter and form no part of the claimed design.

**1 Claim, 3 Drawing Sheets**

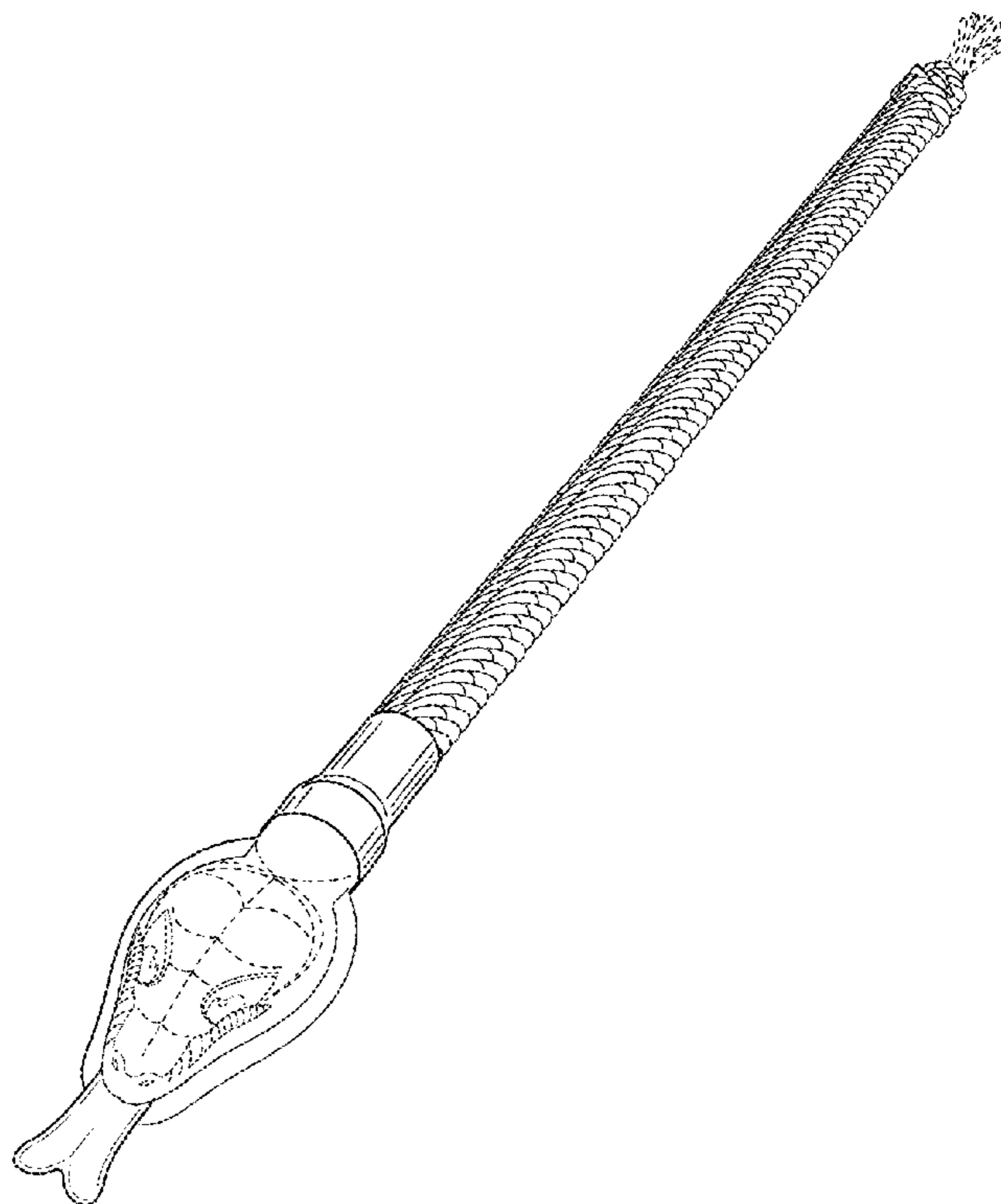

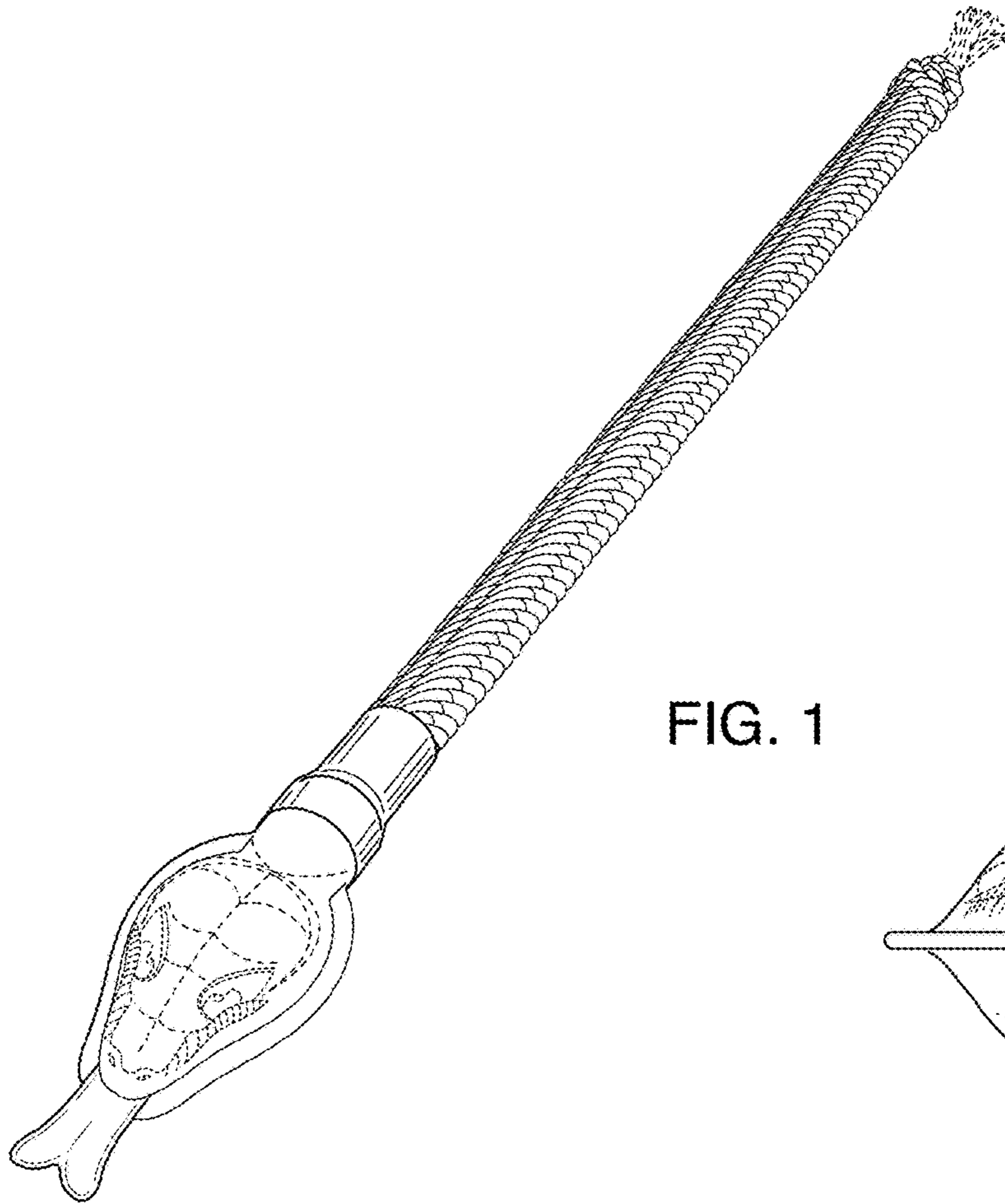

FIG. 1

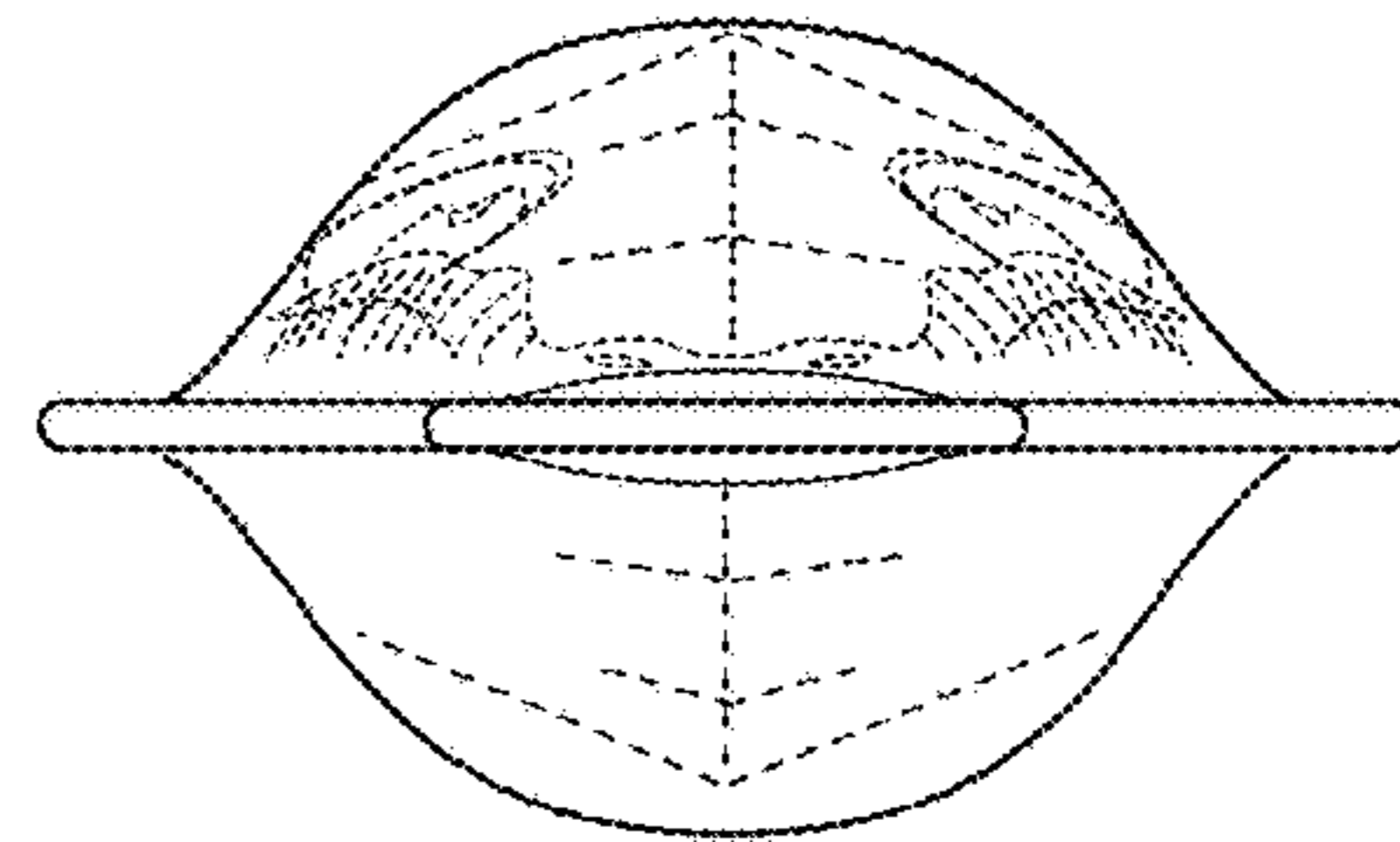

FIG. 2

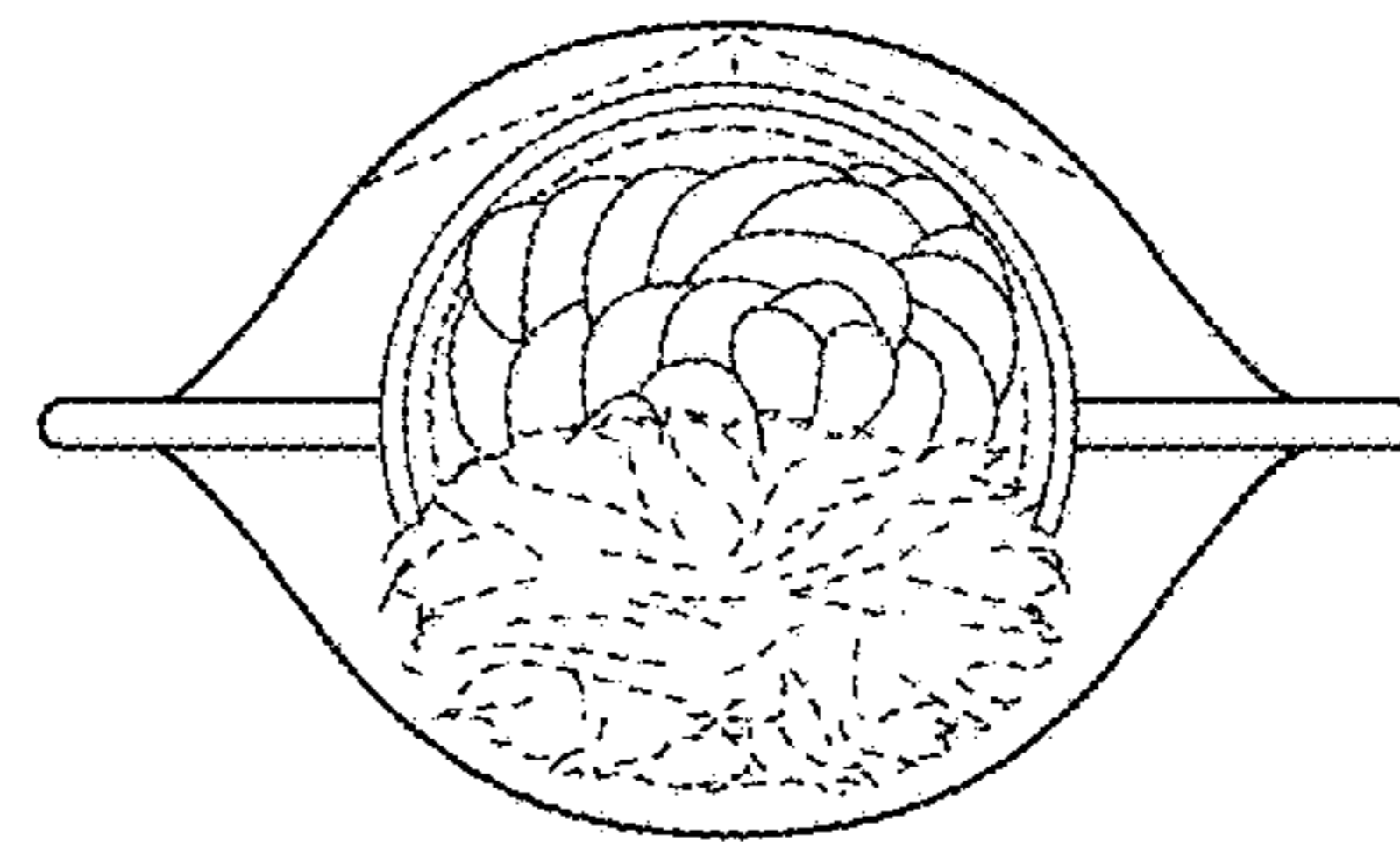

FIG. 3

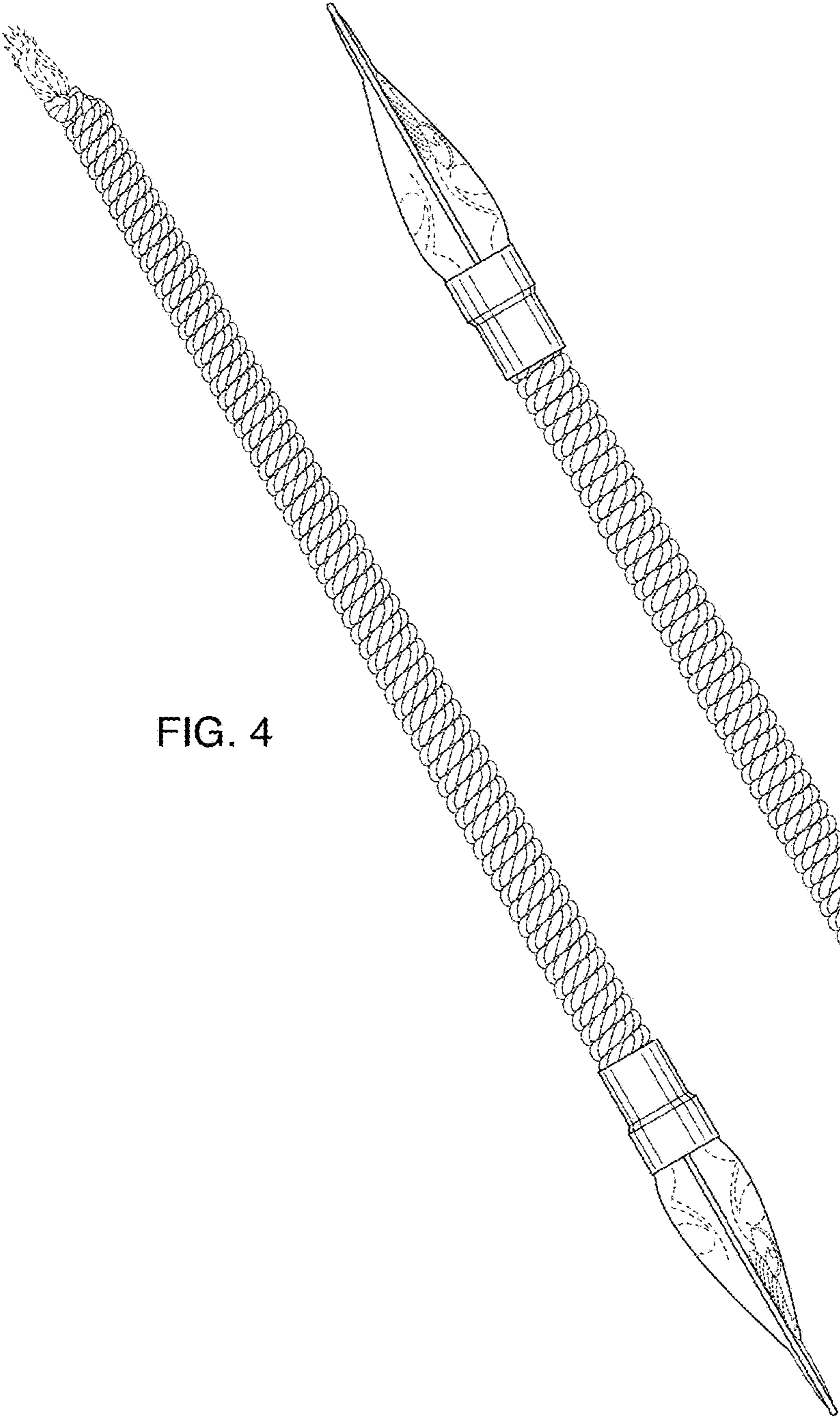

FIG. 4

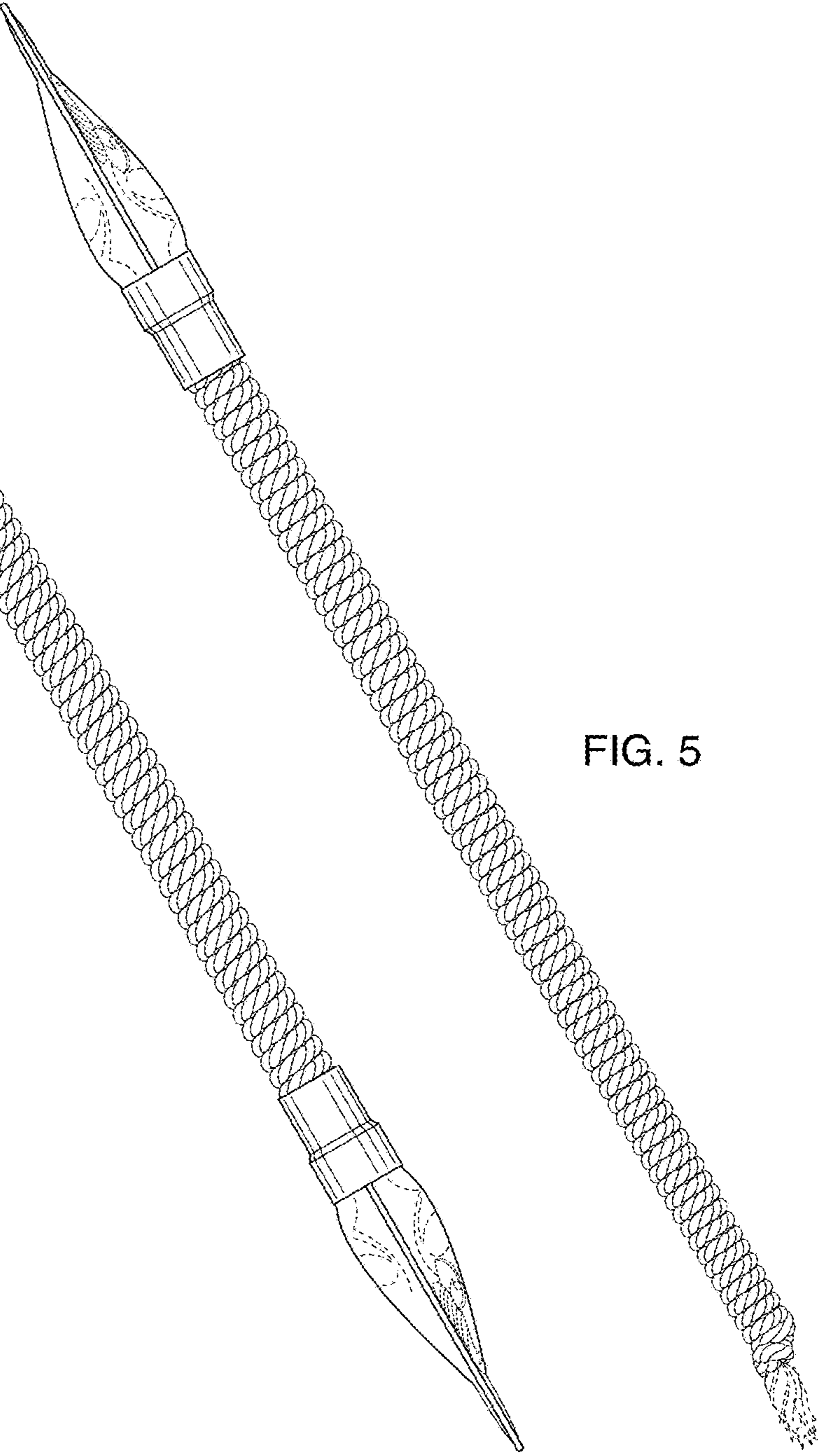

FIG. 5

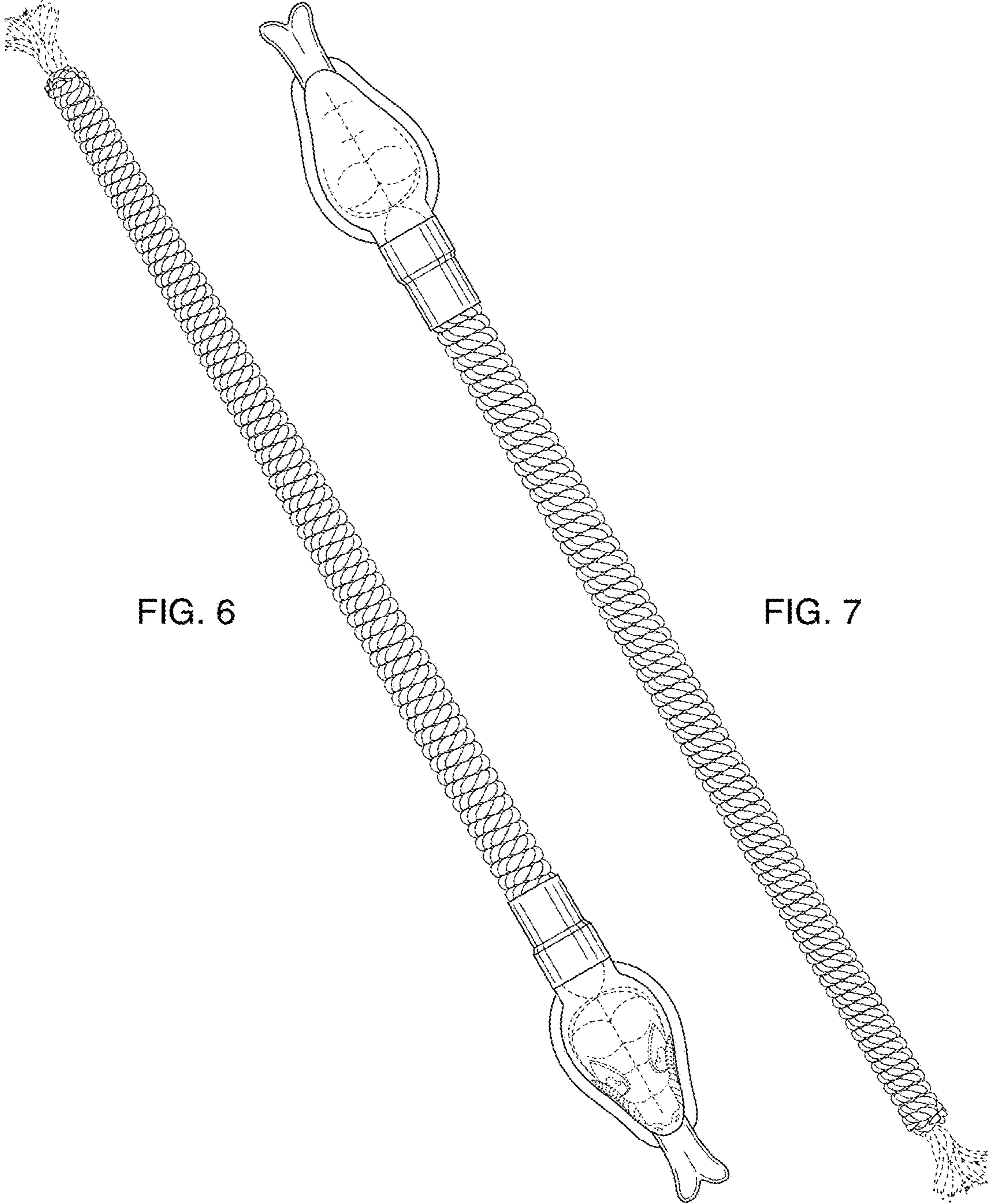

FIG. 6

FIG. 7