



US00D815368S

(12) **United States Design Patent** (10) **Patent No.:** **US D815,368 S**  
**Fei** (45) **Date of Patent:** **\*\* Apr. 10, 2018**

(54) **GLOVE FOR MASSAGING PETS**

5/04; A47K 7/02; A61H 7/00; A61H 7/001; A61H 7/002; A61H 7/003

(71) Applicant: **Weibing Fei**, Wuxi (CN)

See application file for complete search history.

(72) Inventor: **Weibing Fei**, Wuxi (CN)

(56) **References Cited**

(73) Assignee: **Wuxi Fangqian Plastic Working Glove Co., Ltd.**, Wuxi, Jiangsu (CN)

U.S. PATENT DOCUMENTS

(\*\*) Term: **15 Years**

(21) Appl. No.: **29/583,054**

(22) Filed: **Nov. 2, 2016**

(51) **LOC (11) Cl.** ..... **30-99**

(52) **U.S. Cl.**  
USPC ..... **D30/158**

(58) **Field of Classification Search**  
USPC ..... D30/158; 119/600, 611, 612, 625, 632, 119/664, 614, 650, 626, 627; D24/200; D29/117.1, 117.2, 113, 116.2, 116.6, 123, D29/190, 118; D28/63; D32/40, 35, 43; D2/610, 613-623, 902, 951, 159, D2/161.3-161.8; 601/80, 74, 134, 155, 601/137; 15/160, 227, 104.94, 209.1, 15/210.1, 237, 246.2, 186, 188, 167.1; 2/160, 161.1, 159, 161.3, 161.6, 16, 2/161.8, 163, 20, 168, 167, 167.1; D4/103; 606/201, 204; 139/396; 473/450, 205; 434/248; 401/7, 186, 201; 428/141, 152, 156, 167, 187; 36/28, 36/59 C, 59 R  
CPC .... A01K 13/00; A01K 13/001; A01K 13/003; A01K 13/004; A41D 19/00; A41D 19/0058; A41D 19/0086; A41D 19/0082; A41D 19/0024; A41D 19/0051; A41D 19/0079; A41D 19/01558; A41D 19/01576; A41D 19/01588; A41D 2400/00; A41D 2400/32; A41D 2400/322; A41D 2400/324; A41D 2400/38; A46B

168,836 A *	10/1875	Hall	.....	A47J 17/02	2/161.8
1,161,719 A *	11/1915	Norton	.....	15/104.94	
D54,333 S *	12/1919	Reynolds	.....	D29/117.2	
1,346,683 A *	7/1920	Reynolds	.....	A41D 19/0065	15/227
1,438,485 A *	12/1922	Goldberg	.....	A61H 7/003	15/104.001
1,530,327 A *	3/1925	Redlick	.....	A47L 1/08	15/227
1,533,732 A *	4/1925	Frost	.....	A47L 13/18	239/529
1,559,114 A *	10/1925	Maranville	.....	A41D 19/01558	15/227
1,885,572 A *	11/1932	Wood	.....	A61H 7/00	15/188
2,187,430 A *	1/1940	Olmsted	.....	A41D 19/0055	15/227

(Continued)

*Primary Examiner* — Susan Moon Lee

(57) **CLAIM**

I claim the ornamental design for a glove for massaging pets, as shown and described.

**DESCRIPTION**

FIG. 1 is a front view of the glove for massaging pets in accordance with my new design;  
FIG. 2 is a back view thereof;  
FIG. 3 is a left side view thereof;  
FIG. 4 is a right side view thereof;  
FIG. 5 is a top plan view thereof;  
FIG. 6 is a bottom plan view thereof; and,  
FIG. 7 is a perspective view thereof.

**1 Claim, 7 Drawing Sheets**

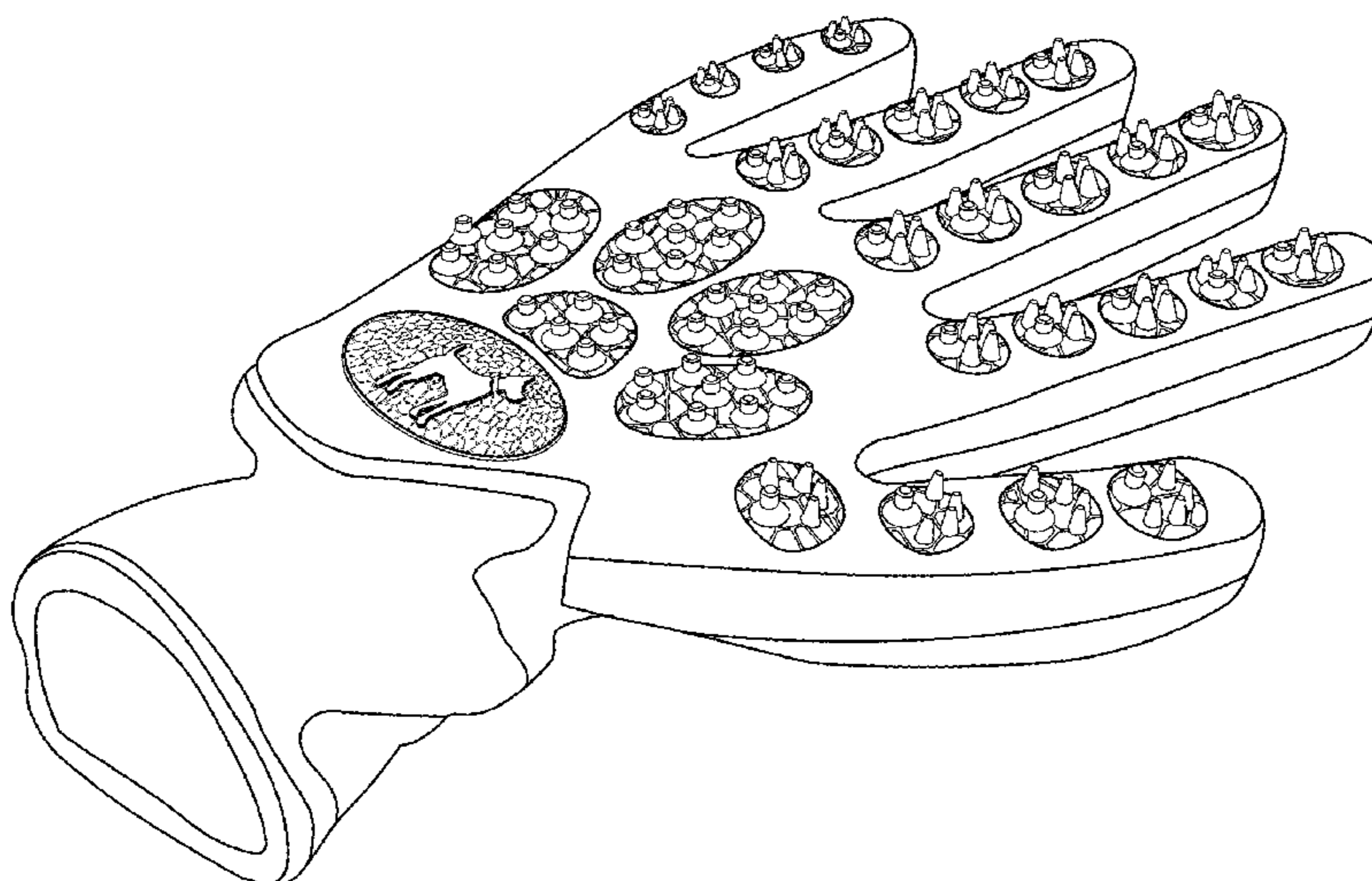



(56)

**References Cited**

U.S. PATENT DOCUMENTS

2014/0208481 A1\* 7/2014 Champagne ..... A61B 42/10  
2/161.7  
2015/0181955 A1\* 7/2015 Hughes ..... A41D 19/01523  
2/16  
2016/0073611 A1\* 3/2016 Hightower ..... A01K 13/001  
119/603  
2016/0367108 A1\* 12/2016 Golub ..... A41D 19/0006  
2017/0142931 A1\* 5/2017 Michaelson ..... A01K 13/001

\* cited by examiner

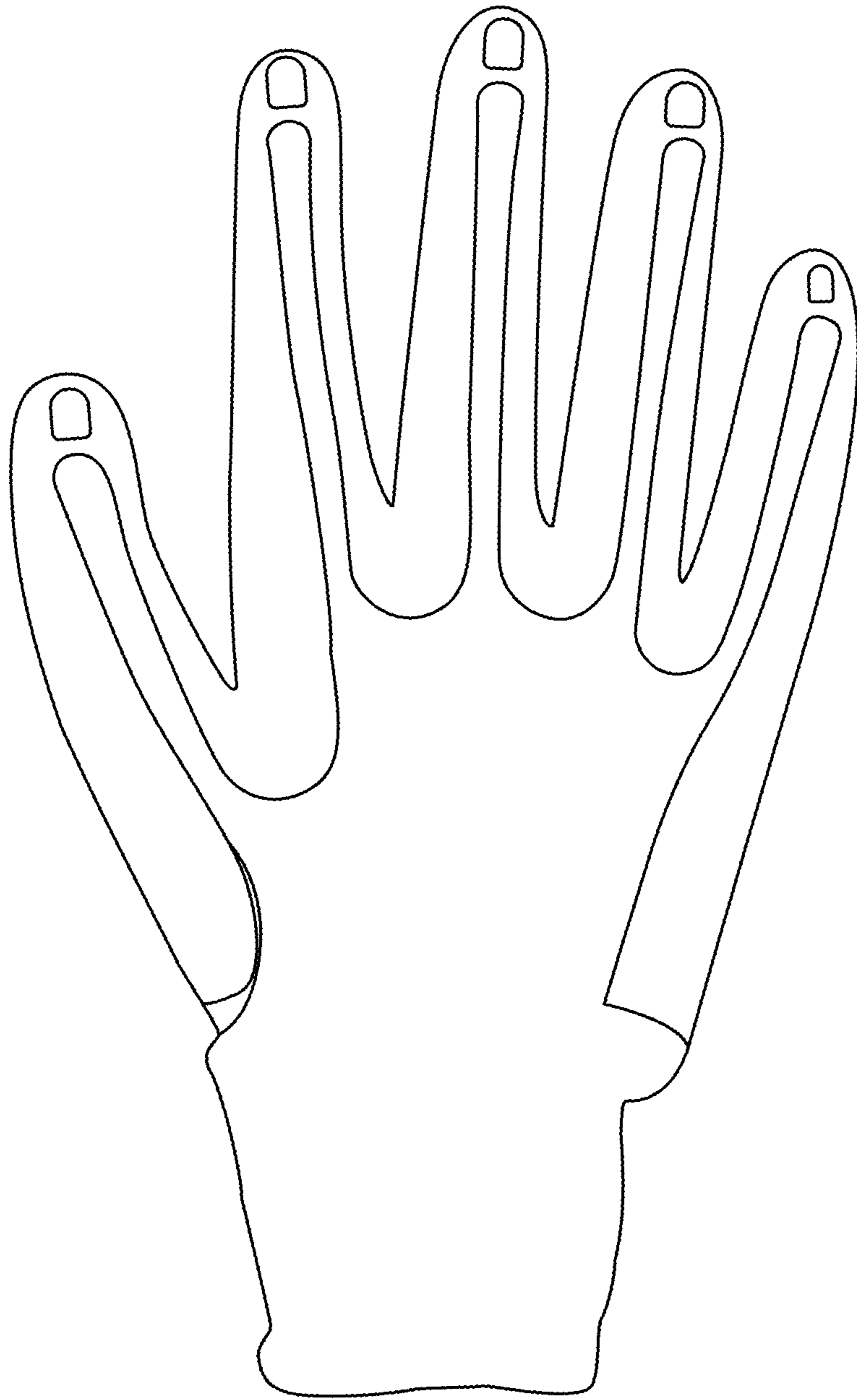

FIG.1

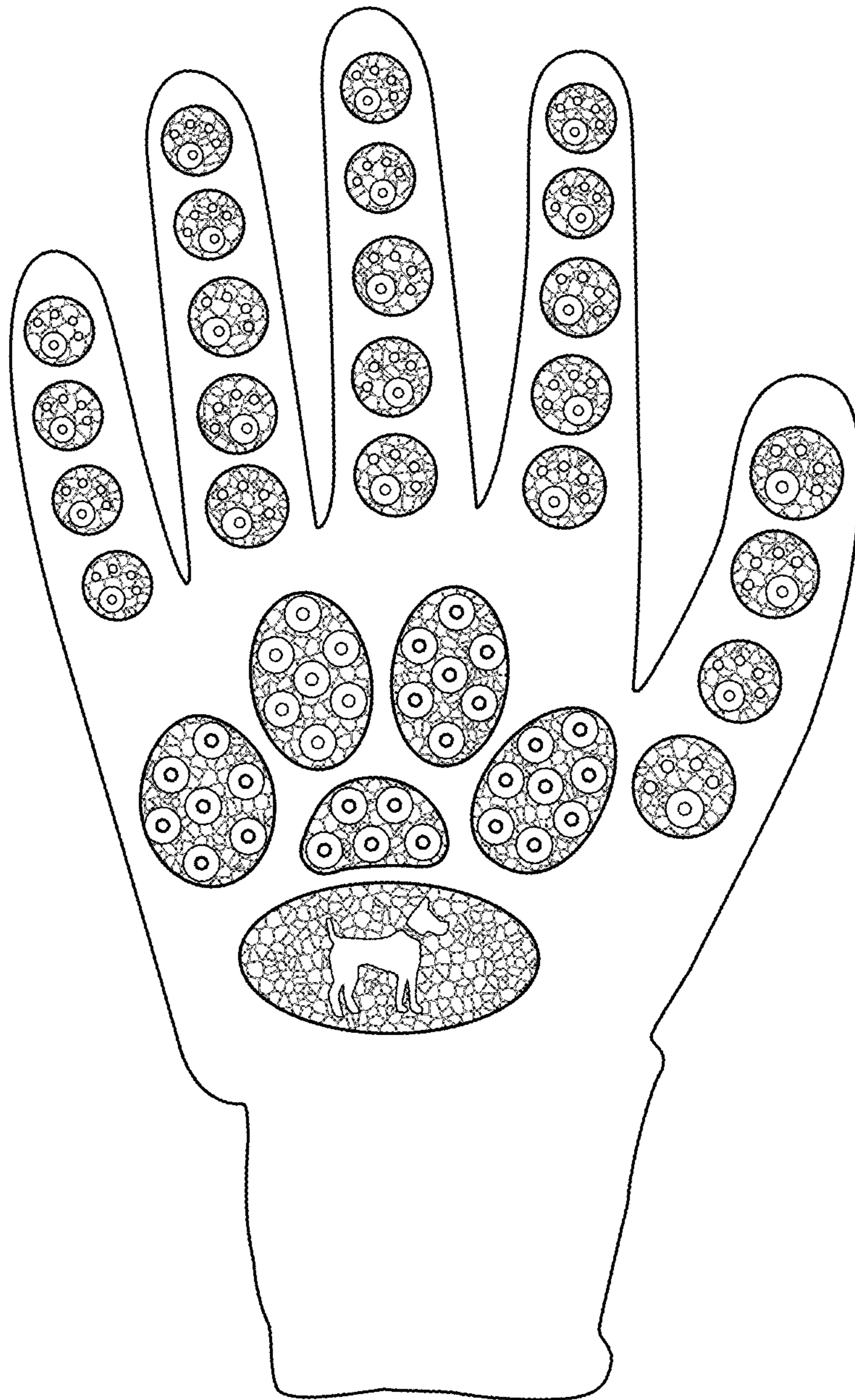

FIG.2

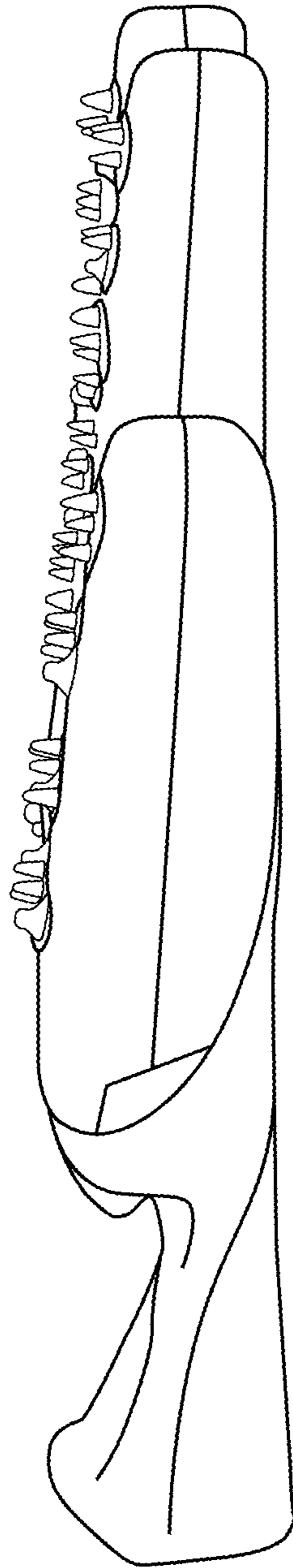

FIG.3

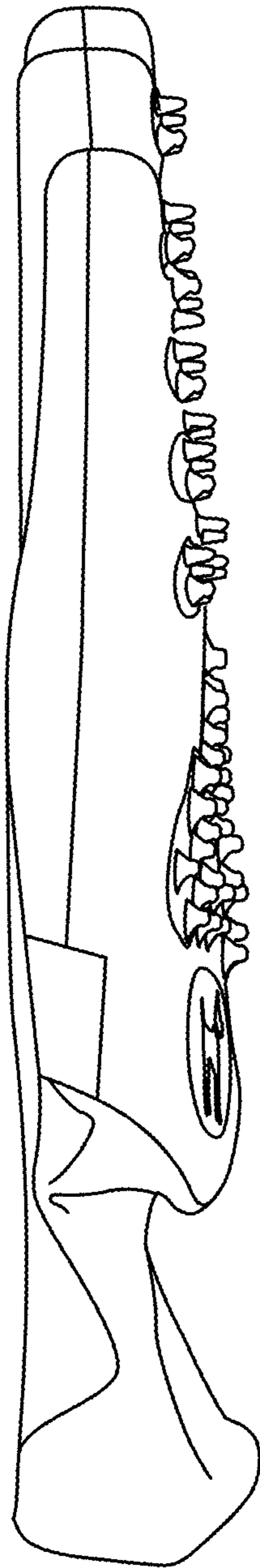

FIG.4

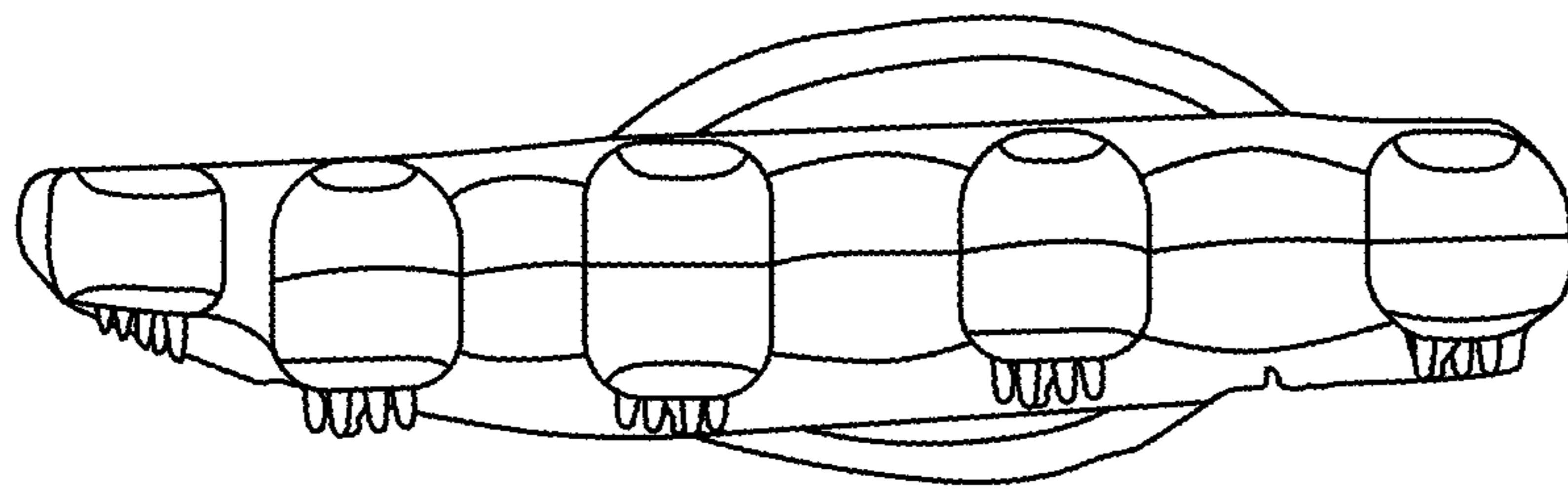

FIG.5



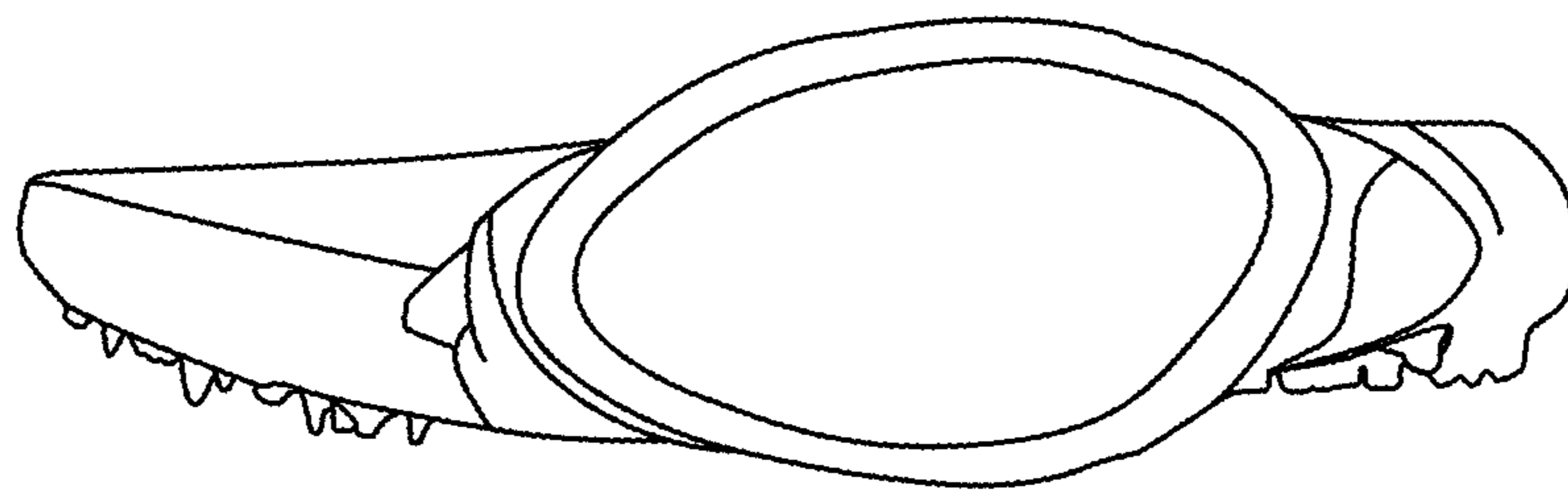

FIG.6

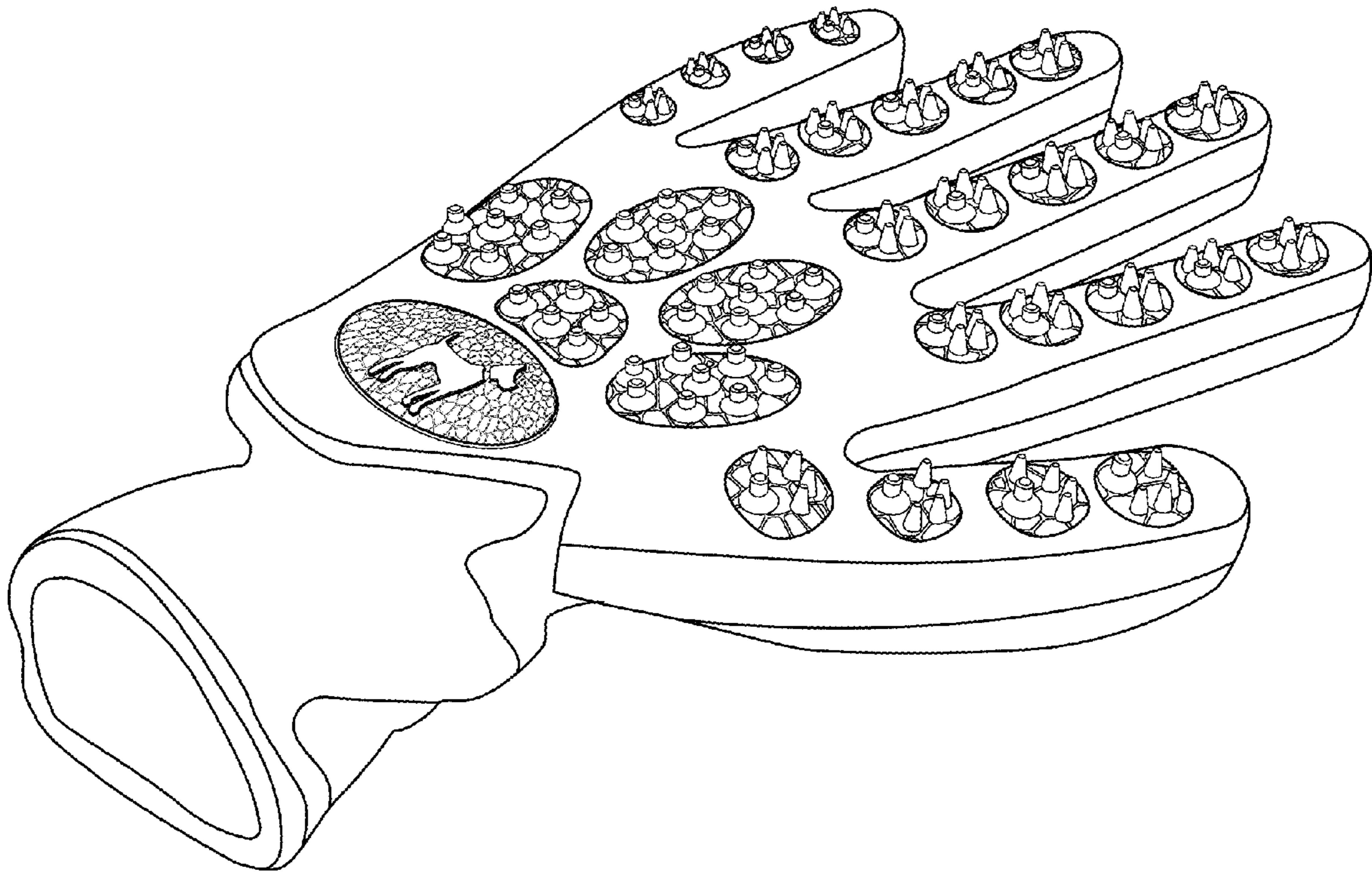

FIG.7