



US00D815345S

(12) **United States Design Patent**
Forecast

(10) **Patent No.:** **US D815,345 S**
(45) **Date of Patent:** **** Apr. 10, 2018**

(54) **PACKAGING CONTAINER**

(71) Applicant: **JT International S.A.**, Geneva (CH)

(72) Inventor: **Christopher Forecast**, London (GB)

(73) Assignee: **JT International S.A.**, Geneva (CH)

(**) Term: **15 Years**

(21) Appl. No.: **29/572,023**

(22) Filed: **Jul. 25, 2016**

(30) **Foreign Application Priority Data**

Jan. 25, 2016 (JP) 2016-001335

(51) **LOC (11) Cl.** **27-06**

(52) **U.S. Cl.**
USPC **D27/189; D9/420**

(58) **Field of Classification Search**
USPC D3/201, 202, 318; D7/387, 392, 392.1,
D7/396.2, 396.3, 397, 398; D9/414, 416,
D9/419, 420, 434-438, 440, 443, 445,
D9/447, 449, 454-456, 499; D24/224,
D24/227; D27/141, 144, 186, 187, 189,
D27/193, 194
CPC B65D 83/00
See application file for complete search history.

(56) **References Cited**

U.S. PATENT DOCUMENTS

- D219,957 S * 2/1971 Spahr D9/414
- 3,874,581 A * 4/1975 Fox B65D 5/6691
- 206/268
- D377,235 S * 1/1997 Inoue D27/141
- D379,248 S * 5/1997 Khemarangsana D27/141
- D432,263 S * 10/2000 Issa D27/187
- D446,601 S * 8/2001 Fisher D27/129
- D487,532 S * 3/2004 Draghetti D27/189

(Continued)

OTHER PUBLICATIONS

AliExpress. Light Aluminum Cigar Cigarette Case. 2017 [earliest online date], [site visited Apr. 28, 2017]. Available from Internet,

<URL:https://www.aliexpress.com/item/1pcs-Light-Aluminum-Cigar-Cigarette-Case-Tobacco-Holder-Pocket-Box-Storage-Container-New/32788504188.html?spm=2114.40010308.4.2.fBh41o>.*

Primary Examiner — Robert M. Spear

Assistant Examiner — Darcey E Heflin

(74) *Attorney, Agent, or Firm* — Ohlandt, Greeley, Ruggiero & Perle, L.L.P.

(57) **CLAIM**

The ornamental design for a packaging container, as shown and described.

DESCRIPTION

FIG. 1 is a front elevation view of a packaging container. FIG. 2 is a rear elevation view thereof. FIG. 3 is a left side elevation view thereof. FIG. 4 is a right side elevation view thereof. FIG. 5 is a top plan view thereof. FIG. 6 is a bottom plan view thereof. FIG. 7 is a cross-sectional view taken along the line 7-7 in FIG. 5 thereof. FIG. 8 is a cross-sectional view taken along the line 8-8 in FIG. 5 thereof. FIG. 9 is a perspective view with the lid closed. FIG. 10 is a front elevation view with the lid closed. FIG. 11 is a rear elevation view with the lid closed. FIG. 12 is a left elevation view with the lid closed. FIG. 13 is a right elevation view with the lid closed. FIG. 14 is a top plan view with the lid closed. FIG. 15 is a bottom plan view with the lid closed. FIG. 16 is a cross-sectional view taken along the line 16-16 in FIG. 14 thereof; and, FIG. 17 a cross-sectional view of the packaging container of FIG. 8 in an environment of use.

The broken lines shown in the drawings illustrate portions of the packaging container that form no part of claimed design.

1 Claim, 17 Drawing Sheets

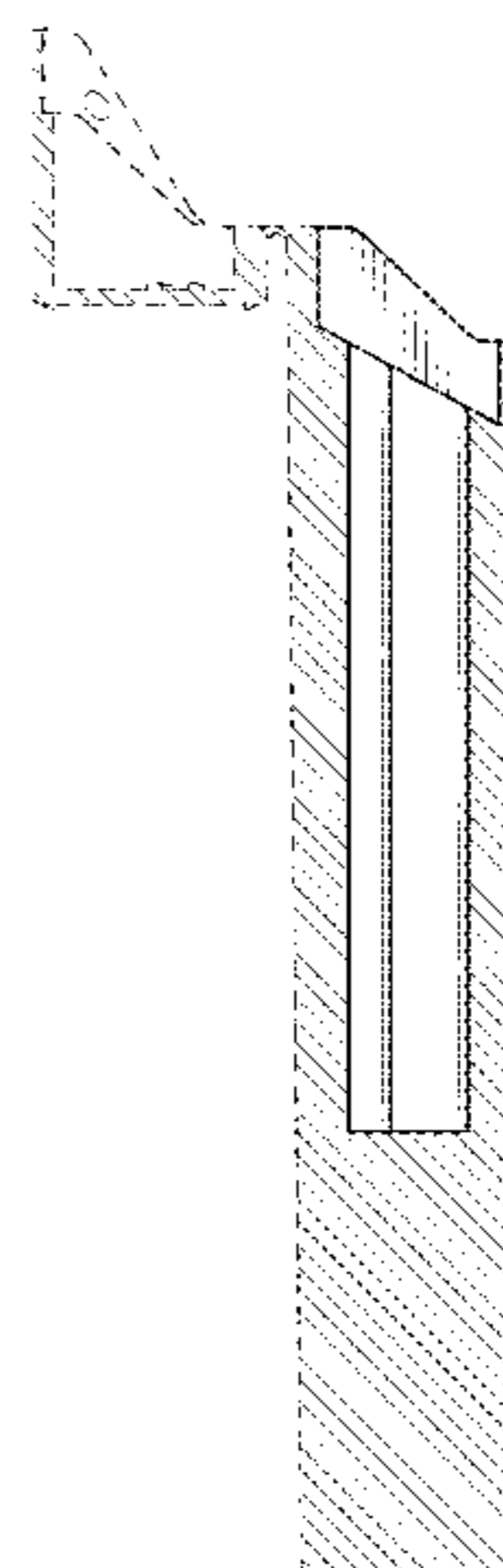
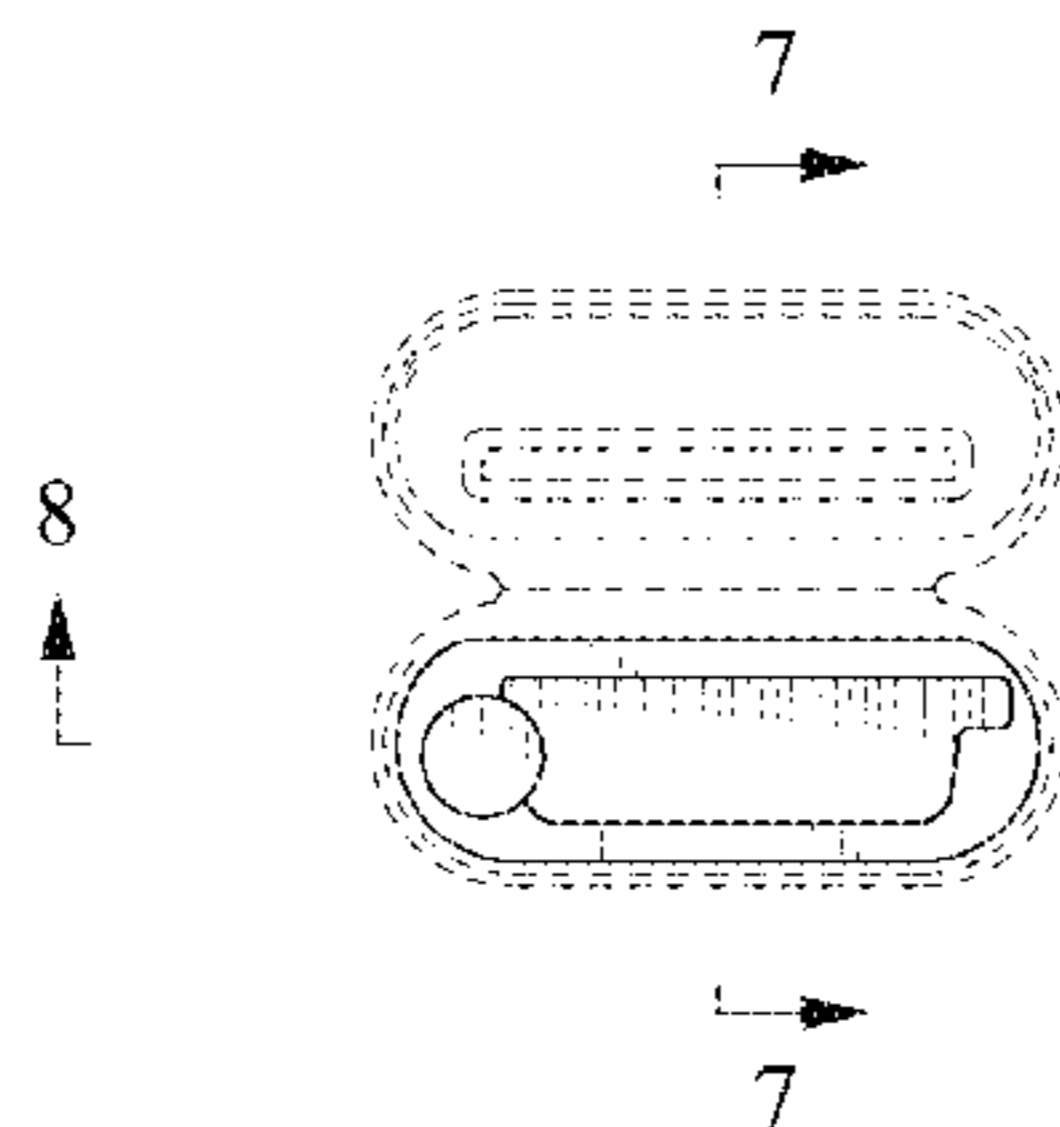

(56)

References Cited

U.S. PATENT DOCUMENTS

D541,471 S * 4/2007 Mitten D27/189
 D591,898 S * 5/2009 McKenzie D27/187
 D609,398 S * 2/2010 Hearn D27/189
 D618,544 S * 6/2010 Collins D9/420
 D656,094 S * 3/2012 Wu D13/108
 D661,183 S * 6/2012 Villiers D9/434
 D671,677 S * 11/2012 Wu D27/189
 D671,678 S * 11/2012 Wu D27/189
 D673,039 S * 12/2012 Villiers D9/434
 D675,095 S * 1/2013 Villiers D9/434
 D675,915 S * 2/2013 Villiers D9/420
 D676,322 S * 2/2013 Villiers D9/456
 D679,178 S * 4/2013 Villiers D9/420
 D681,337 S * 5/2013 Wu D3/318
 D683,540 S * 6/2013 Phillips D3/303
 D683,898 S 6/2013 Liu
 D683,899 S * 6/2013 Liu D13/108
 D685,579 S * 7/2013 Phillips D3/303
 D688,418 S * 8/2013 Liu D13/108
 D706,976 S * 6/2014 Wu D27/189
 D719,701 S * 12/2014 Scatterday D27/189

D723,733 S * 3/2015 Liu D27/189
 D723,734 S * 3/2015 Liu D27/189
 D723,735 S * 3/2015 Liu D27/189
 D723,736 S * 3/2015 Liu D27/189
 D723,737 S * 3/2015 Liu D27/189
 D725,823 S * 3/2015 Scatterday A24F 15/12
 D730,052 S * 5/2015 Curran-Blaney D14/251
 D733,961 S * 7/2015 Wu D27/189
 D735,936 S * 8/2015 Liu D27/189
 D736,455 S * 8/2015 Liu D27/189
 D736,996 S * 8/2015 Liu D27/189
 D737,506 S * 8/2015 Liu D27/189
 D741,002 S * 10/2015 Liu D27/189
 D747,188 S * 1/2016 Candelaria D9/430
 9,302,825 B2 * 4/2016 Liu B65D 43/163
 D756,650 S * 5/2016 Sweeney D3/303
 D760,431 S * 6/2016 Liu D27/189
 D770,679 S * 11/2016 Weigensberg D27/189
 D773,989 S * 12/2016 Schiff D13/107
 D775,414 S * 12/2016 Ampolini D13/108
 D790,455 S * 6/2017 McGarry D13/107
 D793,004 S * 7/2017 Liu D27/189

* cited by examiner

FIG. 1

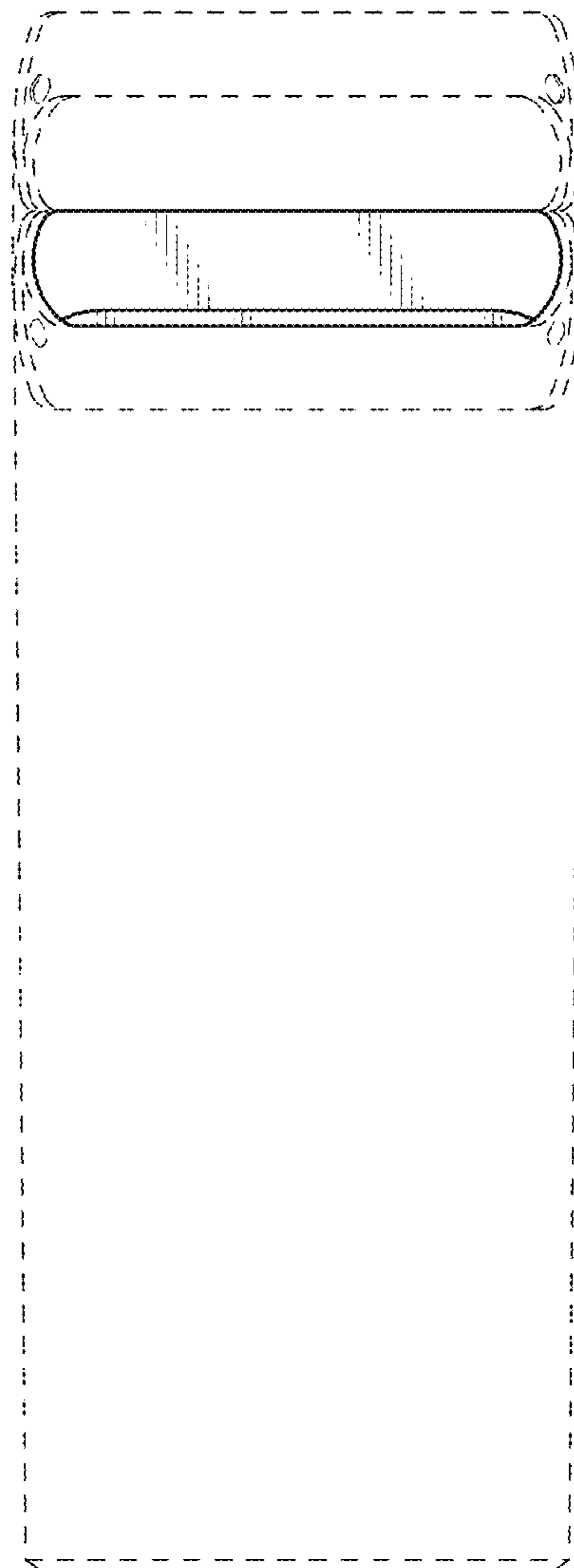

FIG. 2

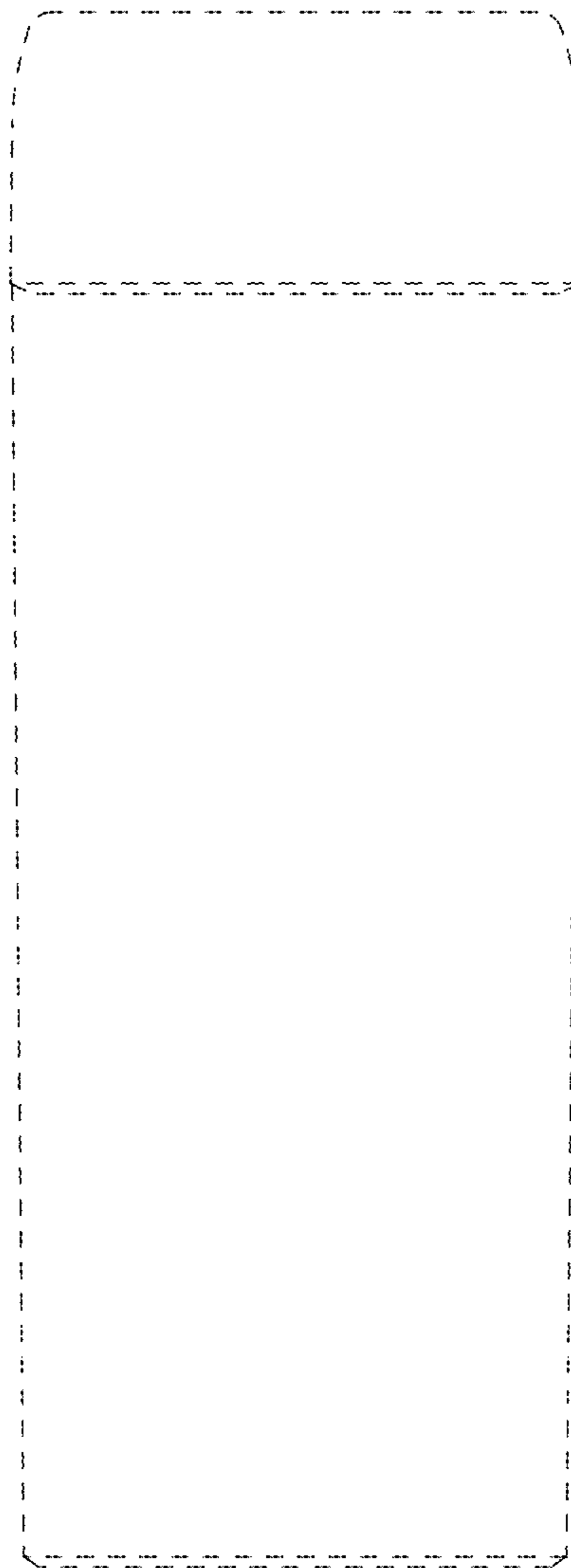

FIG. 3

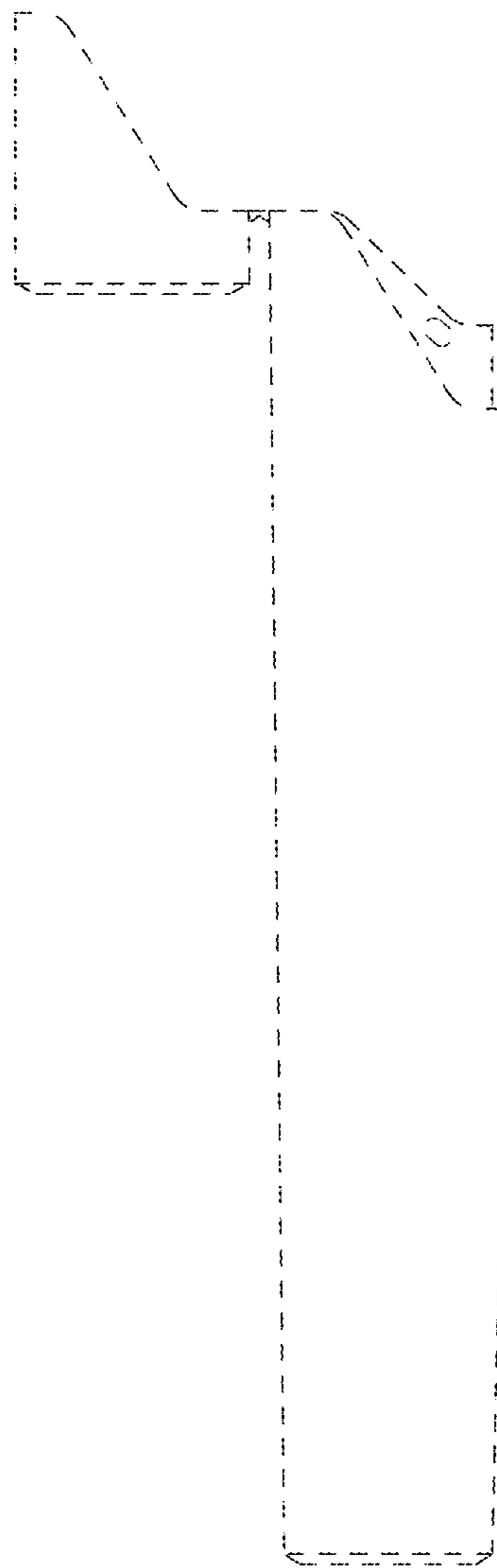

FIG. 4

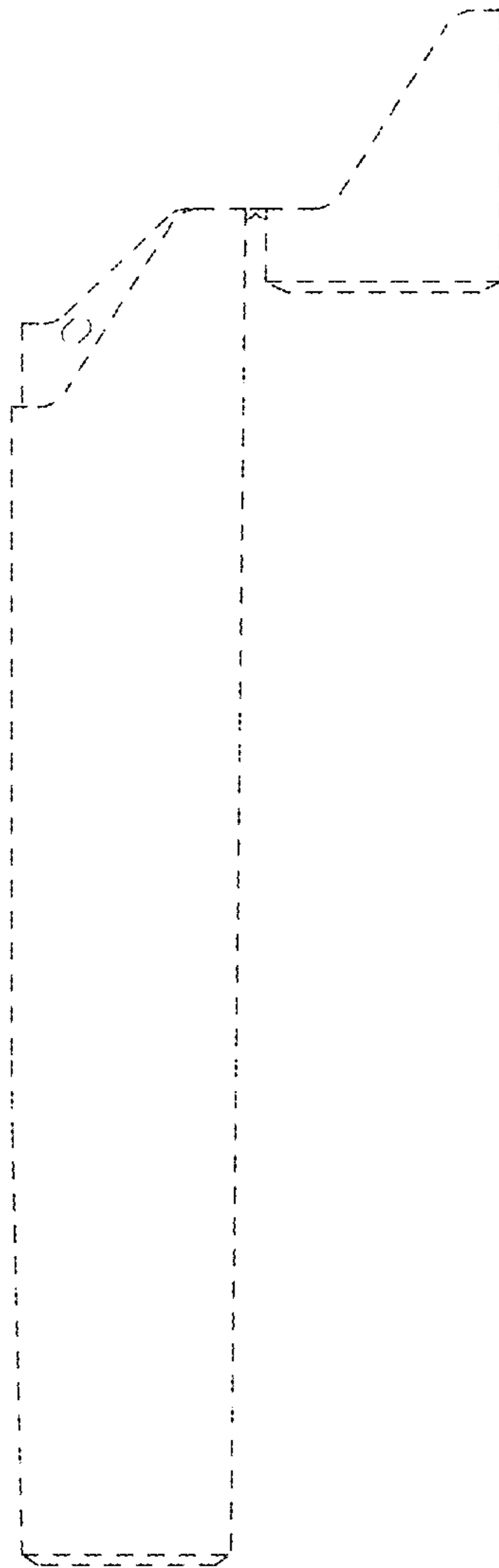

FIG. 5

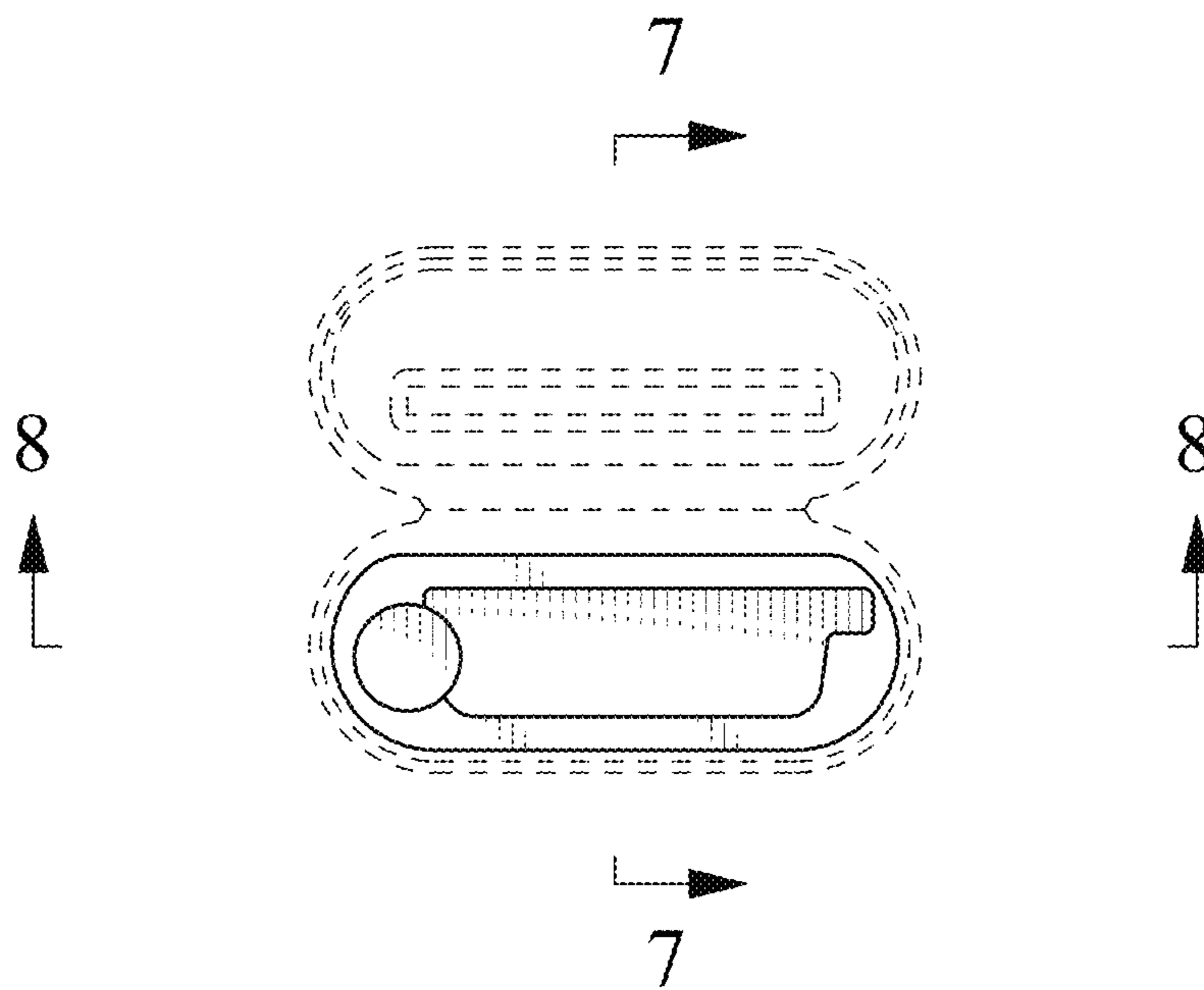

FIG. 6

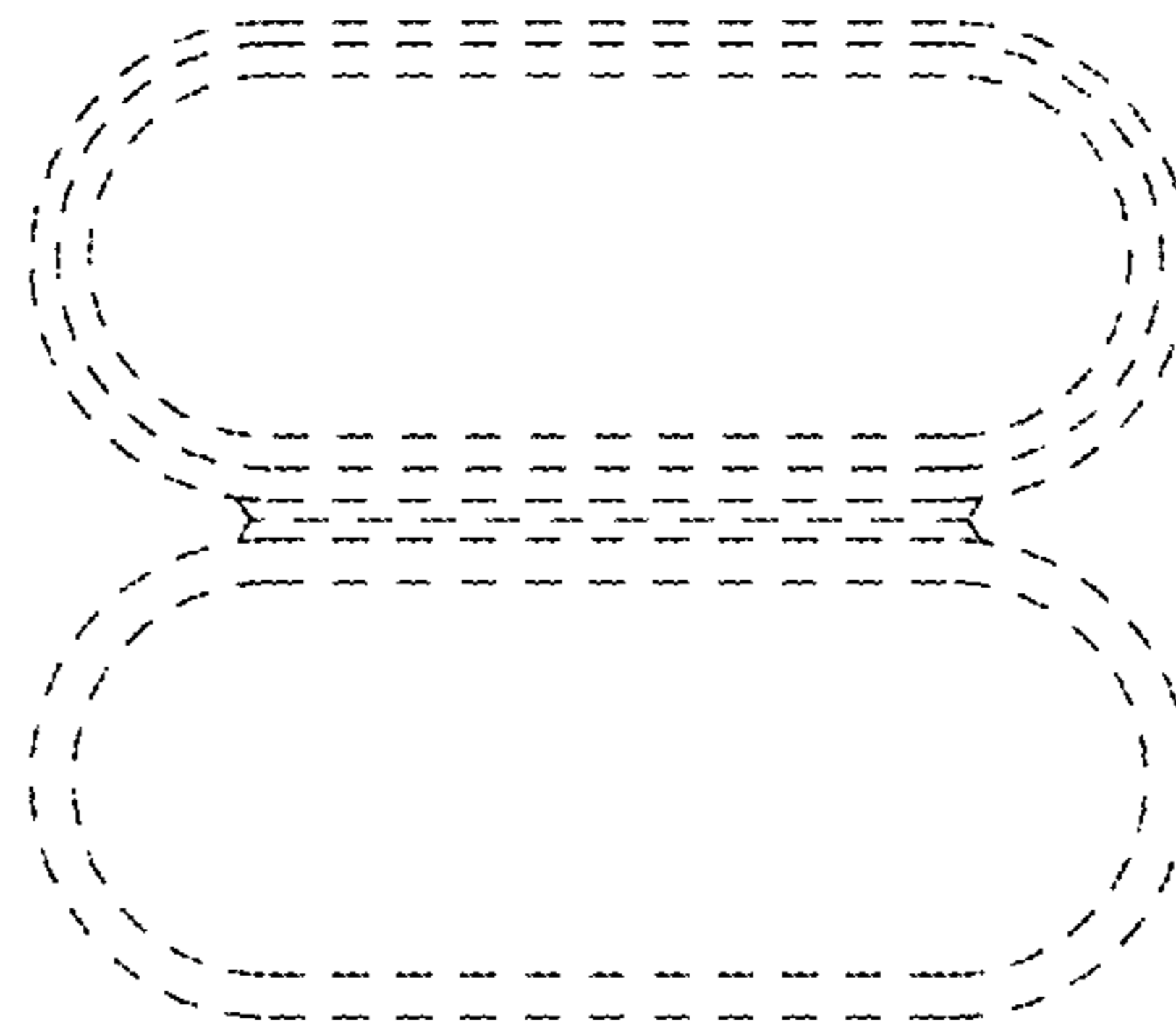

FIG. 7

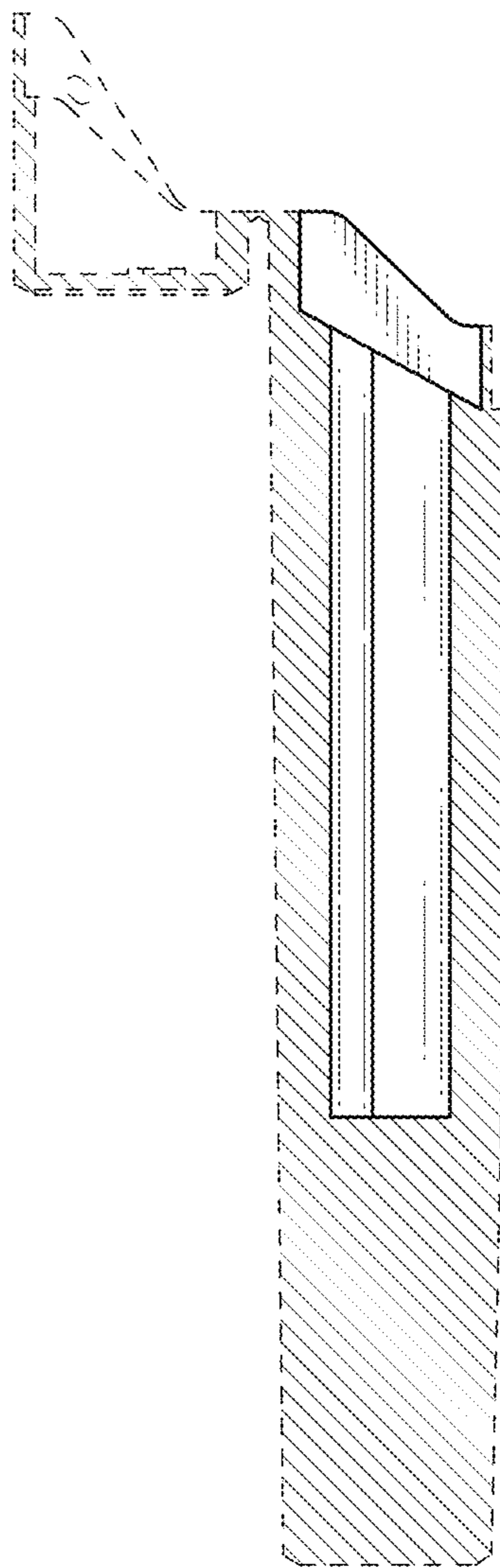

FIG. 8

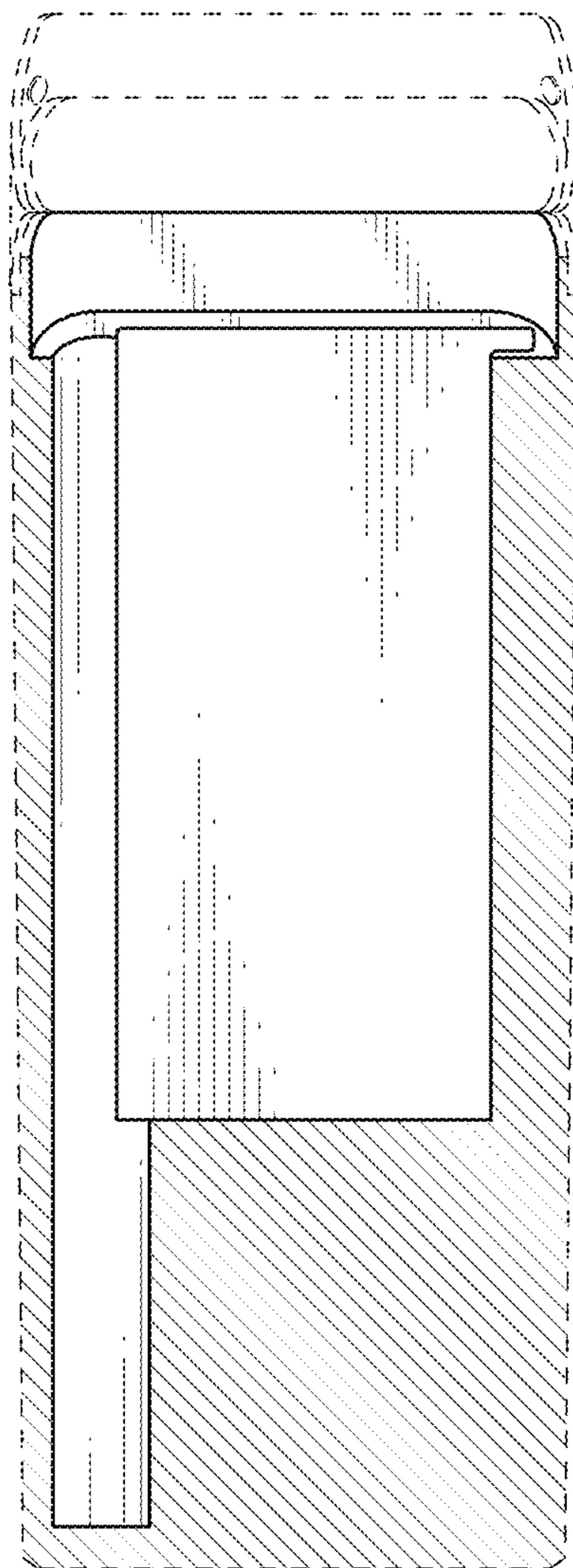

FIG. 9

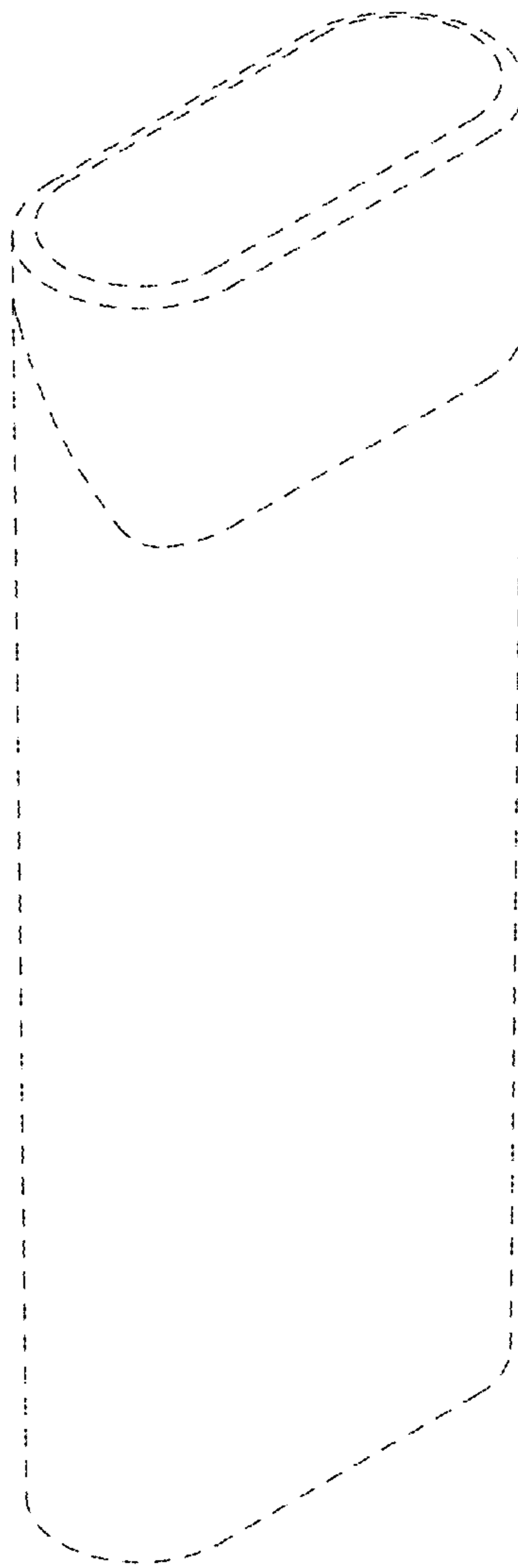

FIG. 10

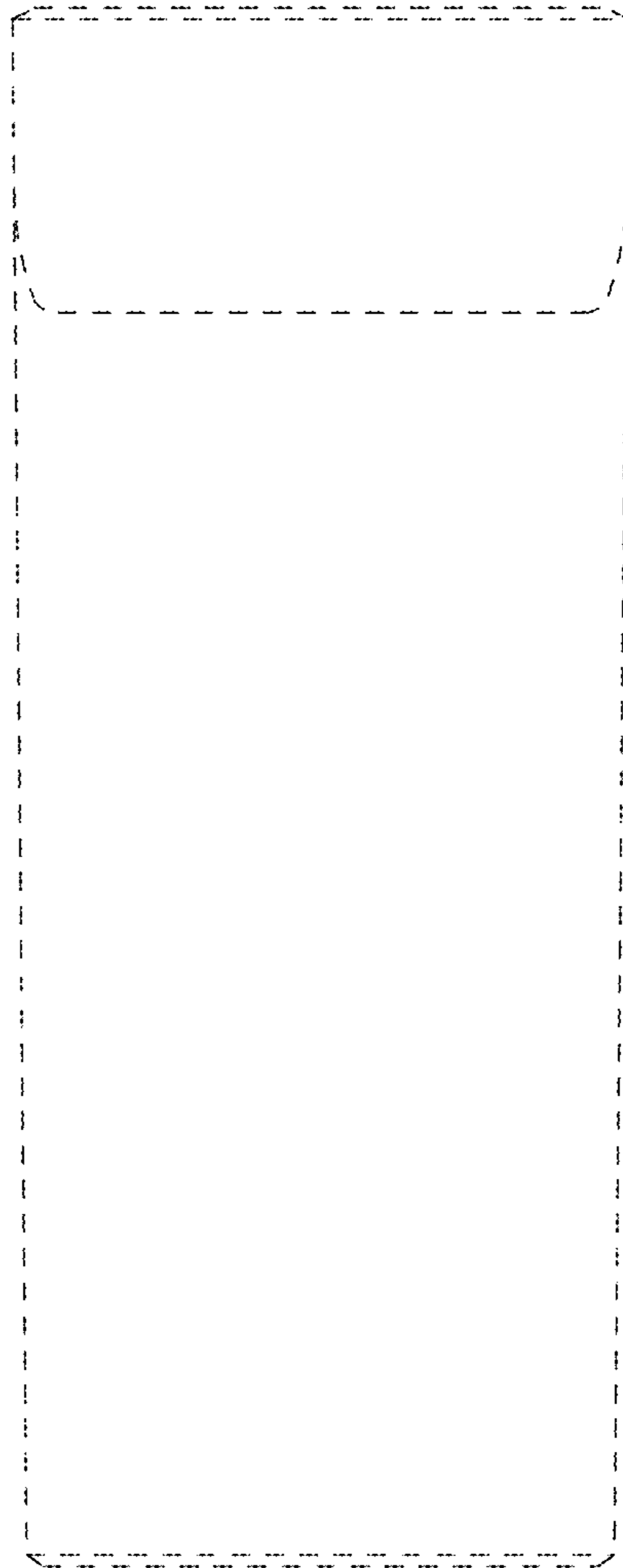

FIG. 11

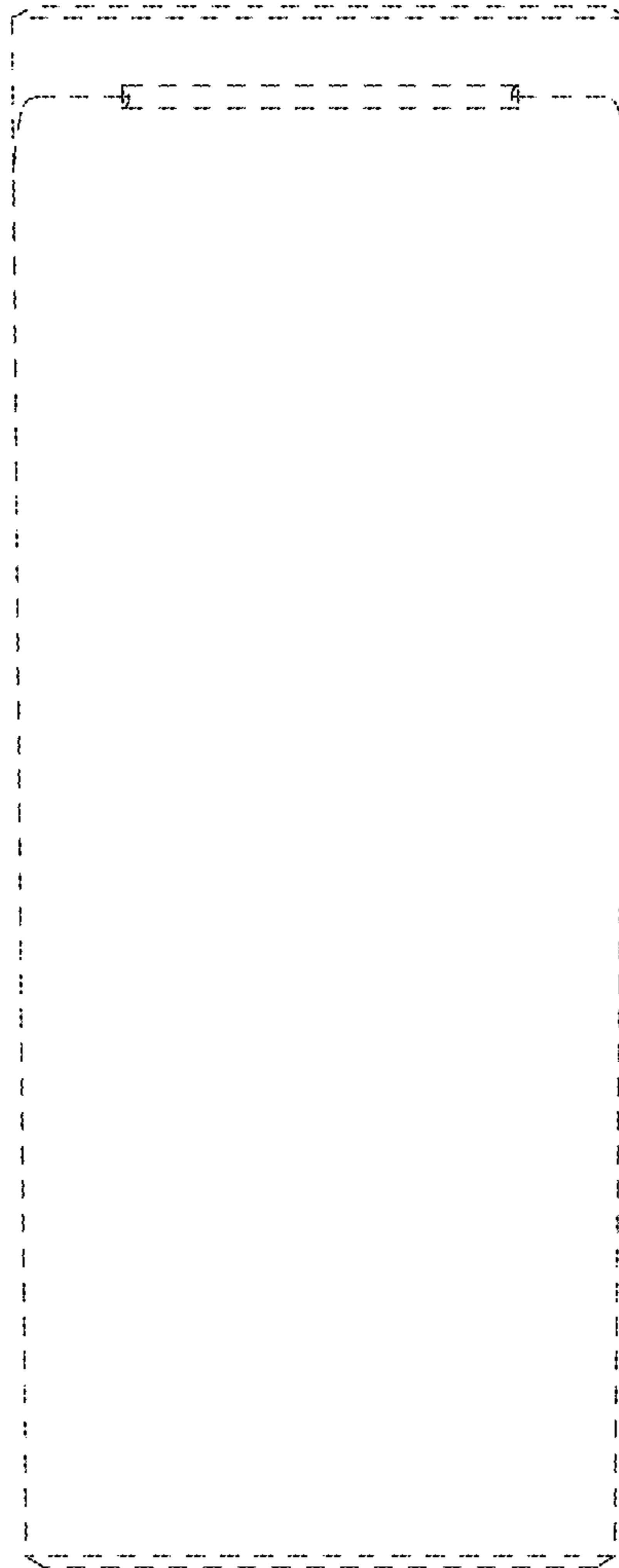

FIG. 12

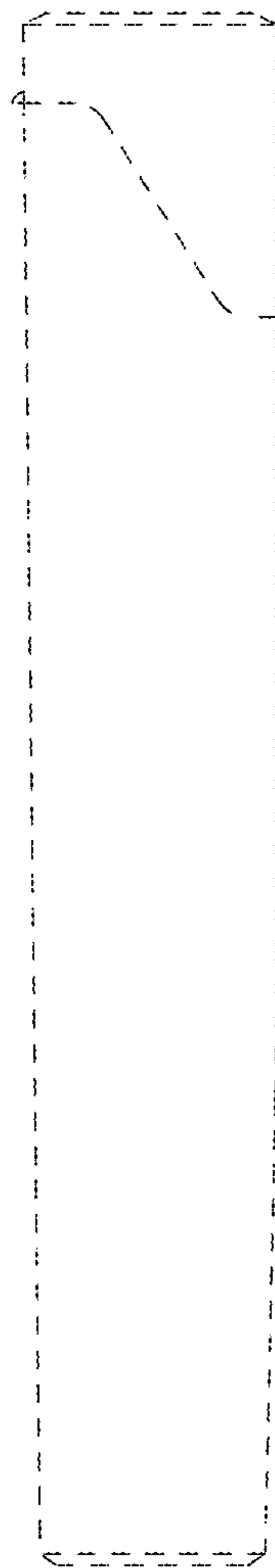

FIG. 13



FIG. 14

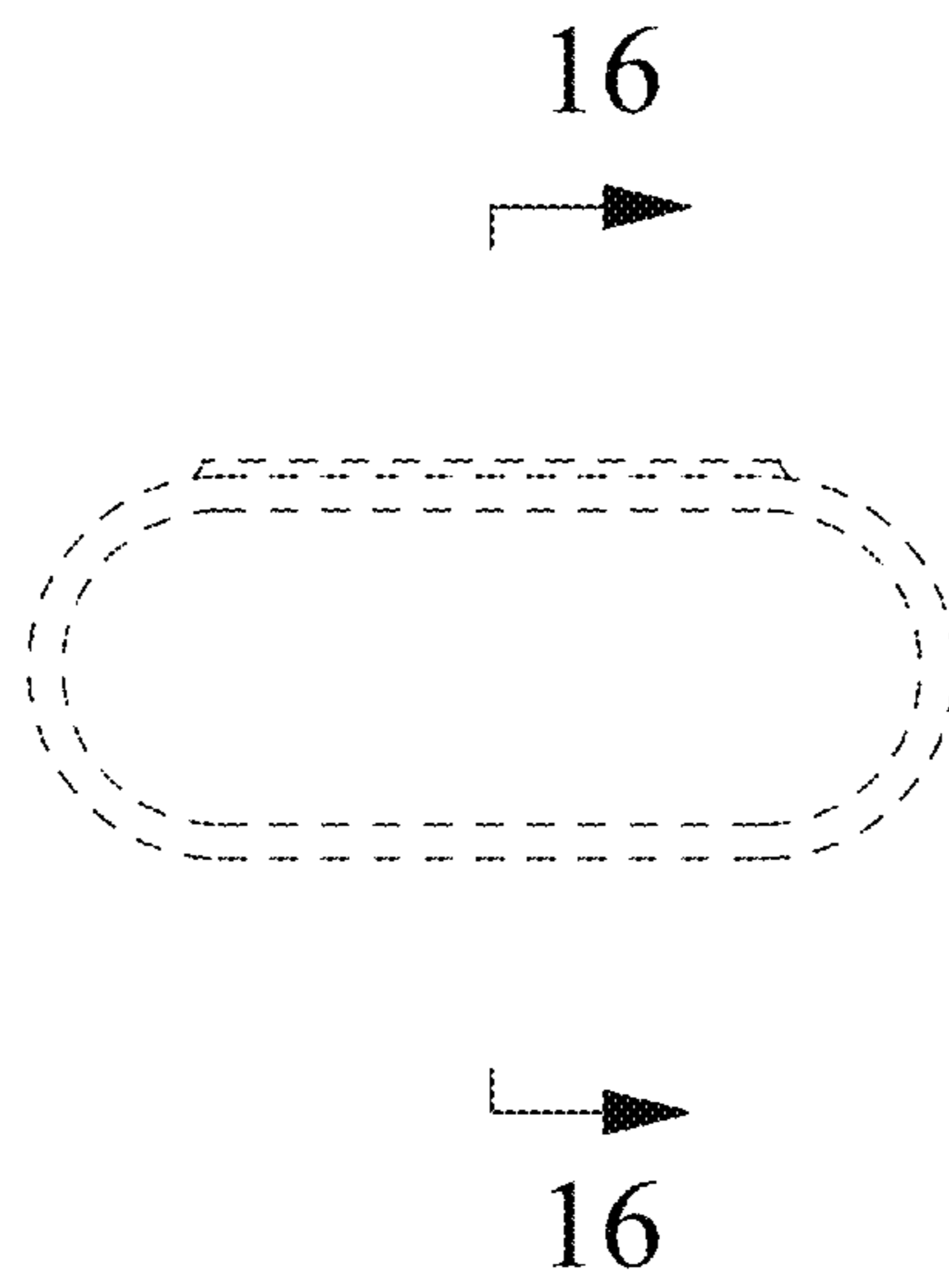

FIG. 15

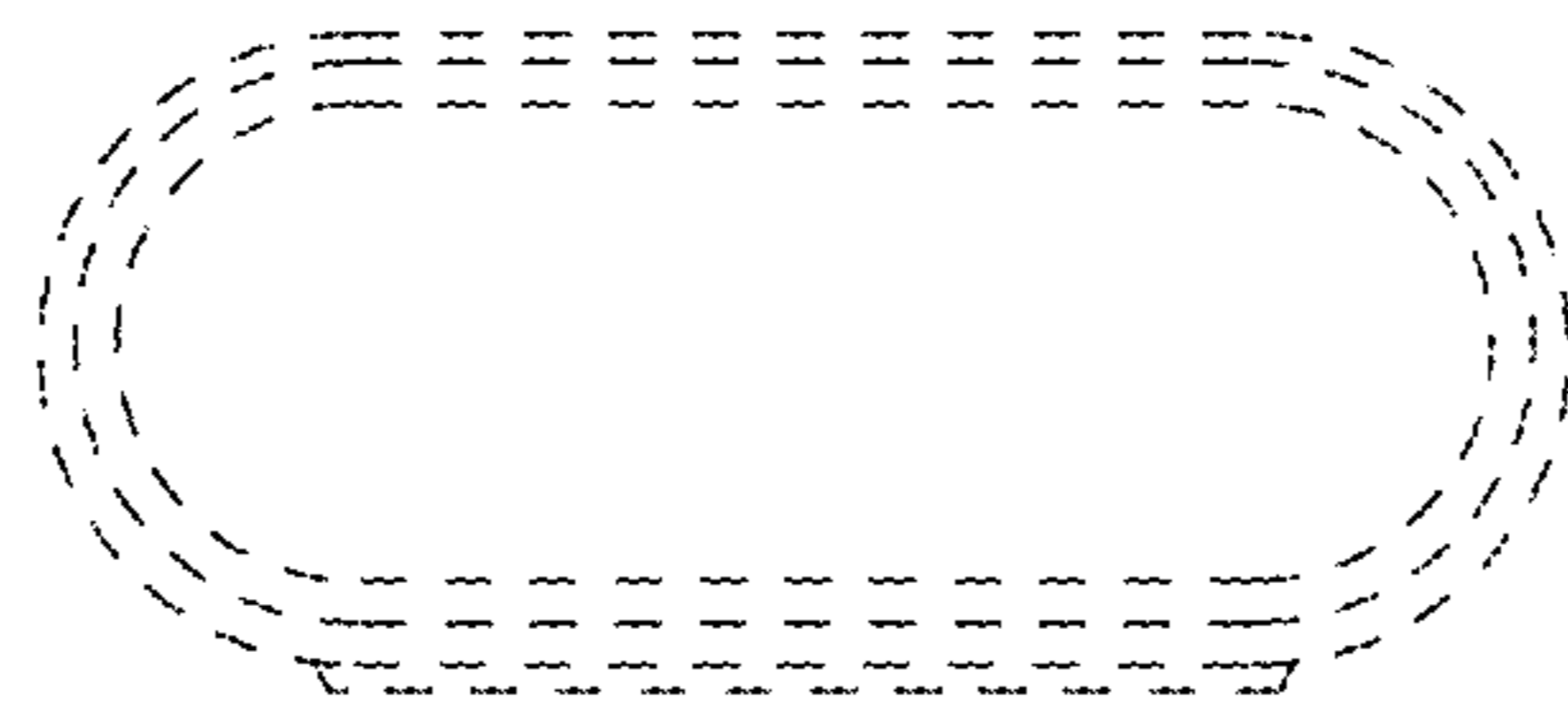

FIG. 16

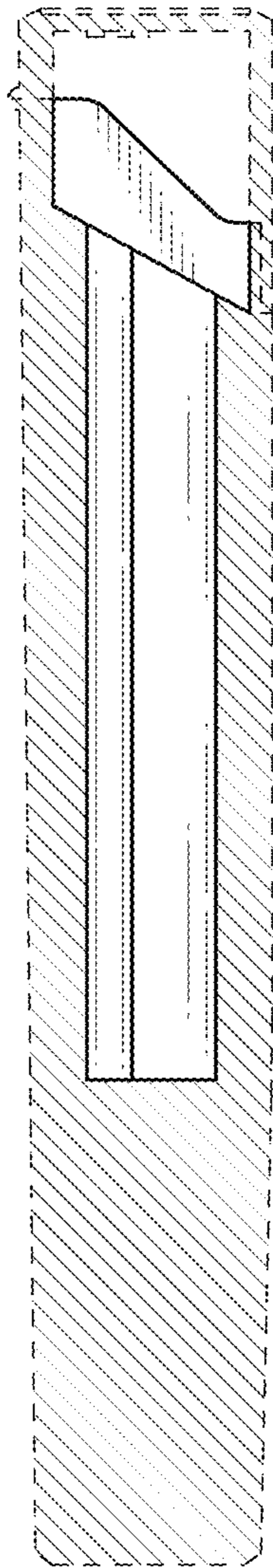

FIG. 17

