



US00D815159S

(12) **United States Design Patent**
Pagel et al.

(10) **Patent No.:** **US D815,159 S**
(45) **Date of Patent:** **** Apr. 10, 2018**

(54) **MECHANICAL DEBONDER**

(71) Applicant: **Cost Effective Equipment LLC**, Rolla, MO (US)

(72) Inventors: **Russell T. Pagel**, Rolla, MO (US);
Brandon L. Wilson, Lebanon, MO (US)

(73) Assignee: **Cost Effective Equipment LLC**, Rolla, MO (US)

(**) Term: **15 Years**

(21) Appl. No.: **29/564,848**

(22) Filed: **May 16, 2016**

(51) **LOC (11) Cl.** **15-09**

(52) **U.S. Cl.**
USPC **D15/122**

(58) **Field of Classification Search**
USPC 15/122, 138, 199
CPC B32B 38/10
See application file for complete search history.

(56) **References Cited**

U.S. PATENT DOCUMENTS

3,906,118	A *	9/1975	McFarland	A22C 17/04 426/479
2007/0181259	A1 *	8/2007	Bar-Erez	B29C 67/0074 156/524
2008/0185094	A1 *	8/2008	Hussain	G07B 17/00508 156/247
2010/0263794	A1 *	10/2010	George	B32B 43/006 156/707
2011/0253314	A1 *	10/2011	George	B32B 43/006 156/706
2011/0253315	A1 *	10/2011	George	B32B 43/006 156/718
2012/0234497	A1 *	9/2012	Han, II	H01L 21/67092 156/701
2013/0048224	A1 *	2/2013	George	H01L 21/67282 156/752

(Continued)

Primary Examiner — Patricia A Palasik

(74) *Attorney, Agent, or Firm* — Hovey Williams LLP

(57) **CLAIM**

The ornamental design for a mechanical debonder, as shown and described.

DESCRIPTION

FIG. 1 is a front left perspective view of a mechanical debonder embodying our design;
 FIG. 2 is a front right perspective view of the mechanical debonder shown in FIG. 1;
 FIG. 3 is a front elevation view of the mechanical debonder shown in FIGS. 1 and 2;
 FIG. 4 is a left side elevation view of the mechanical debonder depicted in FIGS. 1-3;
 FIG. 5 is a right side elevation view of the mechanical debonder depicted in FIGS. 1-4;
 FIG. 6 is a top elevation view of the mechanical debonder depicted in FIGS. 1-5;
 FIG. 7 is a front left perspective view of a mechanical debonder similar to FIG. 1, but with additional features being depicted in broken lines for illustrative purposes only and forming no part of the claimed design;
 FIG. 8 is a front right perspective view of the mechanical debonder as depicted in FIG. 7;
 FIG. 9 is a front elevation view of the mechanical debonder as depicted in FIGS. 7 and 8;
 FIG. 10 is a left side elevation view of the mechanical debonder as depicted in FIGS. 7-9;
 FIG. 11 is a right side elevation view of the mechanical debonder as depicted in FIGS. 7-10; and,
 FIG. 12 is a top elevation view of the mechanical debonder as depicted in FIGS. 7-11.
 The broken lines are directed to environment and/or are for illustrative purposes only. None of the broken lines form part of the claimed design.

1 Claim, 12 Drawing Sheets

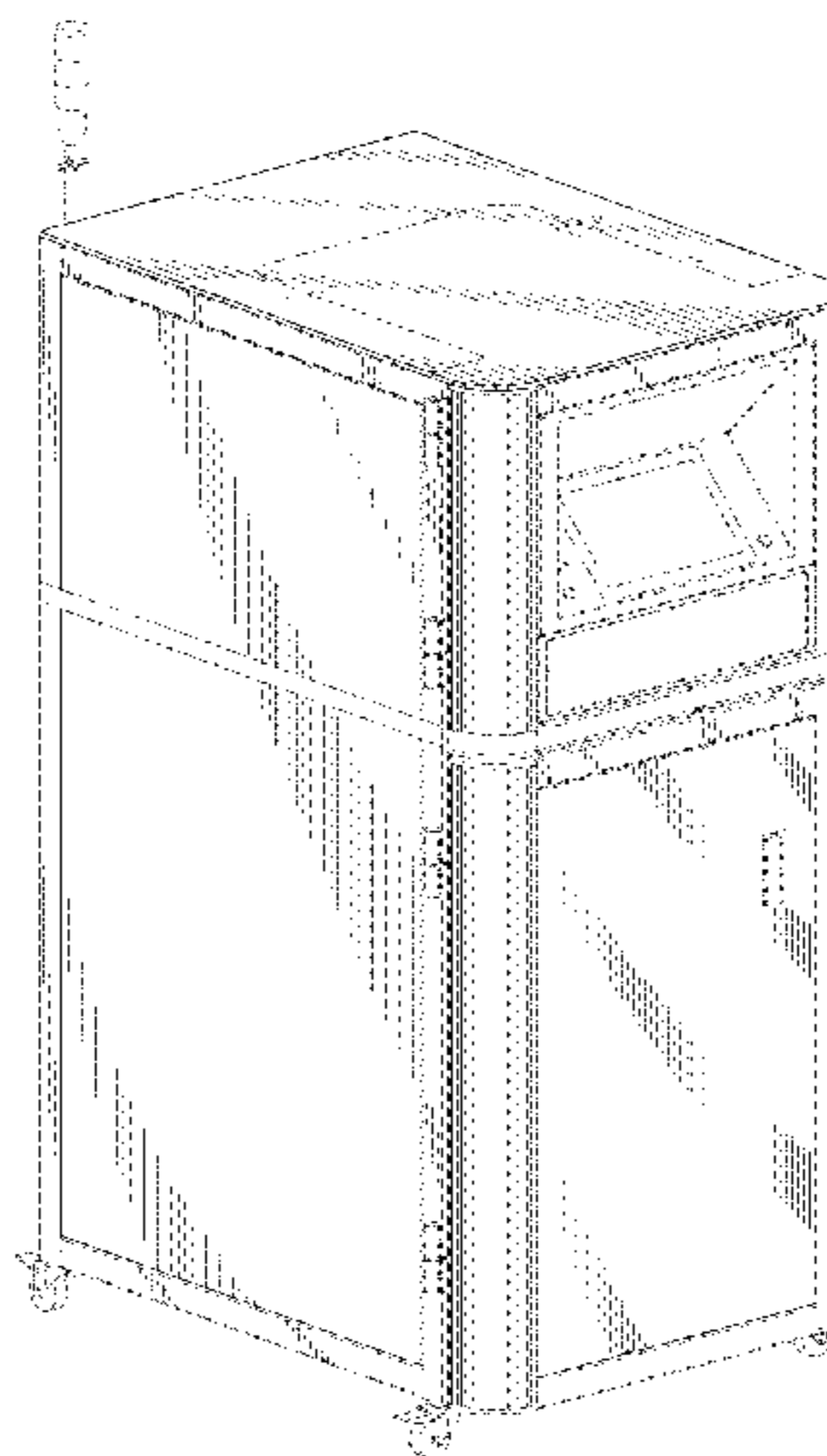
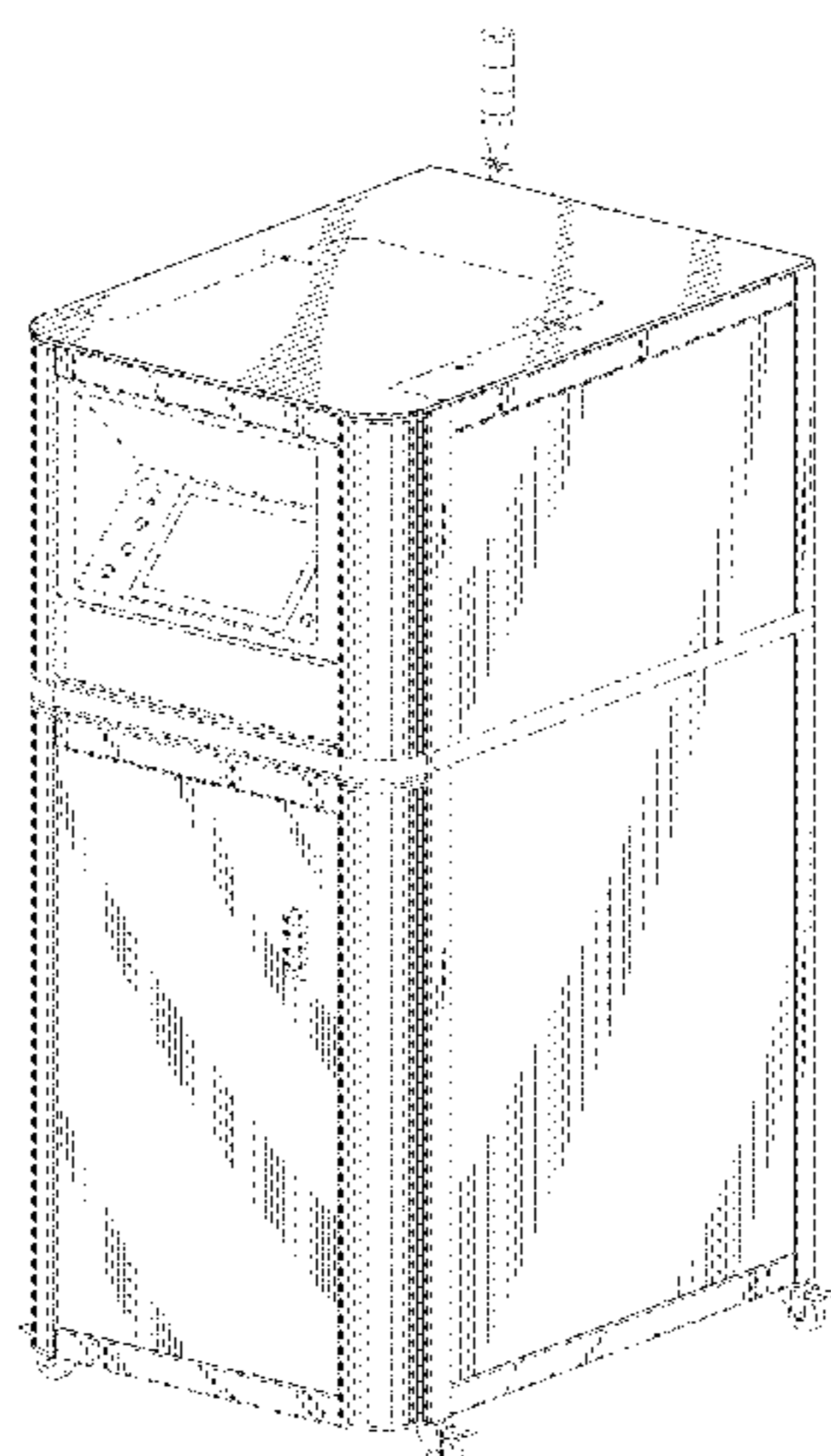

(56)

References Cited

U.S. PATENT DOCUMENTS

2013/0105090 A1* 5/2013 Lee B32B 38/10
156/705

* cited by examiner

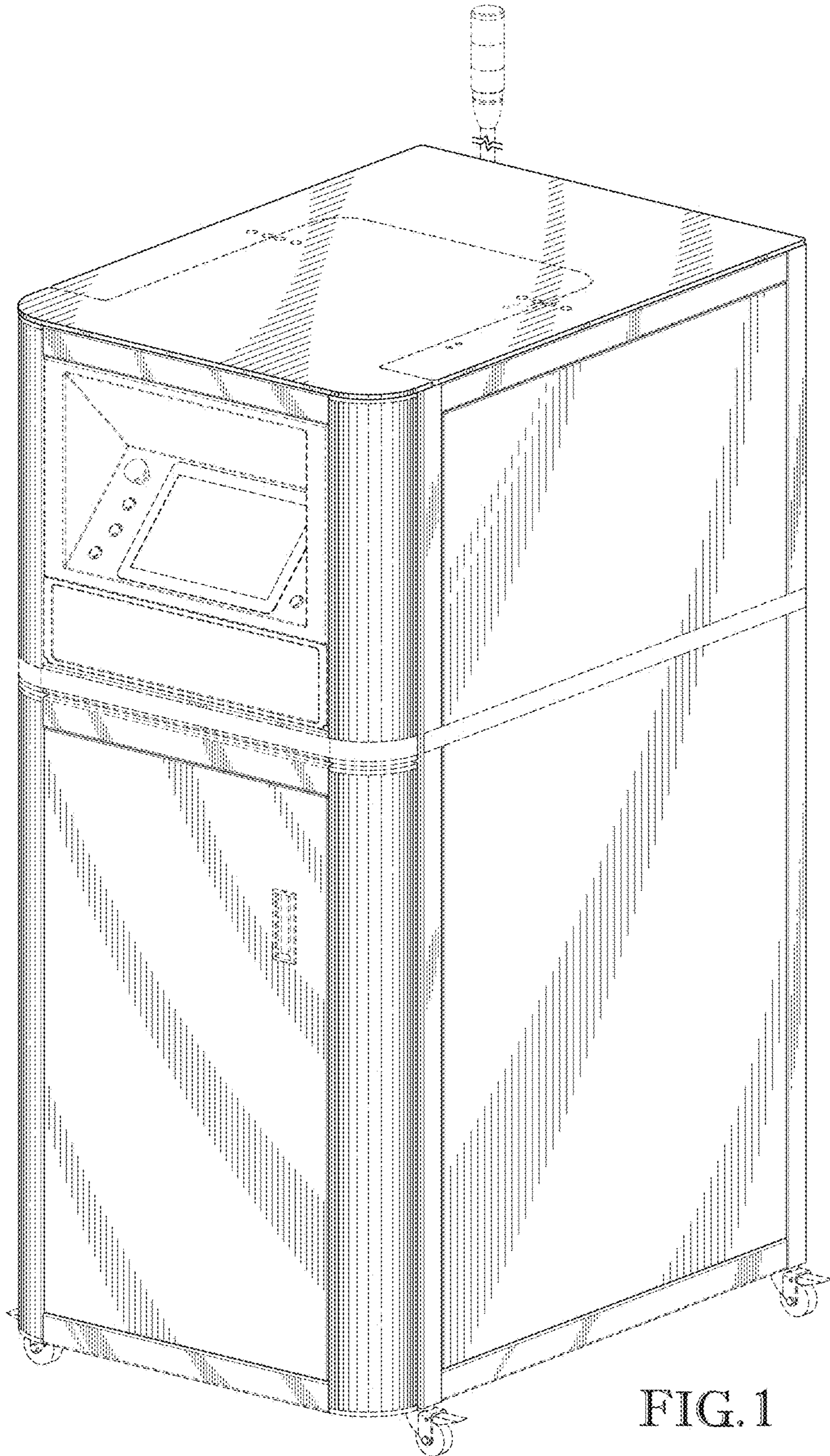

FIG. 1

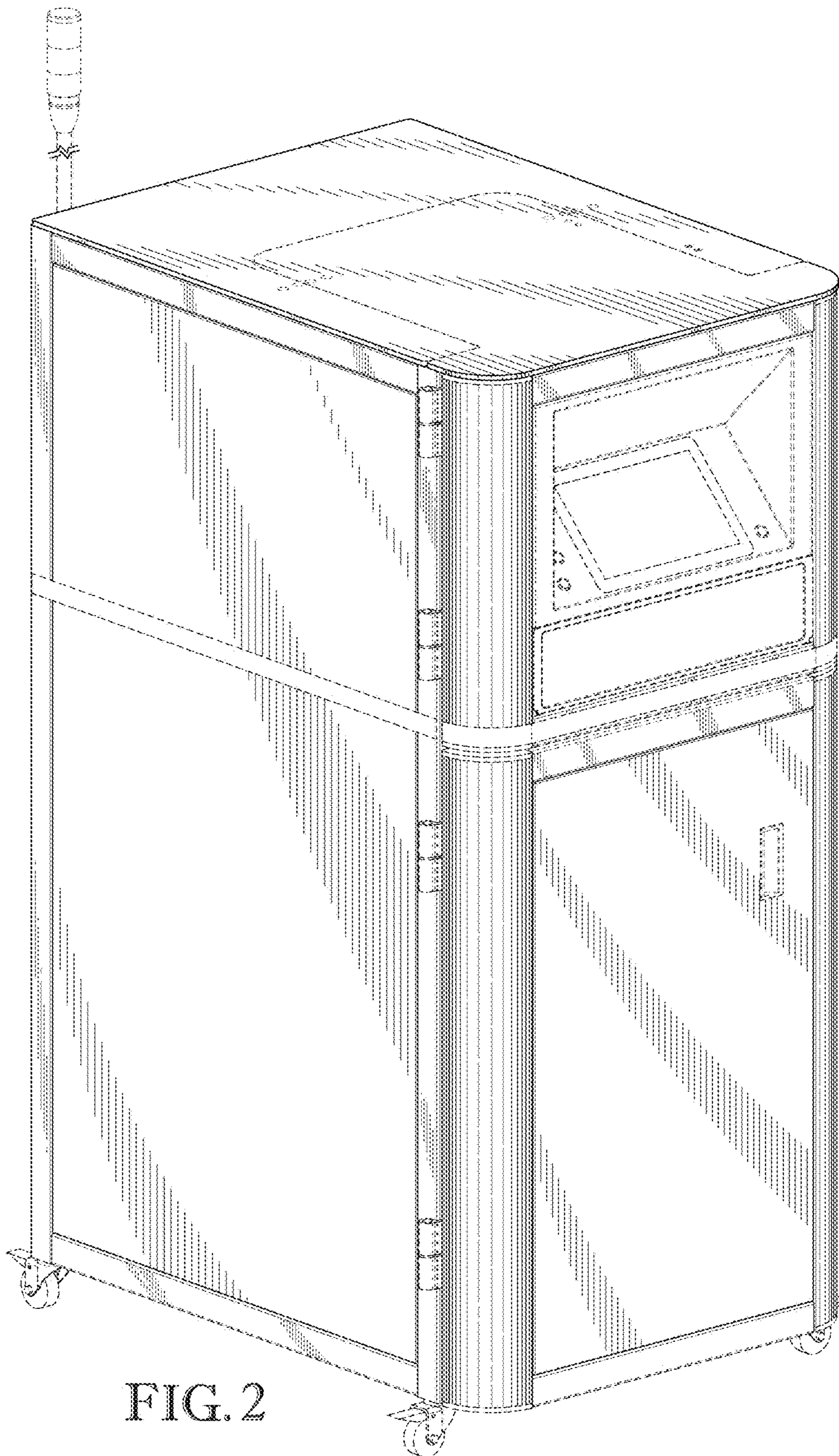

FIG. 2

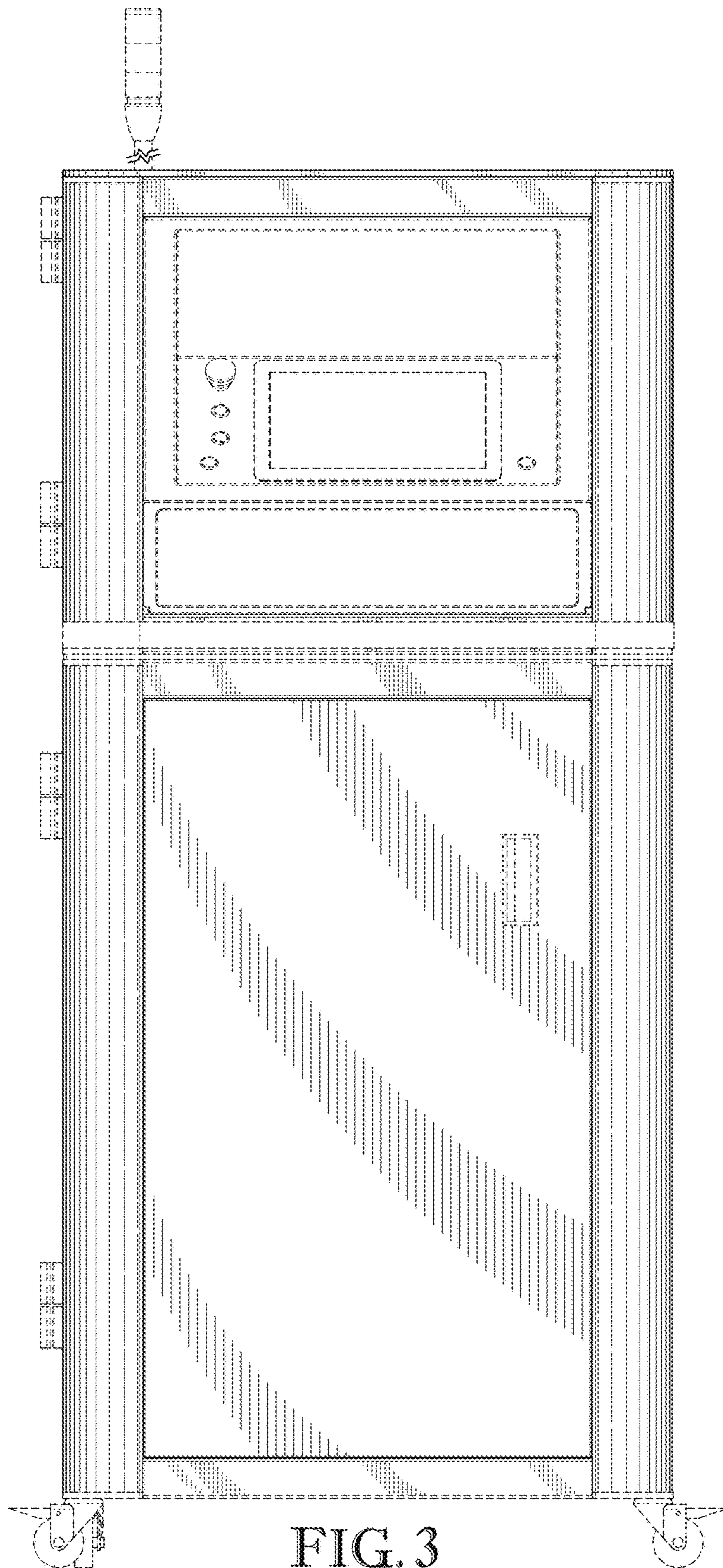

FIG. 3

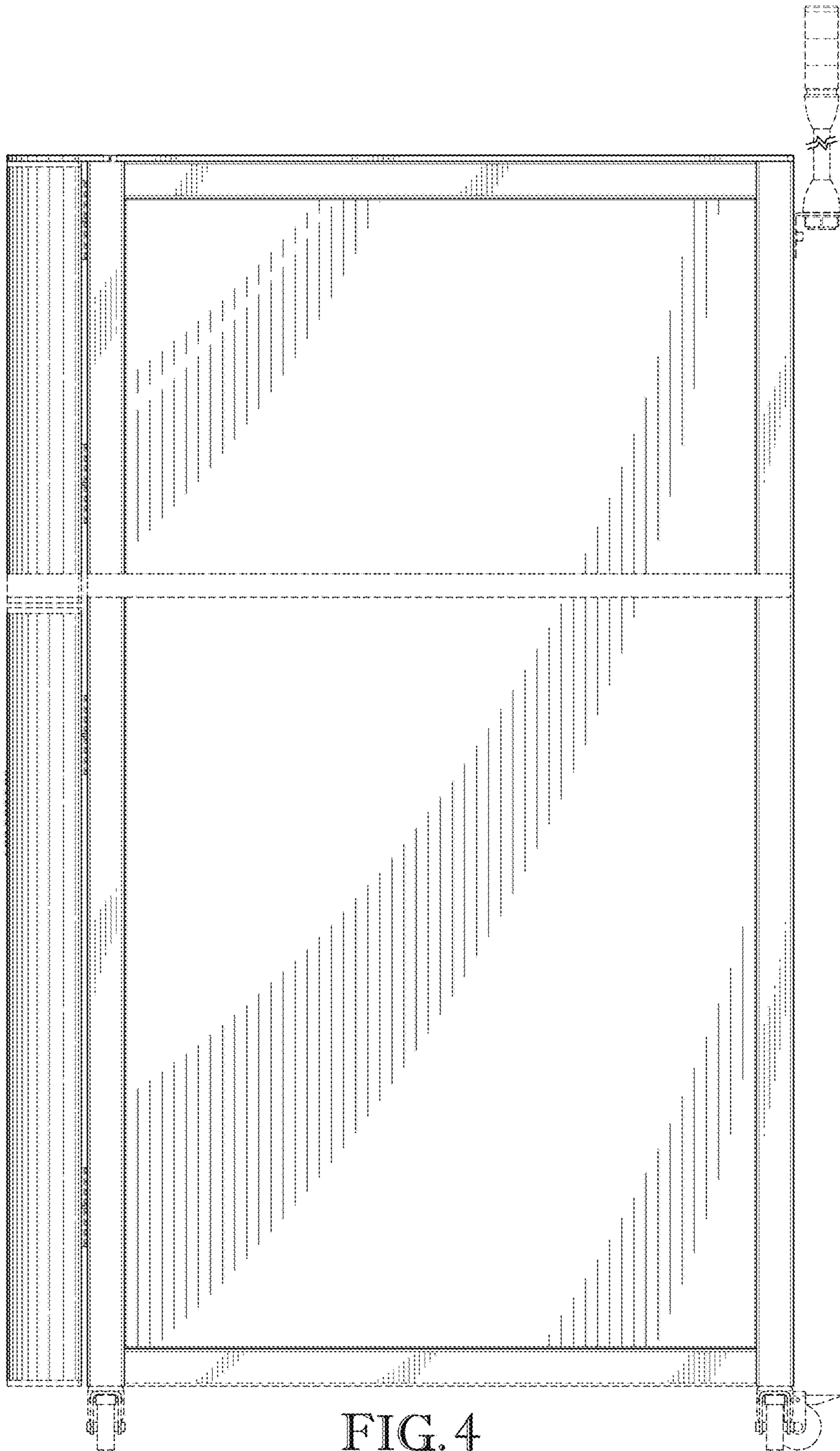

FIG. 4

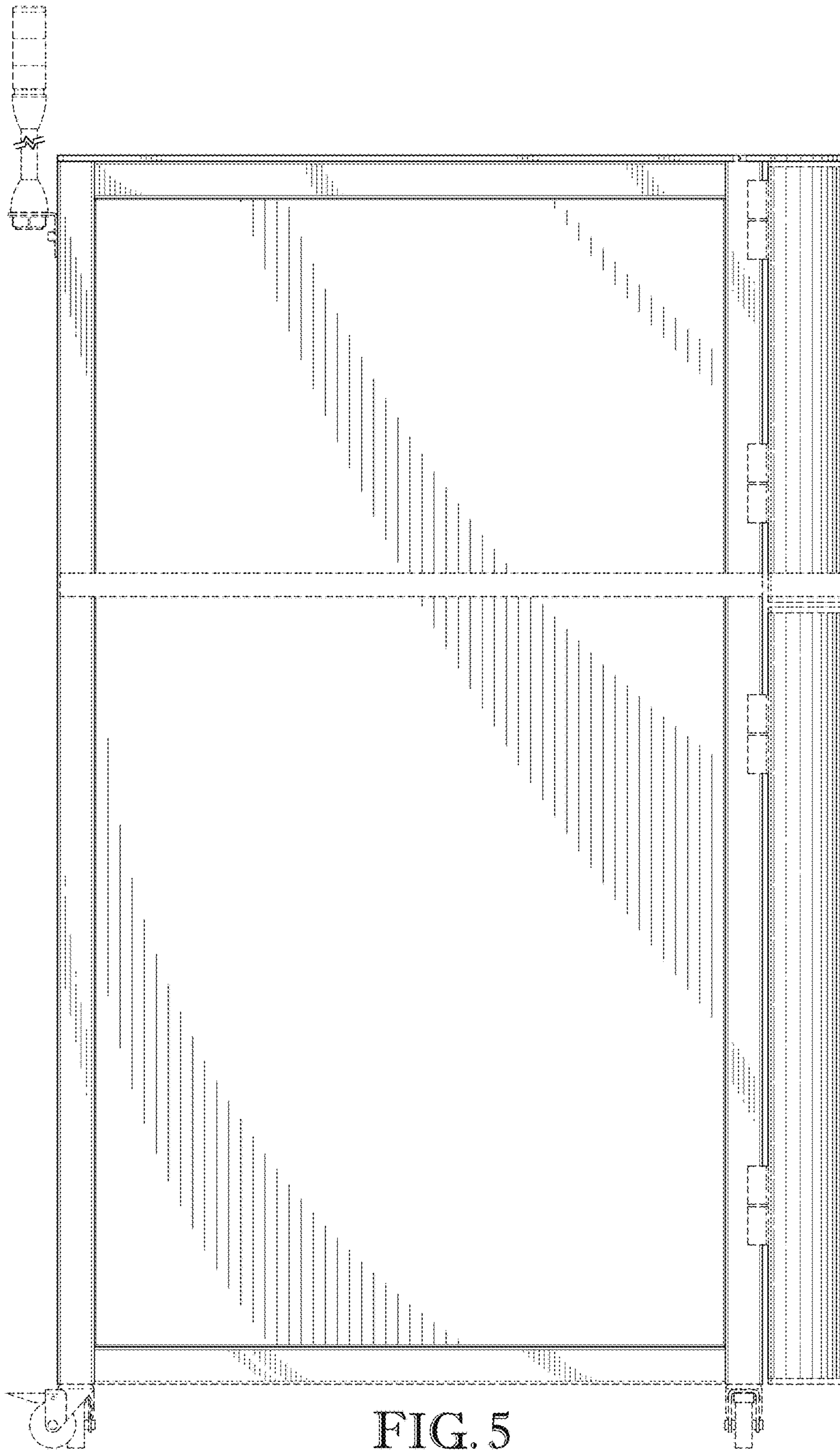

FIG. 5

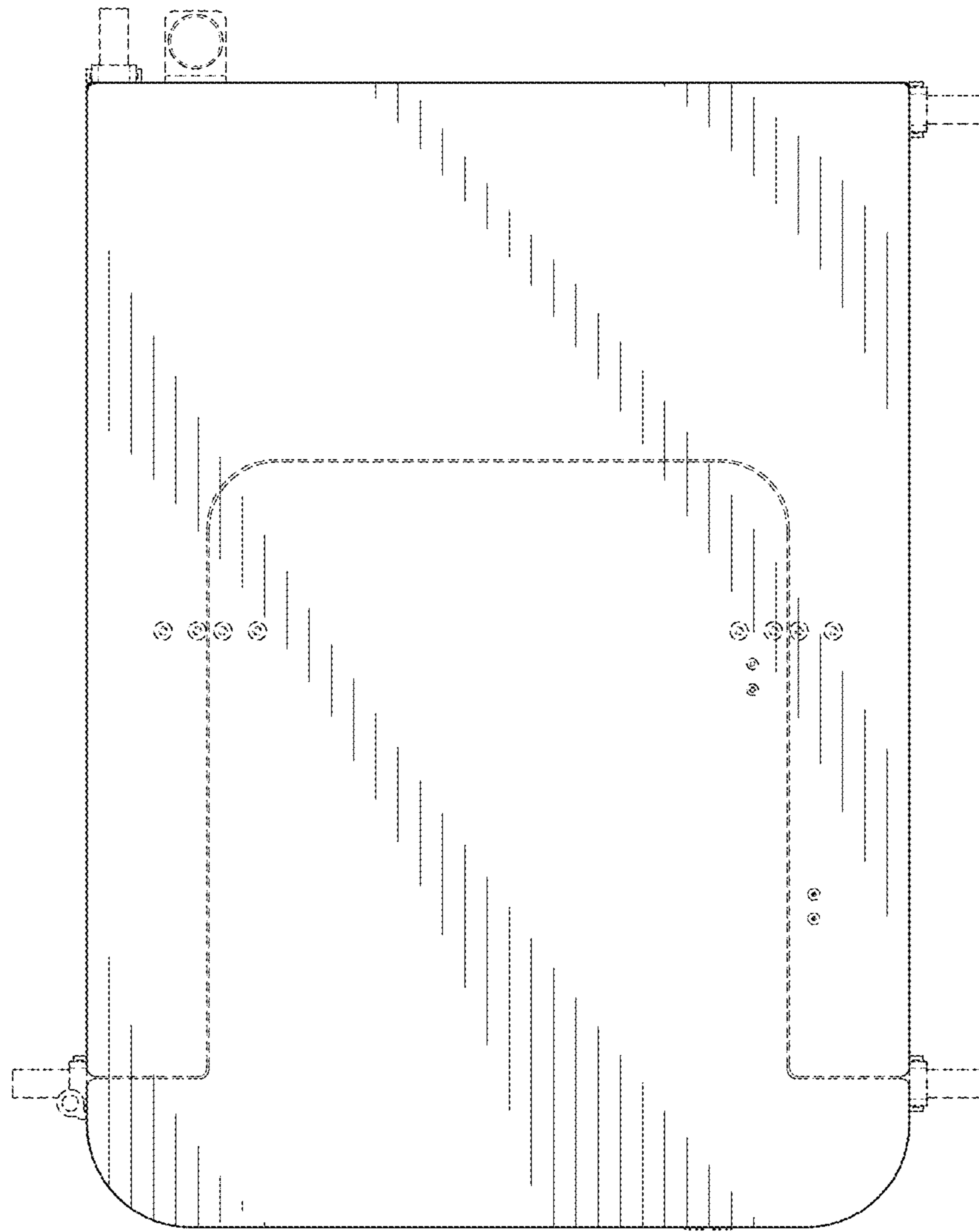

FIG. 6

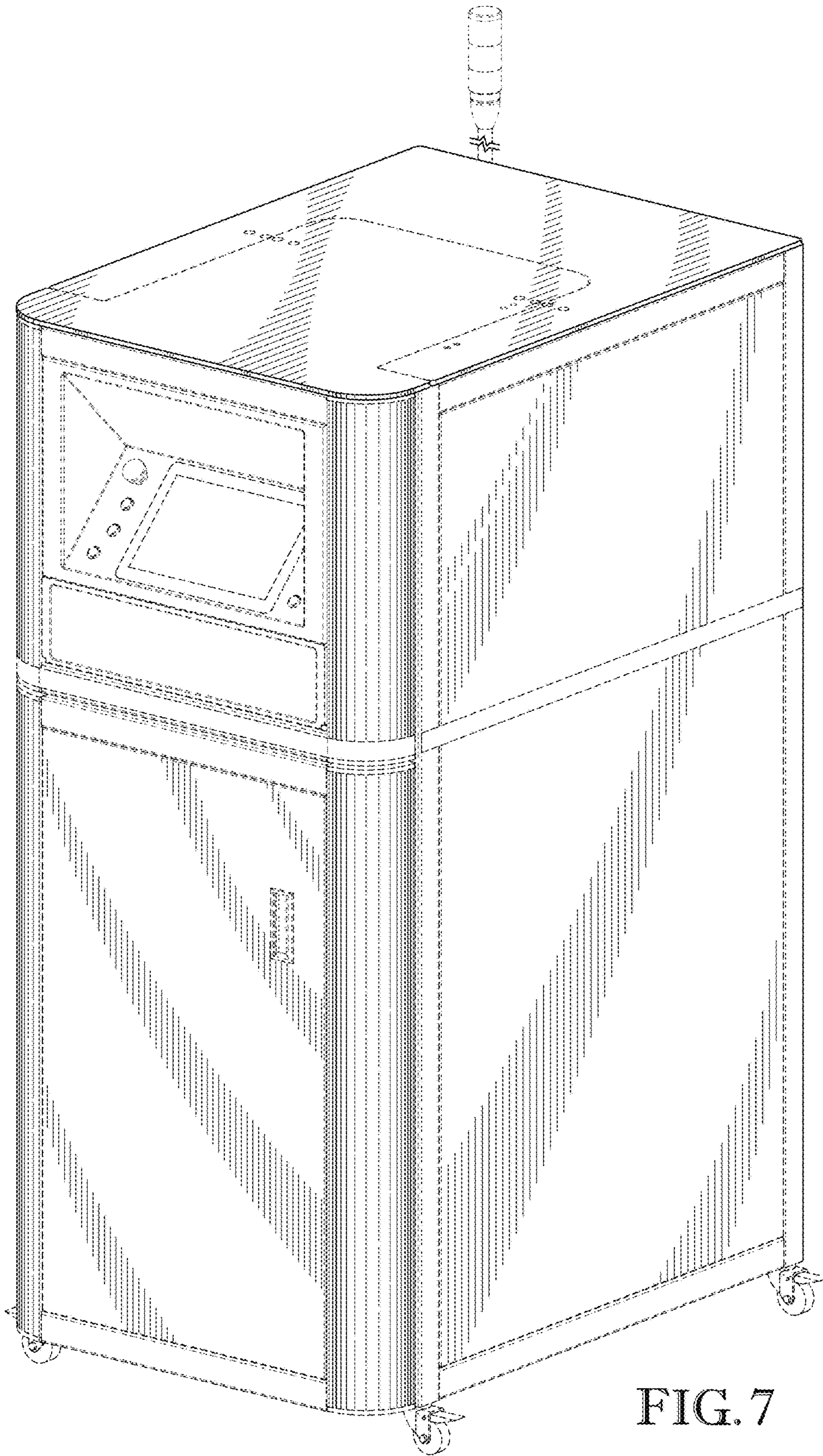

FIG. 7

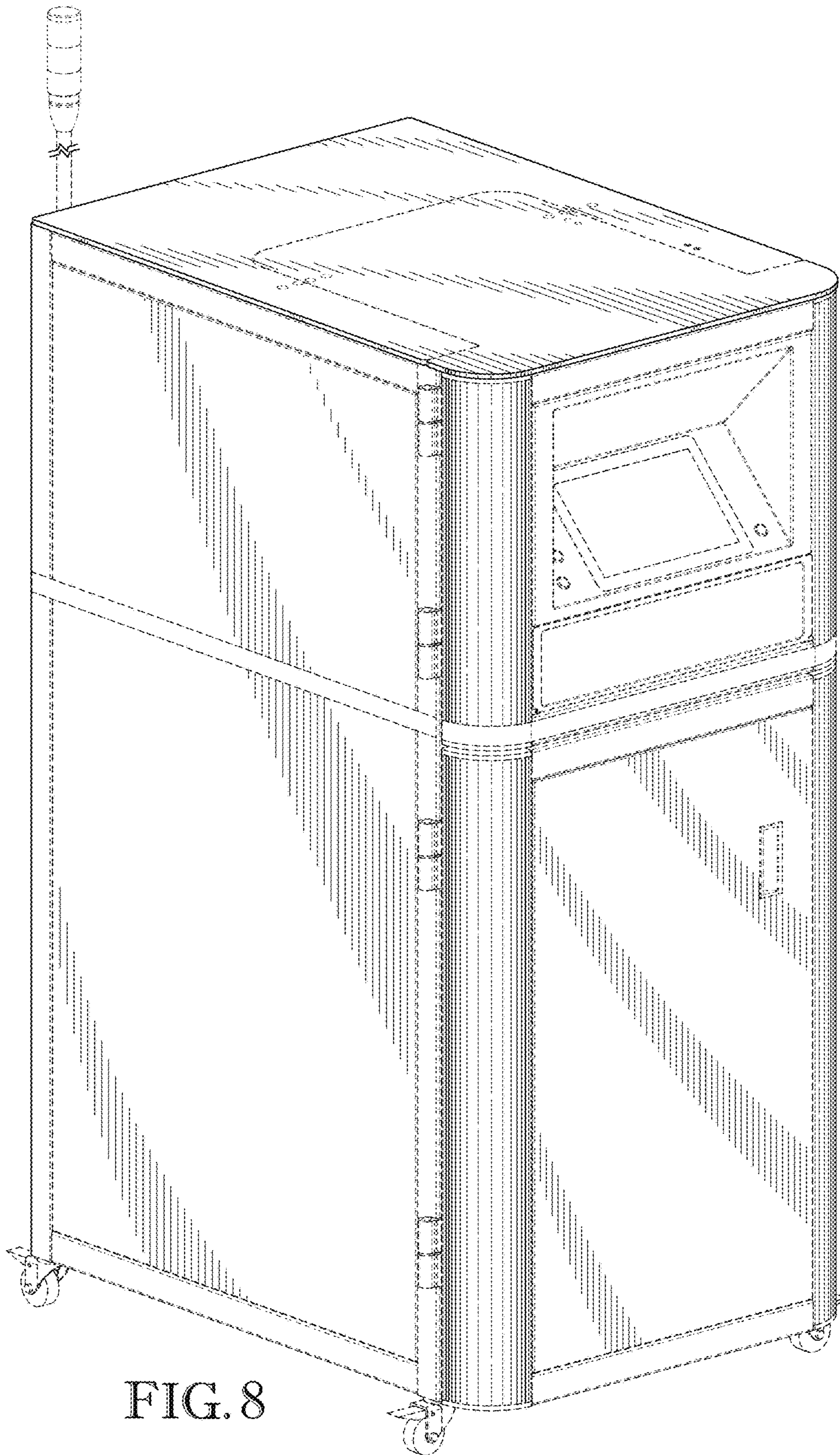

FIG. 8

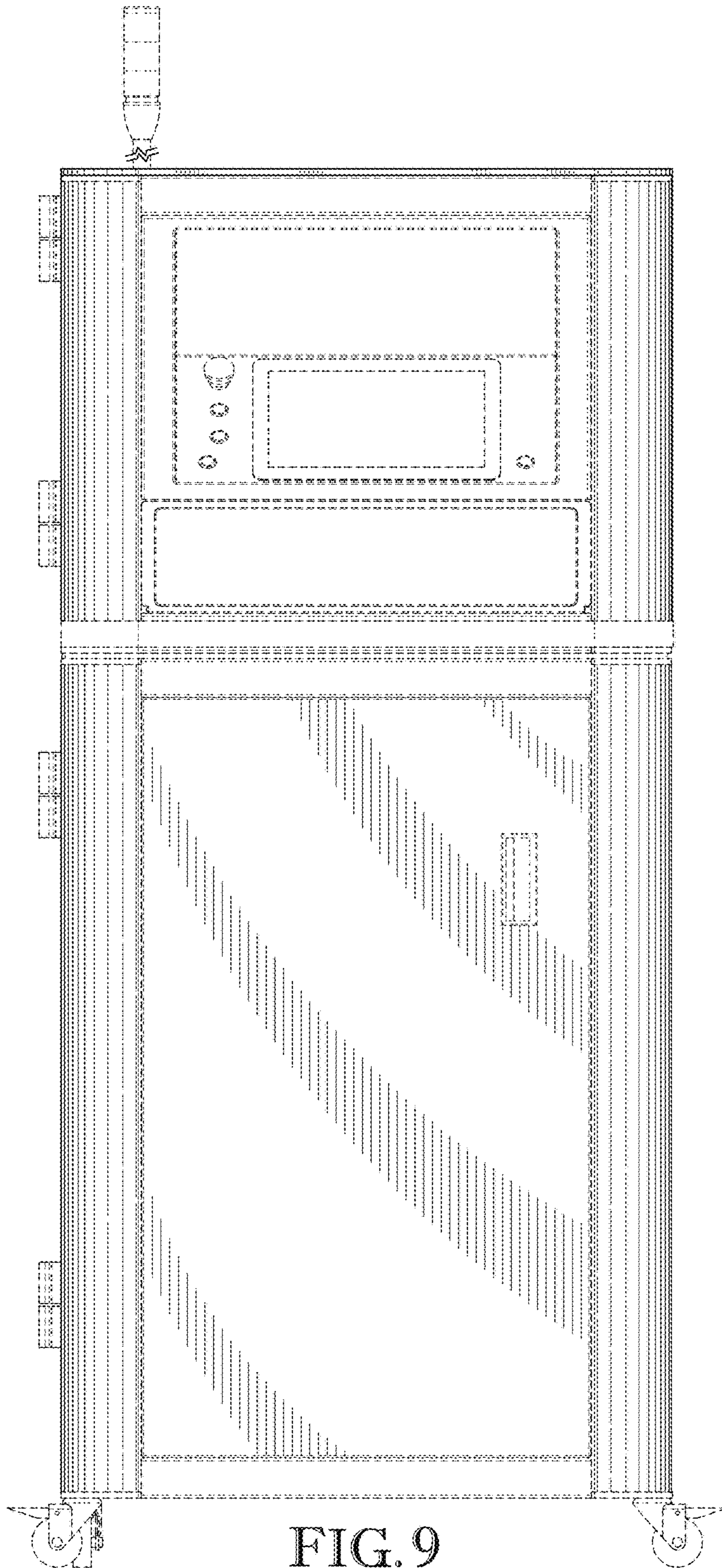

FIG. 9

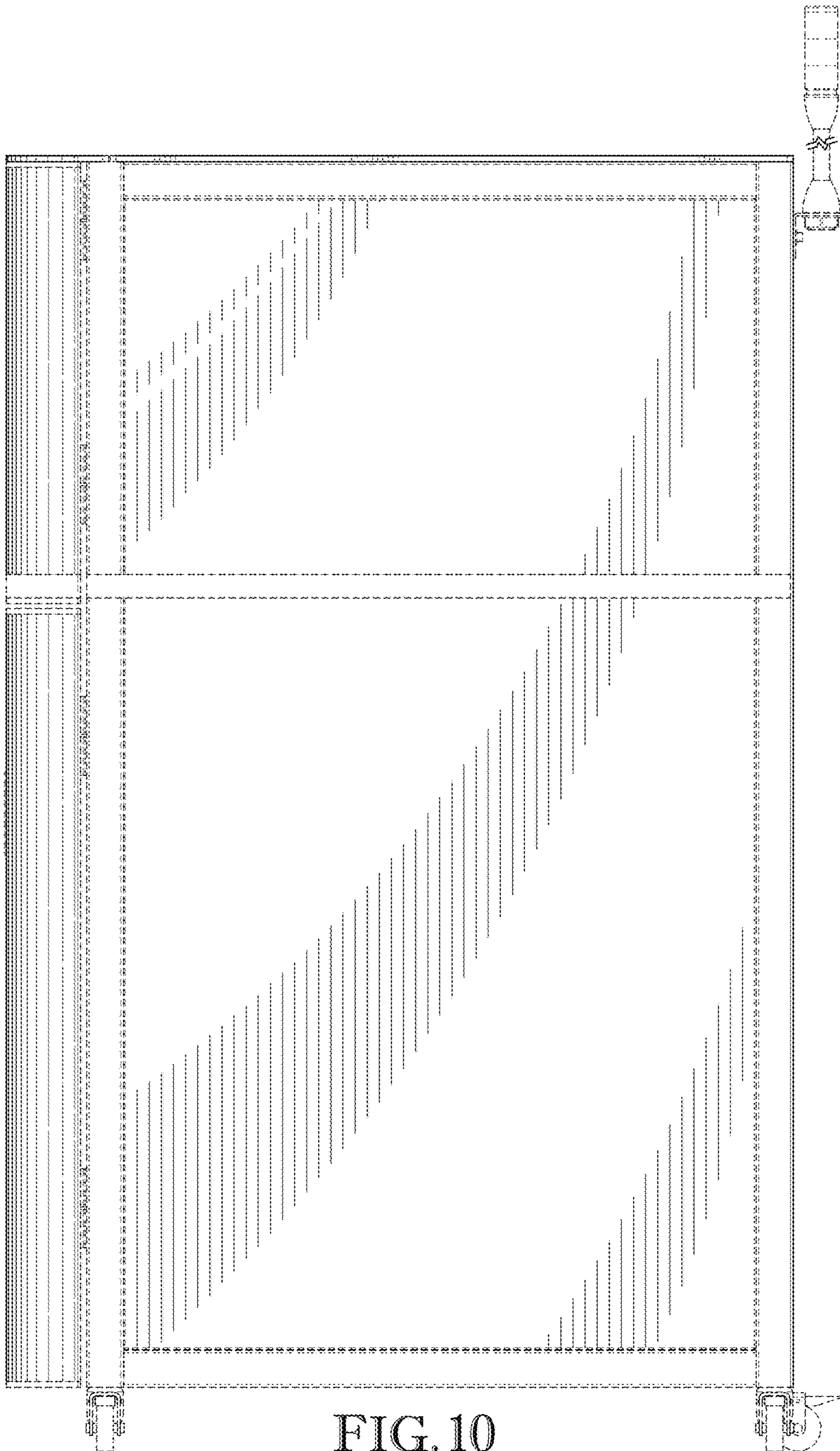

FIG. 10

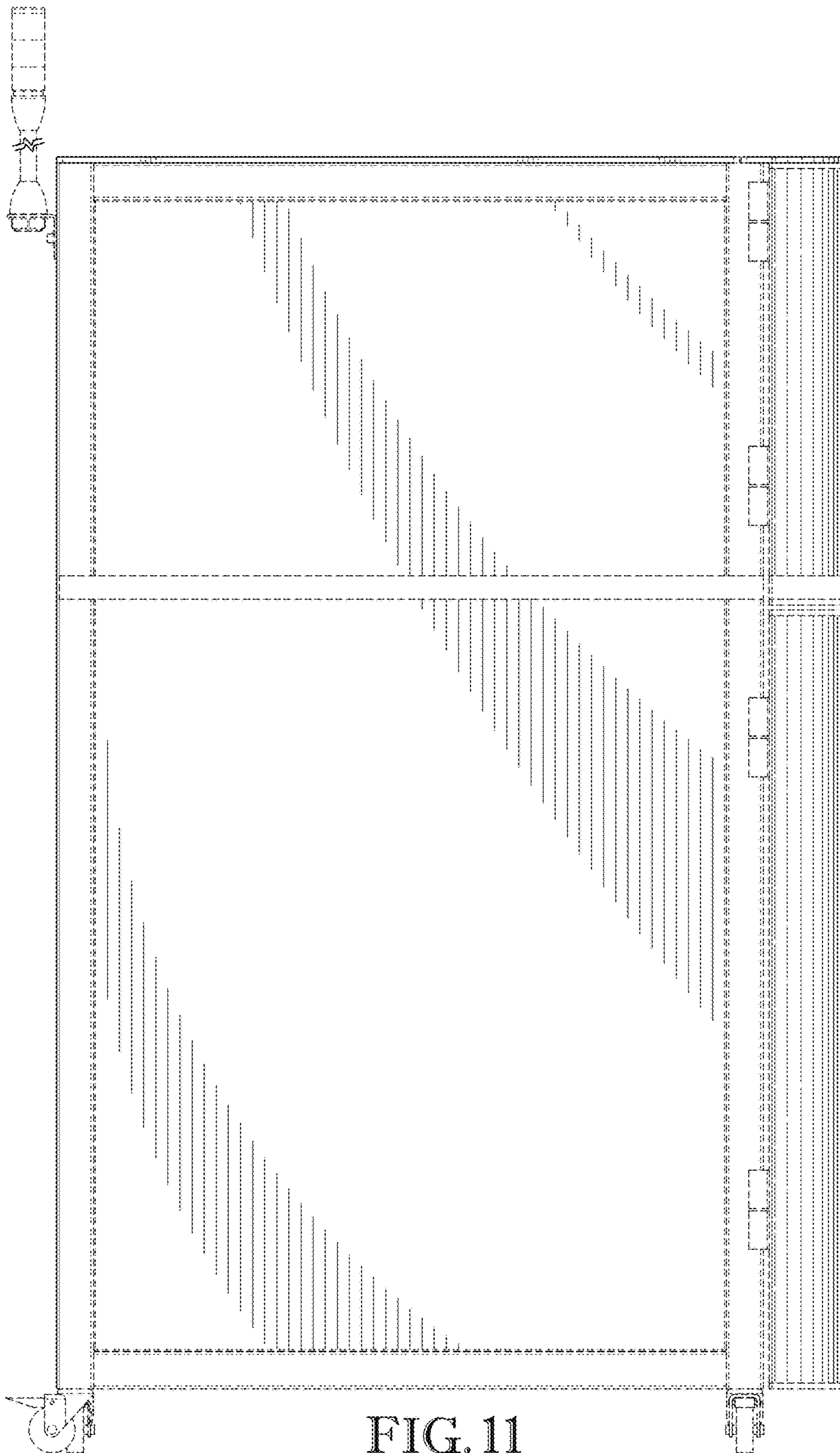

FIG. 11

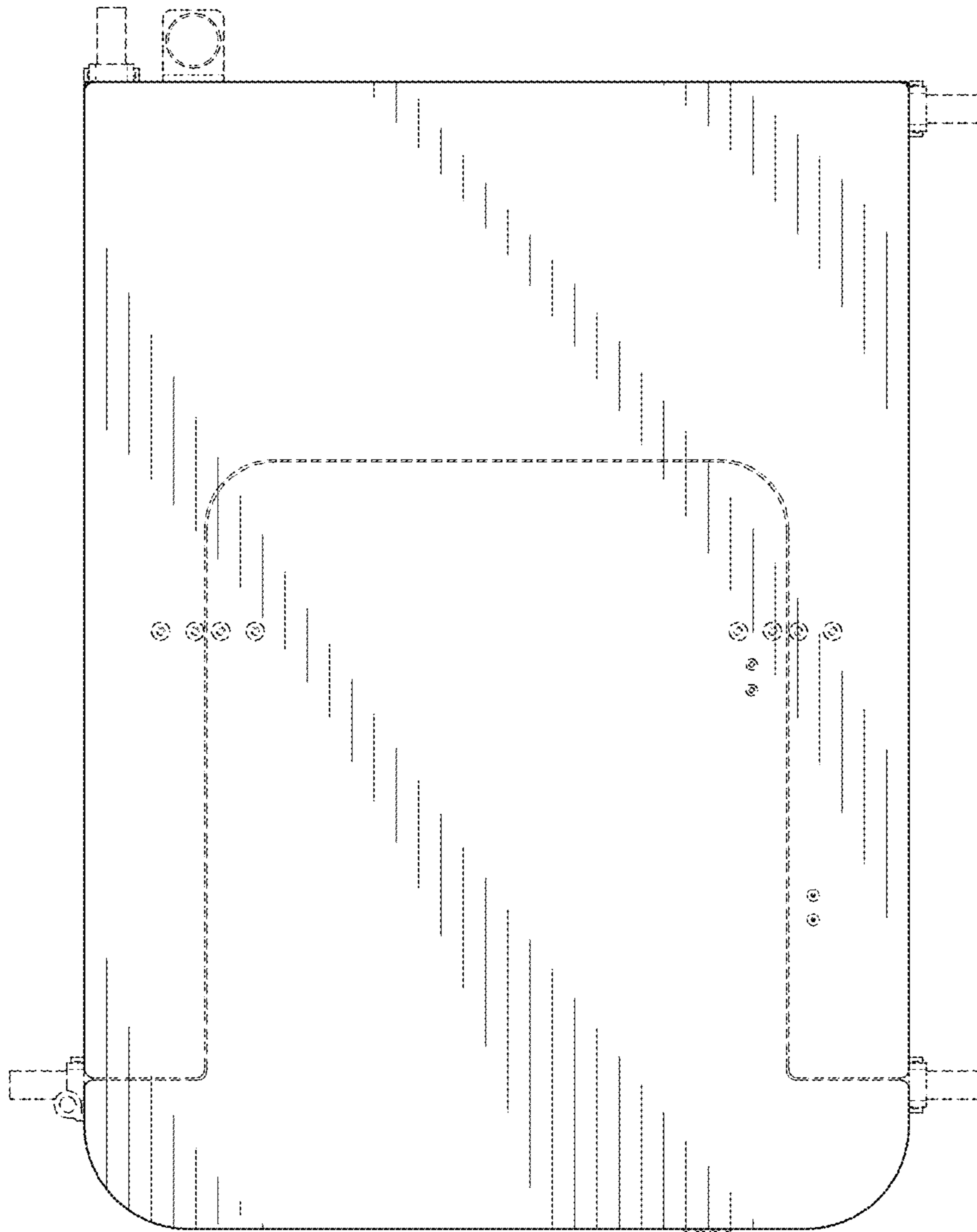

FIG. 12