



US00D815085S

(12) **United States Design Patent**
Kim

(10) **Patent No.:** **US D815,085 S**

(45) **Date of Patent:** **** Apr. 10, 2018**

(54) **CASE FOR ELECTRONIC DEVICES**

(71) Applicant: **Dae-Young Kim**, Seoul (KR)

(72) Inventor: **Dae-Young Kim**, Seoul (KR)

(73) Assignee: **SPIGEN KOREA CO., LTD.**,
Geumcheon-Gu, Seoul (KR)

(**) Term: **15 Years**

(21) Appl. No.: **29/604,286**

(22) Filed: **May 16, 2017**

Related U.S. Application Data

(63) Continuation of application No. 29/509,537, filed on
Nov. 18, 2014, now Pat. No. Des. 788,757.

(51) **LOC (11) Cl.** **14-03**

(52) **U.S. Cl.**
USPC **D14/250**

(58) **Field of Classification Search**

USPC D14/250–253, 440, 203.3–203.7, 217,
D14/496, 248, 238.1, 240, 447, 230, 247,
D14/341, 345, 346, 439; D3/201, 218,
D3/269, 301, 273, 303; D13/103,
D13/107–108

CPC . A45C 2011/002; A45C 11/00; A45C 13/002;
A45C 2011/003; H04M 1/0283; H04M
1/0202; H04M 1/185; H04B 1/3888

See application file for complete search history.

(56) **References Cited**

U.S. PATENT DOCUMENTS

D446,766 S 8/2001 Han
D620,003 S 7/2010 Chiang
D679,271 S 4/2013 Liu
D689,852 S 9/2013 Azoulay
D698,773 S 2/2014 Wildner
D706,254 S 6/2014 Chang
D710,342 S 8/2014 Fujimura

(Continued)

Primary Examiner — Sandra Snapp

Assistant Examiner — Holly E Thurman

(74) *Attorney, Agent, or Firm* — Heedong Chae; Lucem,
PC

(57) **CLAIM**

The ornamental design for a case for electronic devices, as
shown and described.

DESCRIPTION

FIG. 1 is a front perspective view of a case for electronic
devices showing my new design;

FIG. 2 is a rear perspective view thereof;

FIG. 3 is a front elevational view thereof;

FIG. 4 is a rear elevational view thereof;

FIG. 5 is a left side elevational view thereof;

FIG. 6 is a right side elevational view thereof;

FIG. 7 is a top plan view thereof;

FIG. 8 is a bottom plan view thereof;

FIG. 9 is a three-dimensional view of the case with a support
leg extended;

FIG. 10 is a three-dimensional exploded view of the case,
showing an inner shell, the support leg, and an outer frame
of the case;

FIG. 11 is a front perspective view of the inner shell of the
case;

FIG. 12 is a rear perspective view of the inner shell of the
case;

FIG. 13 is a front perspective view of the support leg of the
case;

FIG. 14 is a rear perspective view of the support leg of the
case;

FIG. 15 is a front perspective view of the outer frame of the
case; and,

FIG. 16 is a rear perspective view of the outer frame of the
case.

The broken line showing of environment is for illustrative
purposes only and forms no part of the claimed design.

1 Claim, 16 Drawing Sheets

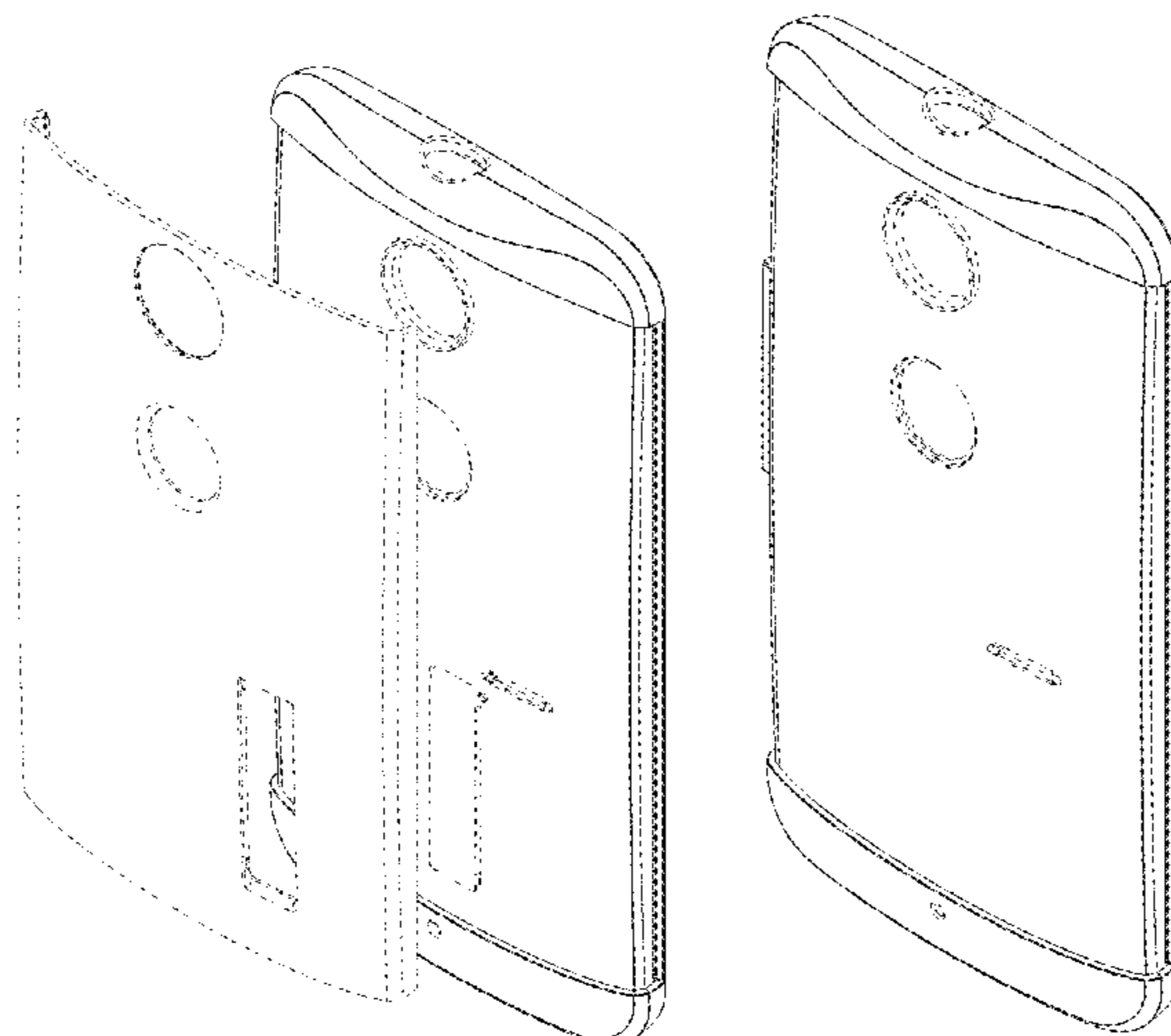

(56)

References Cited

U.S. PATENT DOCUMENTS

D712,861 S 9/2014 Fujimura
 D712,888 S 9/2014 Fujimura
 D714,272 S 9/2014 Park
 D724,572 S 3/2015 Wildner
 D732,498 S 6/2015 Huang
 D732,515 S 6/2015 Kim
 D736,754 S 8/2015 Morgenroth
 D737,815 S 9/2015 Finney
 D739,391 S 9/2015 Chen
 D741,279 S 10/2015 Tai
 D760,709 S 7/2016 Chen et al.
 D761,776 S 7/2016 Choe et al.
 D763,241 S 8/2016 Kim
 D763,242 S 8/2016 Kim
 D770,434 S 11/2016 Choe et al.
 D778,274 S 2/2017 Lim et al.

D778,897 S * 2/2017 Kim D14/250
 D783,587 S 4/2017 Kim
 D785,588 S * 5/2017 Boucquey D14/138 G
 D786,851 S * 5/2017 Kim D14/250
 D786,852 S * 5/2017 Kim D14/250
 D786,854 S * 5/2017 Kim D14/250
 D787,492 S * 5/2017 Kim D14/250
 D788,727 S * 6/2017 Kuo D14/138 G
 D788,753 S 6/2017 Kim et al.
 D788,757 S * 6/2017 Kim D14/250
 D789,344 S * 6/2017 Kim D14/250
 D791,755 S * 7/2017 Kim D14/250
 D794,590 S * 8/2017 Pierce D14/138 G
 D796,497 S * 9/2017 Kim D14/250
 D797,094 S * 9/2017 Kim D14/250
 2014/0085777 A1 3/2014 Yeh
 2014/0262855 A1 9/2014 Gandhi
 2014/0284096 A1 9/2014 Wu

* cited by examiner

FIG. 1

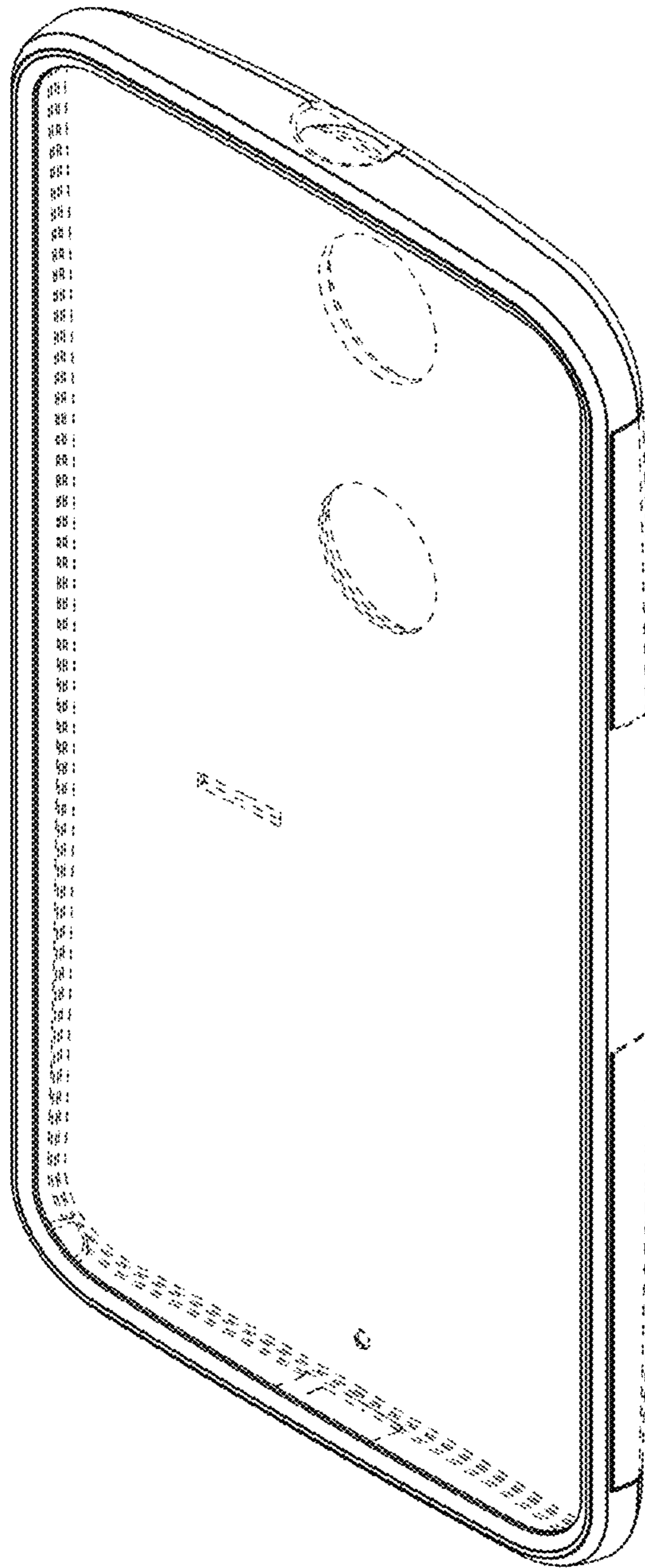

FIG. 2

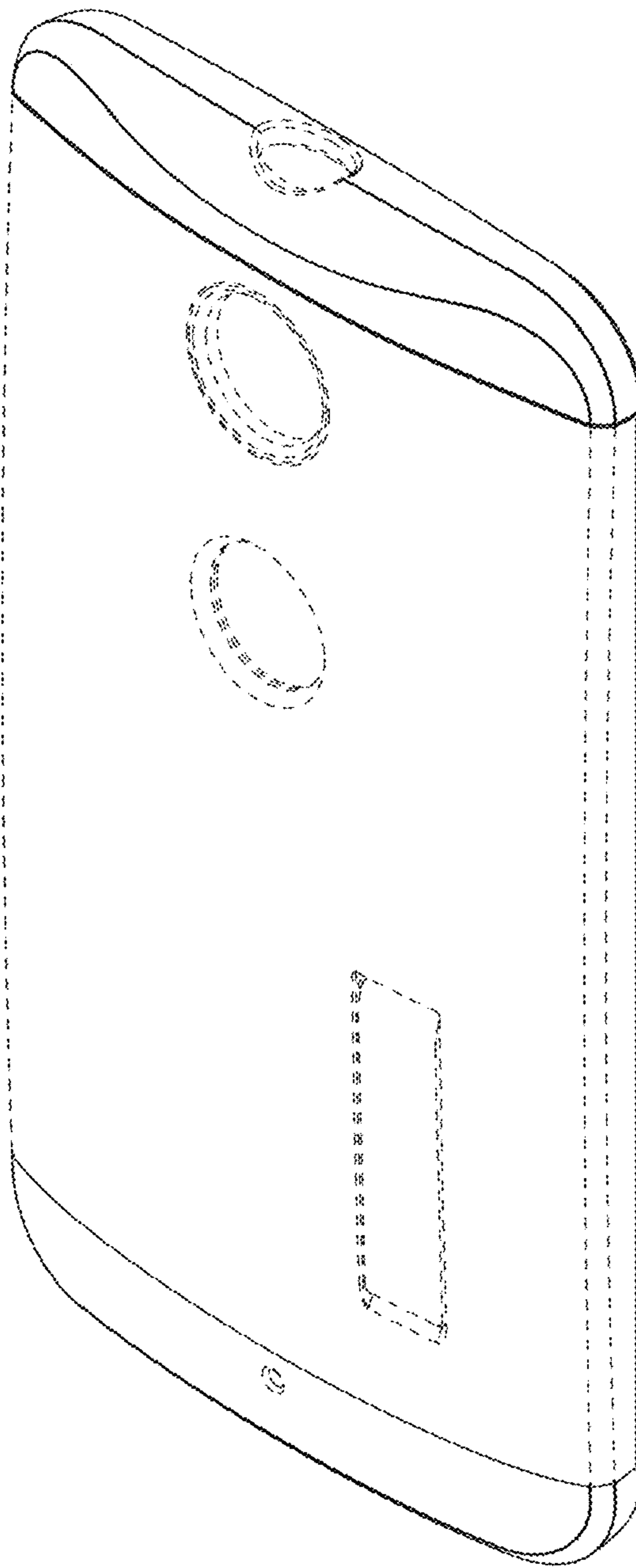

FIG. 3

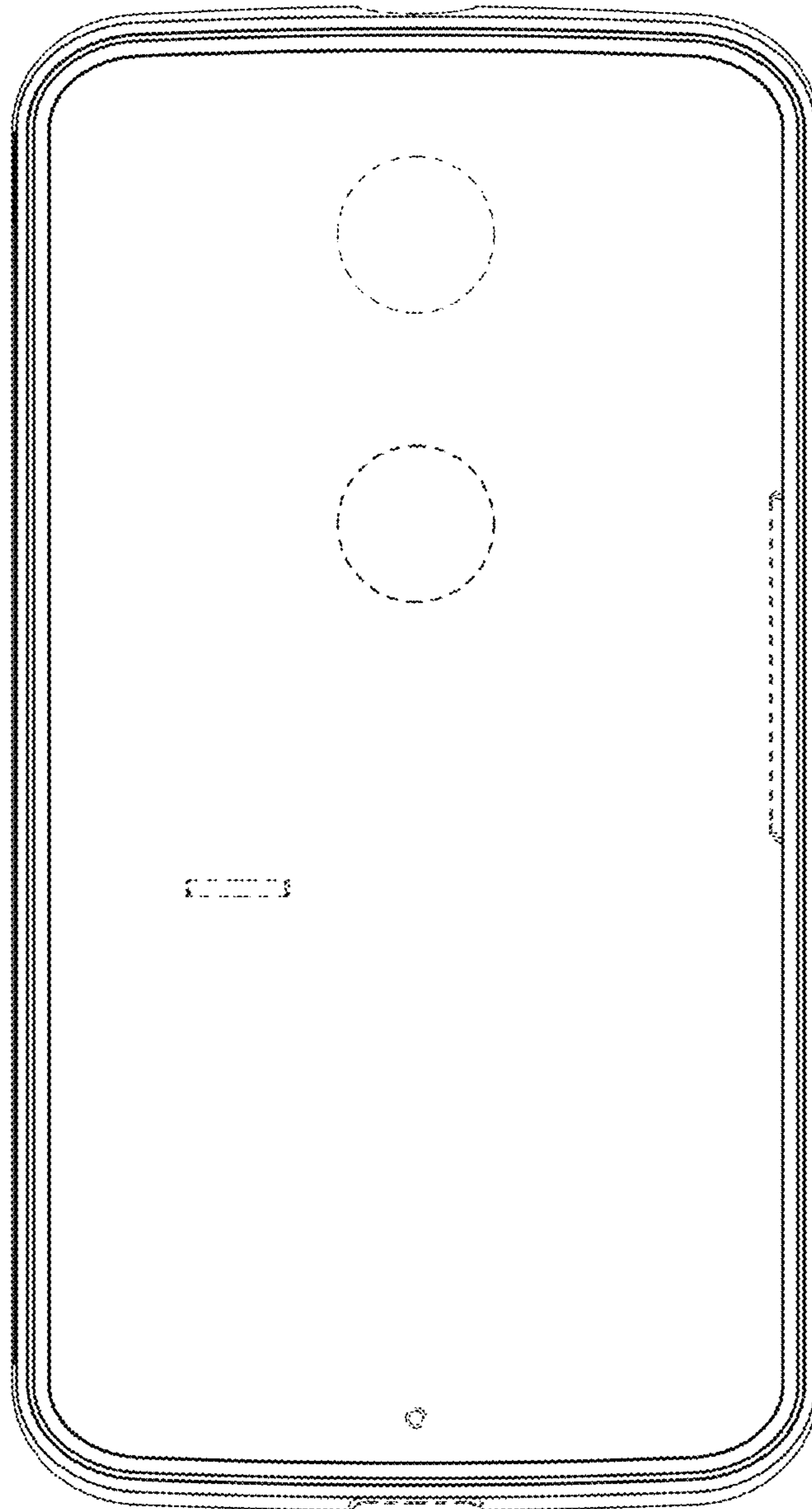

FIG. 4

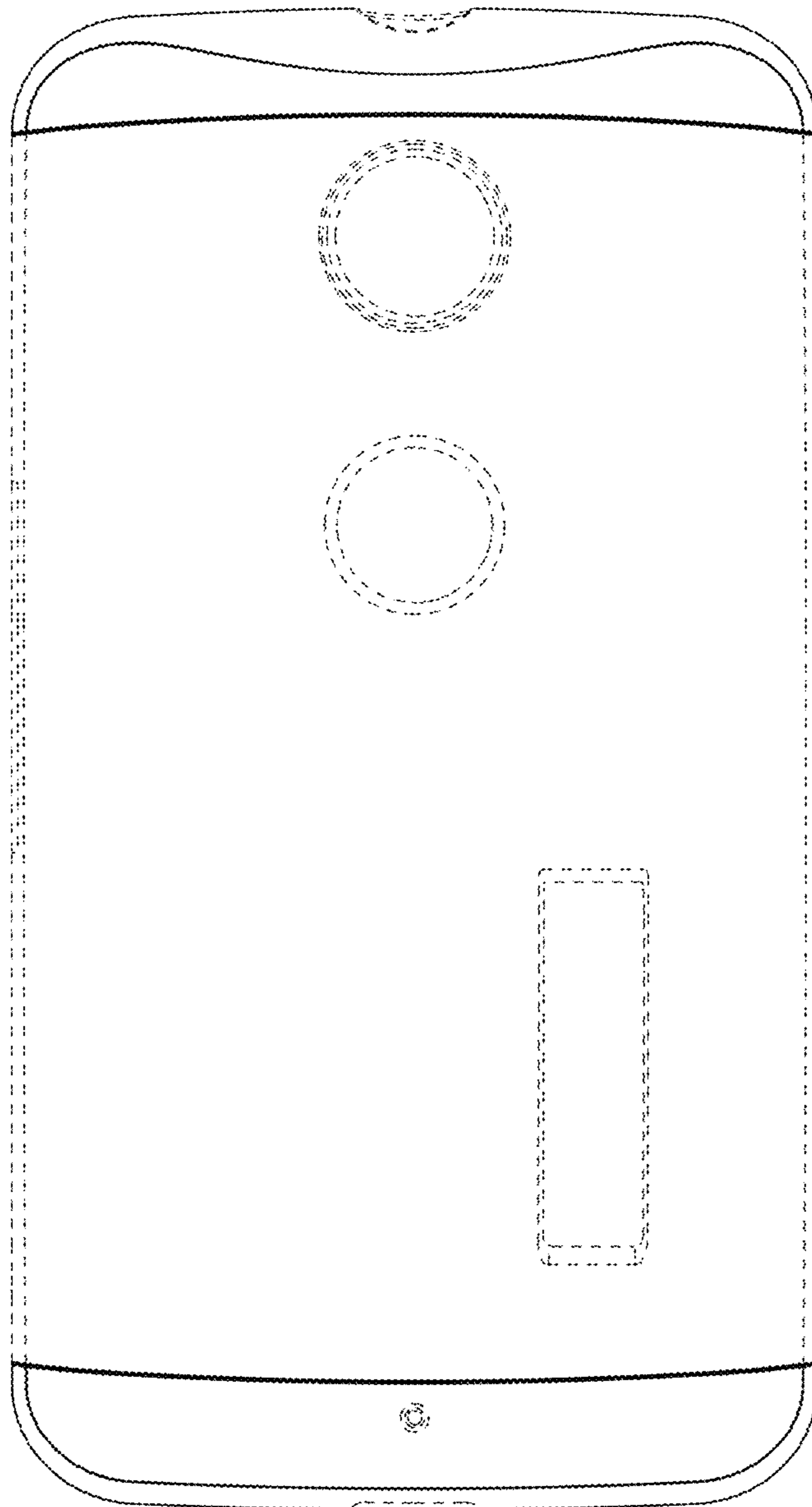

FIG. 5

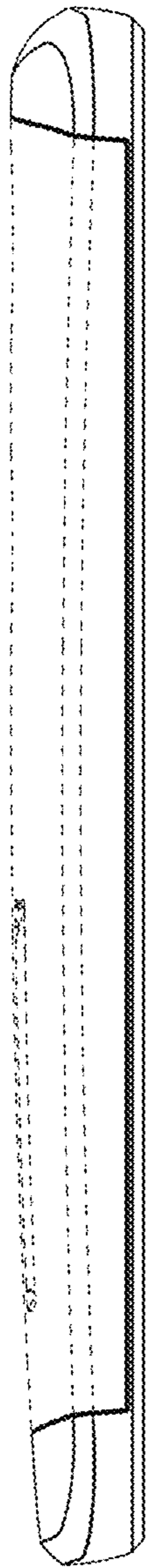

FIG. 6

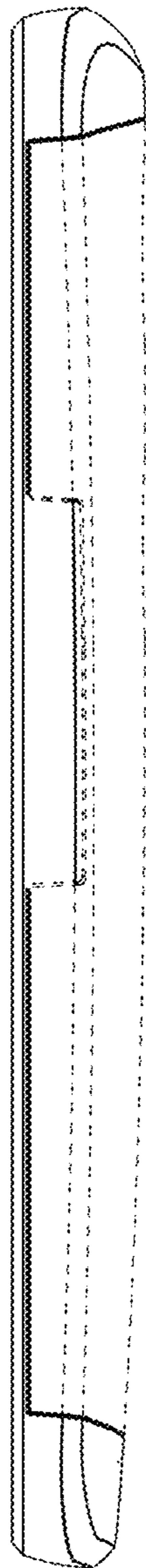

FIG. 7

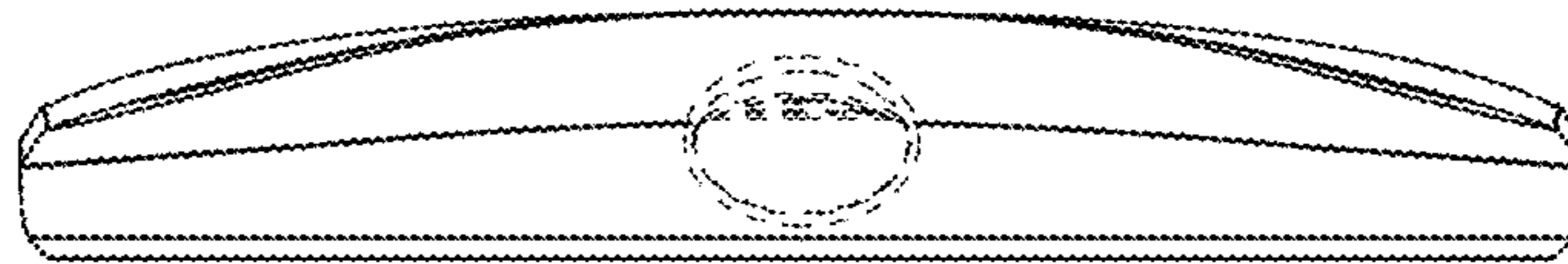

FIG. 8

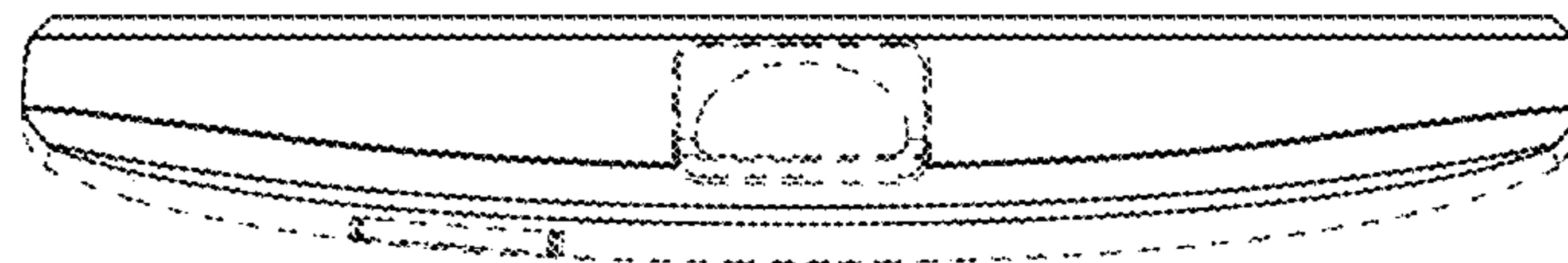

FIG. 9

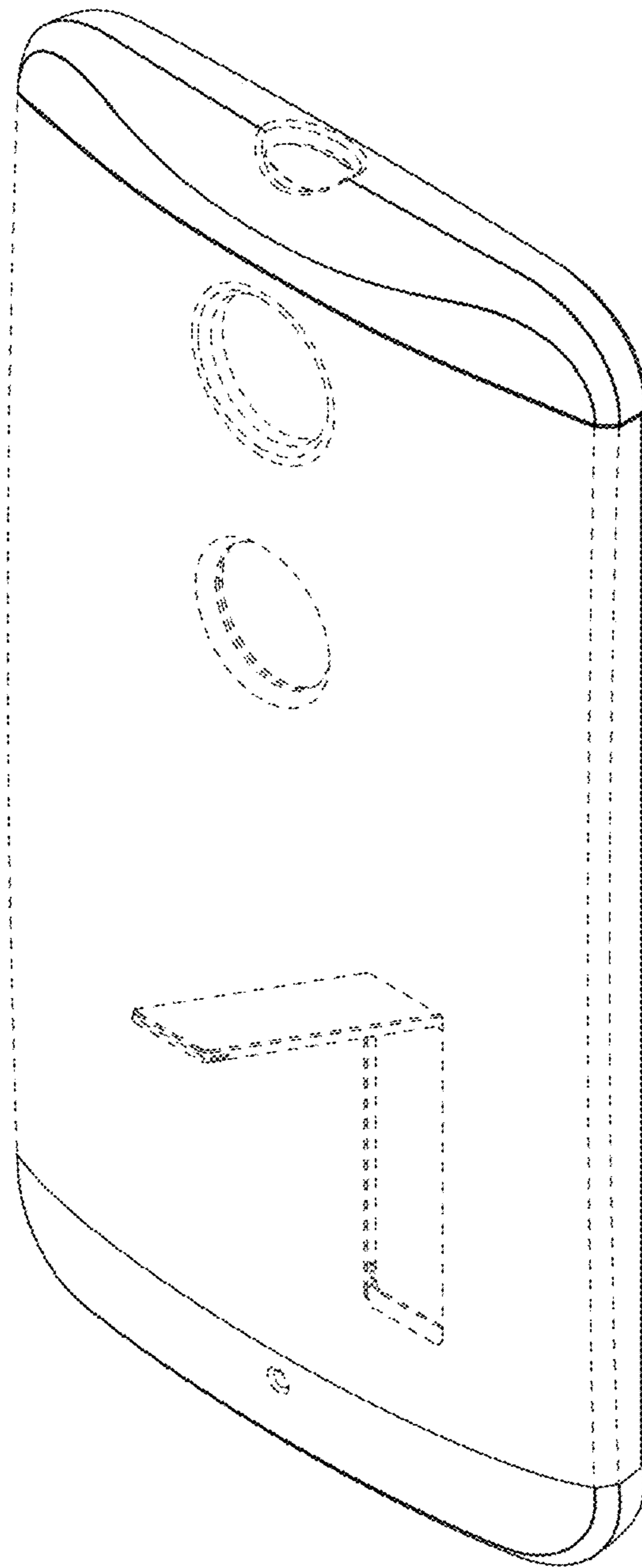

FIG. 10

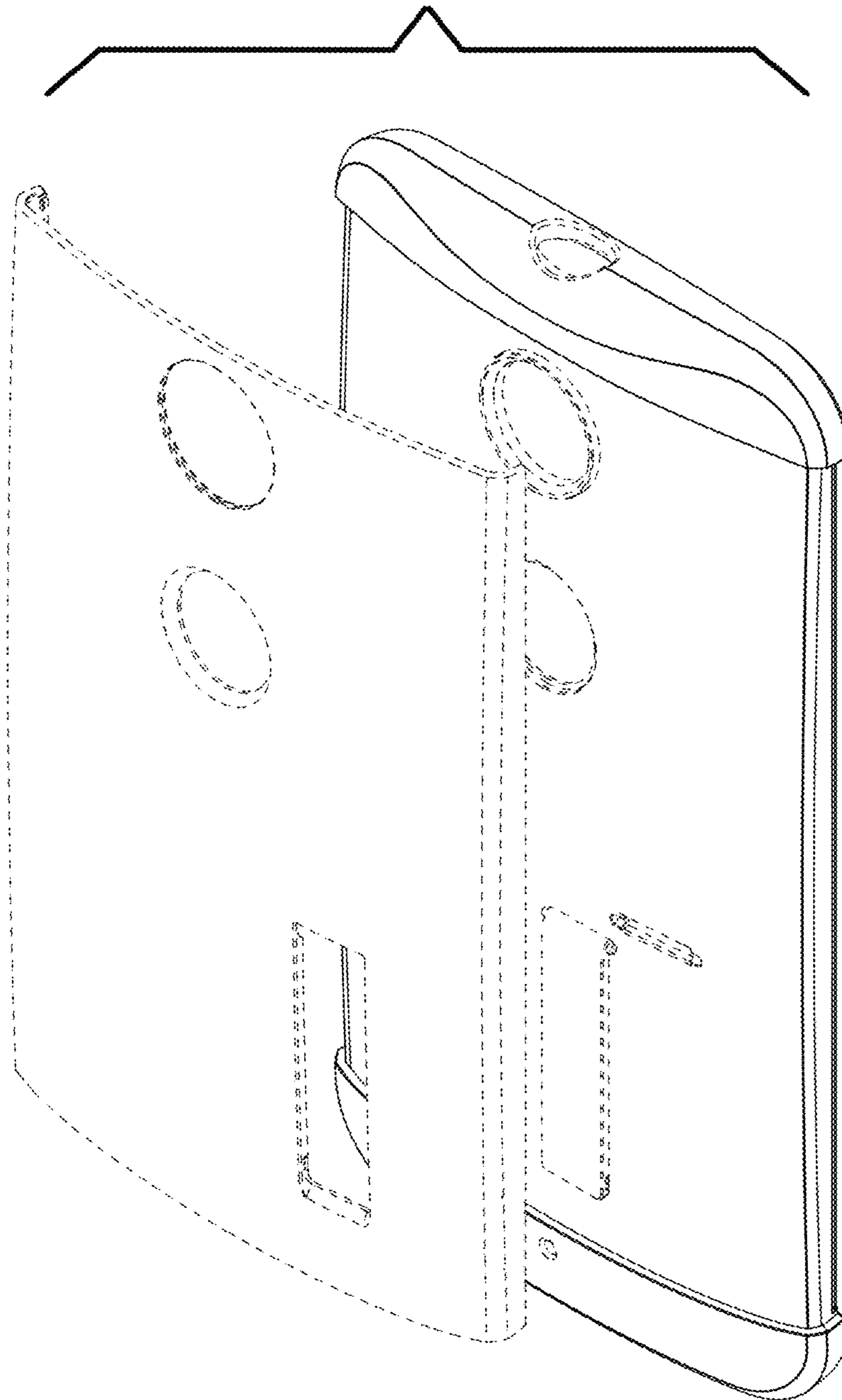

FIG. 11

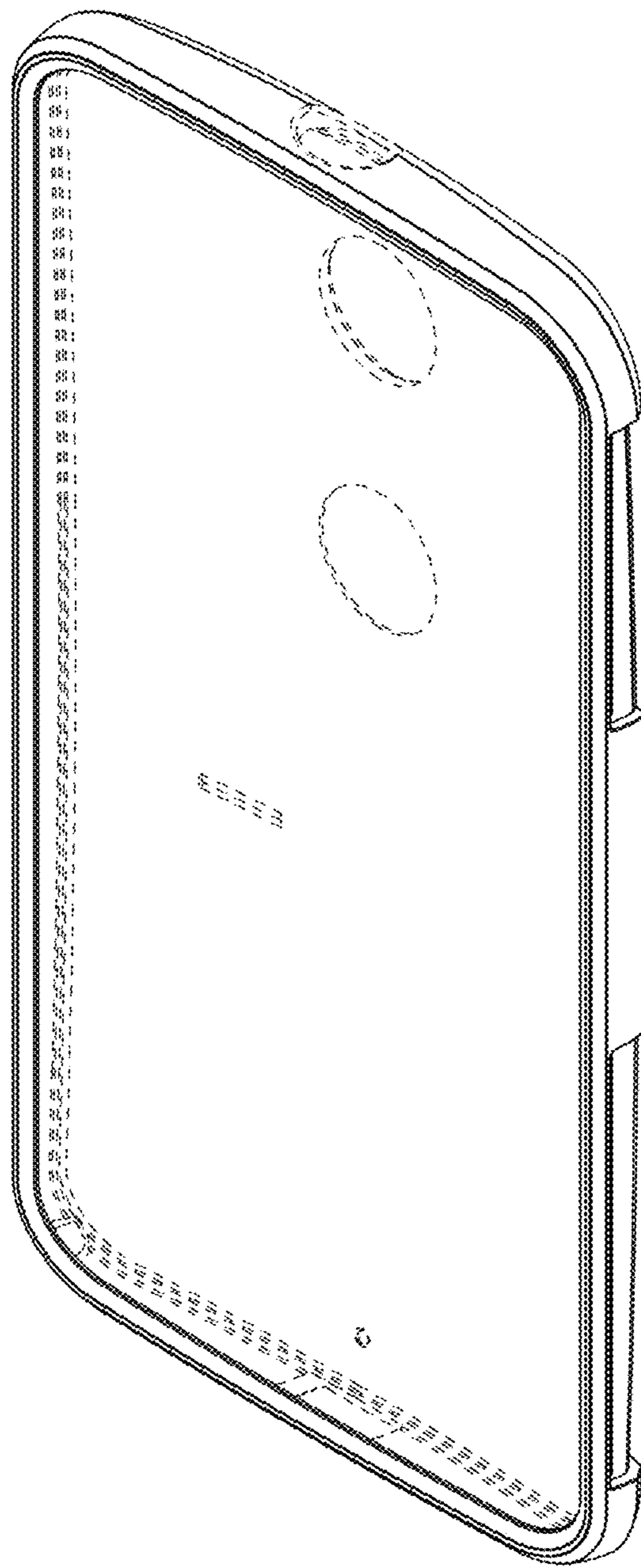

FIG. 12

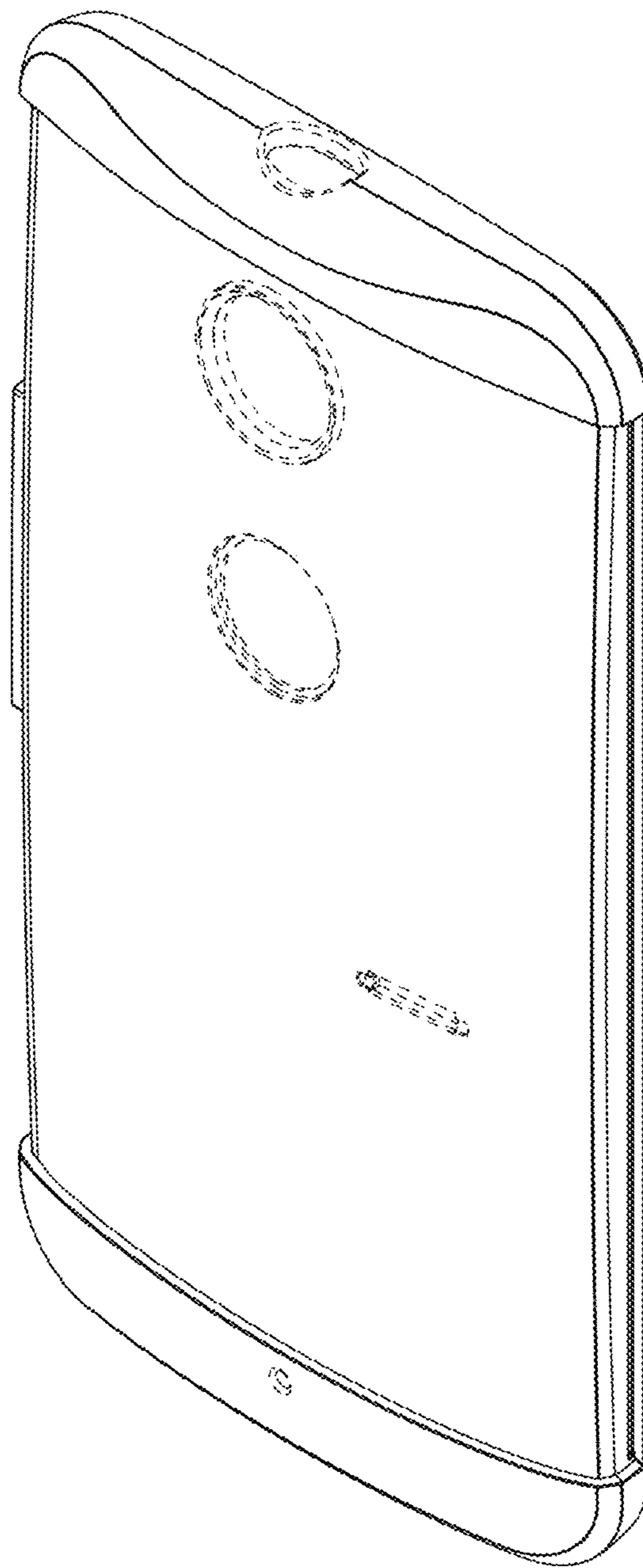

FIG. 13

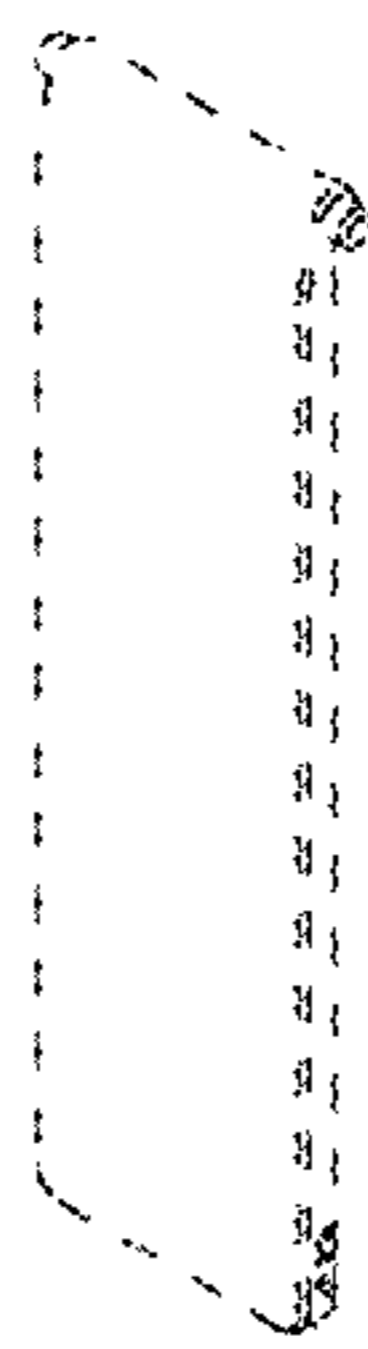

FIG. 14



FIG. 15

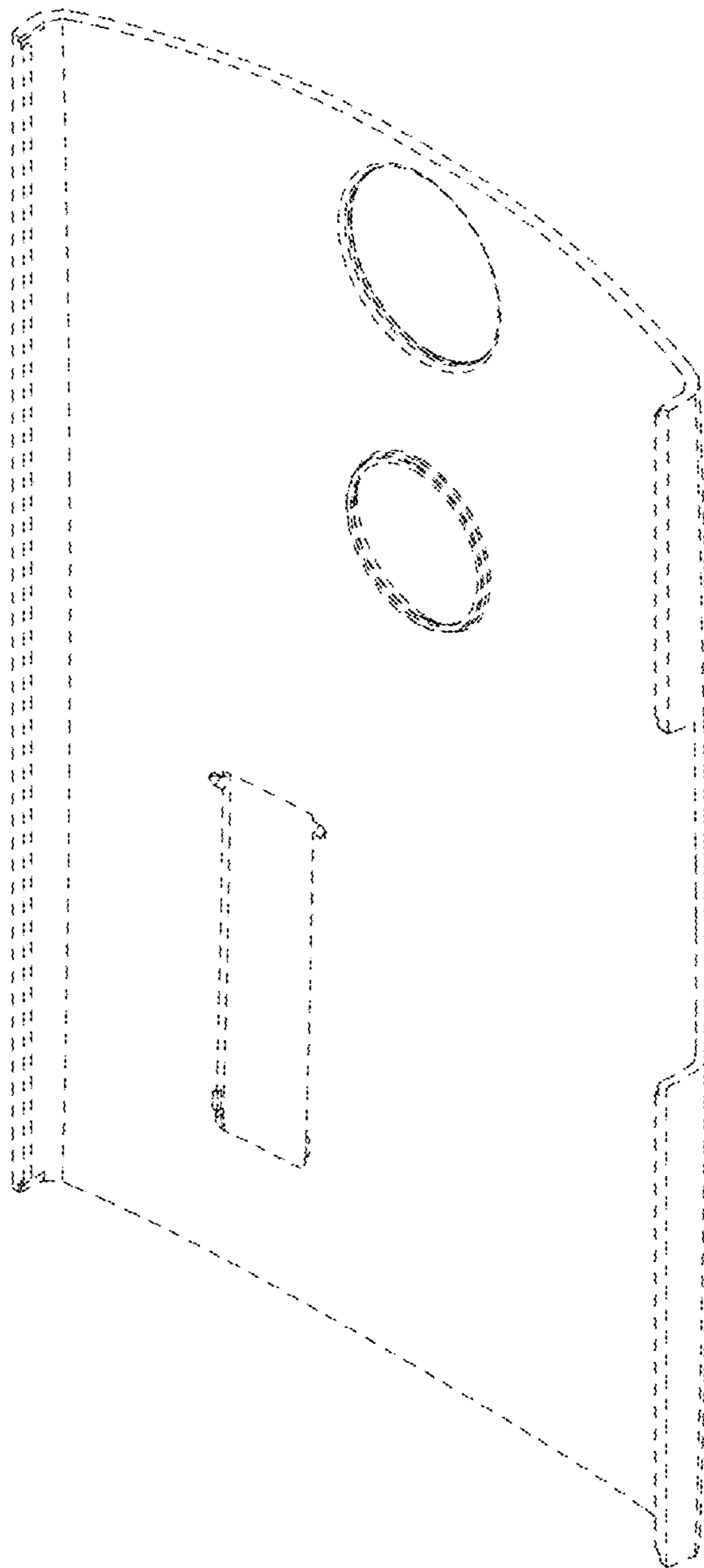

FIG. 16

