



US00D814958S

(12) **United States Design Patent** (10) **Patent No.:** **US D814,958 S**
Silvestri (45) **Date of Patent:** **** Apr. 10, 2018**

(54) **ARTICLE OF JEWELRY**
(71) Applicant: **Bulgari S.p.A.**, Rome (IT)
(72) Inventor: **Lucia Silvestri**, Rome (IT)
(73) Assignee: **BULGARI S.P.A.**, Rome (IT)
(**) Term: **15 Years**
(21) Appl. No.: **29/572,938**
(22) Filed: **Aug. 1, 2016**
(30) **Foreign Application Priority Data**
Feb. 1, 2016 (WO) DM089490

D169,675 S * 5/1953 Katz D11/4
D170,995 S * 12/1953 Katz D11/4
D172,750 S * 8/1954 Katz D11/5
D186,818 S * 12/1959 Gale D11/2
D190,753 S * 6/1961 Brauchi D11/5
D259,029 S * 4/1981 Barr D11/28
4,282,721 A * 8/1981 Roach A44C 7/00
D11/28
D342,916 S * 1/1994 Giralt D11/26
D445,354 S * 7/2001 Haquet D11/3
D445,713 S * 7/2001 Haquet D11/3
D445,714 S * 7/2001 Haquet D11/3
D454,515 S * 3/2002 Gruosi D11/34
D562,172 S * 2/2008 Yuengling D11/4
D653,149 S * 1/2012 Behar D11/5
D720,644 S * 1/2015 Yatsugi-Kang D11/34
D794,013 S * 8/2017 Heck D11/5
2010/0071413 A1 * 3/2010 Shamlan A44C 5/0007
63/1.12

(51) **LOC (11) Cl.** **11-01**
(52) **U.S. Cl.**
USPC **D11/4**
(58) **Field of Classification Search**
USPC D11/1-18, 26, 27, 28, 29, 30, 31, 34;
D28/41
CPC A44C 5/00; A44C 5/0007; A44C 5/0046;
A44C 5/0053; A44C 5/0061; A44C
5/0069; A44C 5/0076; A44C 5/0084;
A44C 5/0092; A44C 5/02; A44C 5/022;
A44C 5/025; A44C 5/027; A44C 5/04;
A44C 5/10; A44C 5/102; A44C 5/105;
A44C 5/107; A44C 5/12; A44C 9/0007;
A44C 9/0038; A44C 9/0046; A44C
9/0053; A44C 9/0061; A44C 9/0076;
A44C 9/0084; A44C 9/0092; A44C 9/02;
A44C 1/00; A44C 3/00; A44C 3/004;
A44C 3/005; A44C 13/00; A44C 17/02;
A44C 17/04; A44C 17/046; A44C 7/00;
A44C 7/003
See application file for complete search history.

* cited by examiner
Primary Examiner — Cynthia Ramirez
Assistant Examiner — L. Martinez-Rivera
(74) *Attorney, Agent, or Firm* — Stephen Kenny; Peter Sullivan; Foley Hoag LLP

(56) **References Cited**
U.S. PATENT DOCUMENTS
D140,369 S * 2/1945 Rose D11/31
D150,867 S * 9/1948 Katz D11/14

(57) **CLAIM**
The ornamental design for an article of jewelry, as shown and described.

DESCRIPTION
FIG. 1 is a perspective view of an article of jewelry showing my new design.
FIG. 2 is a front view thereof.
FIG. 3 is a back view thereof.
FIG. 4 is a left view thereof.
FIG. 5 is a right view thereof.
FIG. 6 is a top view thereof; and,
FIG. 7 is a bottom view thereof.

1 Claim, 7 Drawing Sheets

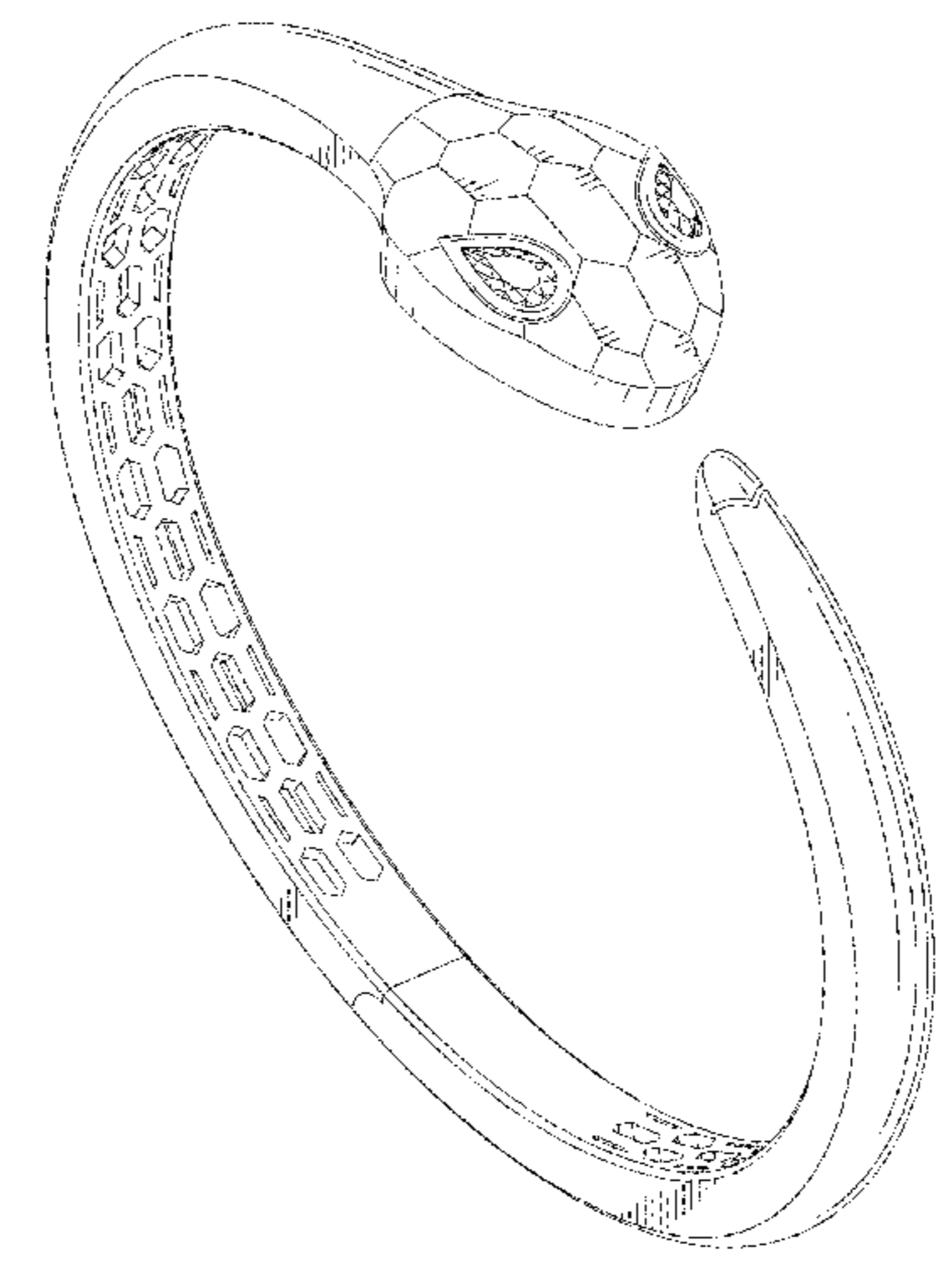

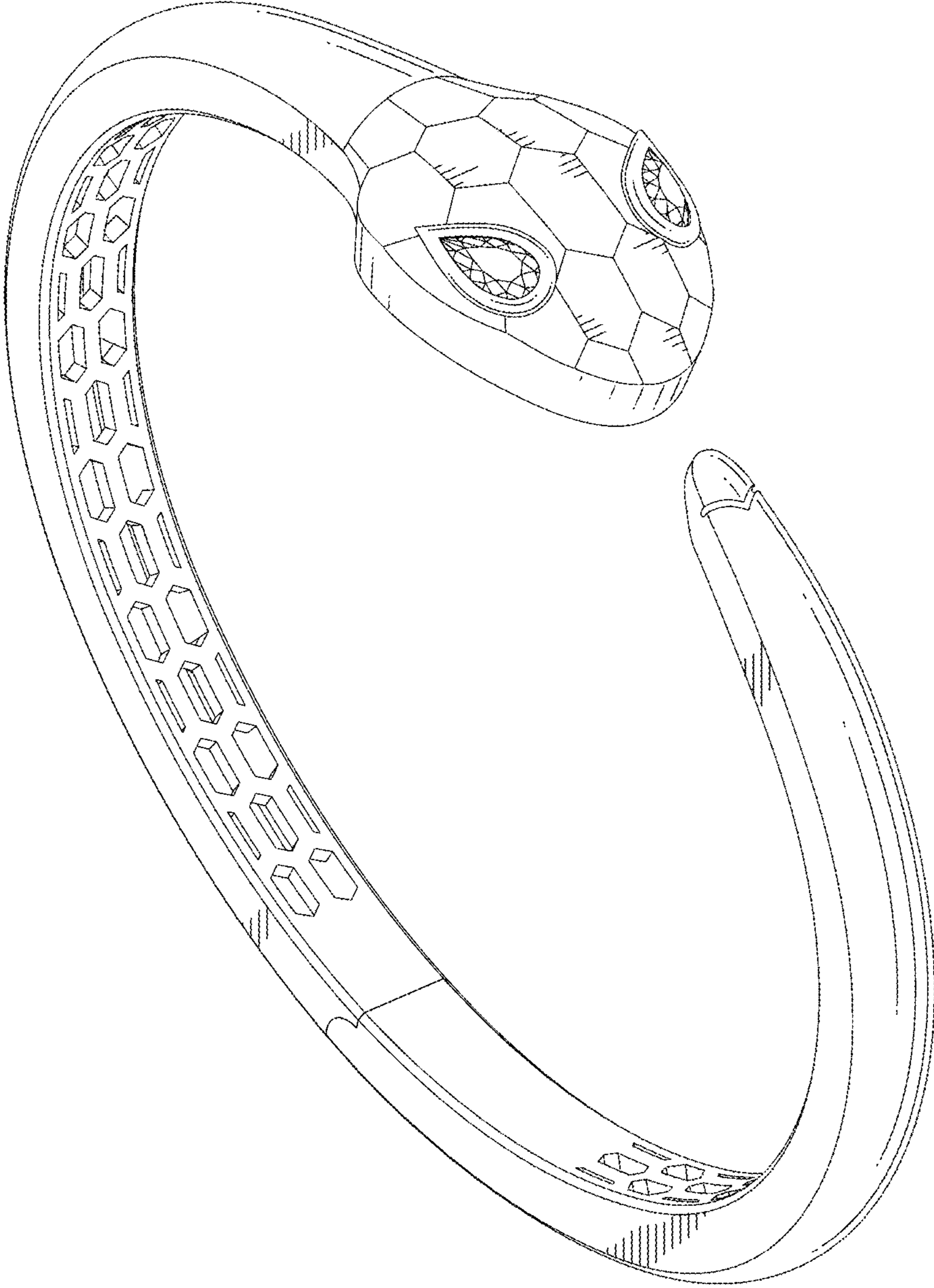

FIG. 1

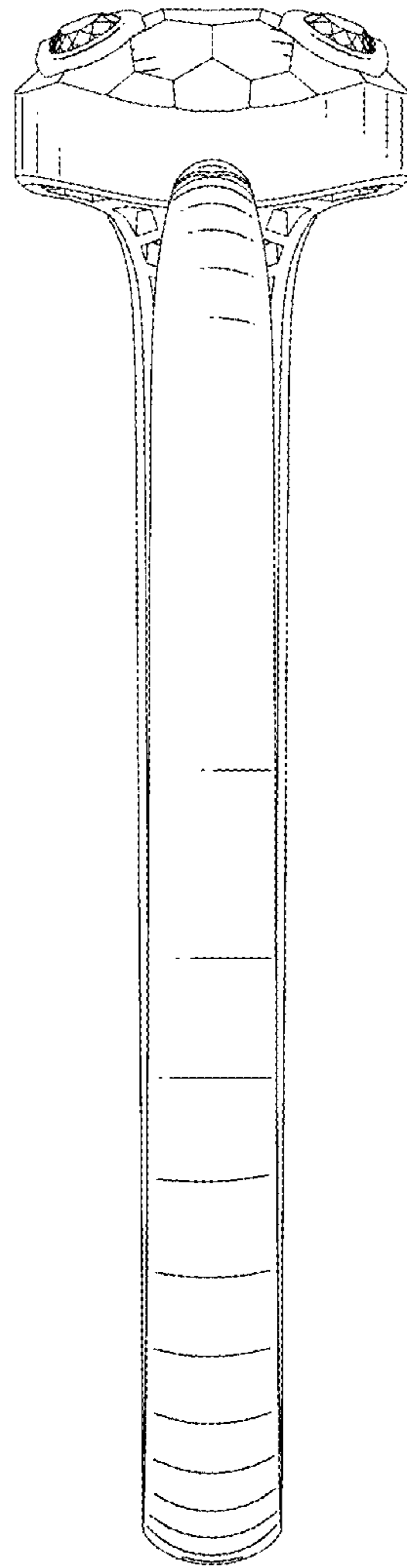

FIG. 2

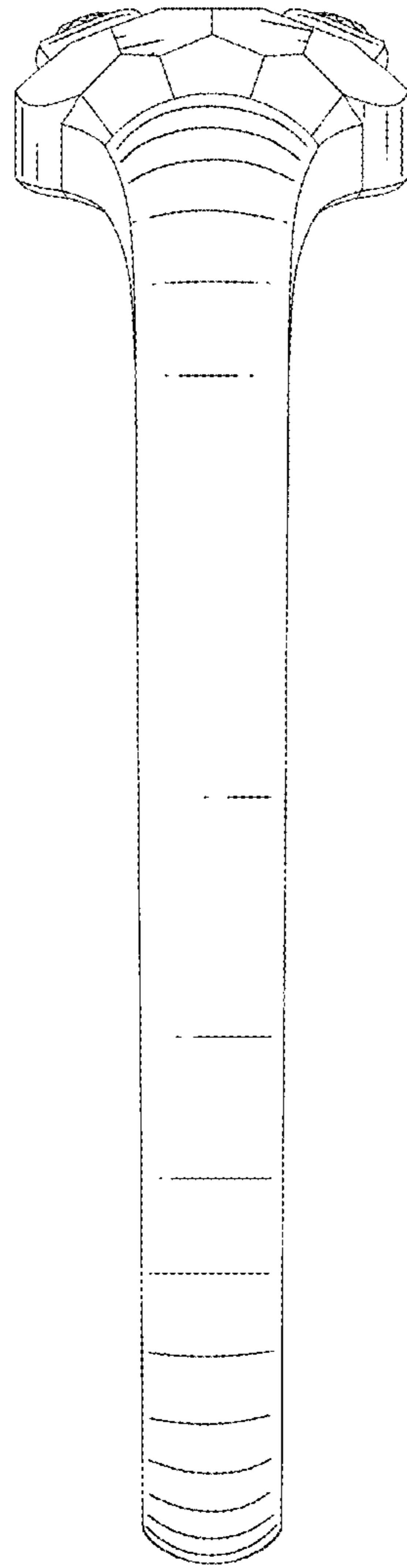

FIG. 3

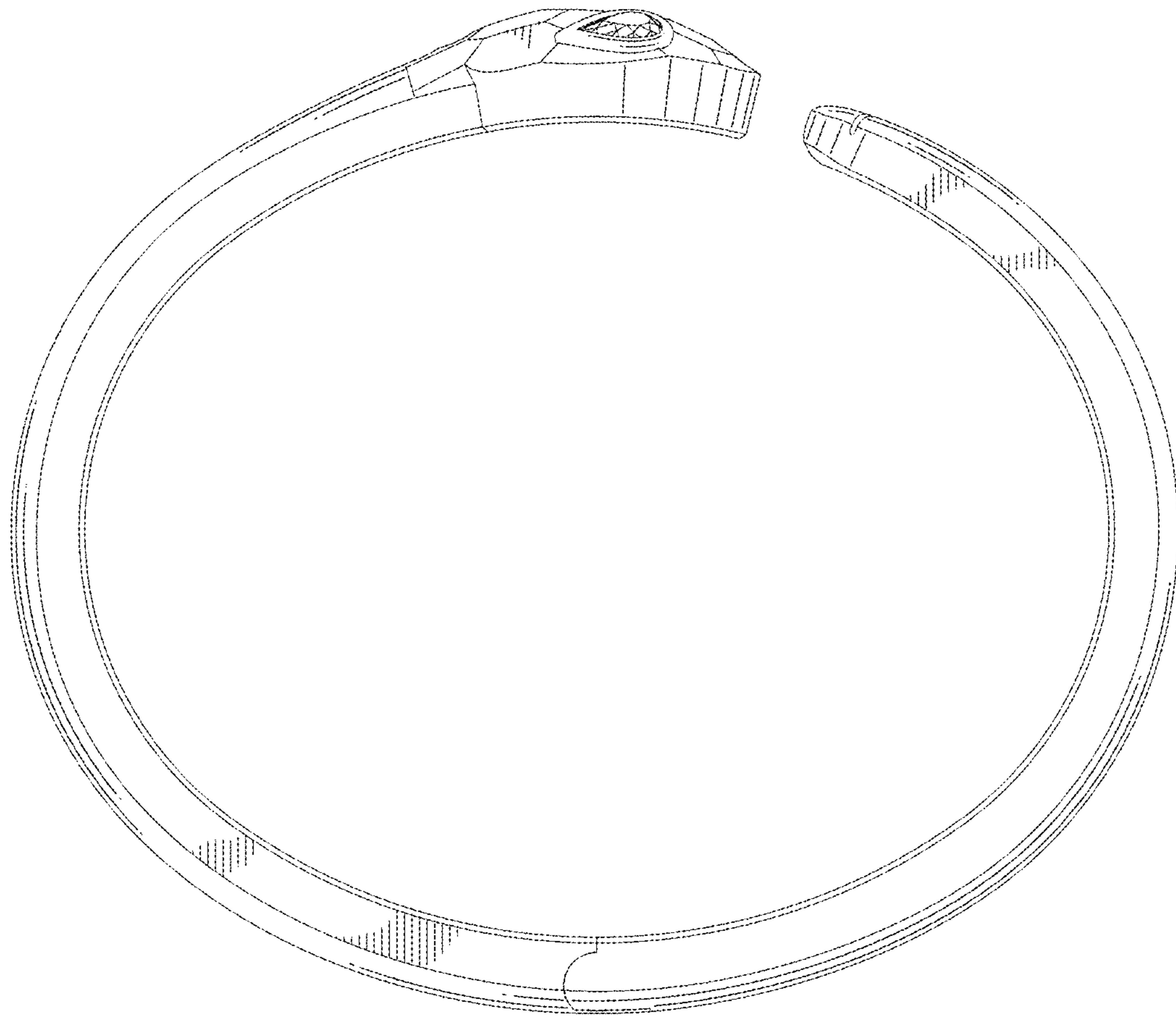

FIG. 4

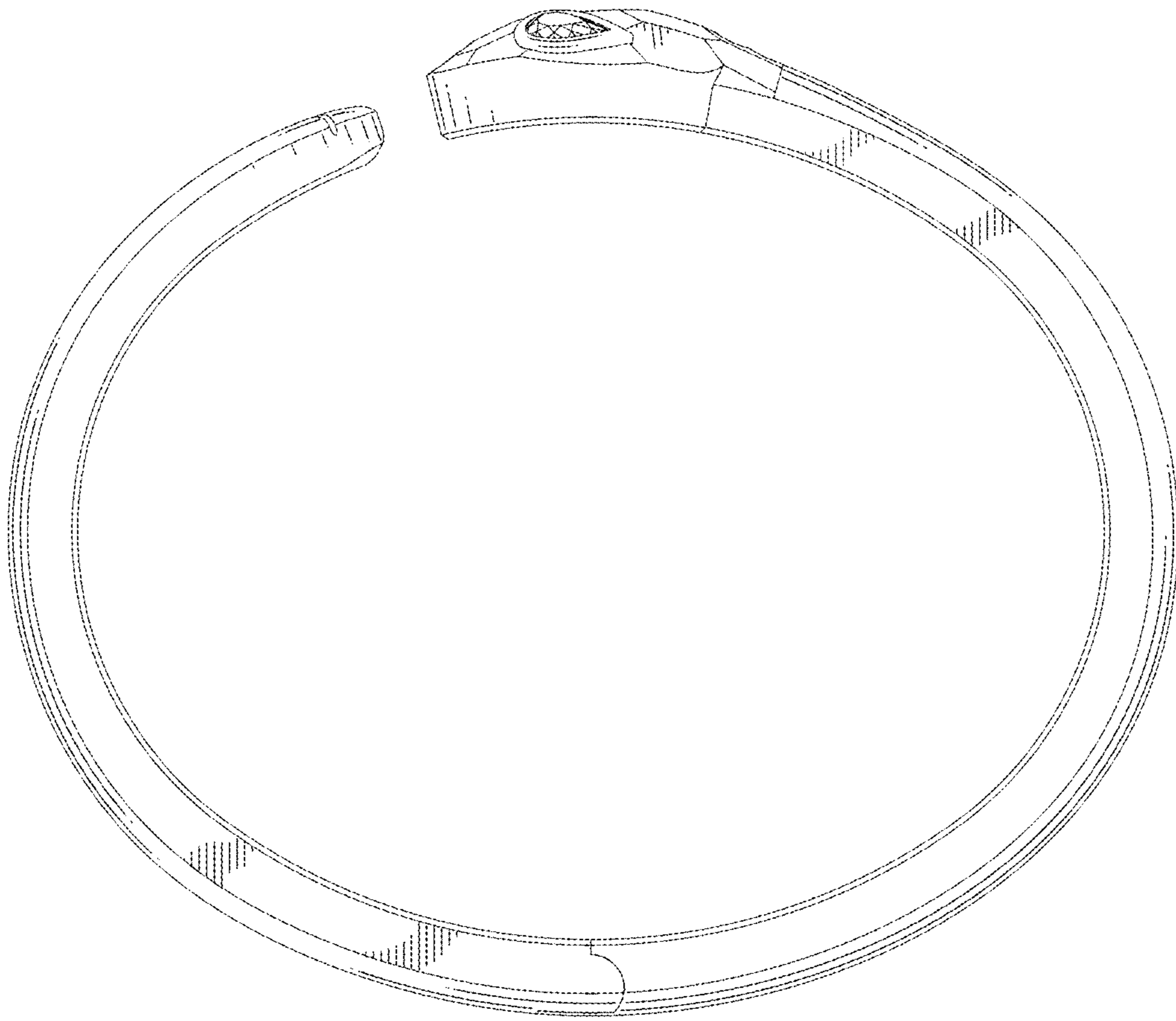

FIG. 5

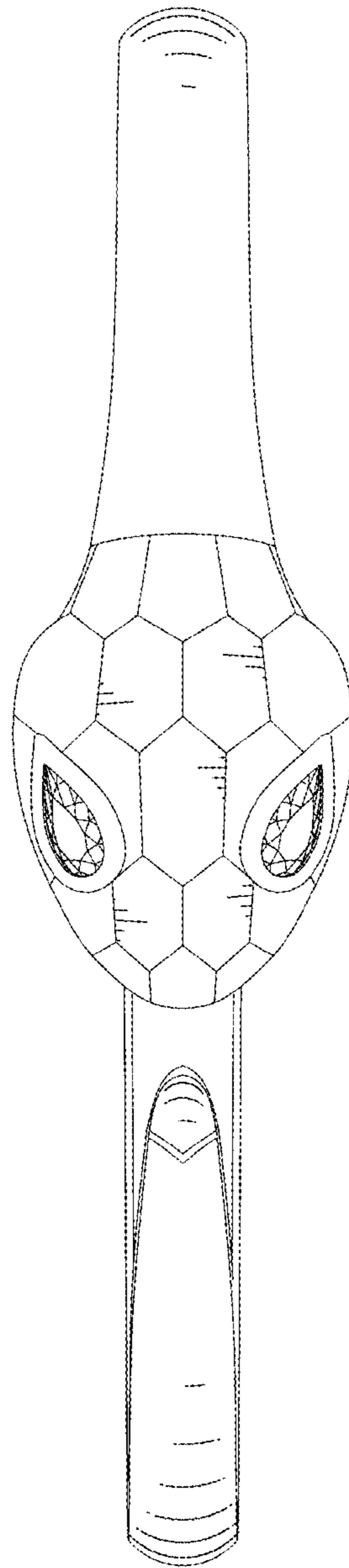

FIG. 6

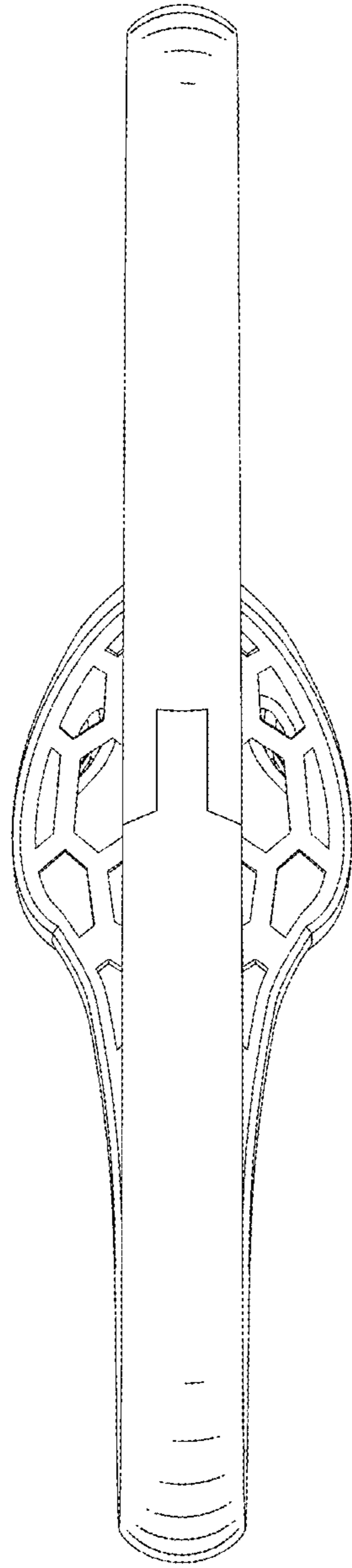

FIG. 7