



US00D814856S

(12) **United States Design Patent**  
**Kristinik**

(10) **Patent No.:** **US D814,856 S**  
(45) **Date of Patent:** **\*\* Apr. 10, 2018**

(54) **DRINKING BOTTLE LID INCLUDING A COOLANT CONTAINER**

(71) Applicant: **KFS Marketing, Inc.**, Schulenburg, TX (US)

(72) Inventor: **Elgin R. Kristinik**, Schulenburg, TX (US)

(73) Assignee: **KFS Marketing, Inc.**, Schulenburg, TX (US)

(\*\*) Term: **15 Years**

(21) Appl. No.: **29/586,517**

(22) Filed: **Dec. 5, 2016**

(51) **LOC (11) Cl.** ..... **07-99**

(52) **U.S. Cl.**

USPC ..... **D7/392.1; D7/396.2; D7/507**

(58) **Field of Classification Search**

USPC .... D7/392.1, 396.2, 396.3, 396.6, 397, 398, D7/399, 400, 402, 387, 213, 388, 510, D7/511, 507, 624.1, 624.2, 506, 505, 406, D7/708.1, 619.1, 622, 633, 635, 532, 523, D7/512; D9/435, 436, 440, 453, 455, D9/499, 454, 415, 434, 520; 220/200, 220/703, 592.16, 592.17; D20/22, 23, 24, D20/26, 27, 28, 29, 43, 32, 19, 10, 4; D11/4

CPC .... B65D 41/04; B65D 41/0414; B65D 43/02; B65D 41/56; Y10S 330/903; A47G 19/2288; A47G 2019/2277; A47G 19/2227; G09F 3/00

See application file for complete search history.

(56) **References Cited**

**U.S. PATENT DOCUMENTS**

D8,007 S 1/1875 Bosworth  
205,486 A \* 7/1878 Johnson ..... B65D 81/18  
220/592.01

852,472 A \* 5/1907 Tracey ..... A47J 36/08  
210/469  
1,631,951 A \* 6/1927 McAnsh ..... B65D 47/061  
222/523  
1,750,334 A \* 3/1930 Stern ..... A47J 43/27  
220/506  
D219,898 S \* 2/1971 Buckley ..... D7/300.1  
D244,504 S \* 5/1977 Merz ..... D10/46.2  
D374,147 S \* 10/1996 Lill Lund ..... D7/300.1  
D410,874 S \* 6/1999 Zastudil ..... D12/606  
6,666,329 B1 \* 12/2003 Charbonneau ..... A45F 3/20  
206/218  
D510,235 S 10/2005 Sorenson  
7,175,294 B1 \* 2/2007 Estrada ..... A47G 19/2227  
362/101  
D706,134 S \* 6/2014 Sory ..... D9/435  
D723,790 S \* 3/2015 Tetsuro ..... D3/11

(Continued)

*Primary Examiner* — Marianne Pandozzi

*Assistant Examiner* — Jae Liang

(74) *Attorney, Agent, or Firm* — Christopher L. Makay

(57) **CLAIM**

The ornamental design for a drinking bottle lid including a coolant container, as shown and described.

**DESCRIPTION**

FIG. 1 is a top perspective view of a drinking bottle lid including a coolant container showing my new design; FIG. 2 is a front view thereof; FIG. 3 is a rear view thereof; FIG. 4 is a left side view thereof; FIG. 5 is a right side view thereof; FIG. 6 is a top view thereof; FIG. 7 is a bottom view thereof; and, FIG. 8 is a bottom perspective view thereof. The broken lines in the drawing depict environmental subject matter only and form no part of the claimed design.

**1 Claim, 7 Drawing Sheets**

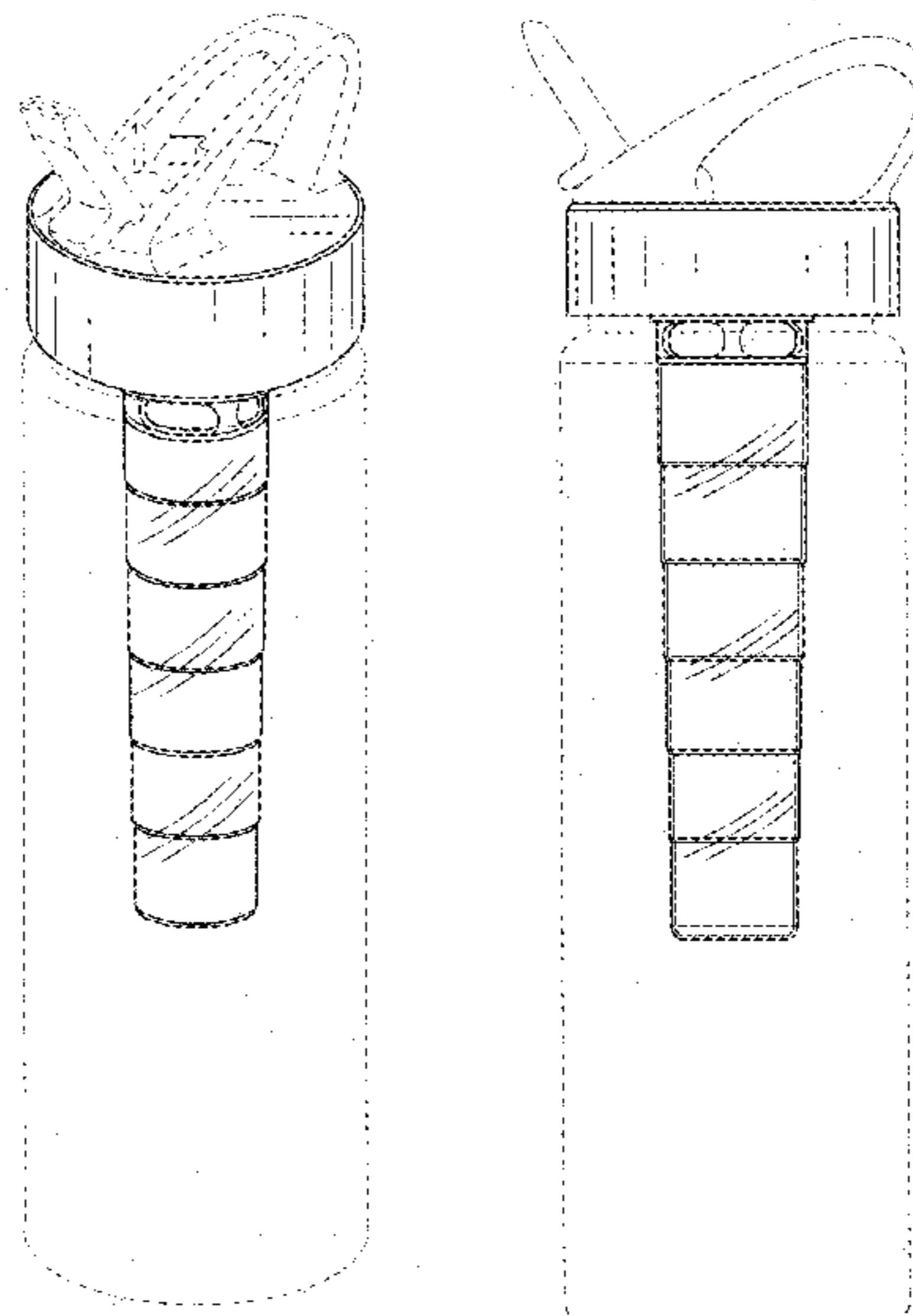

(56)

**References Cited**

U.S. PATENT DOCUMENTS

D729,569 S	5/2015	Herbst et al.	
D729,579 S	5/2015	Molayem	
D748,476 S *	2/2016	Lakstins .....	D9/447
D779,937 S *	2/2017	Lane .....	D9/436
2008/0023103 A1 *	1/2008	Ballinger .....	B67C 11/00 141/338
2016/0045047 A1 *	2/2016	Healy .....	A47G 19/2288 220/592.16
2016/0075477 A1 *	3/2016	Halioua .....	A47J 31/446 222/566
2016/0183590 A1 *	6/2016	Bert .....	A24F 3/00 131/328

\* cited by examiner

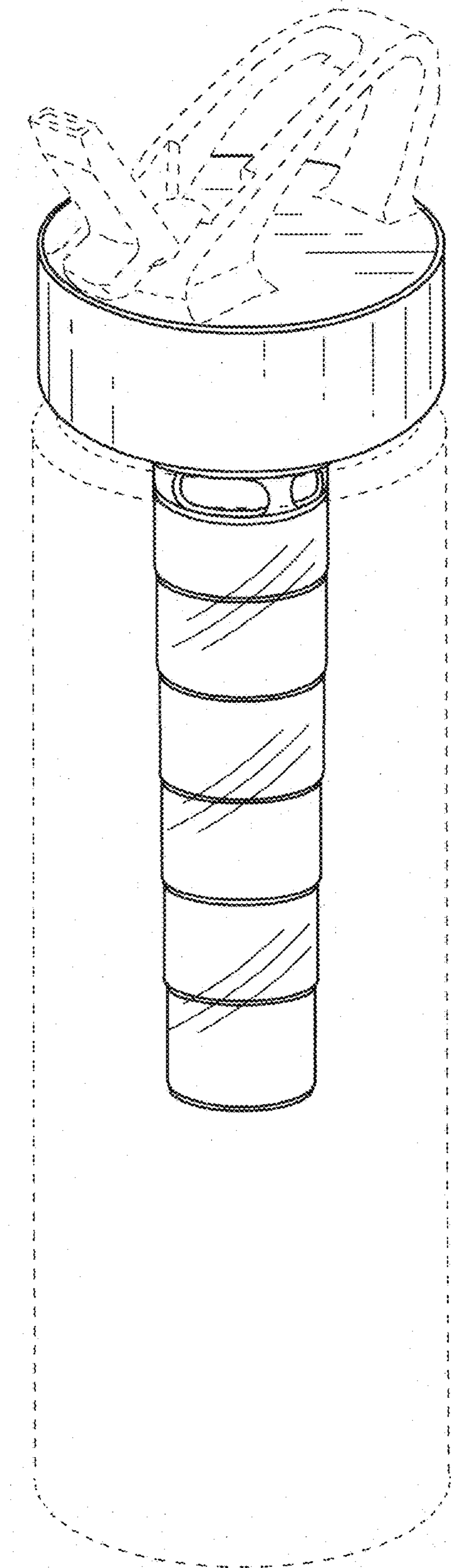

Fig. 1

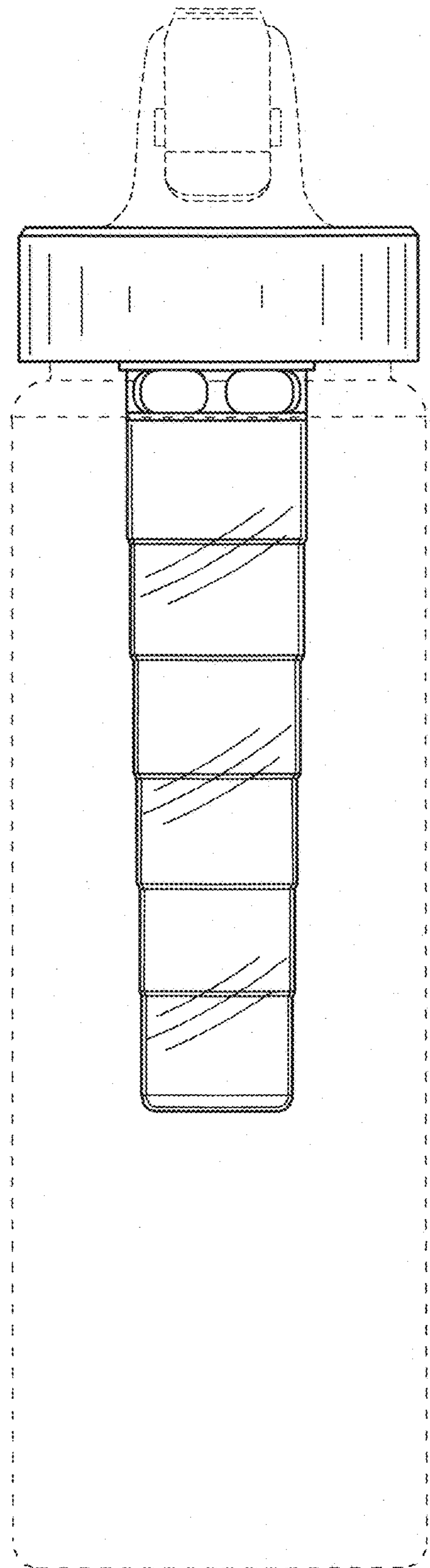

Fig. 2

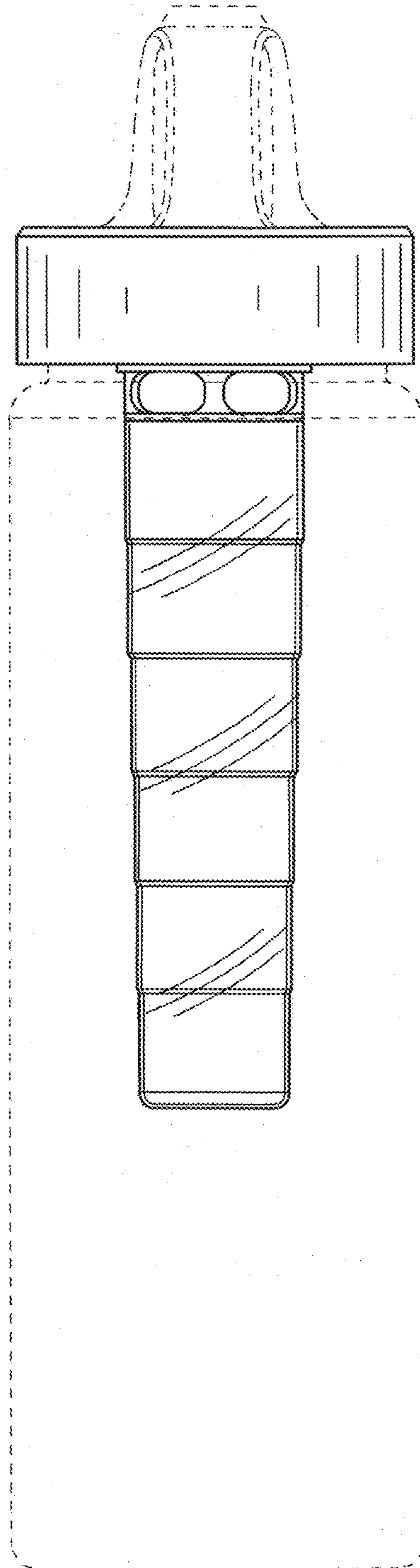

Fig. 3

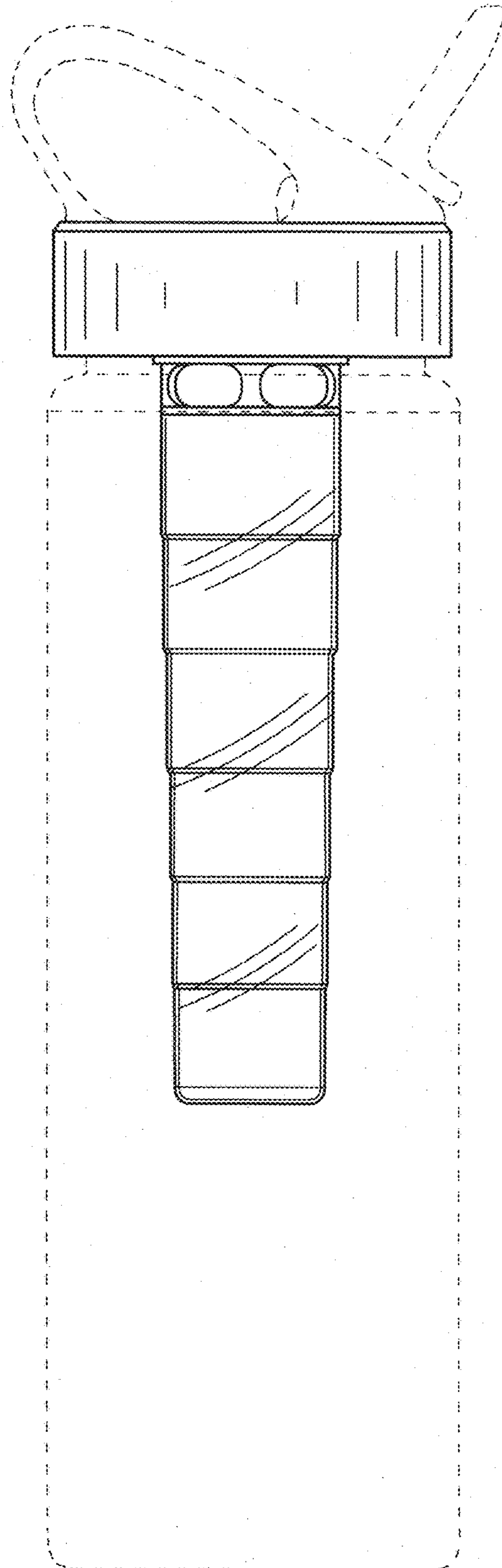

Fig. 4

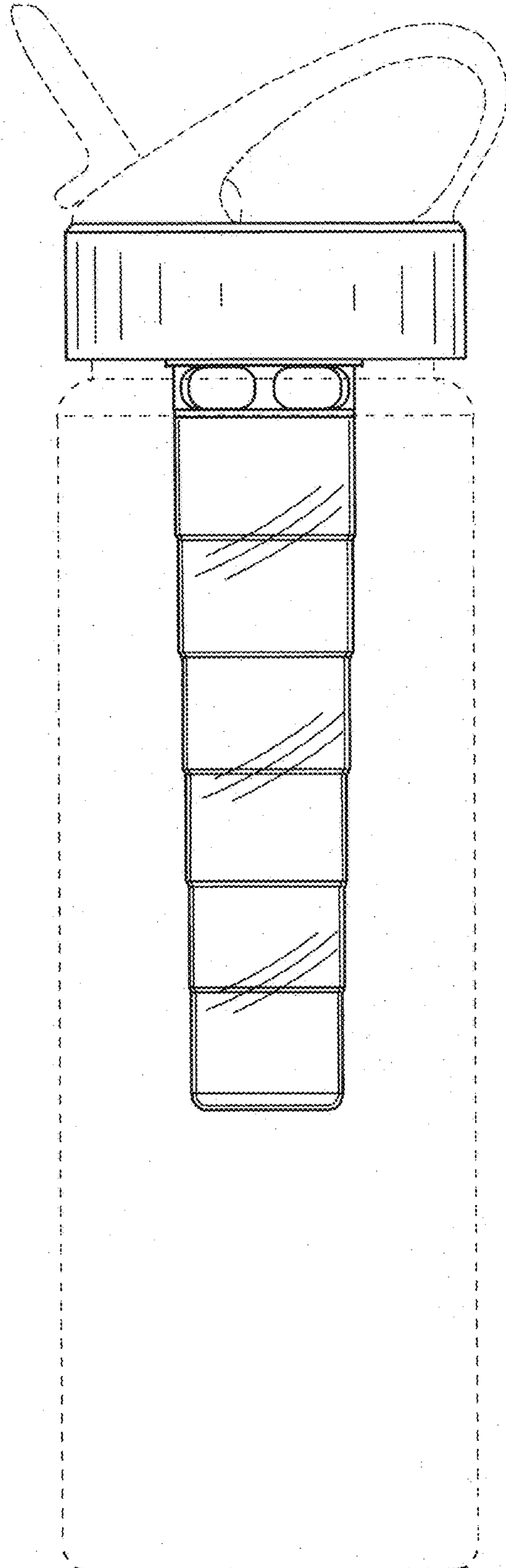
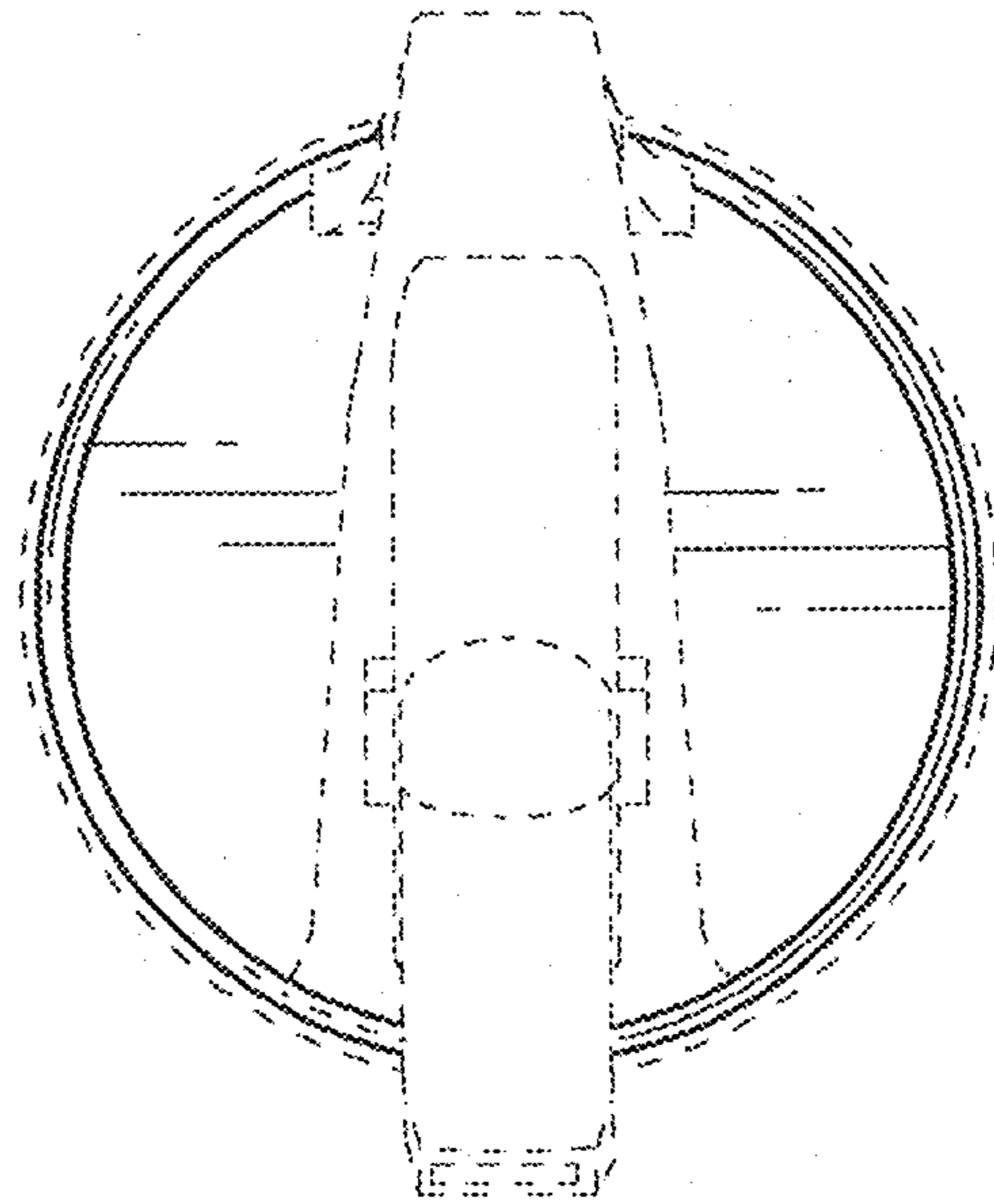
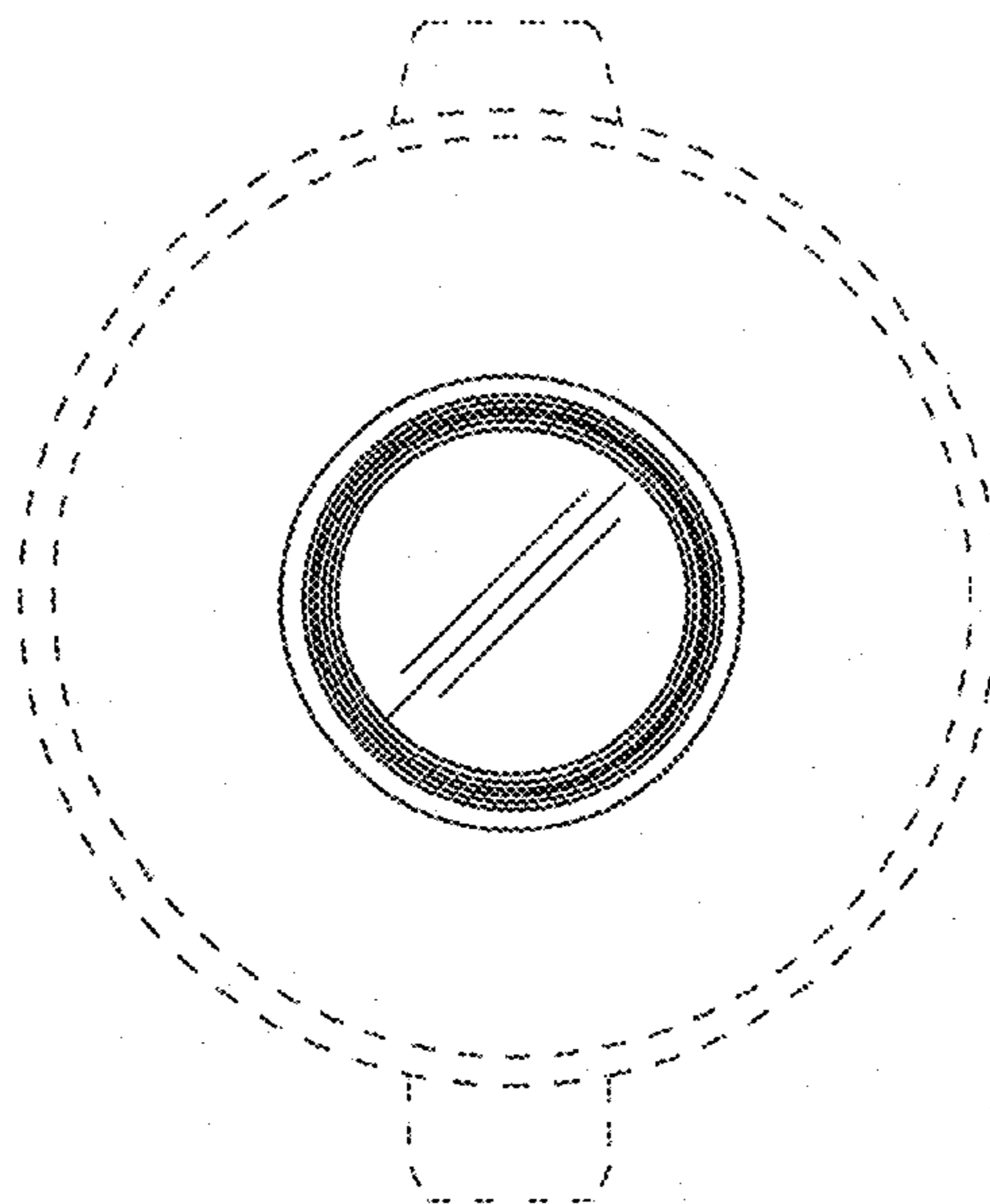

Fig. 5



*Fig. 6*



*Fig. 7*



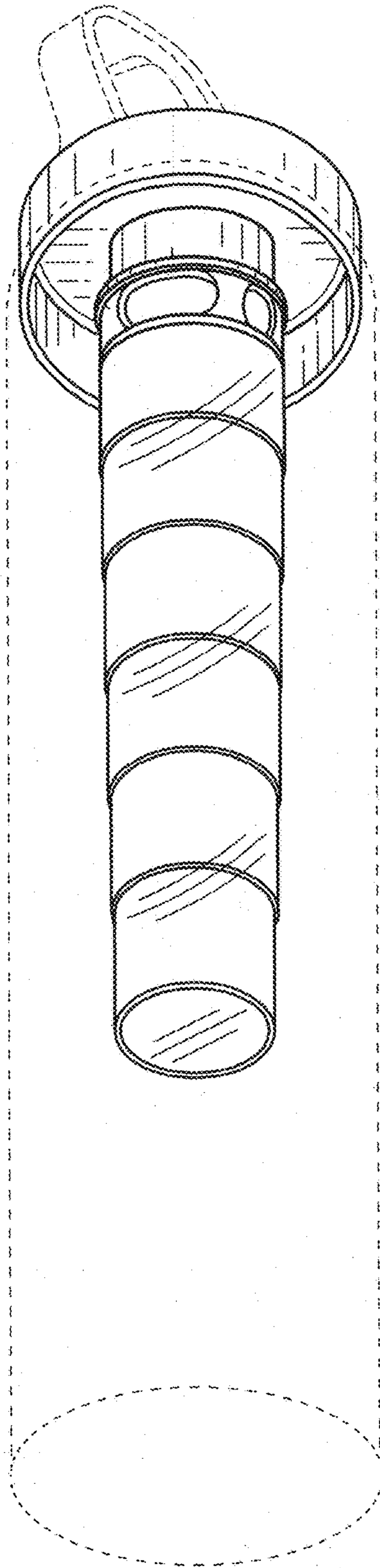

Fig. 8