



US00D814754S

(12) **United States Design Patent** (10) **Patent No.:** **US D814,754 S**  
**Hendrix et al.** (45) **Date of Patent:** **\*\* Apr. 10, 2018**

(54) **SOLE FOR FOOTWEAR**

13/28; A43B 13/30; A43B 13/32; A43B 13/34; A43B 13/36

See application file for complete search history.

(71) Applicant: **Vionic Group LLC**, San Rafael, CA (US)

(56) **References Cited**

(72) Inventors: **Tony Hendrix**, San Francisco, CA (US); **Terry Mitchell**, Larkspur, CA (US); **Constantino Fournier**, San Rafael, CA (US)

U.S. PATENT DOCUMENTS

D187,781 S \* 5/1960 Hayakawa ..... 36/11.5  
3,290,802 A \* 12/1966 Fukuoka ..... A43B 3/105  
36/11.5  
D338,320 S \* 8/1993 Haggar ..... D2/917

(Continued)

(73) Assignee: **Vionic Group LLC**, San Rafael, CA (US)

OTHER PUBLICATIONS

Beach Noosa Toe Post Sandal, VionicShoes.com, [online], [site visited Apr. 17, 2017]. <URL: <http://www.vionicshoes.com/women/sandals/beach-noosa-toepost-sandal.html>>.\*

(Continued)

(\*\*) Term: **15 Years**

*Primary Examiner* — T. Chase Nelson

*Assistant Examiner* — Jonathan J. Han

(21) Appl. No.: **29/570,907**

(22) Filed: **Jul. 13, 2016**

(74) *Attorney, Agent, or Firm* — Reed Smith LLP; Nina Habib Borders

(51) **LOC (11) Cl.** ..... **02-04**

(52) **U.S. Cl.**  
USPC ..... **D2/956**; D2/951; D2/954

(57) **CLAIM**

The ornamental design for the sole for footwear, as shown and described.

(58) **Field of Classification Search**

**DESCRIPTION**

USPC ..... D2/902, 906, 908, 916, 918, 925, D2/946–962, 977; 36/1, 1.5, 3 B, 22 R, 36/24.5, 25 R, 28, 32 R, 34 R, 59 C, 36/67 A, 101–107, 114–116, 117.3, 117.4, 36/124–136

CPC ..... A43B 13/00; A43B 13/02; A43B 13/023; A43B 13/026; A43B 13/04; A43B 13/08; A43B 13/10; A43B 13/12; A43B 13/14; A43B 13/141; A43B 13/143; A43B 13/16; A43B 13/18; A43B 13/181; A43B 13/187; A43B 13/189; A43B 13/20; A43B 13/22; A43B 13/223; A43B 13/24; A43B

FIG. 1 is a top perspective view of my ornamental design for a sole for footwear;  
FIG. 2 is a right side elevation view thereof;  
FIG. 3 is a left side elevation view thereof;  
FIG. 4 is a top plan view thereof;  
FIG. 5 is a bottom plan view thereof;  
FIG. 6 is a rear elevational view thereof; and  
FIG. 7 is a front elevational view thereof.  
FIG. 8 is a cross-sectional view along the line 8-8 in FIG. 4.  
FIG. 9 is a cross-sectional view along the line 9-9 in FIG. 4; and,  
FIG. 10 is a cross-sectional view along the line 10-10 in FIG. 4.

(Continued)

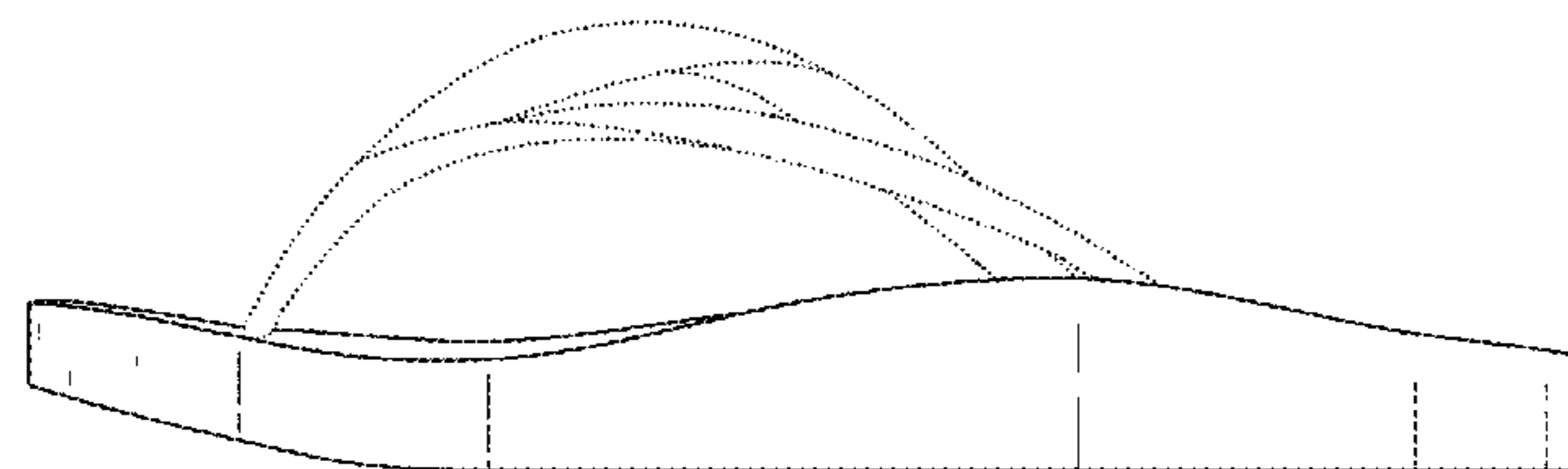
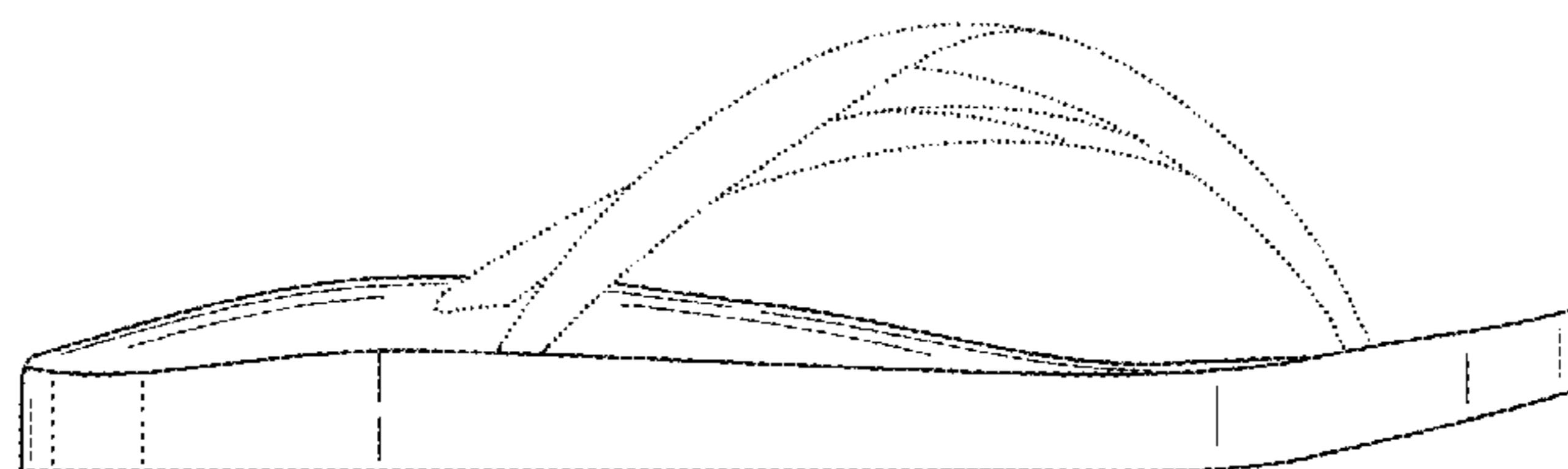

The drawings illustrate a first embodiment of a sole for footwear for use on a person's right foot. A second embodiment is a sole for footwear for use on a person's left foot, and while not shown, is a mirror image of the right sole shown here.

**1 Claim, 3 Drawing Sheets**

(56)

**References Cited**

U.S. PATENT DOCUMENTS

D409,359	S *	5/1999	Condi	.....	D2/916
D456,123	S *	4/2002	Powell	.....	D2/917
D500,397	S *	1/2005	Dal Magro	.....	D2/917
D568,032	S *	5/2008	Lavergne	.....	D2/917
D592,841	S *	5/2009	Escario	.....	D2/917
D613,044	S *	4/2010	Fu	.....	D2/917
D617,982	S *	6/2010	Escario	.....	D2/917
D619,340	S *	7/2010	Feller	.....	D2/916
D622,945	S *	9/2010	Vasyli	.....	D2/951
D648,511	S *	11/2011	Trickey	.....	D2/917
D661,065	S *	6/2012	Marcos Da Silva	.....	D2/917
D661,473	S *	6/2012	Panariello, Jr.	.....	D2/917
D663,512	S *	7/2012	Van Zyll De Jong	.....	D2/917
D668,855	S *	10/2012	Victor	.....	D2/948
D673,353	S *	1/2013	Elze	.....	D2/917
D711,077	S *	8/2014	Bell	.....	D2/917
D744,209	S *	12/2015	Kinchington	.....	D2/917
D758,057	S *	6/2016	Zlatanovski	.....	D2/947
9,380,836	B1 *	7/2016	Vigil	.....	A43B 3/103
D768,363	S *	10/2016	Duarte Angelico	.....	D2/917
D774,202	S *	12/2016	Bielitz	.....	D24/192
D780,417	S *	3/2017	Chang	.....	D2/951
2004/0194342	A1 *	10/2004	Steinberg	.....	A43B 3/108 36/11.5
2005/0217141	A1 *	10/2005	Cobian	.....	A43B 5/08 36/3 B
2007/0245597	A1 *	10/2007	Krutilek	.....	A43B 3/103 36/101
2009/0313854	A1 *	12/2009	Clarke	.....	A43B 3/105 36/97

2011/0146109	A1 *	6/2011	Martinez	.....	A43B 3/001 36/137
2011/0314694	A1 *	12/2011	Marmar	.....	A43B 3/105 36/11.5
2012/0311889	A1 *	12/2012	George	.....	A43B 3/103 36/101
2015/0007459	A1 *	1/2015	DiMatteo	.....	A43B 3/128 36/102
2015/0223551	A1 *	8/2015	Munro	.....	A43B 3/108 36/11.5
2015/0282553	A1 *	10/2015	Tussy	.....	A43B 3/103 36/97

OTHER PUBLICATIONS

Beach Manly Toe Post Sandal, VionicShoes.com, [online], [site visited Apr. 17, 2017]. <URL: <http://www.vionicshoes.com/men/new-arrivals/beach-manly-toe-post.html>>.\*

Vionic Women's Beach Noosa Flip Flop, Amazon.com, Date first available at Amazon.com: Jan. 7, 2017, [online], [site visited Apr. 17, 2017]. <URL: <https://www.amazon.com/Vionic-Womens-Beach-Noosa-Flip/dp/B01M1ODTSV>>.\*

Vionic Beach Noosa—Women's Arch Supportive Flip Flops, Youtube.com, Orthotic Shop, Published on Nov. 9, 2016, [online], [site visited Apr. 17, 2017]. <URL: <https://www.youtube.com/watch?v=hED13fbqy94>>.\*

Classic Flip-Flops for Women, OldNavy.Gap.com, [online], [site visited Apr. 17, 2017]. <URL: <http://oldnavy.gap.com/browse/product.do?pid=898919892>>.\*

Reef Men's Fanning Sandal, Amazon.com, Date first available at Amazon.com: Oct. 1, 2001, [online], [site visited Apr. 17, 2017]. <URL: <https://www.amazon.com/Reef-Fanning-Mens-Sandal/dp/B001PTHDRS>>.\*

Die-Cut Bottom Rubber Flip Flops, Made-In-China.com, [online], [site visited Apr. 17, 2017]. <URL: <http://dgsjhx.en.made-in-china.com/product/QKSmvFOAbtkJ/China-Die-Cut-Bottom-Rubber-Flip-Flops.html>>.\*

Amor Black Yoga Mat Flip Flops for Women—Leave An Impression, ShareTheLoveToday.com, [online], [site visited Apr. 17, 2017]. <URL: <https://sharethelovetoday.com/products/black-yoga-mat-heart-impression-flip-flops>>.\*

\* cited by examiner

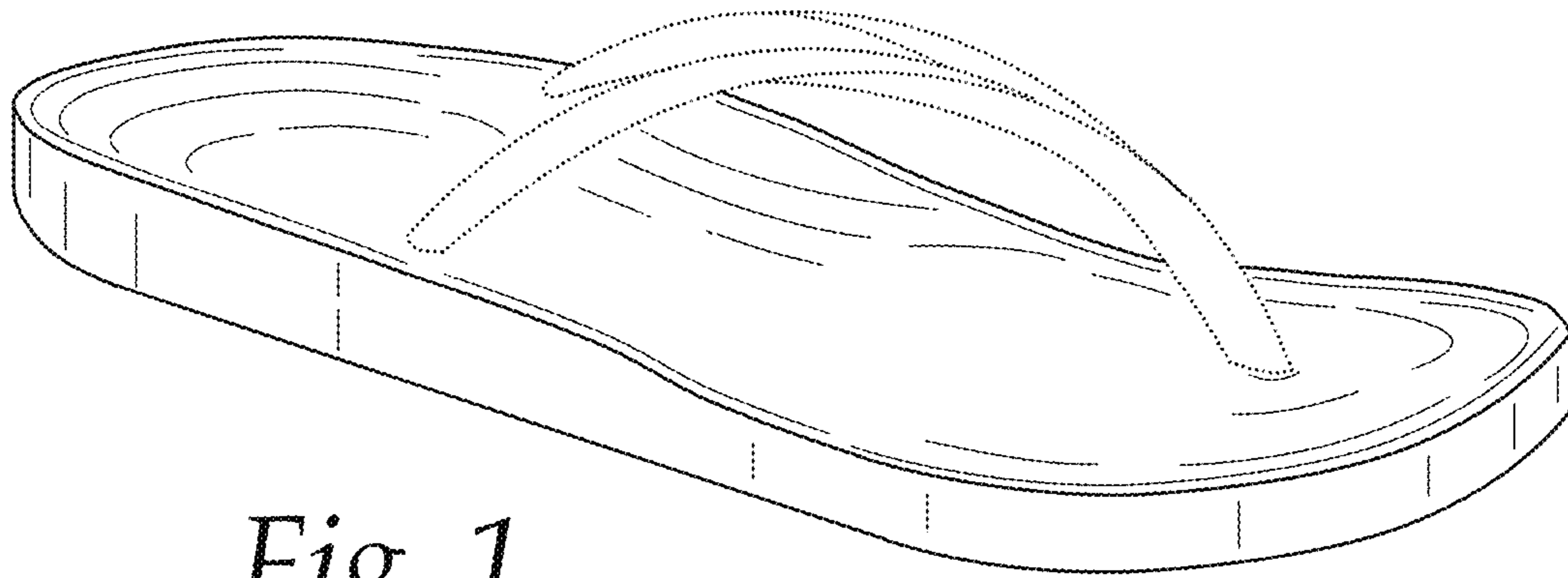

*Fig. 1*

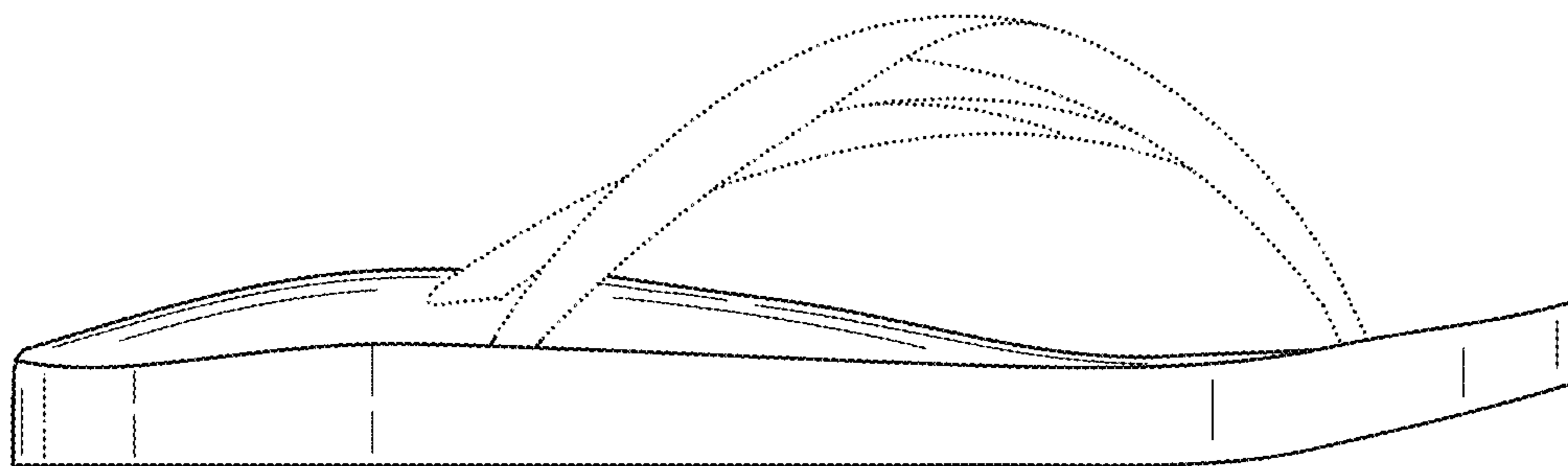

*Fig. 2*

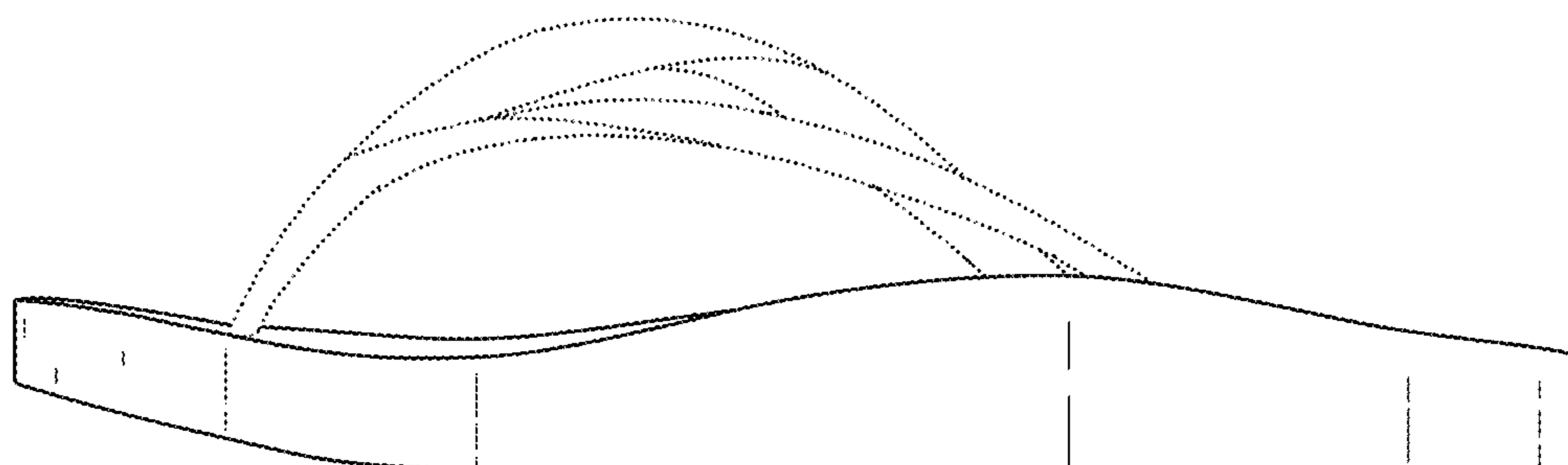

*Fig. 3*

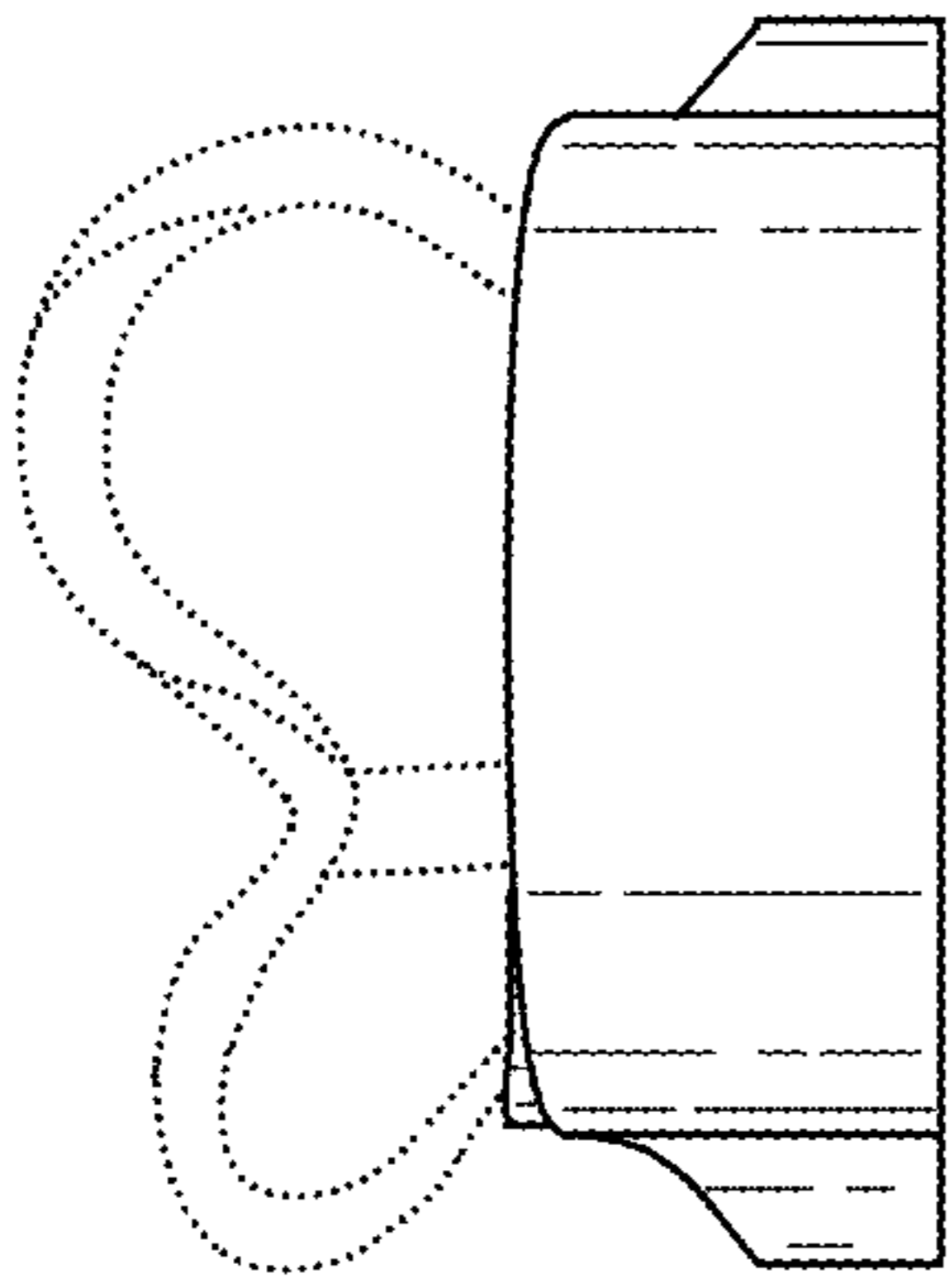

Fig. 6

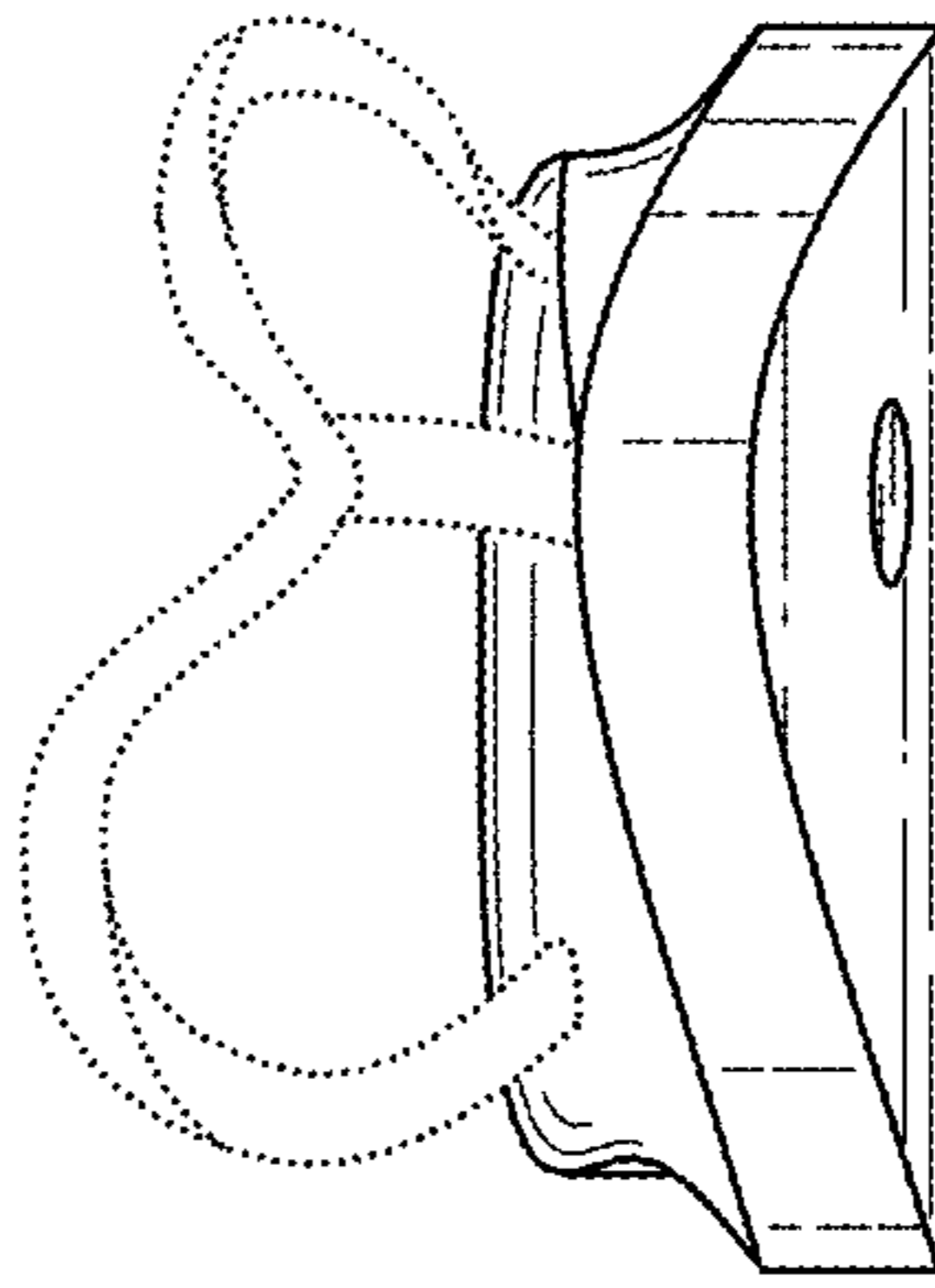

Fig. 7

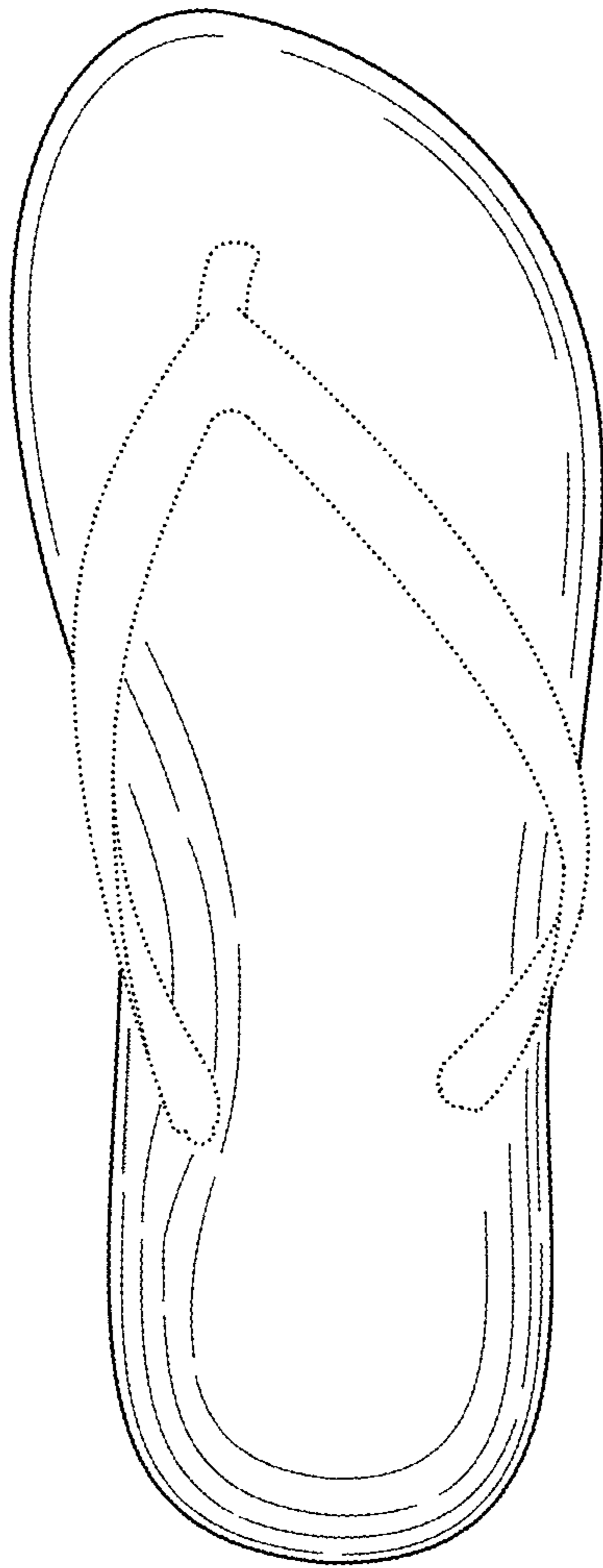

Fig. 4

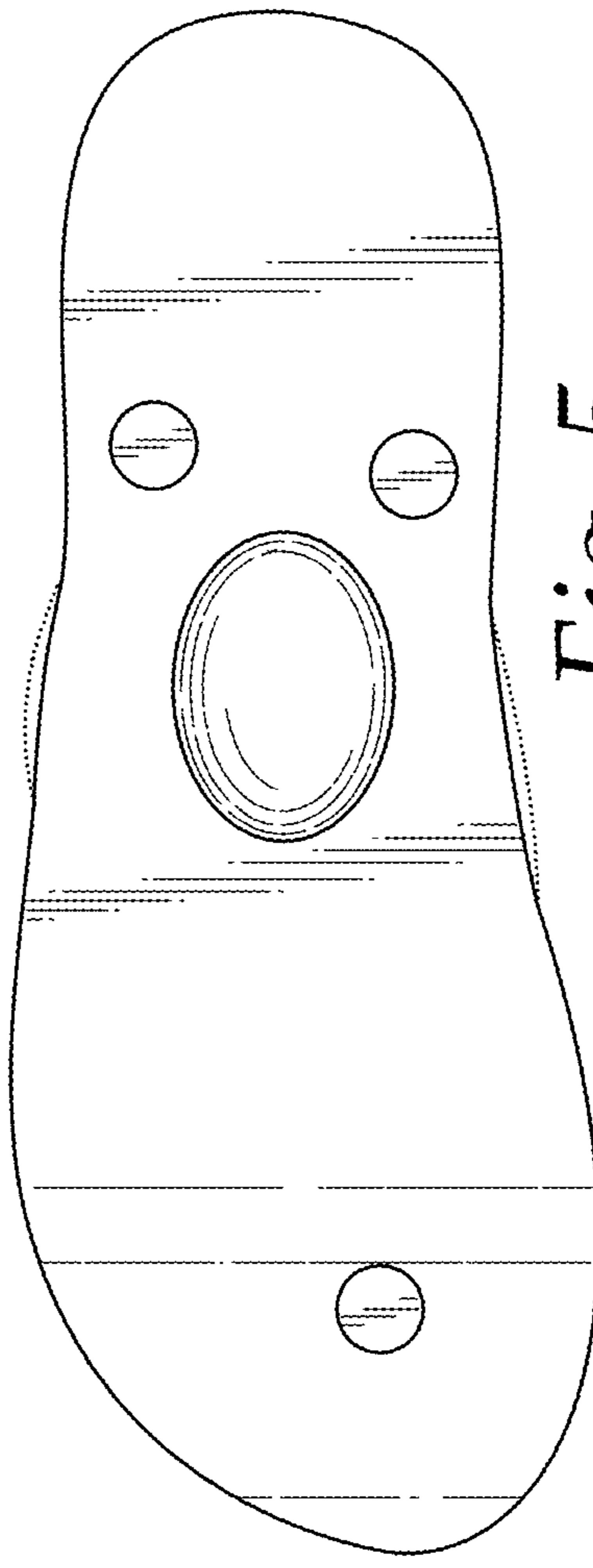
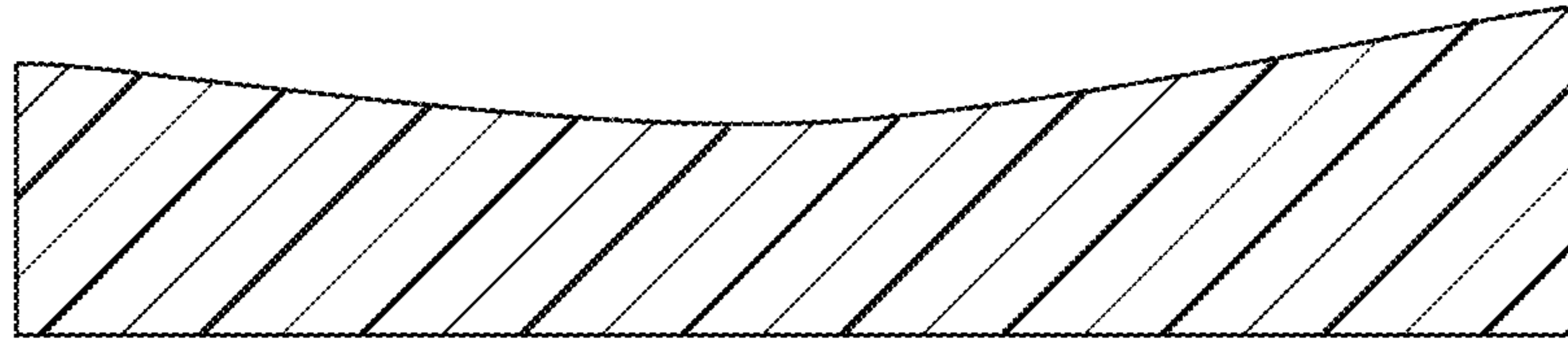
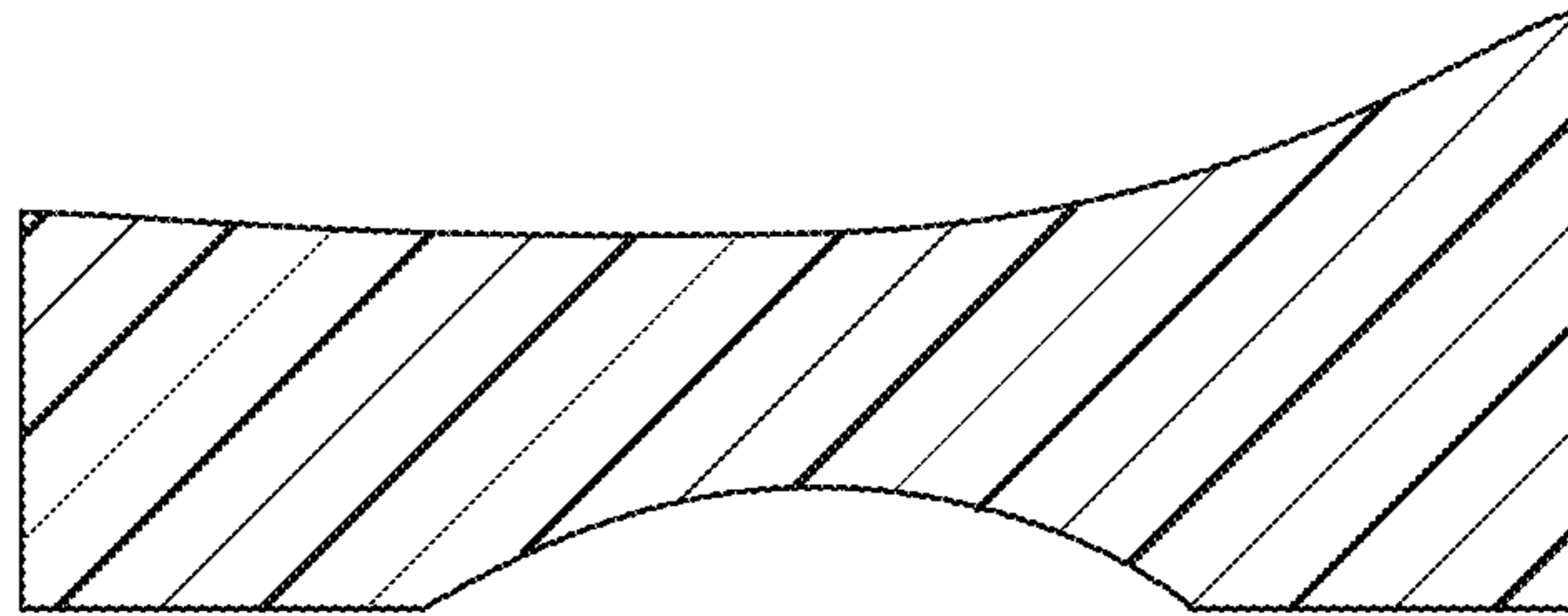

Fig. 5



*Fig. 8*



*Fig. 9*

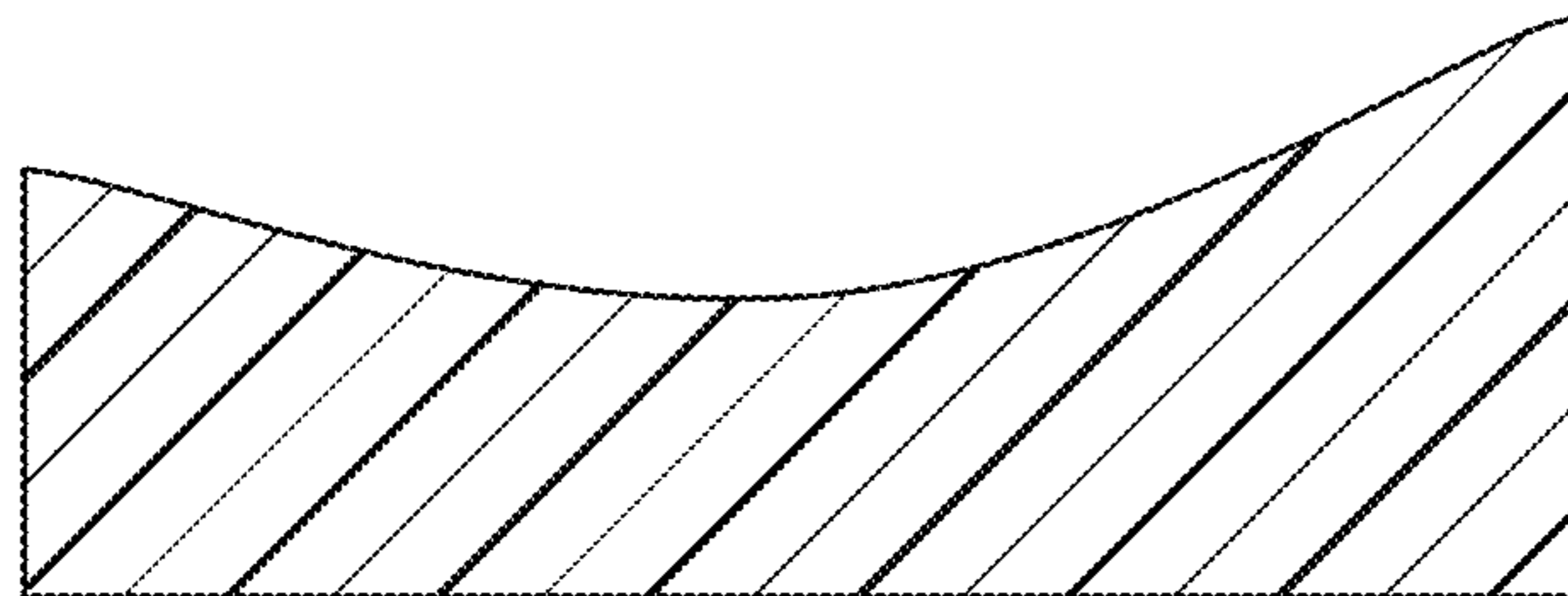

*Fig. 10*