



US00D814666S

(12) **United States Design Patent**
Wang

(10) **Patent No.:** **US D814,666 S**
(45) **Date of Patent:** **** Apr. 3, 2018**

(54) **LIGHTING APPARATUS**

D796,076 S * 8/2017 Barnetson D26/2
D796,701 S * 9/2017 Moon D26/1
D802,176 S * 11/2017 Tan D26/1

(71) Applicant: **Peiwen Wang**, City of Industry, CA
(US)

* cited by examiner

(72) Inventor: **Peiwen Wang**, City of Industry, CA
(US)

Primary Examiner — Brian N. Vinson
(74) *Attorney, Agent, or Firm* — Che-Yang Chen; Law
Offices of Scott Warmuth

(**) Term: **15 Years**

(21) Appl. No.: **29/576,734**

(57) **CLAIM**

(22) Filed: **Sep. 7, 2016**

The ornamental design for a lighting apparatus, as shown
and described.

(51) **LOC (11) Cl.** **26-01**

(52) **U.S. Cl.**
USPC **D26/1**

DESCRIPTION

(58) **Field of Classification Search**
USPC D26/1, 2, 3
CPC H01J 5/48; H01J 5/50; F21V 17/06; F21V
19/001; F21V 19/0025; F21V 19/0015;
F21V 19/004; F21V 19/0045; F21K 9/13
See application file for complete search history.

FIG. 1 is a perspective view of a lighting apparatus showing
my new design;
FIG. 2 is a front elevational view thereof;
FIG. 3 is a rear elevational view thereof;
FIG. 4 is a left side elevational view thereof;
FIG. 5 is a right side elevational view thereof;
FIG. 6 is a top plan view thereof; and,
FIG. 7 is a bottom plan view thereof.
The broken line disclosure in the views represents portions
of the apparatus which forms no part of the claimed design.

(56) **References Cited**

U.S. PATENT DOCUMENTS

D708,360 S * 7/2014 Shibata D26/1
D747,013 S * 1/2016 Qin D26/2

1 Claim, 4 Drawing Sheets

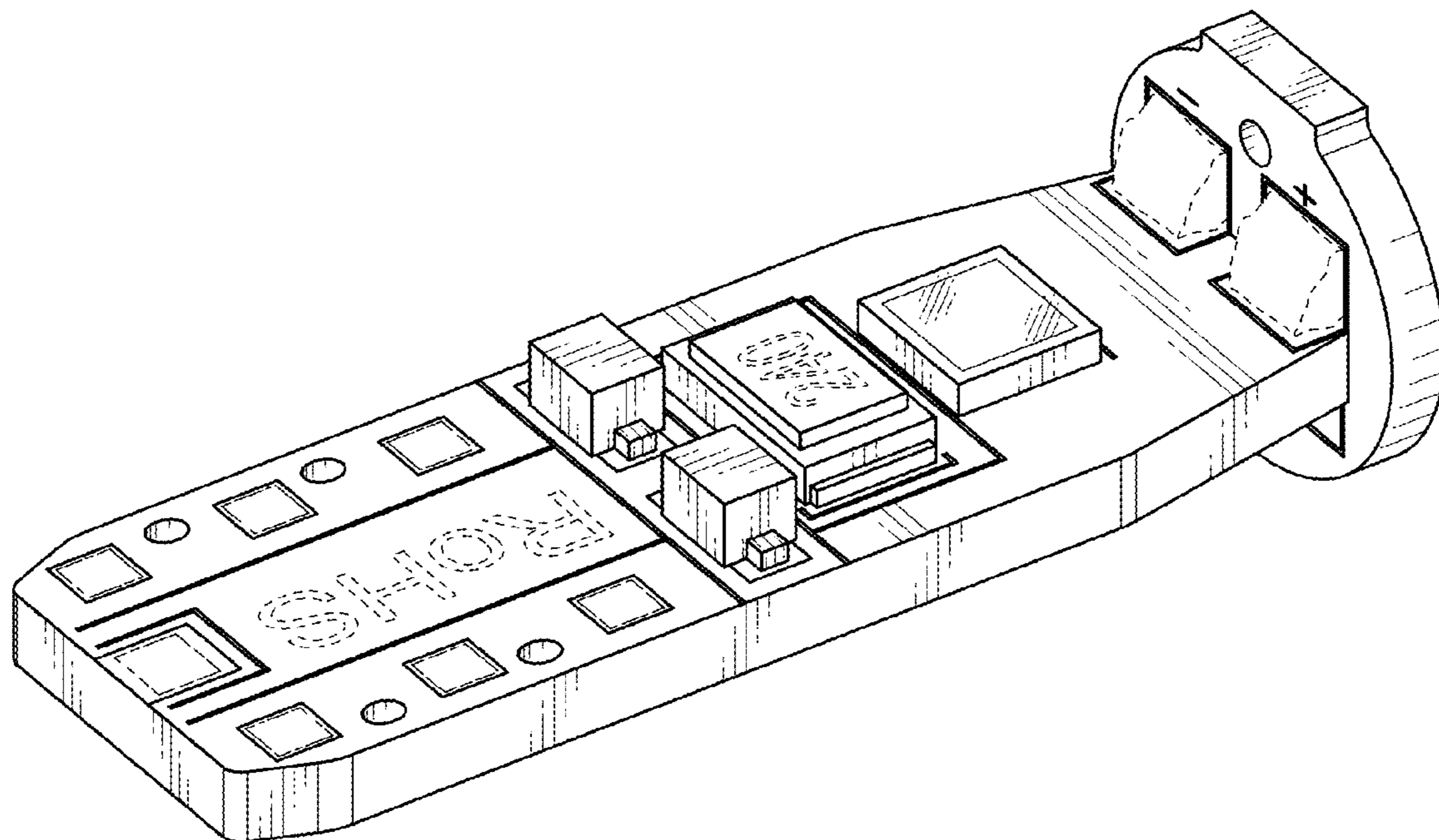

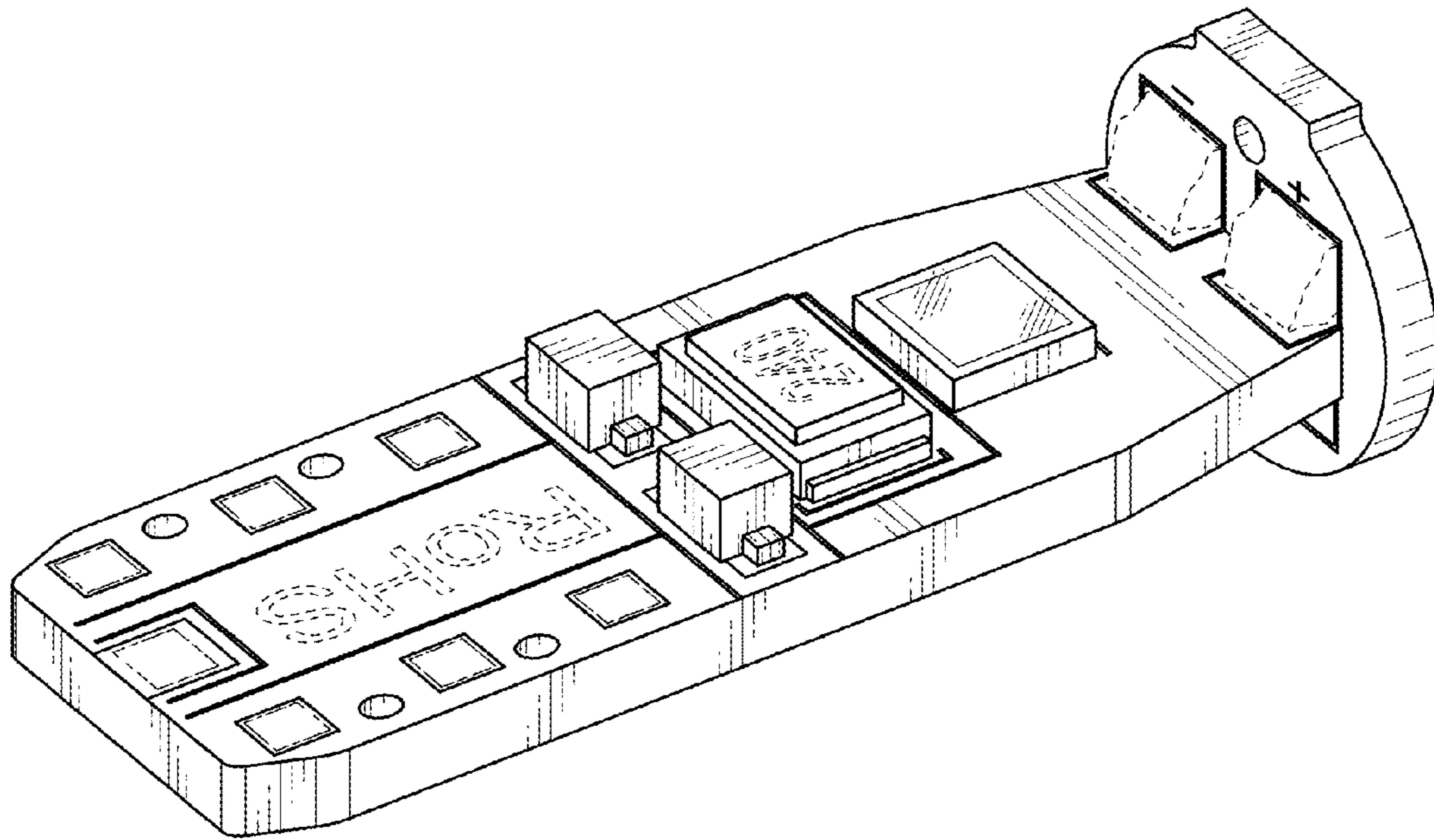

FIG. 1

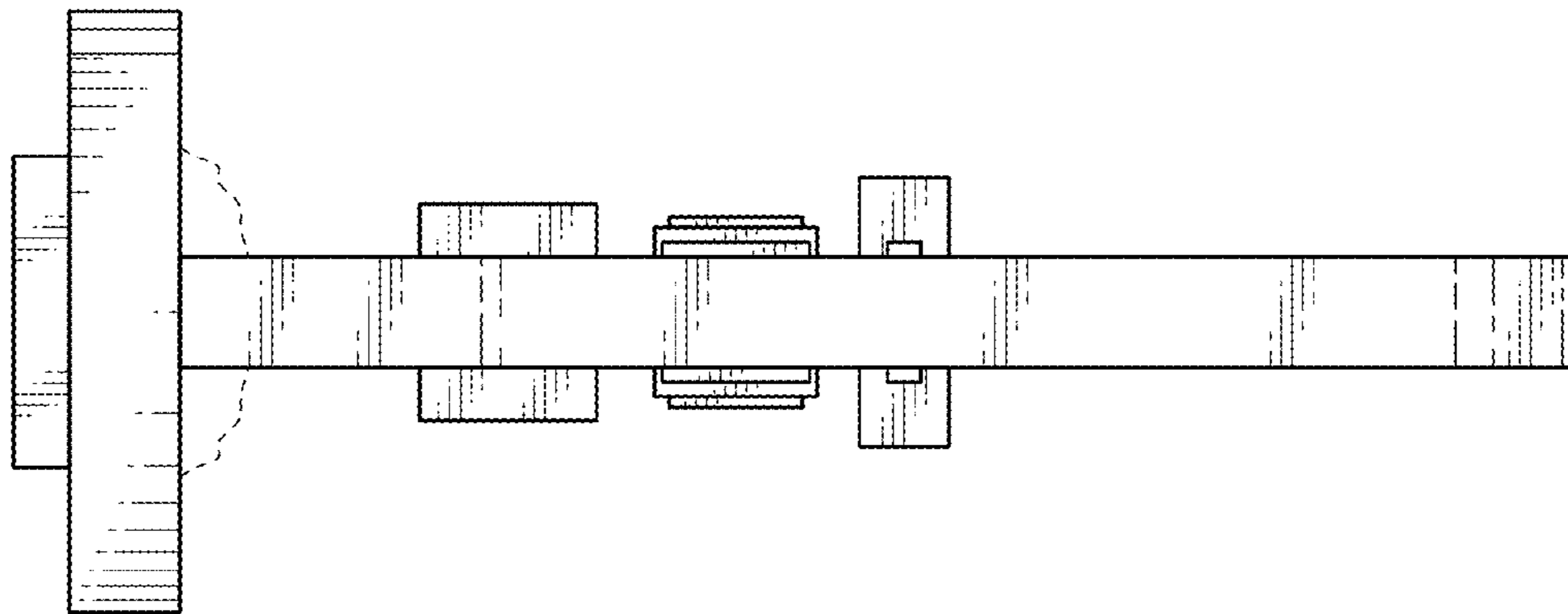

FIG. 2

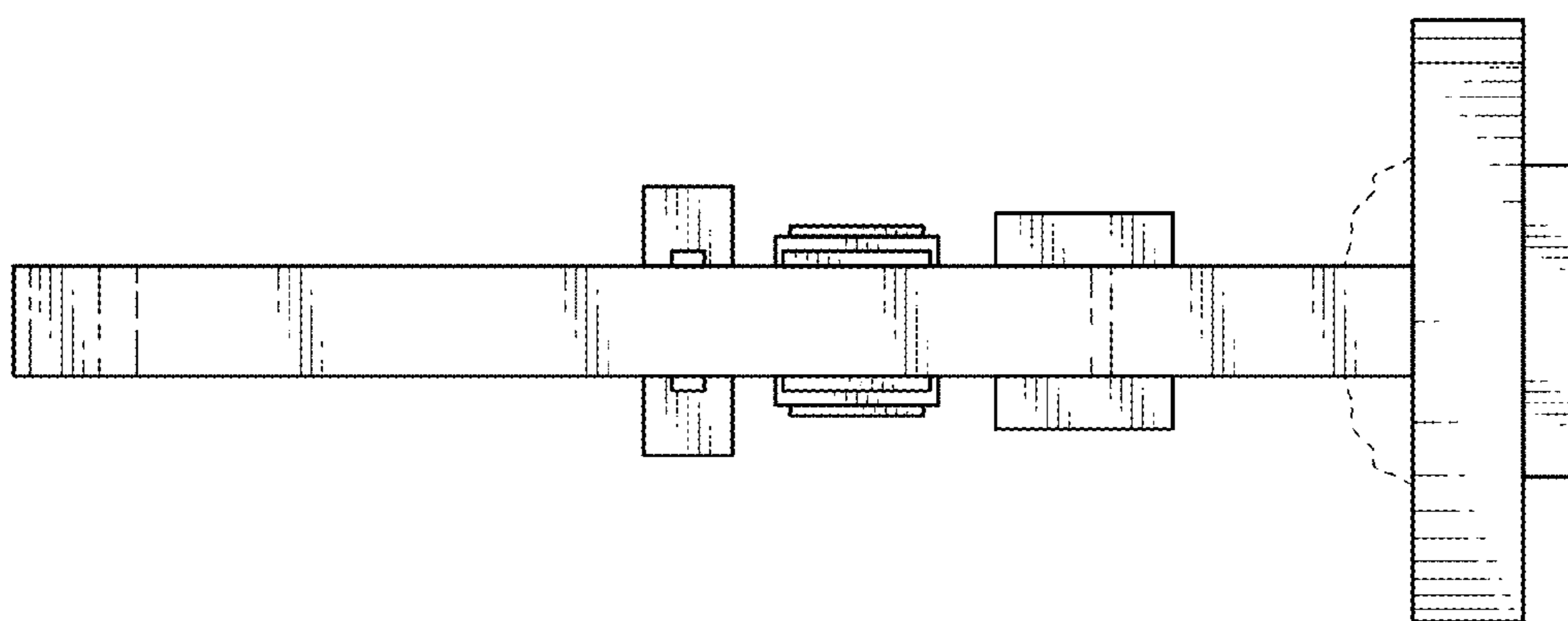

FIG. 3

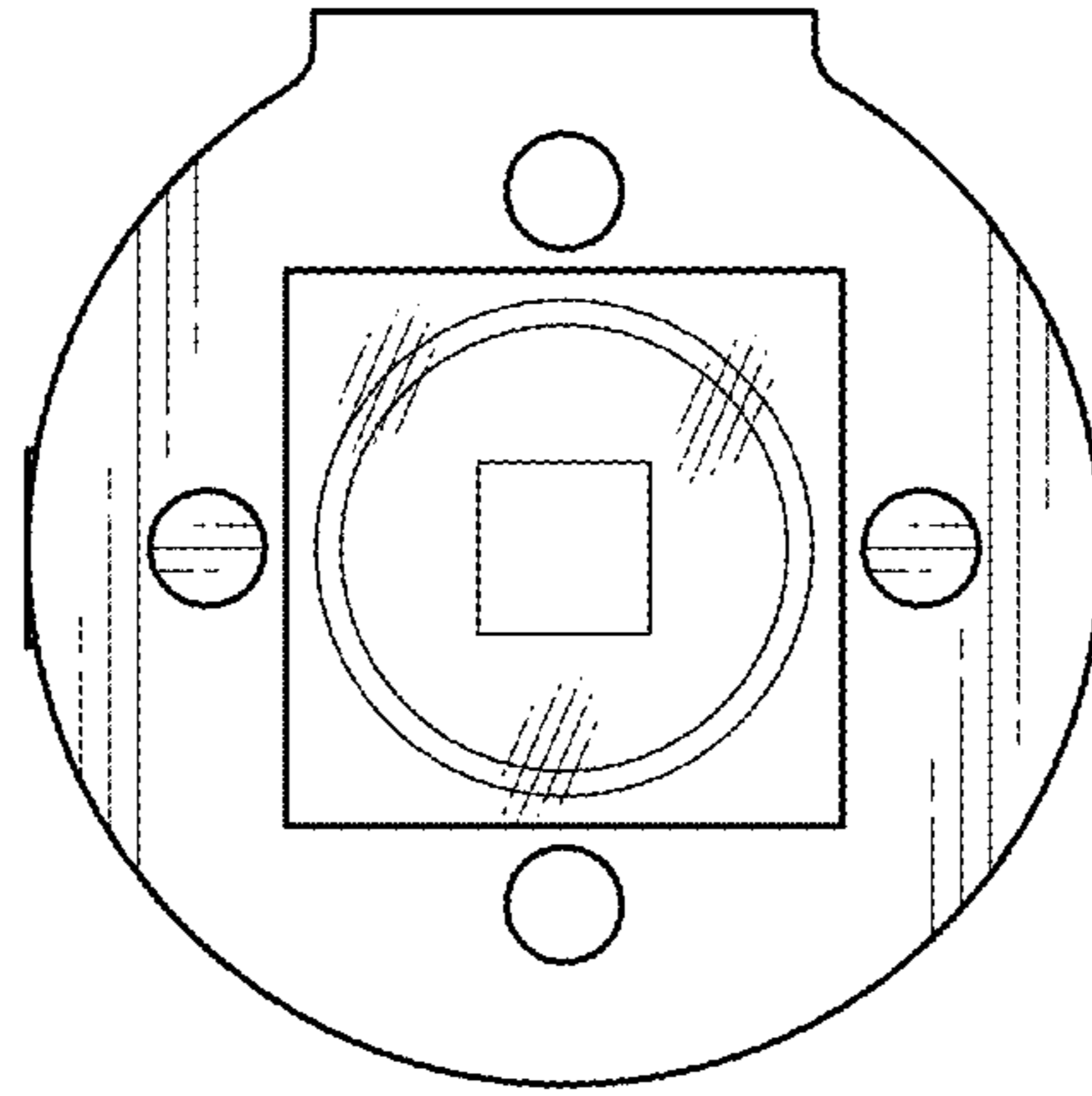

FIG. 4

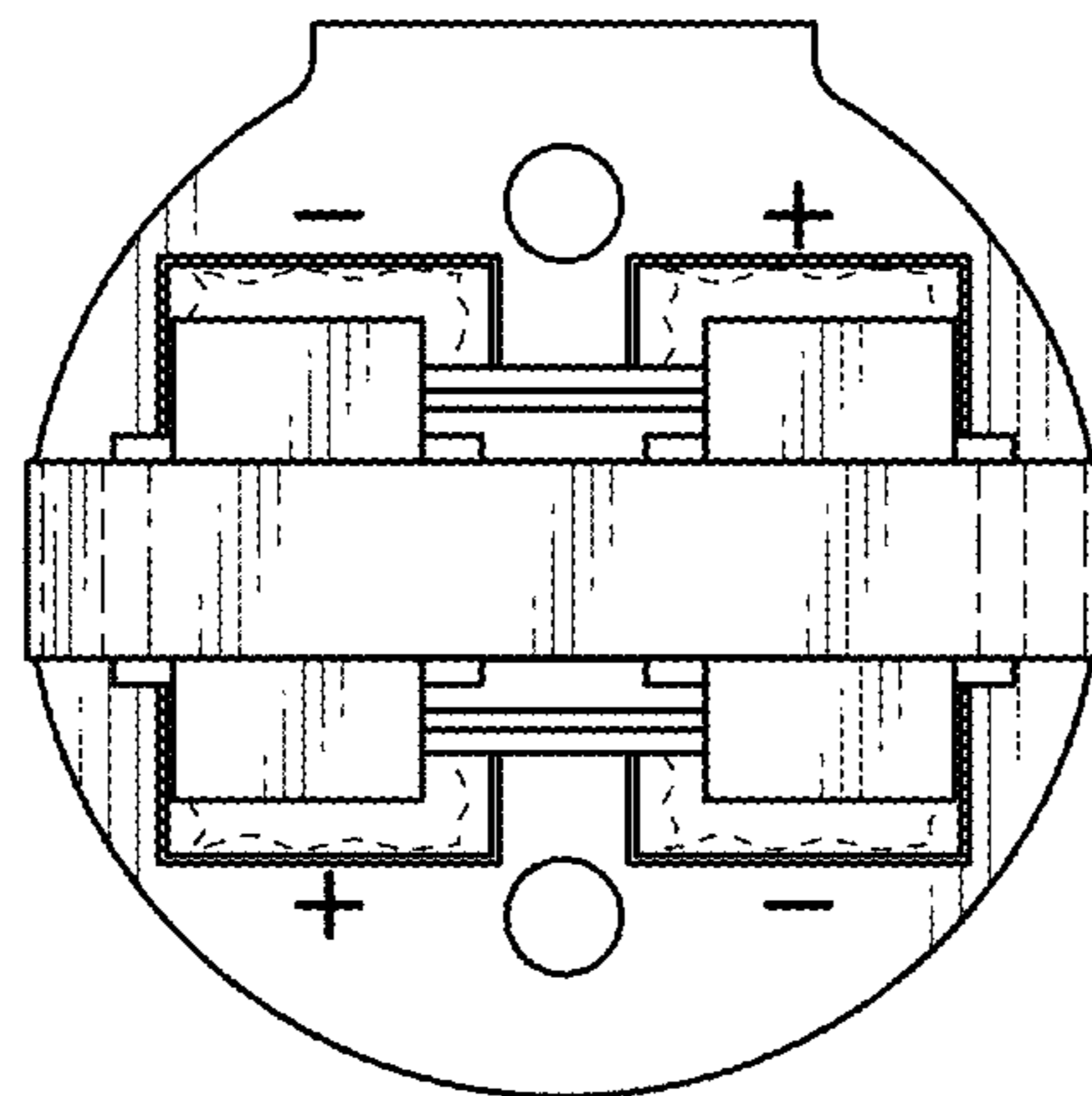

FIG. 5

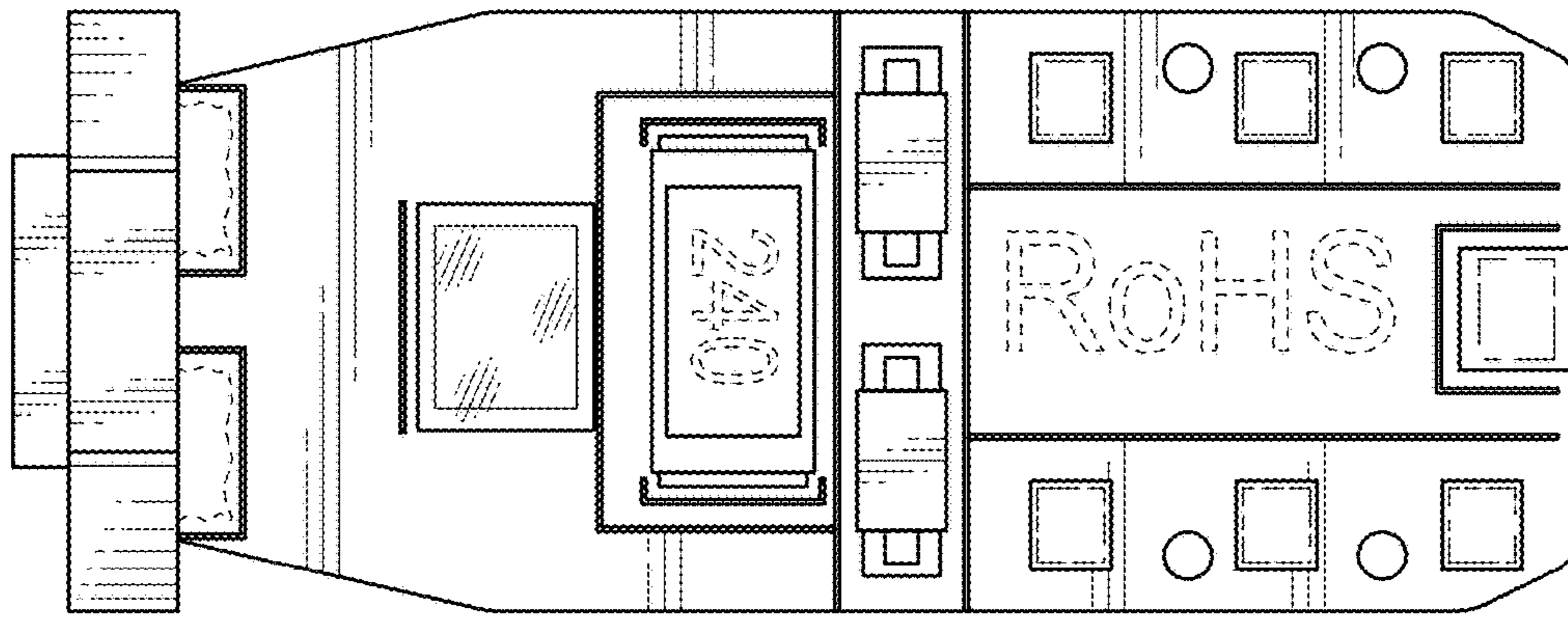

FIG. 6

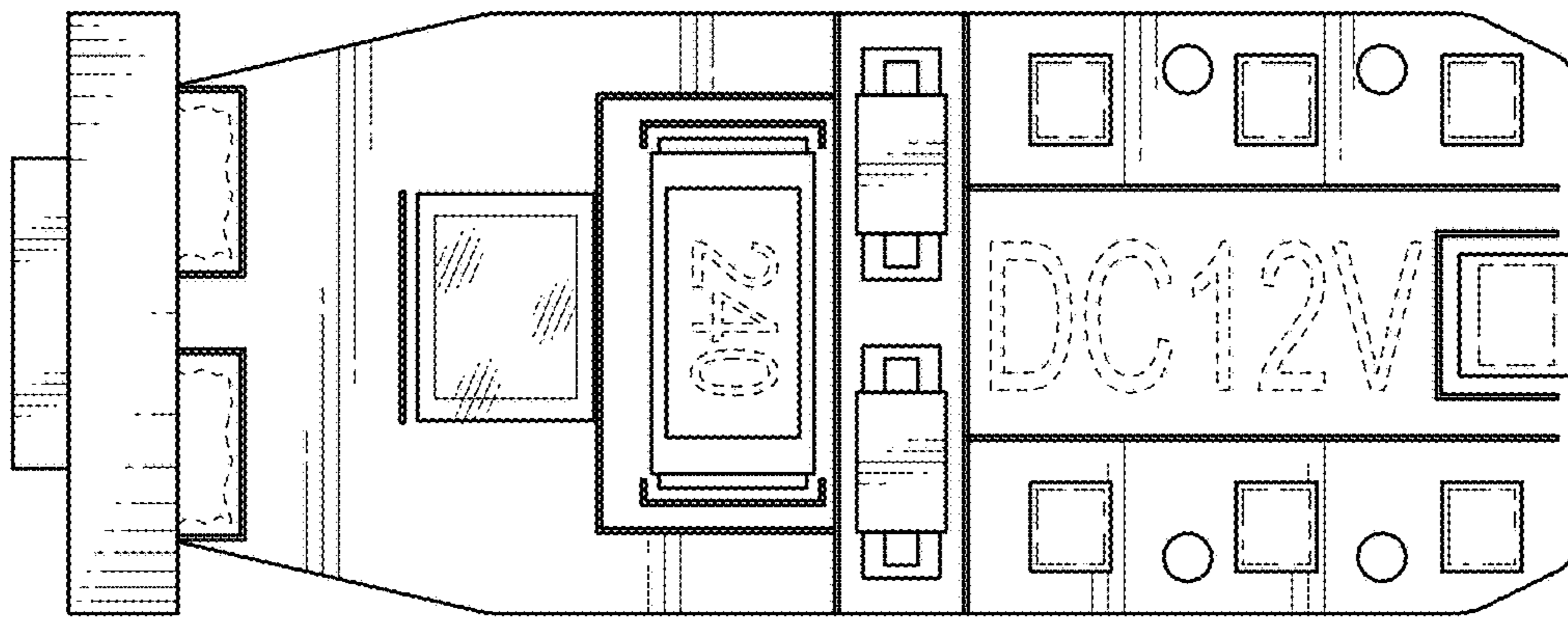

FIG. 7