



US00D814632S

(12) **United States Design Patent**
Shankarsetty

(10) **Patent No.:** **US D814,632 S**

(45) **Date of Patent:** **** Apr. 3, 2018**

(54) **STAPLE CARTRIDGE**

4,216,891 A 8/1980 Behlke
4,244,372 A 1/1981 Kapitanov et al.
4,296,881 A 10/1981 Lee

(71) Applicant: **Covidien LP**, Mansfield, MA (US)

(Continued)

(72) Inventor: **Jeevan Maddur Shankarsetty**,
Bangalore (IN)

FOREIGN PATENT DOCUMENTS

(73) Assignee: **Covidien LP**, Mansfield, MA (US)

JP 2005211651 A 8/2005
JP 2006346445 A 12/2006
JP 2008-055165 A 3/2008

(**) Term: **15 Years**

(21) Appl. No.: **29/581,718**

OTHER PUBLICATIONS

(22) Filed: **Oct. 21, 2016**

Canadian Office Action dated Feb. 1, 2017, issued in Canadian Application No. 171310.

(51) **LOC (11) Cl.** **24-02**

(Continued)

(52) **U.S. Cl.**

USPC **D24/145**

Primary Examiner — Wan Laymon

(58) **Field of Classification Search**

USPC D24/145-147

CPC A61B 17/072; A61B 17/068; A61B

17/07207; A61B 17/064; A61B

2017/07214; A61B 2017/07221; A61B

2017/07228; A61B 2017/07271

See application file for complete search history.

(57) **CLAIM**

The ornamental design for a staple cartridge, as shown and described.

DESCRIPTION

(56) **References Cited**

U.S. PATENT DOCUMENTS

1,158,111 A	10/1915	Ahlheim
2,891,250 A	6/1959	Hirata
3,080,564 A	3/1963	Strekopitov et al.
3,252,643 A	5/1966	Strekopov et al.
3,269,630 A	8/1966	Fleischer
3,275,211 A	9/1966	Hirsch et al.
3,315,863 A	4/1967	O'Dea
3,494,533 A	2/1970	Green et al.
3,589,589 A	6/1971	Akopov
3,692,224 A	9/1972	Astafiev et al.
3,795,034 A	3/1974	Strekopytov et al.
3,822,818 A	7/1974	Strekopytov et al.
3,935,981 A	2/1976	Akopov et al.
3,949,923 A	4/1976	Akopov et al.
4,047,654 A	9/1977	Alvarado

FIG. 1 is a front, perspective view of a surgical stapler including a staple cartridge in accordance with the present design;

FIG. 2 is an enlarged front, perspective view of the staple cartridge shown in FIG. 1;

FIG. 3 is a top view of the staple cartridge of FIG. 2;

FIG. 4 is a left side view of the staple cartridge of FIG. 2;

FIG. 5 is a right side view of the staple cartridge of FIG. 2;

FIG. 6 is a bottom view of the staple cartridge of FIG. 2;

FIG. 7 is a front view of the staple cartridge of FIG. 2; and,

FIG. 8 is a back view of the staple cartridge of FIG. 2.

The broken line showing of staple cartridge is included for the purpose of illustrating portions of the article and forms no part of the claimed design.

1 Claim, 5 Drawing Sheets

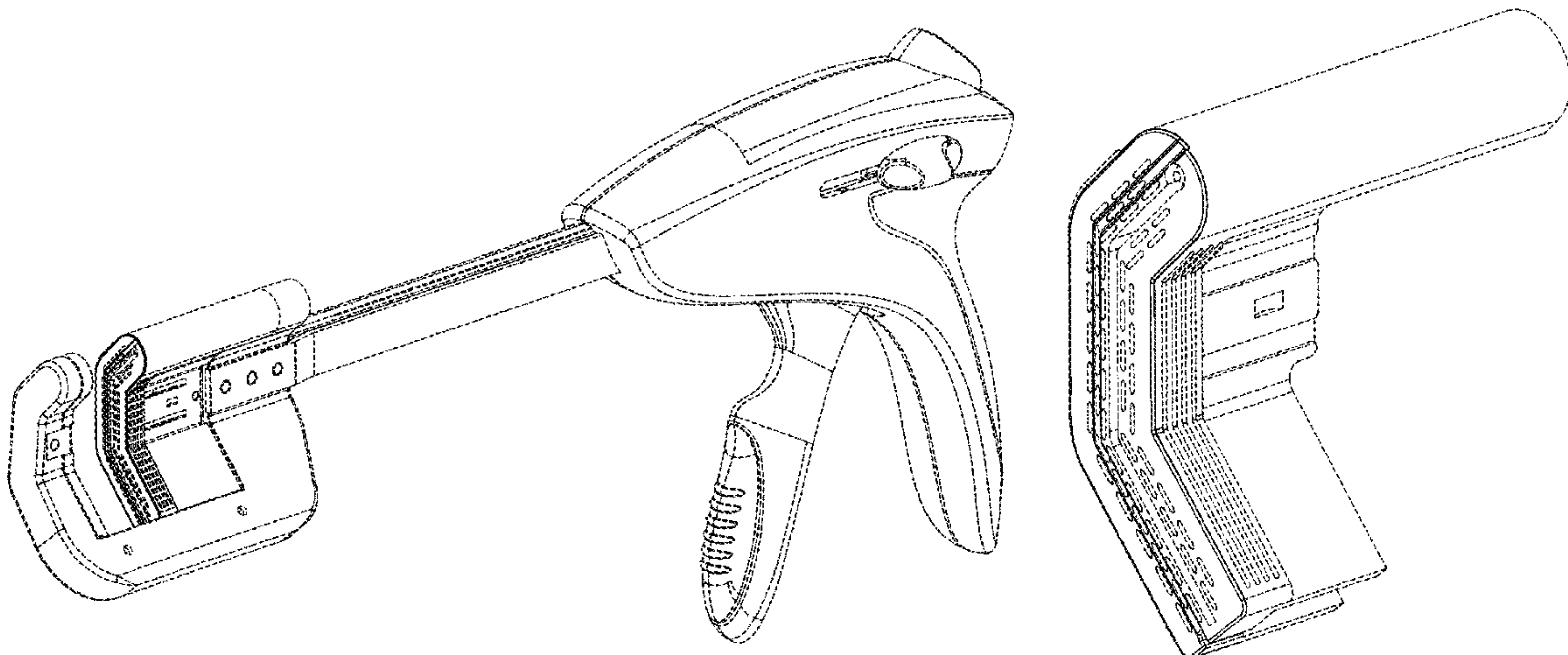

(56)

References Cited

U.S. PATENT DOCUMENTS

4,305,539 A	12/1981	Korolkov et al.	5,465,894 A	11/1995	Clark et al.
4,354,628 A	10/1982	Green	5,470,006 A	11/1995	Rodak
4,378,901 A	4/1983	Akopov et al.	5,470,008 A	11/1995	Rodak
4,383,634 A	5/1983	Green	5,470,009 A	11/1995	Rodak
4,402,444 A	9/1983	Green	5,497,934 A	3/1996	Brady et al.
4,415,112 A	11/1983	Green	5,503,320 A	4/1996	Webster et al.
D273,513 S	4/1984	Spreckelmeier	5,509,596 A	4/1996	Green et al.
4,442,964 A	4/1984	Becht	5,542,594 A	8/1996	McKean et al.
4,470,533 A	9/1984	Schuler	5,547,117 A	8/1996	Hamblin et al.
4,475,679 A	10/1984	Fleury, Jr.	5,558,266 A	9/1996	Green et al.
4,485,811 A	12/1984	Chernousov et al.	5,579,978 A	12/1996	Green et al.
4,506,670 A	3/1985	Crossley	5,580,067 A	12/1996	Hamblin et al.
4,506,671 A	3/1985	Green	5,603,443 A	2/1997	Clark et al.
4,508,253 A	4/1985	Green	5,605,272 A	2/1997	Witt et al.
4,522,327 A	6/1985	Korthoff et al.	5,605,273 A	2/1997	Hamblin et al.
4,527,724 A	7/1985	Chow et al.	5,607,094 A	3/1997	Clark et al.
4,530,453 A	7/1985	Green	5,615,820 A	4/1997	Viola
4,550,870 A	11/1985	Krumme et al.	5,641,111 A	6/1997	Ahrens et al.
4,566,620 A	1/1986	Green et al.	5,678,748 A	10/1997	Plyley et al.
4,568,009 A	2/1986	Green	5,697,543 A	12/1997	Burdorff
4,573,622 A	3/1986	Green et al.	5,706,997 A	1/1998	Green et al.
4,580,712 A	4/1986	Green	5,706,998 A	1/1998	Plyley et al.
4,585,153 A	4/1986	Failla et al.	5,732,871 A	3/1998	Clark et al.
4,589,582 A	5/1986	Bilotti	5,735,445 A	4/1998	Vidal et al.
4,602,634 A	7/1986	Barkley	5,794,834 A	8/1998	Hamblin et al.
4,605,001 A	8/1986	Rothfuss et al.	5,810,240 A	9/1998	Robertson
4,605,004 A	8/1986	Di Giovanni et al.	5,855,311 A	1/1999	Hamblin et al.
4,606,344 A	8/1986	Di Giovanni	5,878,937 A	3/1999	Green et al.
4,606,345 A	8/1986	Dorband et al.	5,893,506 A	4/1999	Powell
4,607,636 A	8/1986	Kula et al.	5,894,979 A	4/1999	Powell
4,612,933 A	9/1986	Brinkerhoff et al.	5,964,394 A	10/1999	Robertson
4,617,928 A	10/1986	Alfranca	6,045,560 A	4/2000	McKean et al.
4,632,290 A	12/1986	Green et al.	D441,865 S *	5/2001	Racenet D24/145
4,665,916 A	5/1987	Green	6,638,285 B2	10/2003	Gabbay
4,684,051 A	8/1987	Akopov et al.	6,805,273 B2	10/2004	Bilotti et al.
4,714,187 A	12/1987	Green	6,817,508 B1	11/2004	Racenet et al.
4,715,520 A	12/1987	Roehr, Jr. et al.	6,988,650 B2	1/2006	Schwemberger et al.
D294,518 S *	3/1988	Green D24/145	7,070,083 B2	7/2006	Jankowski
4,728,020 A	3/1988	Green et al.	7,134,587 B2	11/2006	Schwemberger et al.
4,767,044 A	8/1988	Green	7,147,139 B2	12/2006	Schwemberger et al.
4,788,978 A	12/1988	Strekopytov et al.	7,147,140 B2	12/2006	Wukusick et al.
4,802,614 A	2/1989	Green et al.	7,204,404 B2	4/2007	Nguyen et al.
4,805,823 A	2/1989	Rothfuss	7,207,472 B2	4/2007	Wukusick et al.
4,819,853 A	4/1989	Green	7,210,609 B2	5/2007	Leiboff et al.
4,848,637 A	7/1989	Pruitt	7,237,708 B1	7/2007	Guy et al.
4,869,414 A	9/1989	Green et al.	7,275,674 B2	10/2007	Racenet et al.
4,881,544 A	11/1989	Green et al.	RE40,237 E	4/2008	Bilotti et al.
4,881,545 A	11/1989	Isaacs et al.	7,407,076 B2	8/2008	Racenet et al.
4,915,100 A	4/1990	Green	7,431,190 B2	10/2008	Hoffman
4,930,503 A	6/1990	Pruitt	7,522,854 B2	4/2009	Kinouchi et al.
4,938,408 A	7/1990	Bedi et al.	7,549,563 B2	6/2009	Mather et al.
4,941,623 A	7/1990	Pruitt	7,568,605 B2	8/2009	Kruszynski
4,951,861 A	8/1990	Schulze et al.	7,641,092 B2	1/2010	Kruszynski et al.
4,964,559 A	10/1990	Deniega et al.	7,717,312 B2	5/2010	Beetel
5,005,754 A	4/1991	Van Overloop	7,731,073 B2	6/2010	Wixey et al.
5,018,657 A	5/1991	Pedlick et al.	7,735,704 B2	6/2010	Bilotti
5,071,052 A	12/1991	Rodak et al.	7,766,207 B2	8/2010	Mather et al.
5,100,042 A	3/1992	Gravener et al.	7,810,690 B2	10/2010	Bilotti et al.
5,116,349 A	5/1992	Aranyi	8,002,795 B2 *	8/2011	Beetel A61B 17/068 227/175.1
5,137,198 A	8/1992	Nobis et al.	8,016,176 B2	9/2011	Kasvikis et al.
5,172,845 A	12/1992	Tejeiro	8,033,439 B2	10/2011	Racenet et al.
5,190,203 A	3/1993	Rodak	8,231,041 B2	7/2012	Marczyk et al.
5,219,111 A	6/1993	Bilotti et al.	8,328,064 B2 *	12/2012	Racenet A61B 17/072 227/175.2
D338,729 S *	8/1993	Spreckelmeier D24/143	8,371,494 B2 *	2/2013	Racenet A61B 17/072 227/175.1
5,240,163 A	8/1993	Stein et al.	8,424,738 B2	4/2013	Kasvikis
5,344,060 A	9/1994	Gravener et al.	8,499,994 B2	8/2013	D'Arcangelo
5,368,599 A	11/1994	Hirsch et al.	D690,809 S *	10/2013	Hunt D24/145
5,405,073 A	4/1995	Porter	8,561,871 B2 *	10/2013	Rajappa A61B 17/072 227/175.1
D357,981 S *	5/1995	Green D24/145	8,757,467 B2	6/2014	Racenet et al.
5,413,267 A	5/1995	Solyntjes et al.	9,125,651 B2 *	9/2015	Mandakolathur Vasudevan A61B 17/072
5,439,155 A	8/1995	Viola	9,314,264 B2 *	4/2016	Racenet A61B 17/072
5,452,836 A	9/1995	Huitema et al.	9,463,016 B2 *	10/2016	Kasvikis A61B 17/072
5,458,279 A	10/1995	Plyley	2004/0164123 A1	8/2004	Racenet et al.
5,462,215 A	10/1995	Viola et al.	2005/0247752 A1	11/2005	Kelly et al.
5,464,144 A	11/1995	Guy et al.			

(56)

References Cited

U.S. PATENT DOCUMENTS

2005/0247753 A1 11/2005 Kelly et al.
2005/0263563 A1* 12/2005 Racenet A61B 17/072
227/176.1
2006/0163312 A1 7/2006 Viola et al.
2007/0187456 A1 8/2007 Viola et al.
2009/0277948 A1 11/2009 Beardsley et al.
2010/0048988 A1 2/2010 Pastorelli et al.
2010/0249802 A1* 9/2010 May A61B 17/072
606/139
2013/0105554 A1 5/2013 Kostrzewski

OTHER PUBLICATIONS

Notice of Allowance dated Mar. 31, 2017, issued in JP Application
No. 201623794.

* cited by examiner

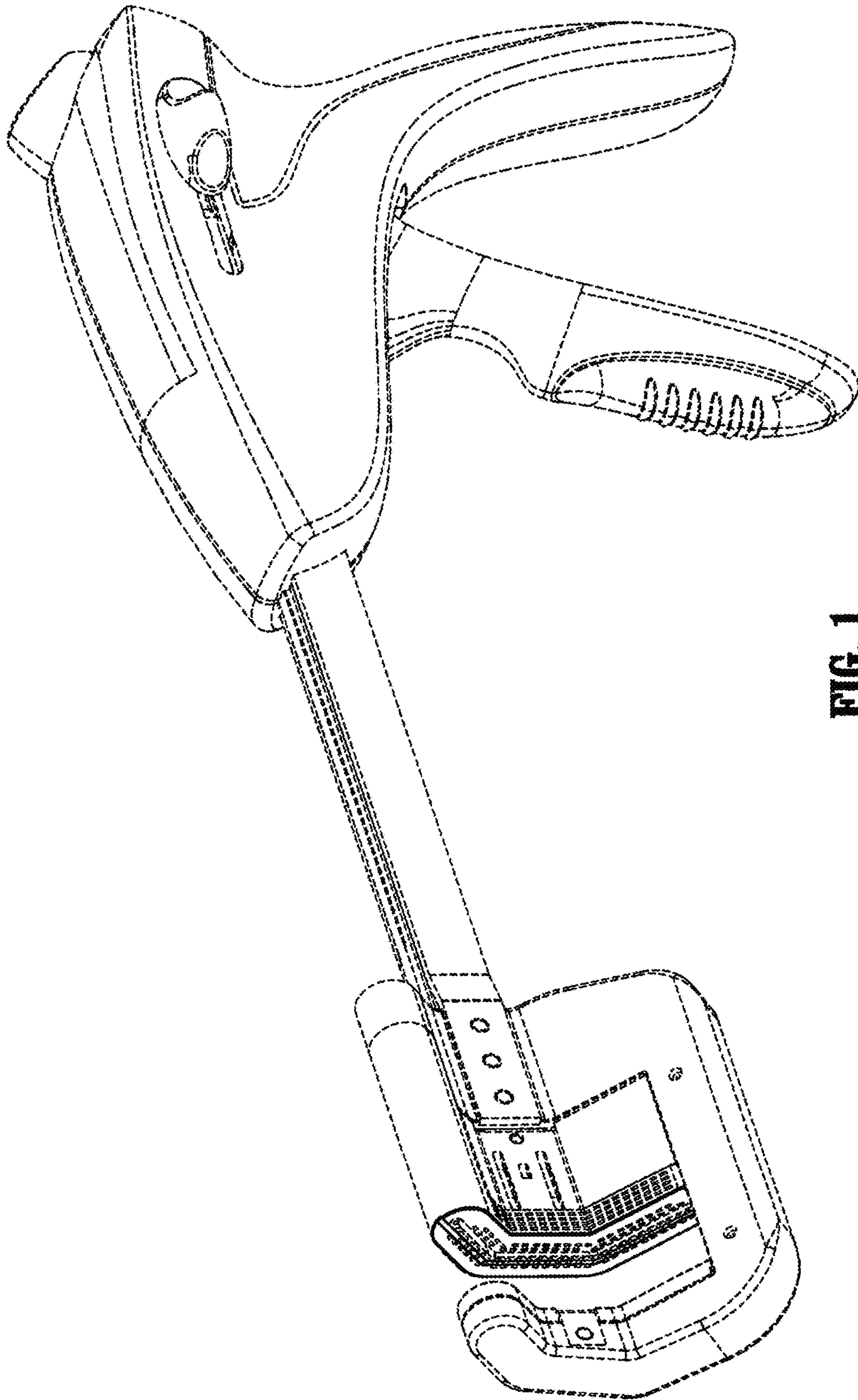

FIG. 1

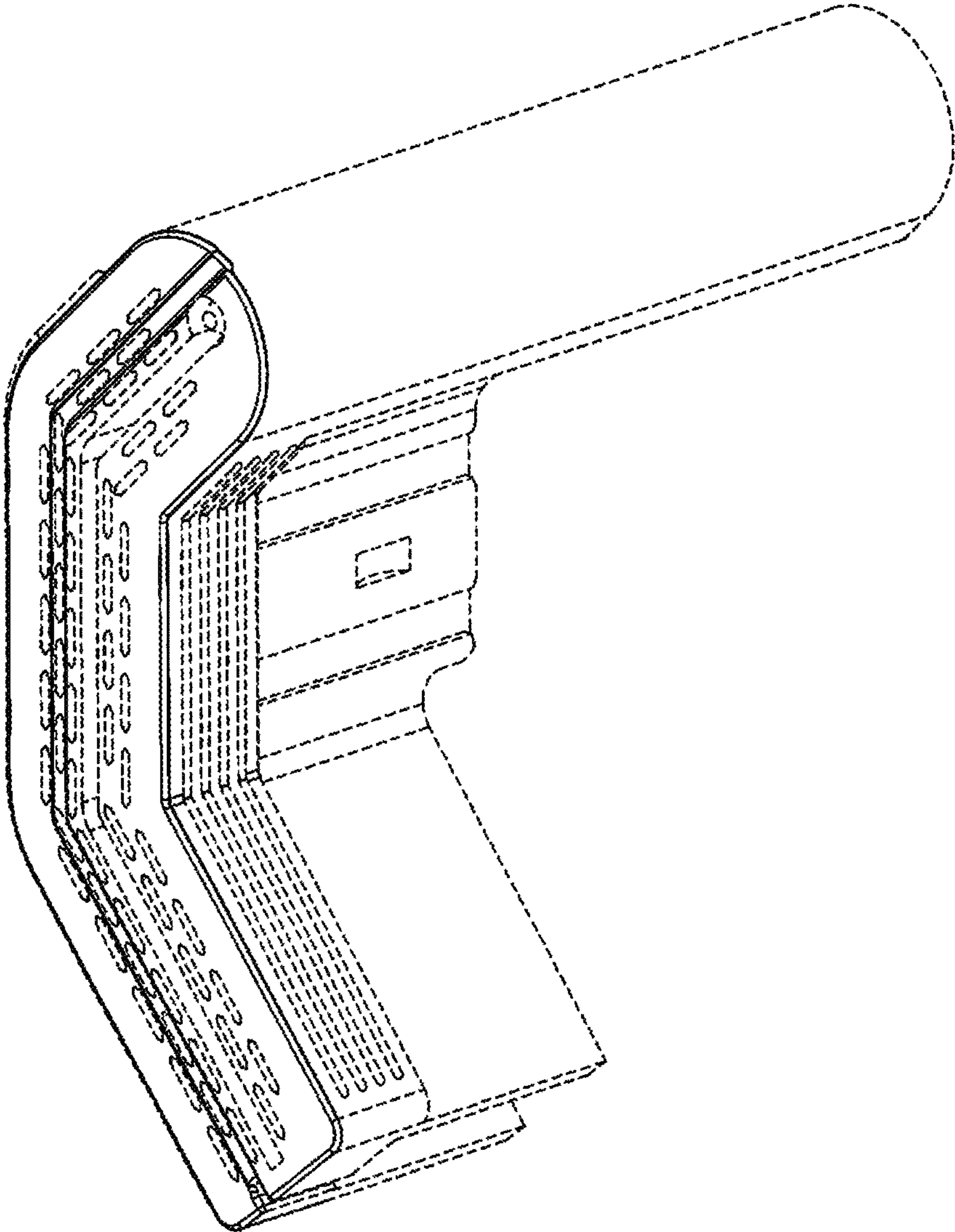

FIG. 2

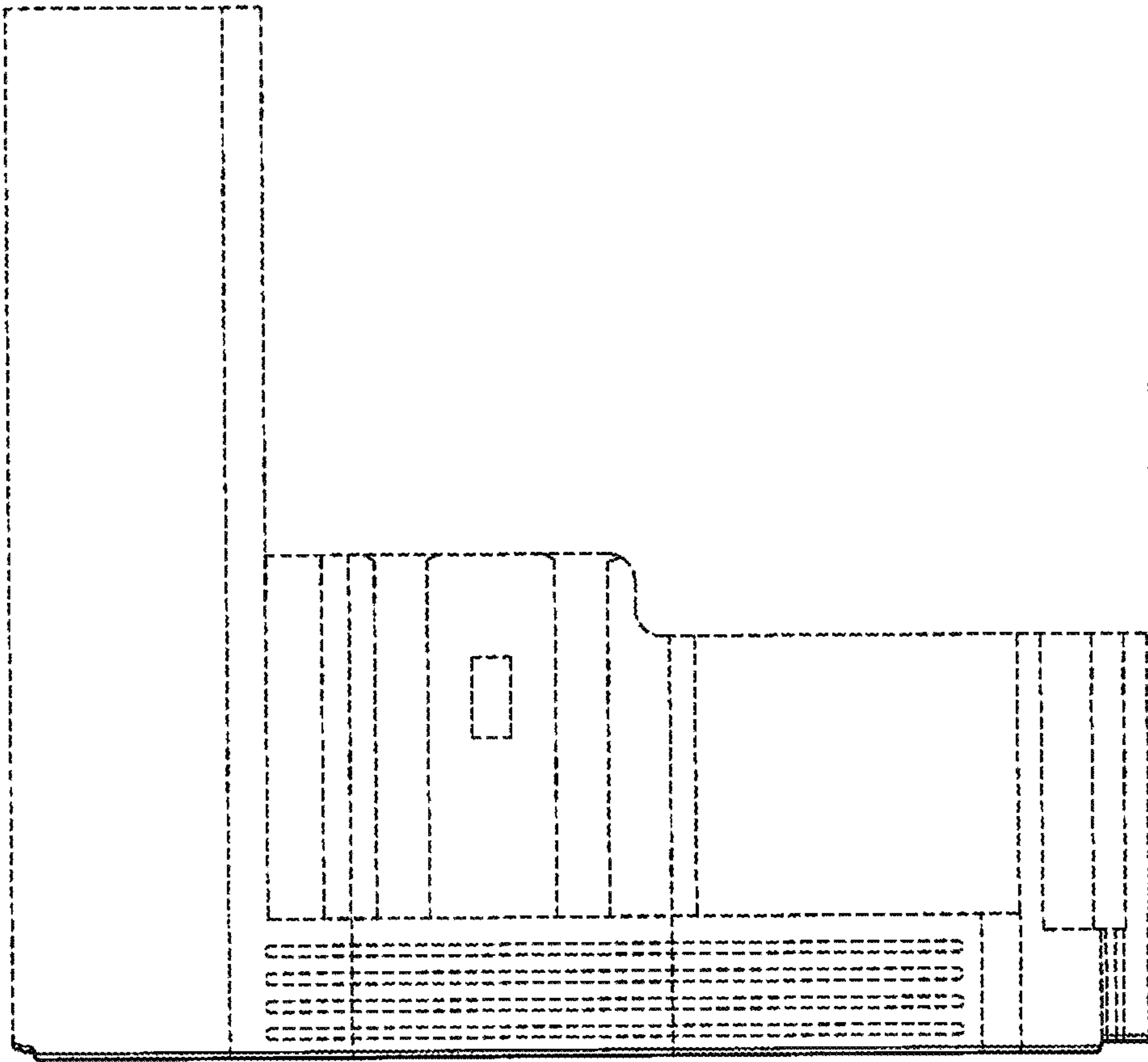

FIG. 4

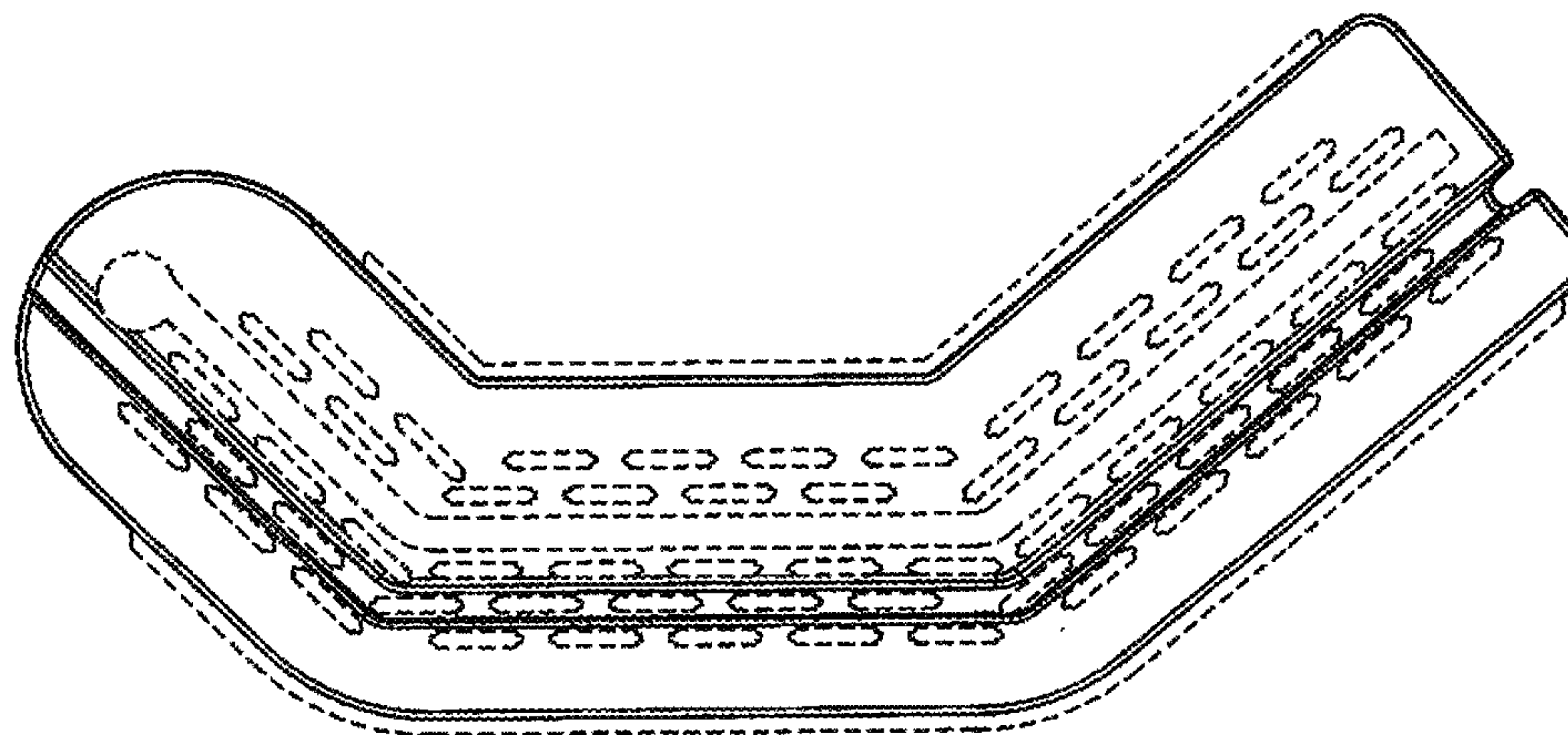

FIG. 3

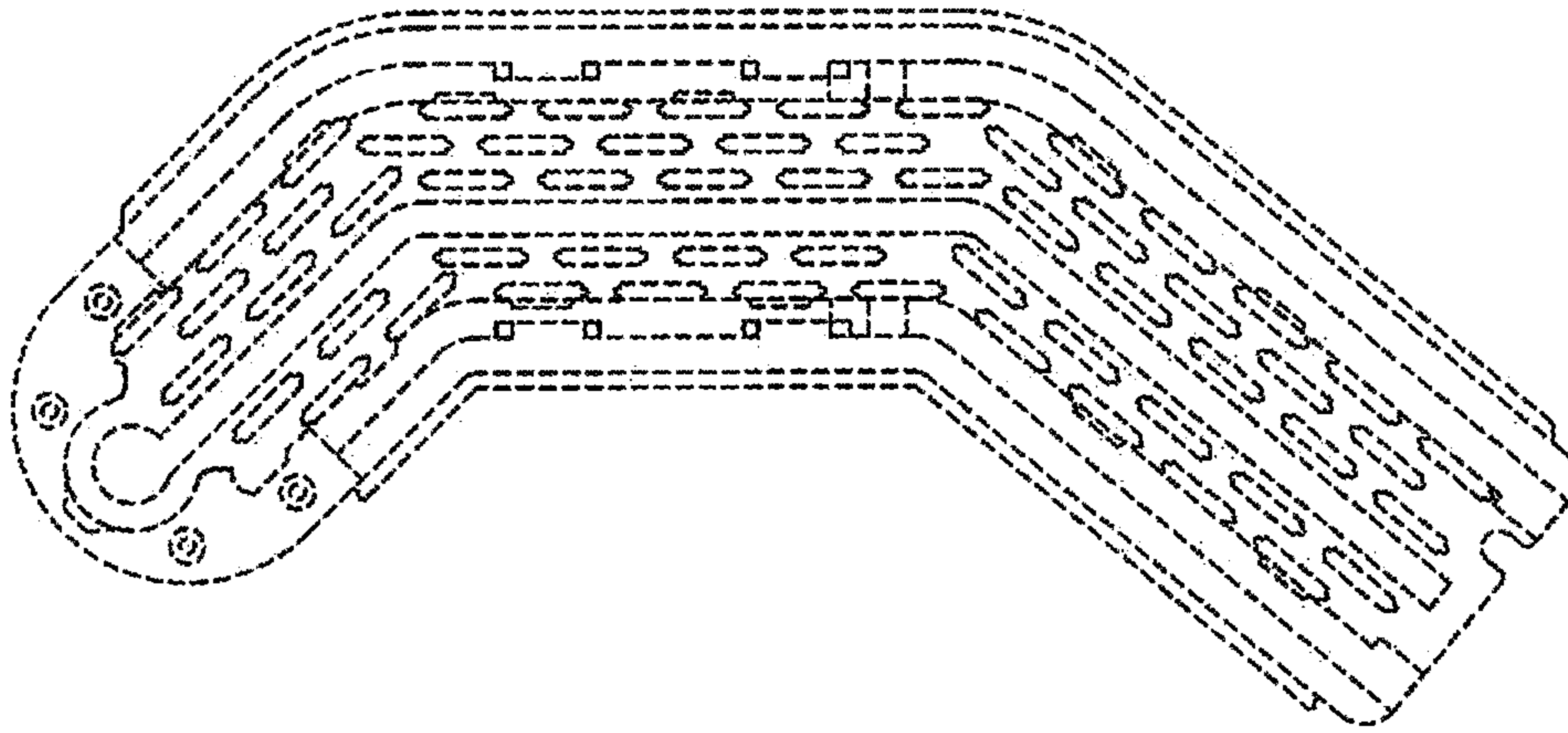

FIG. 6

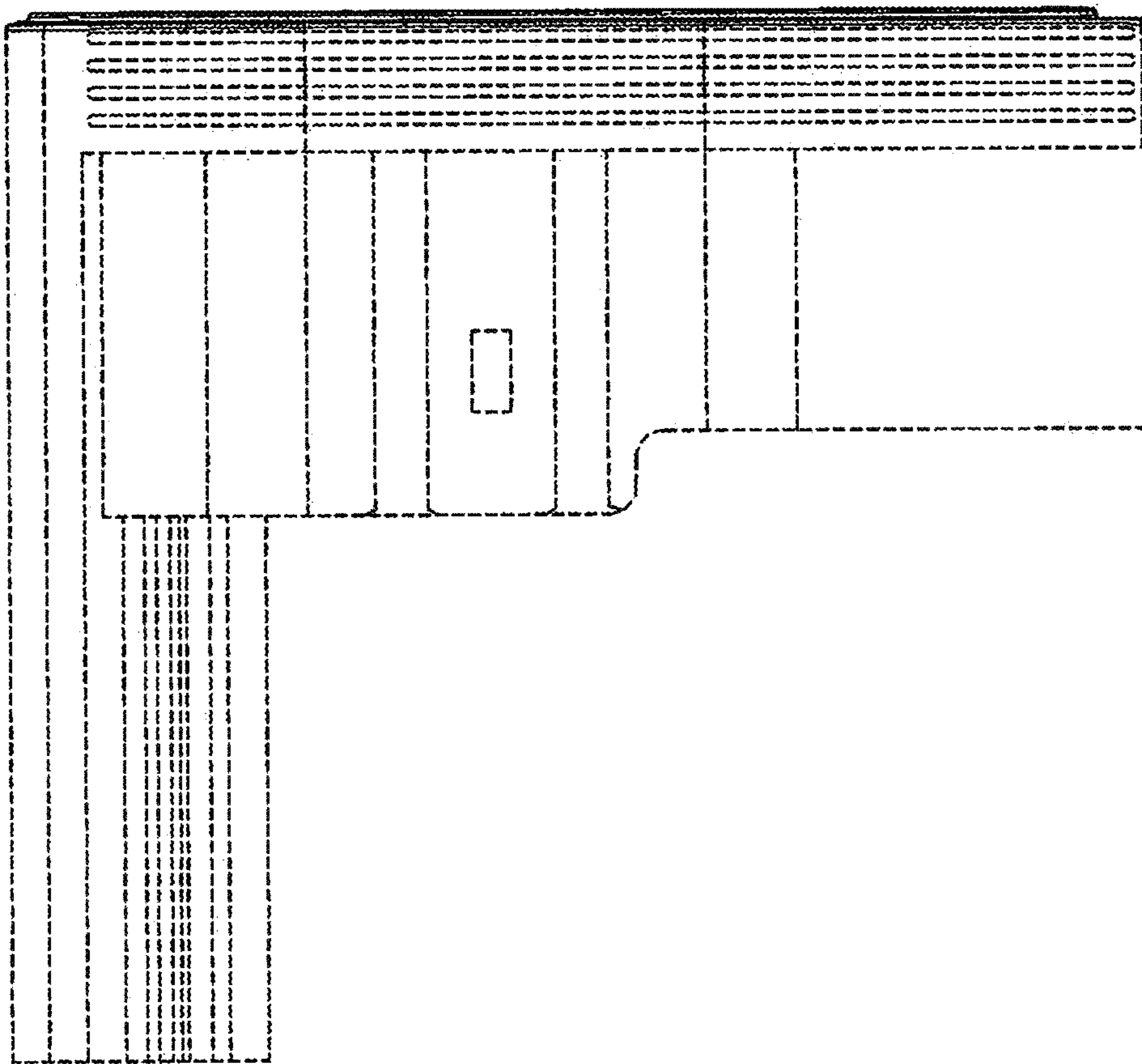

FIG. 5

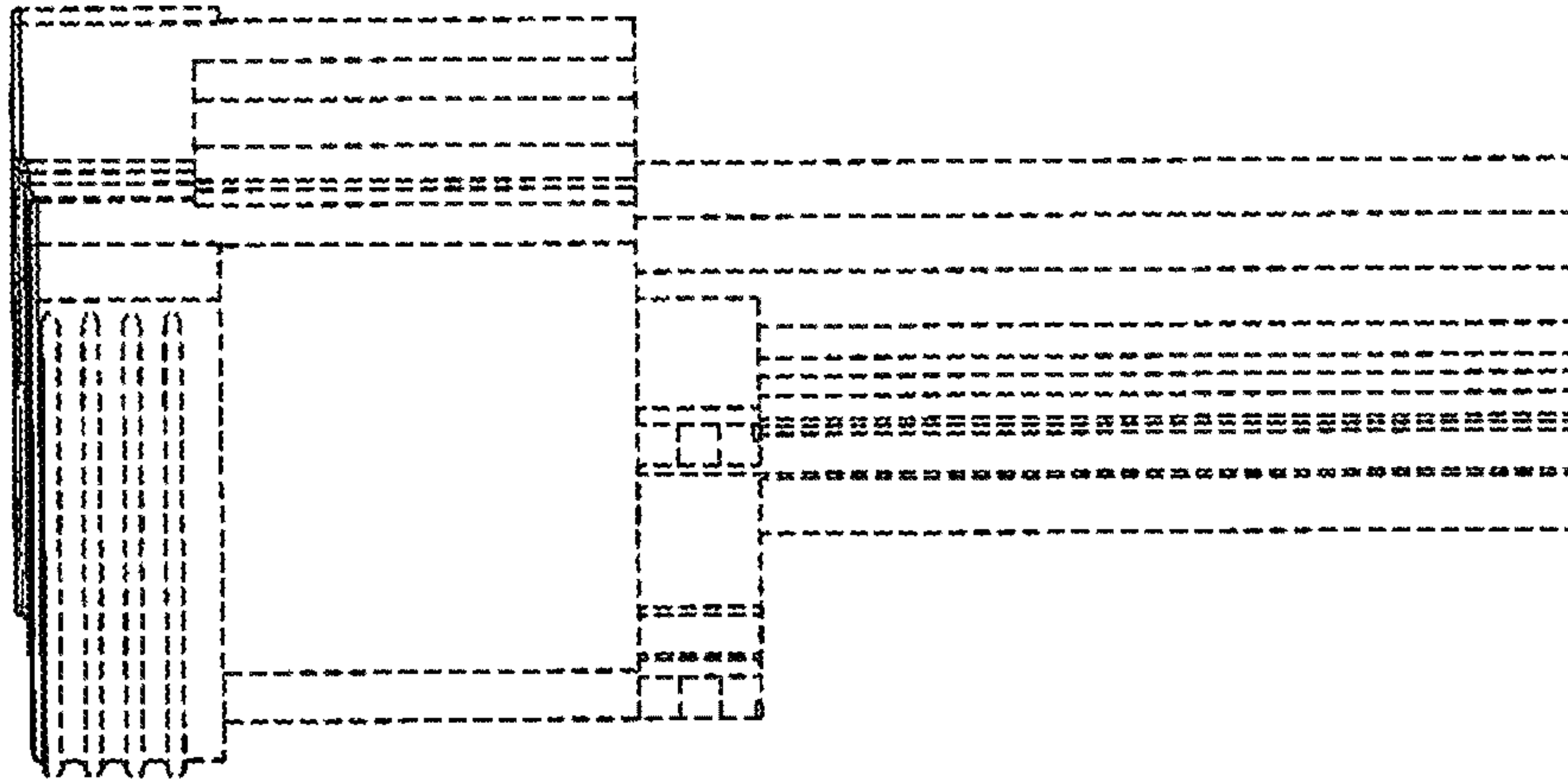

FIG. 8

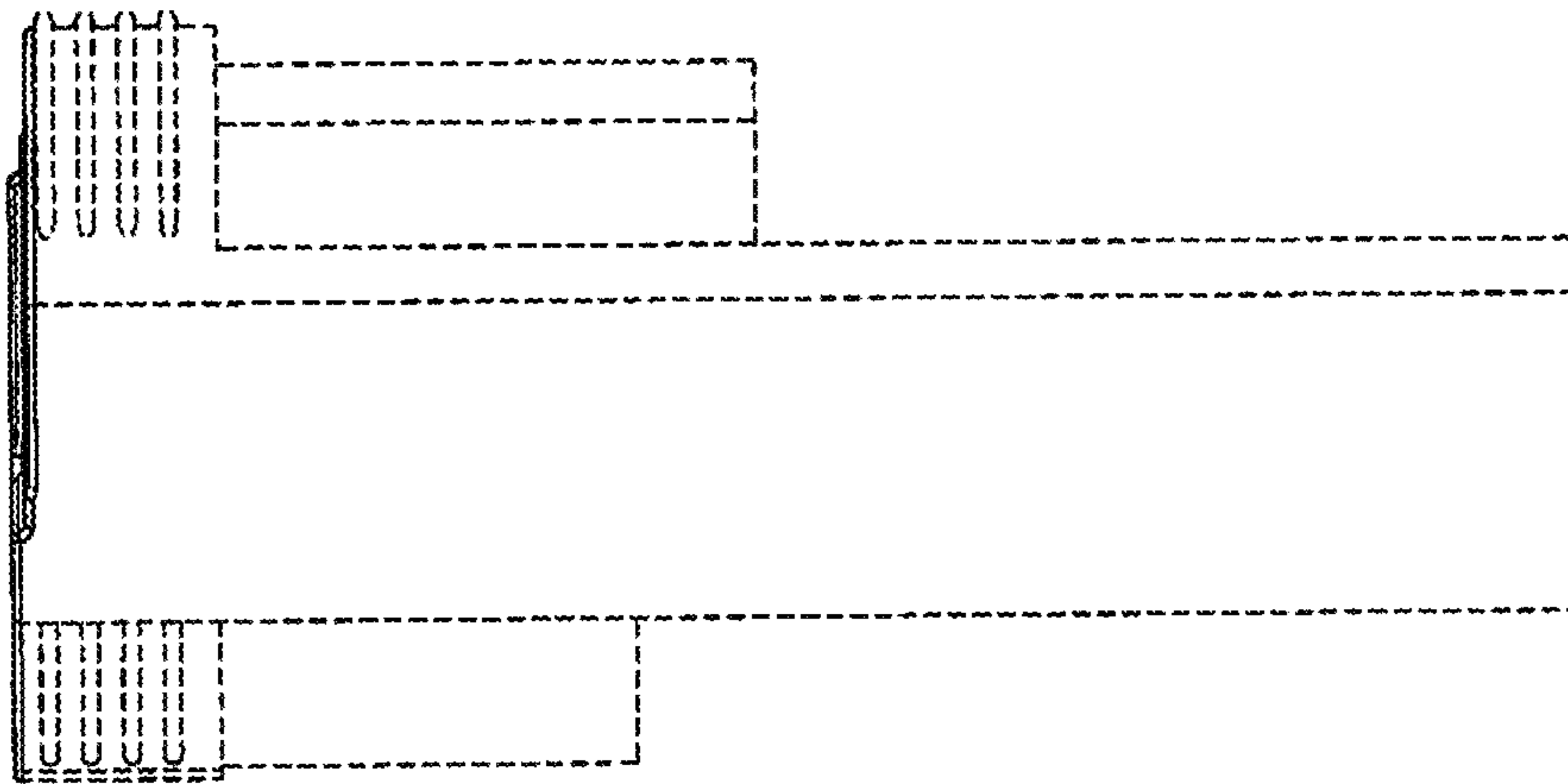

FIG. 7