



US00D814348S

(12) **United States Design Patent**  
**Boyce, II**

(10) **Patent No.:** **US D814,348 S**  
(45) **Date of Patent:** **\*\* Apr. 3, 2018**

(54) **GOLF CART REAR FLIP SEAT KIT**

(71) Applicant: **Red Hawk LLC**, Baltimore, MD (US)

(72) Inventor: **E. Gillet Boyce, II**, Baltimore, MD (US)

(73) Assignee: **Red Hawk LLC**, Baltimore, MD (US)

(\*\*) Term: **15 Years**

(21) Appl. No.: **29/566,247**

(22) Filed: **May 27, 2016**

(51) **LOC (11) Cl.** ..... **12-02**

(52) **U.S. Cl.**  
USPC ..... **D12/16**

(58) **Field of Classification Search**  
USPC ..... D6/362; D12/1, 14, 16, 82, 86, 87, 88,  
D12/92, 96, 107, 112, 113, 164, 173;  
D15/10; D21/551, 556, 559; D34/15  
(Continued)

(56) **References Cited**

**U.S. PATENT DOCUMENTS**

8,191,966 B1 \* 6/2012 Longenette ..... B60N 2/6018  
297/218.1  
9,211,012 B1 \* 12/2015 Wilson, II ..... A47C 7/66  
(Continued)

**OTHER PUBLICATIONS**

EZGO TXT Golf Cart Rear Flip, posted at Amazon.com, posted on Sep. 7, 2012, [online], [site visited Feb. 23, 2017]. Available from Internet, <<https://www.amazon.com/EZGO-Golf-Cart-Rear-Flip/dp/B0050679GW>>.\*

(Continued)

*Primary Examiner* — Mary Ann Calabrese

*Assistant Examiner* — Catherine Ho

(74) *Attorney, Agent, or Firm* — Miles & Stockbridge P.C.; David R. Schaffer

(57) **CLAIM**

The ornamental design for a golf cart rear flip seat kit, as shown and described.

**DESCRIPTION**

FIG. 1 is a front, top perspective view showing my new design for a golf cart rear flip seat kit in a folded position. FIG. 2 is a front view of the golf cart rear flip seat kit in a folded position.

FIG. 3 is a left view of the golf cart rear flip seat kit in a folded position.

FIG. 4 is an enlarged fragment of the step portion of the golf cart rear flip seat kit in a folded position shown in FIG. 3.

FIG. 5 is a back side view of the golf cart rear flip seat kit in a folded position.

FIG. 6 is a right side view of the golf cart rear flip seat kit in a folded position.

FIG. 7 is a top side view of the golf cart rear flip seat kit in a folded position.

FIG. 8 is a bottom side view of the golf cart rear flip seat kit in a folded position.

FIG. 9 is an enlarged fragment of the top raised design on the step portion of the golf cart rear flip seat kit in a folded position shown in FIG. 7.

FIG. 10 is an enlarged fragment of the top raised design on the step portion of the golf cart rear flip seat kit in a folded position shown in FIG. 1.

FIG. 11 is a front, top perspective view showing my new design for a golf cart rear flip seat kit in an unfolded position.

FIG. 12 is a front view of the golf cart rear flip seat kit in an unfolded position.

FIG. 13 is a left view of the golf cart rear flip seat kit in an unfolded position.

FIG. 14 is an enlarged fragment of the details of side edges of a step portion of the golf cart rear flip seat kit in an unfolded position shown in FIG. 13.

FIG. 15 is a back side view of the golf cart rear flip seat kit in an unfolded position.

FIG. 16 is a right side view of the golf cart rear flip seat kit in an unfolded position.

FIG. 17 is a top side view of the golf cart rear flip seat kit in an unfolded position.

(Continued)

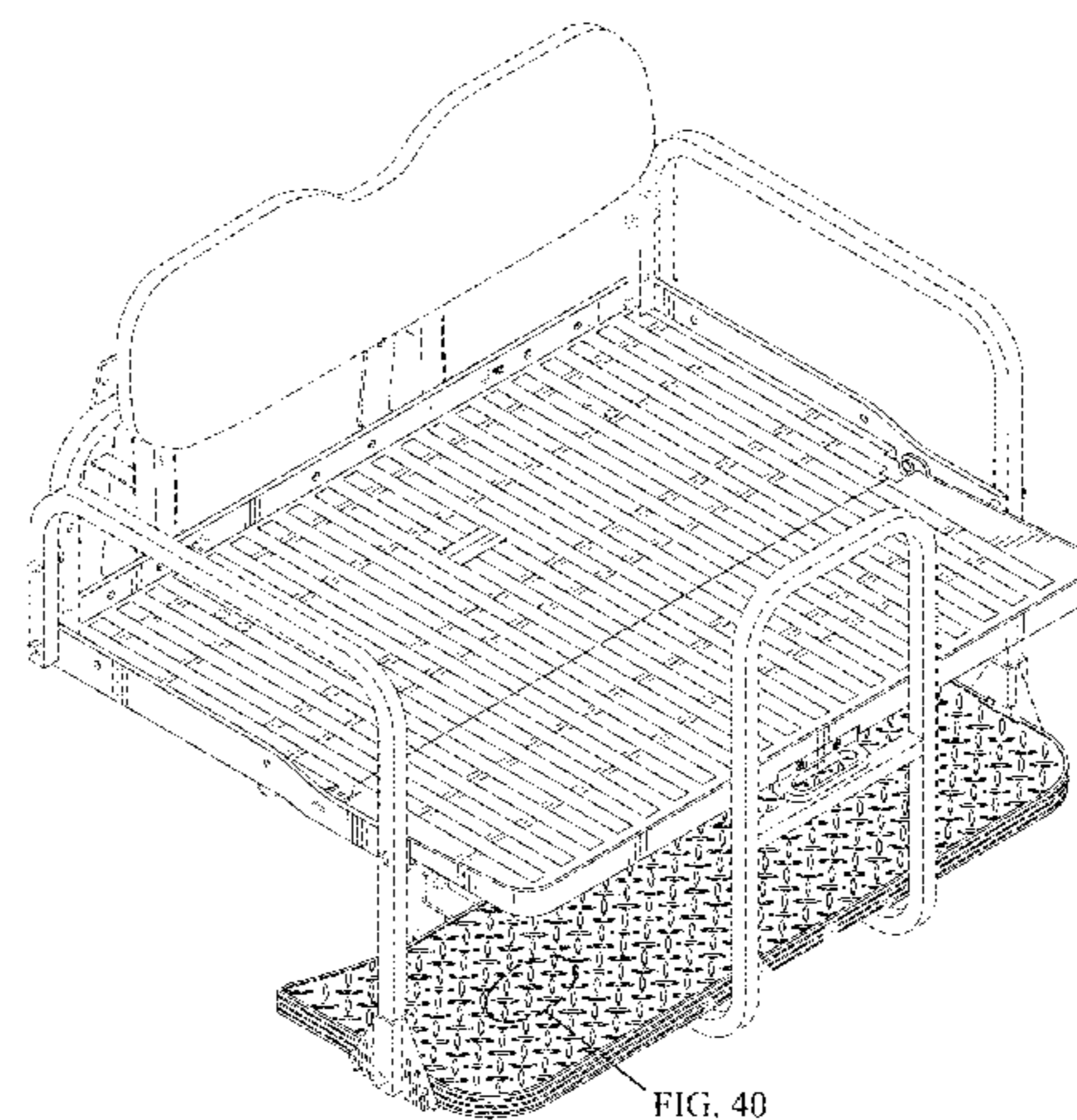
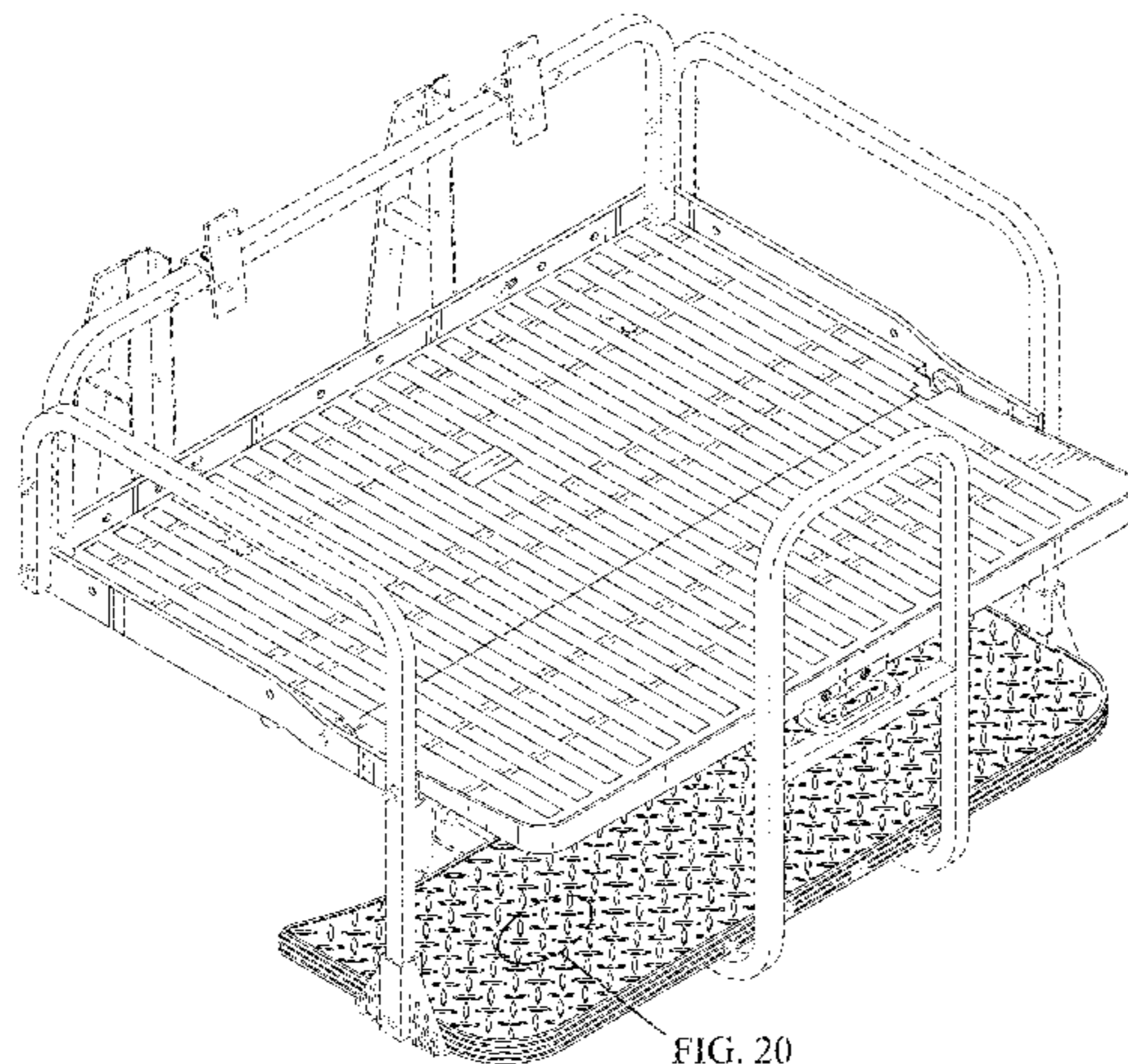

FIG. 18 is a bottom side view of the golf cart rear flip seat kit in an unfolded position.

FIG. 19 is an enlarged fragment to the top raised design on the step portion of the golf cart rear flip seat kit in an unfolded position.

FIG. 20 is an enlarged fragment of the top raised design on the step portion of the golf cart rear flip seat kit in an unfolded position shown in FIG. 11.

FIG. 21 is a front, top perspective view showing my new design for a golf cart rear flip seat kit in a folded position.

FIG. 22 is a front view of the golf cart rear flip seat kit in a folded position.

FIG. 23 is a left view of the golf cart rear flip seat kit in a folded position.

FIG. 24 is an enlarged fragment of the details of side edges of a step portion of the golf cart rear flip seat kit shown in FIG. 23.

FIG. 25 is a back side view of the golf cart rear flip seat kit in a folded position.

FIG. 26 is a right side view of the golf cart rear flip seat kit in a folded position.

FIG. 27 is a top side view of the golf cart rear flip seat kit in a folded position.

FIG. 28 is a bottom side view of the golf cart rear flip seat kit in a folded position.

FIG. 29 is an enlarged fragment of the top raised design on the step portion of the golf cart rear flip seat kit in a folded position shown as FIG. 27.

FIG. 30 is an enlarged fragment of the top raised design on the step portion of the golf cart rear flip seat kit in a folded position shown in FIG. 21.

FIG. 31 is a front, top perspective view showing my new design for a golf cart rear flip seat kit in an unfolded position.

FIG. 32 is a front view of the golf cart rear flip seat kit in an unfolded position.

FIG. 33 is a left view of the golf cart rear flip seat kit in an unfolded position.

FIG. 34 is an enlarged fragment of the details of side edges of a step portion of the golf cart rear flip seat kit in an unfolded position.

FIG. 35 is a back side view of the golf cart rear flip seat kit in an unfolded position.

FIG. 36 is a right side view of the golf cart rear flip seat kit in an unfolded position.

FIG. 37 is a top side view of the golf cart rear flip seat kit in an unfolded position.

FIG. 38 is a bottom side view of the golf cart rear flip seat kit in an unfolded position.

FIG. 39 is an enlarged fragment the top raised design on the step portion of the golf cart rear flip seat kit in an unfolded position; and,

FIG. 40 is an enlarged fragment of the top raised design on the step portion of the golf cart rear flip seat kit in an unfolded position.

The broken line position of the figure drawings is included to show portions of the article that form no part of the claimed design.

**1 Claim, 36 Drawing Sheets**

(58) **Field of Classification Search**

CPC ... B60N 2/02; B60N 2/38; B60N 2/46; B60N 2/58; B60N 2/70; B60N 2/0292; B60N 2/30; B60N 2/005; B60N 2/3095; B60N 2/305; B60N 2/3013; A63B 55/00; A63B 55/60; B60R 9/08; B60R 9/06; B62B 3/04

See application file for complete search history.

(56) **References Cited**

U.S. PATENT DOCUMENTS

2005/0264048	A1*	12/2005	Collins	.....	B60N 2/3095 297/188.01
2007/0057526	A1*	3/2007	Bigelow	.....	B60N 2/3095 296/65.03
2008/0211270	A1*	9/2008	Hu	.....	B60N 2/005 297/188.08
2015/0102630	A1*	4/2015	Guzzetta	.....	B60J 5/065 296/147
2015/0196815	A1*	7/2015	Tian	.....	A63B 55/60 224/274
2016/0176315	A1*	6/2016	Moore	.....	B60N 2/0292 297/108

OTHER PUBLICATIONS

Yamaha G16/22 Golf Cart, posted at Amazon.com, posted on Dec. 10, 2015, [online], [site visited Feb. 23, 2017]. Available from Internet, <<https://www.amazon.com/Yamaha-Golf-Cart-American-Rear/dp/B016J6OXRY>>.\*

Rear Flip Seat for Club Car, posted at Youtube.com, posted on Jan. 19, 2013, [online], [site visited Feb. 23, 2017]. Available from Internet, <<https://www.youtube.com/watch?v=hyaBJI5-bSw>>.\*

G150 Seat Kit, posted at Youtube.com, posted on May 7, 2015, [online], [site visited Feb. 23, 2017]. Available from Internet, <<https://www.youtube.com/watch?v=R3d91ijl264>>.\*

\* cited by examiner

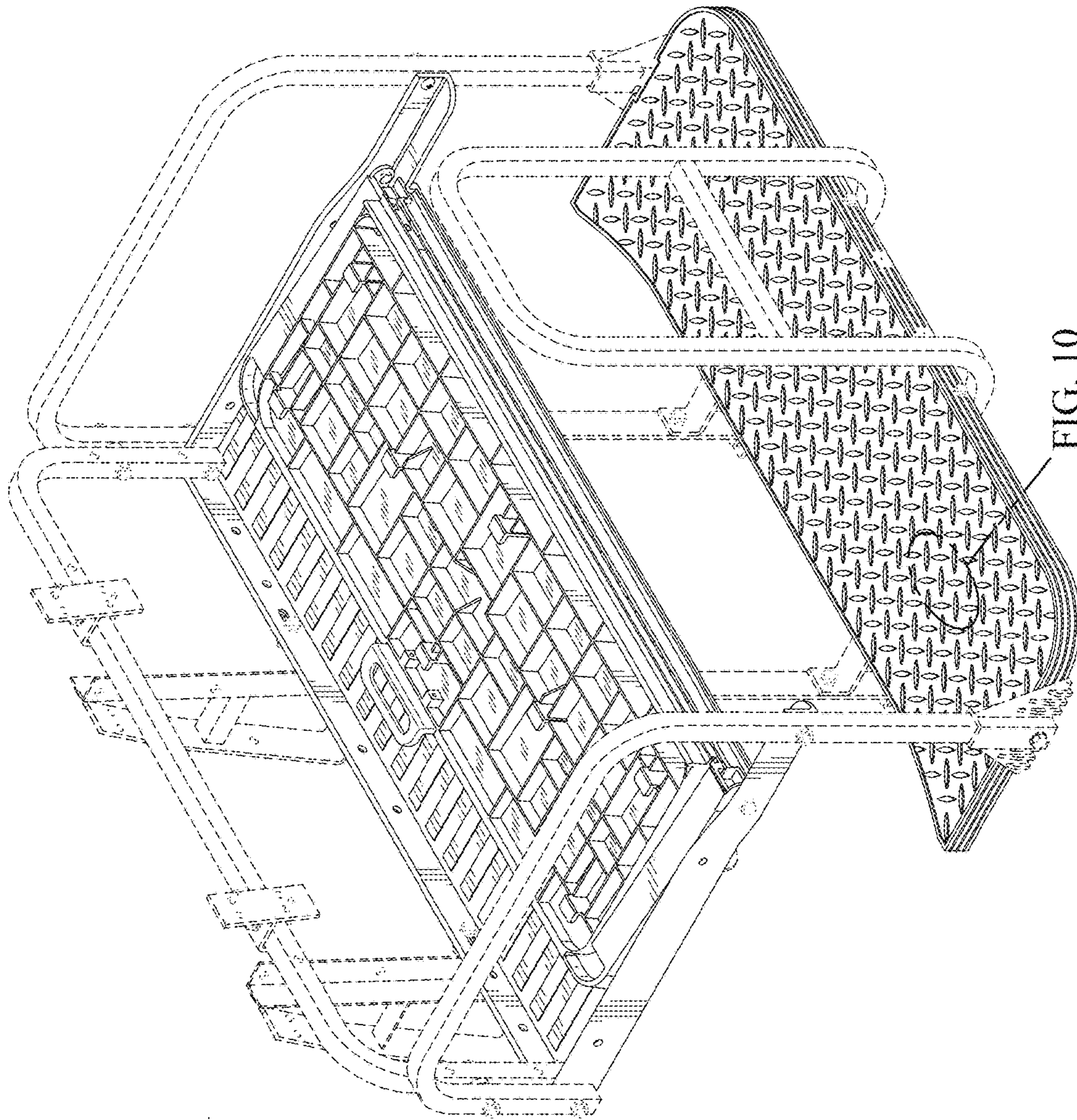

FIG. 1

FIG. 10

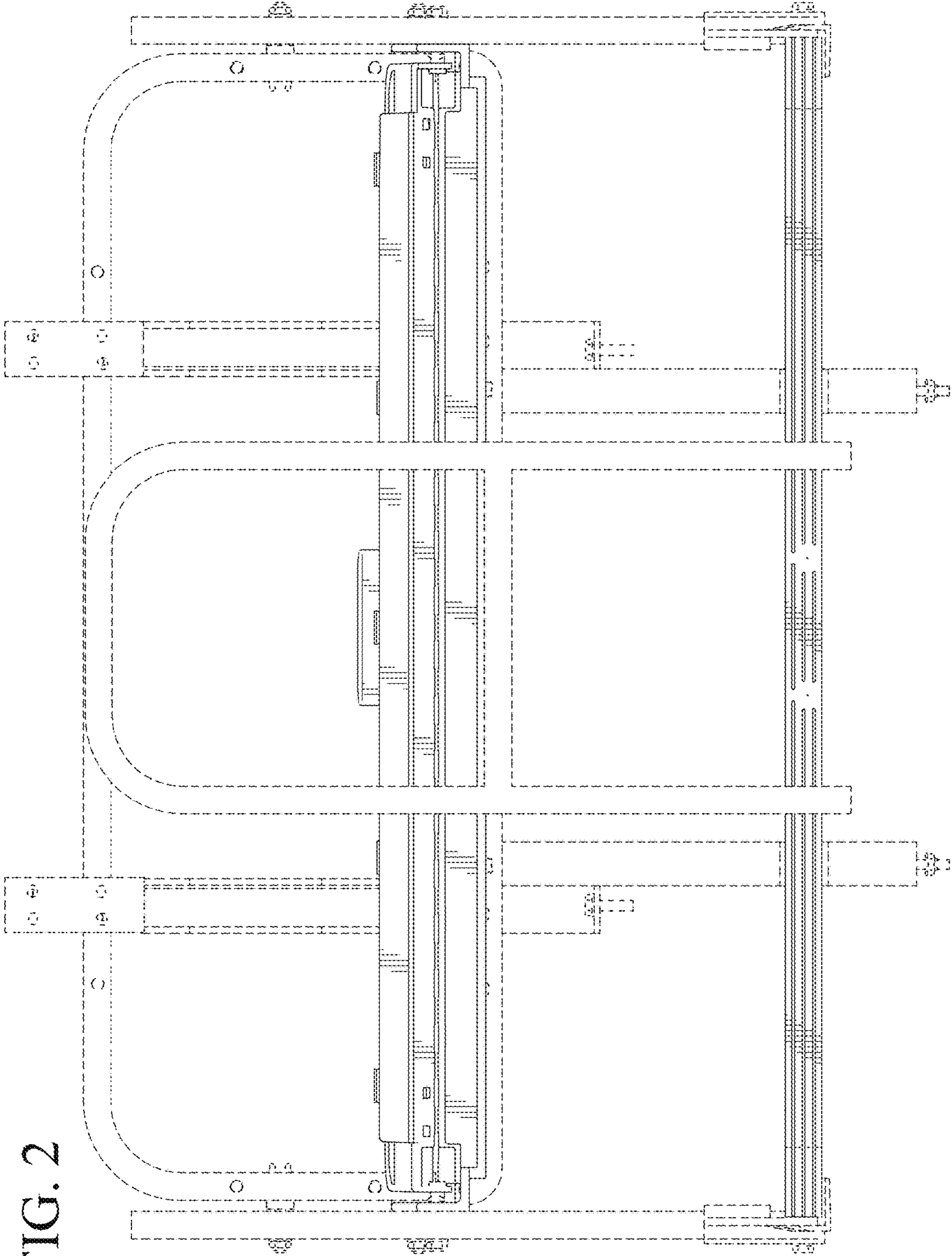
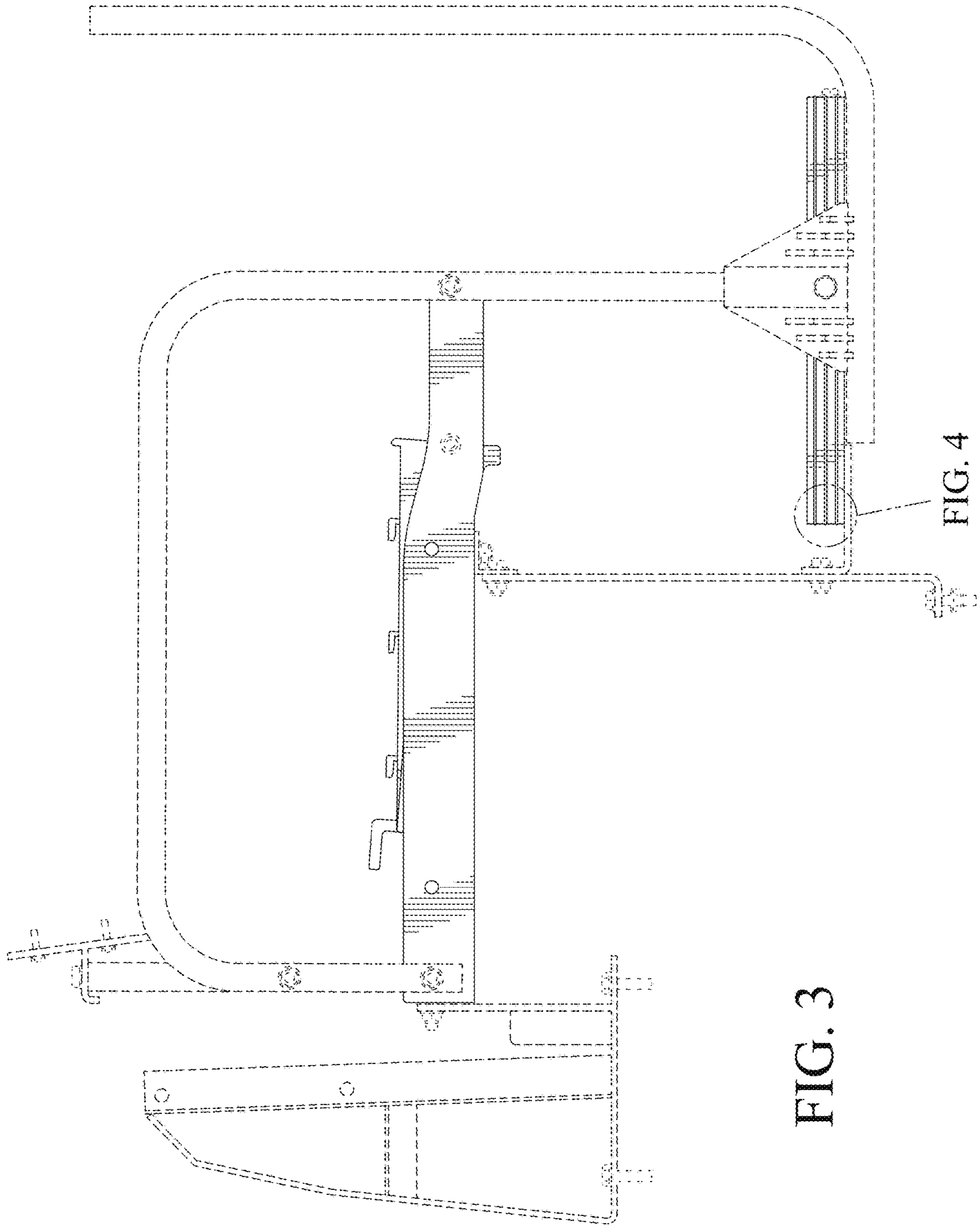

FIG. 2



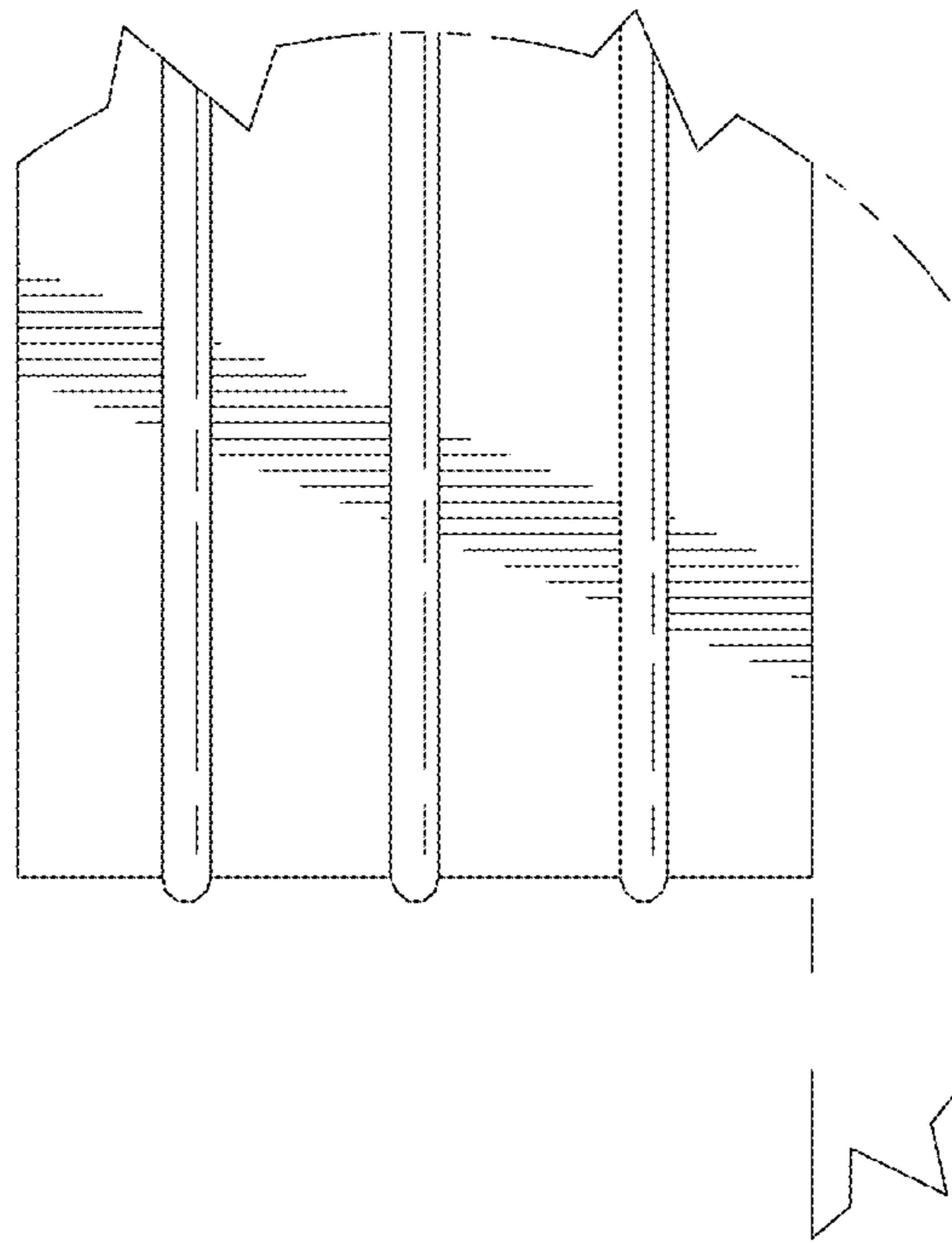

FIG. 4

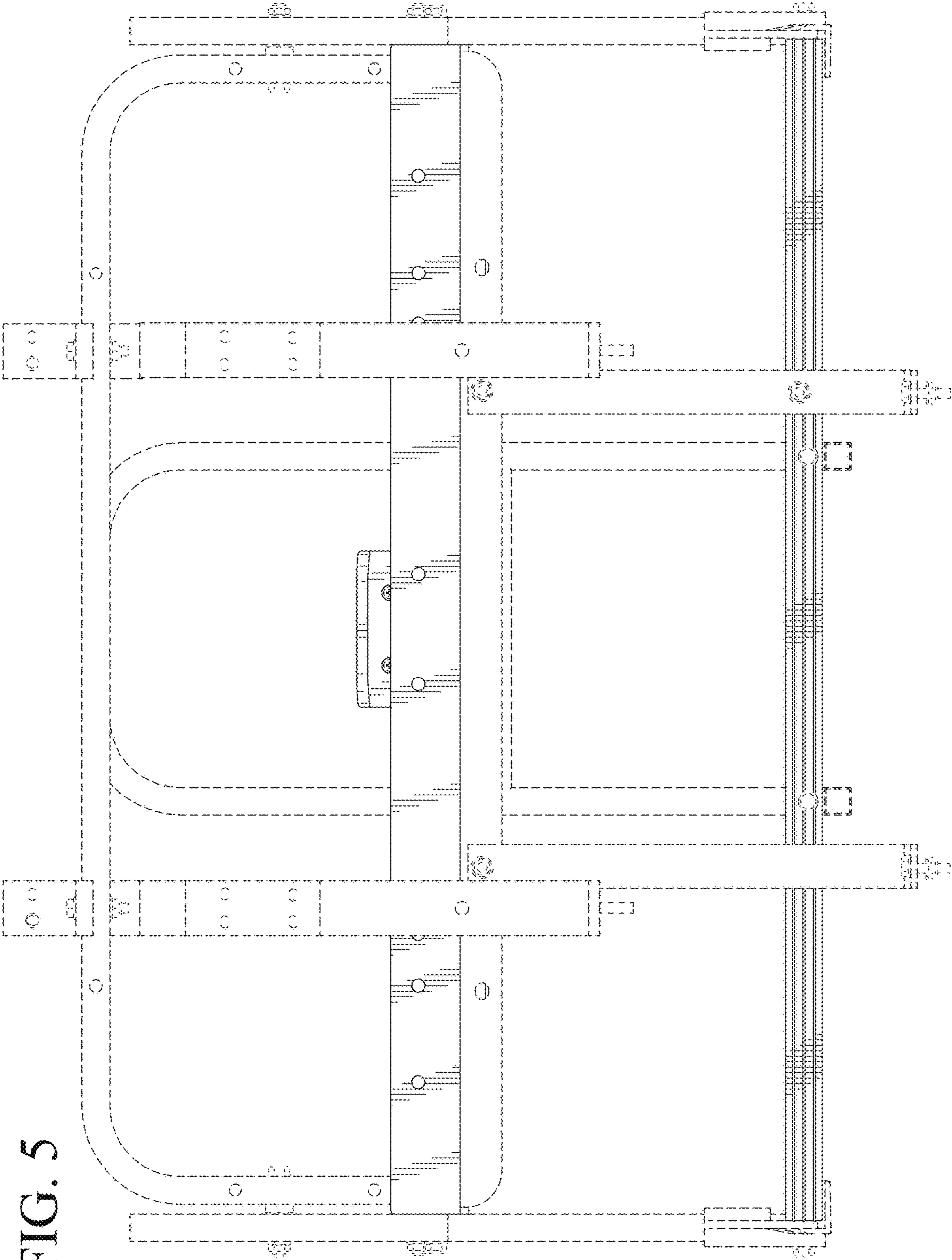

FIG. 5





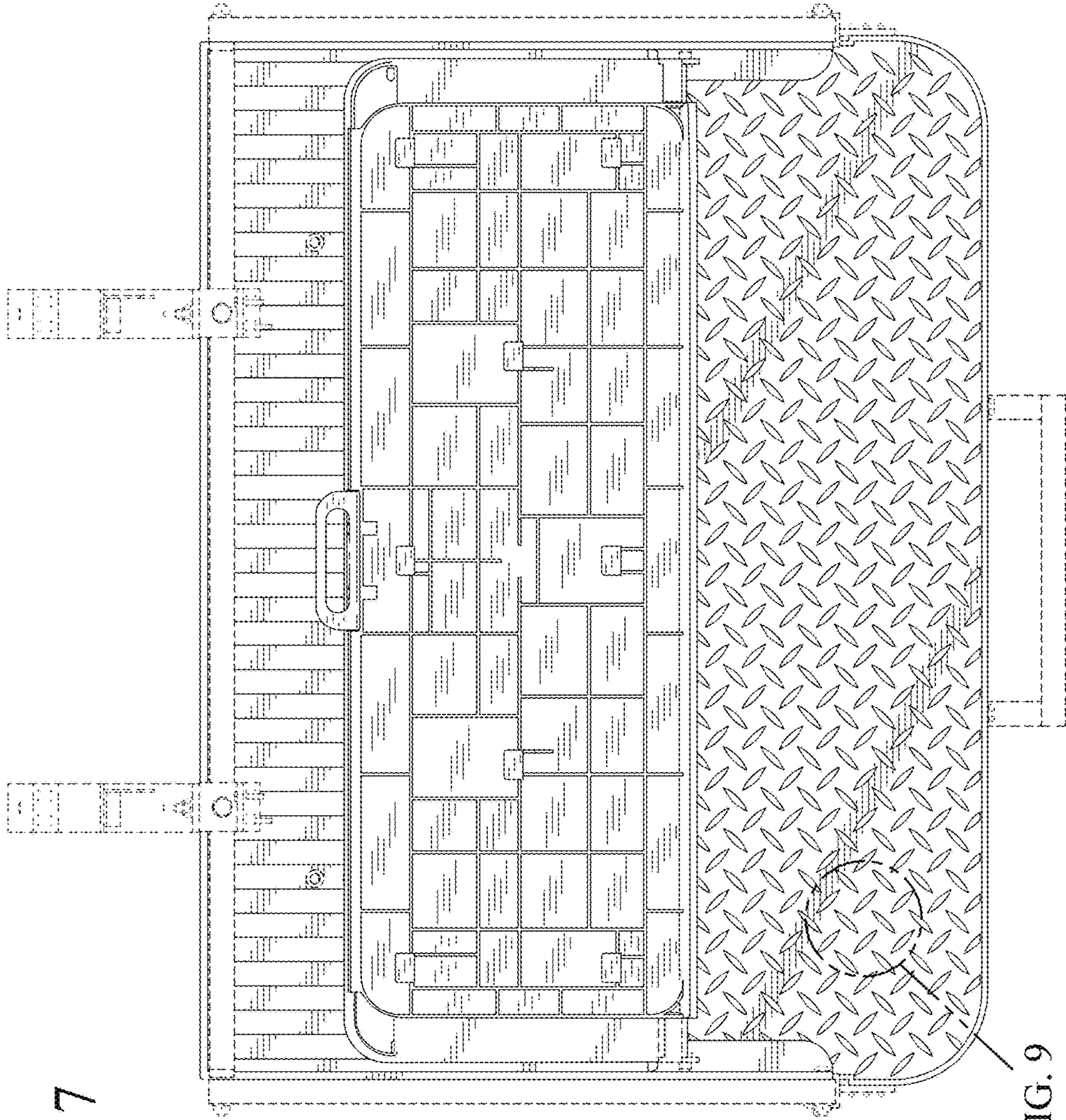

FIG. 7

FIG. 9

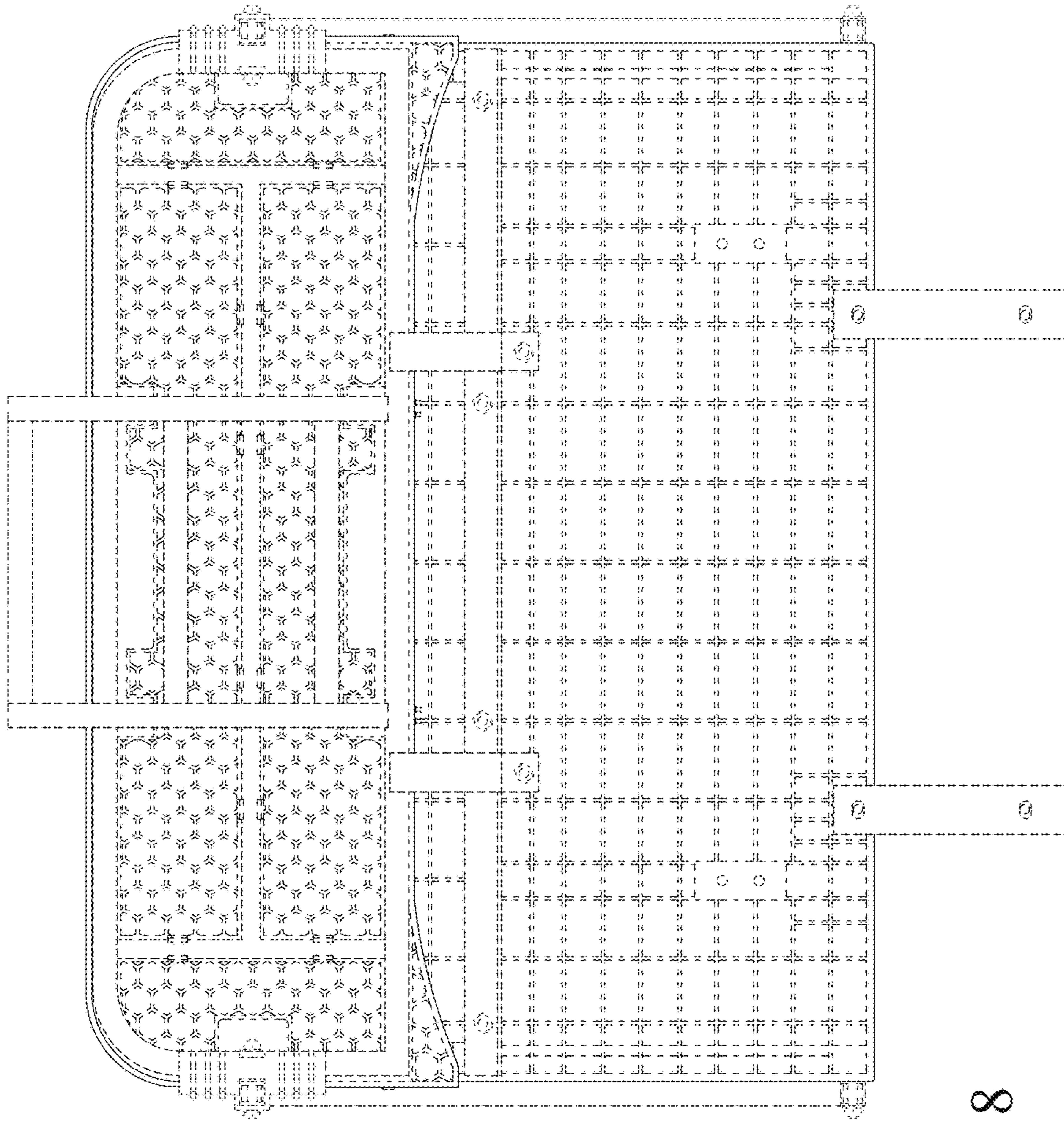

FIG. 8

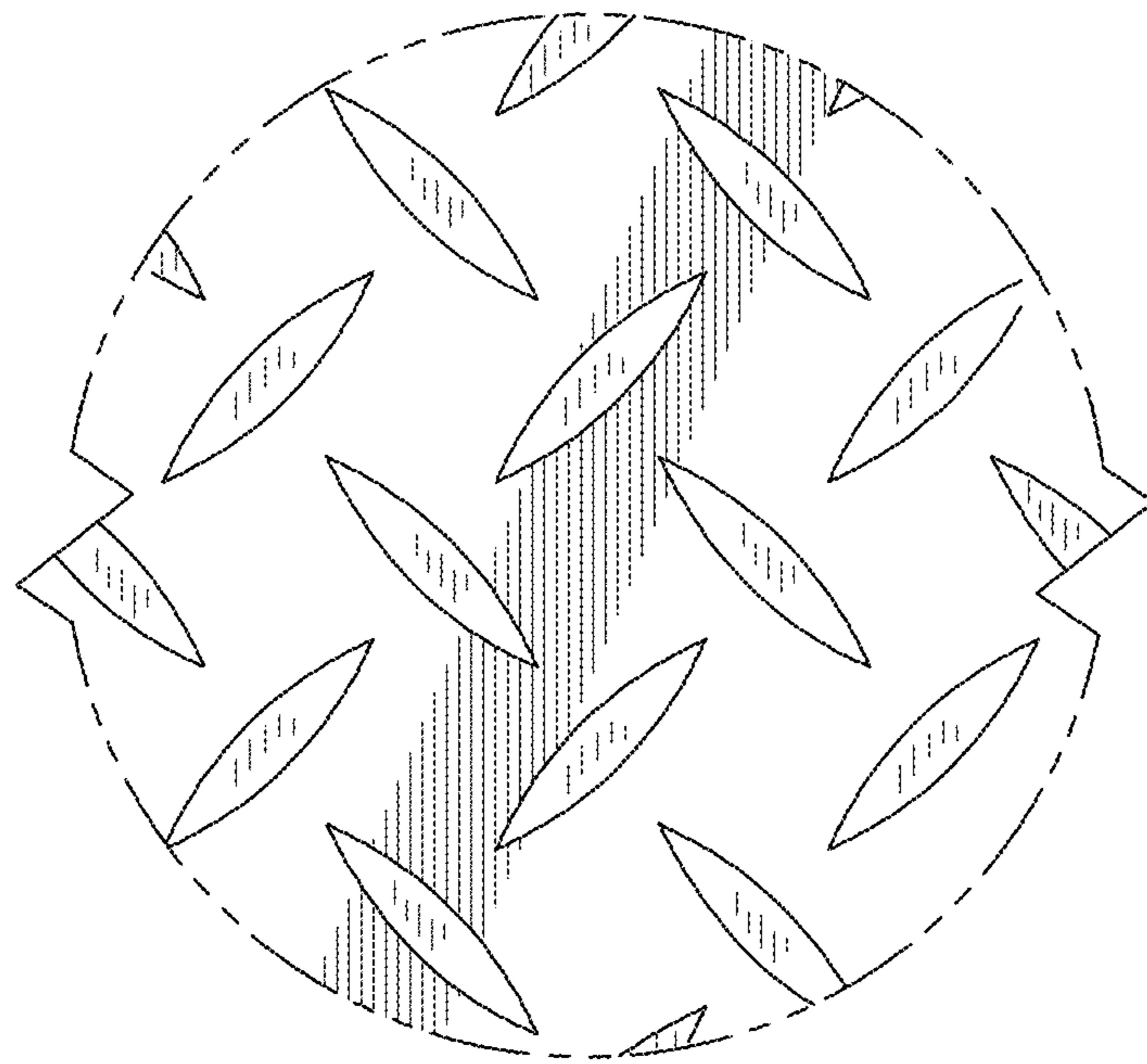

FIG. 9

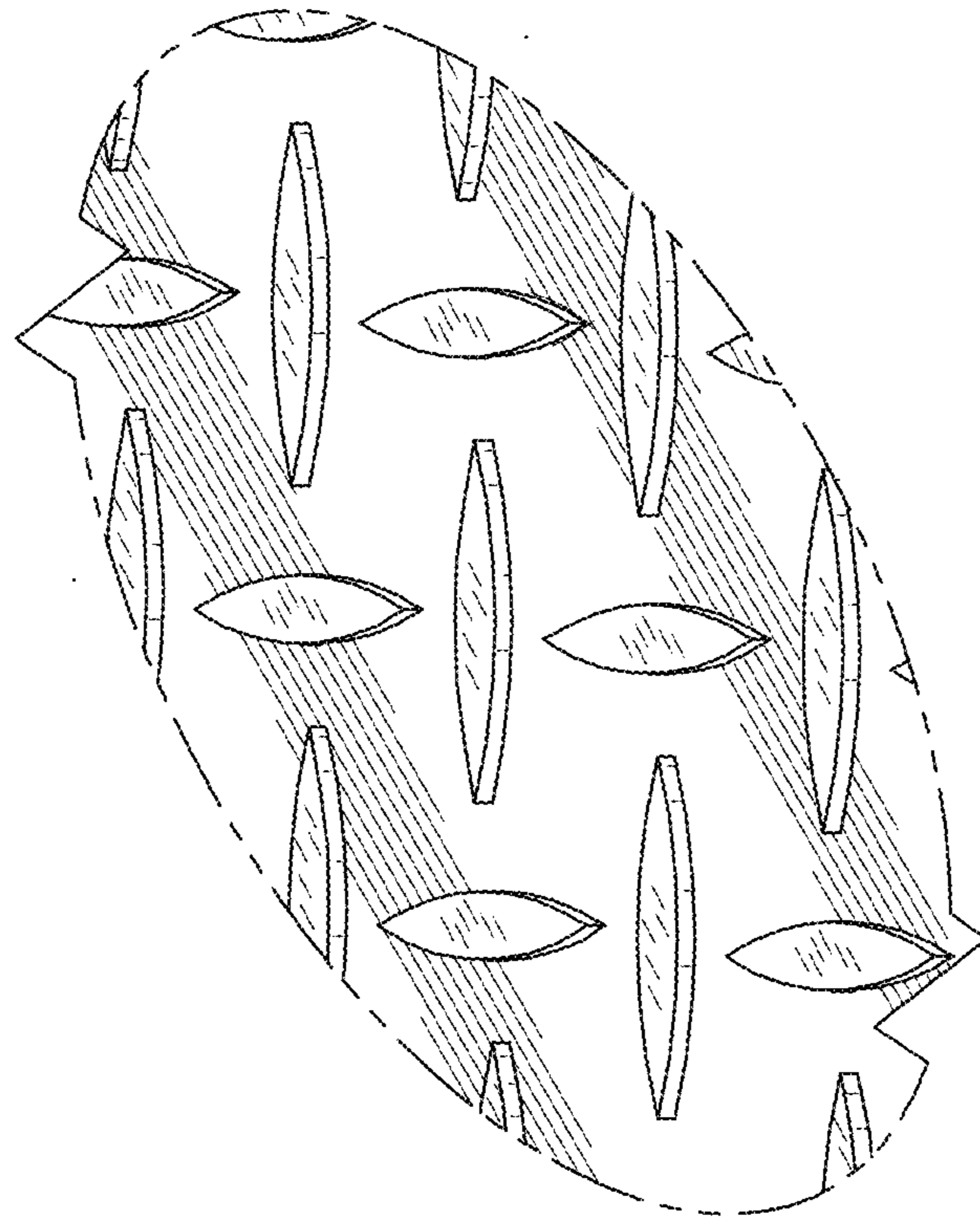

FIG. 10

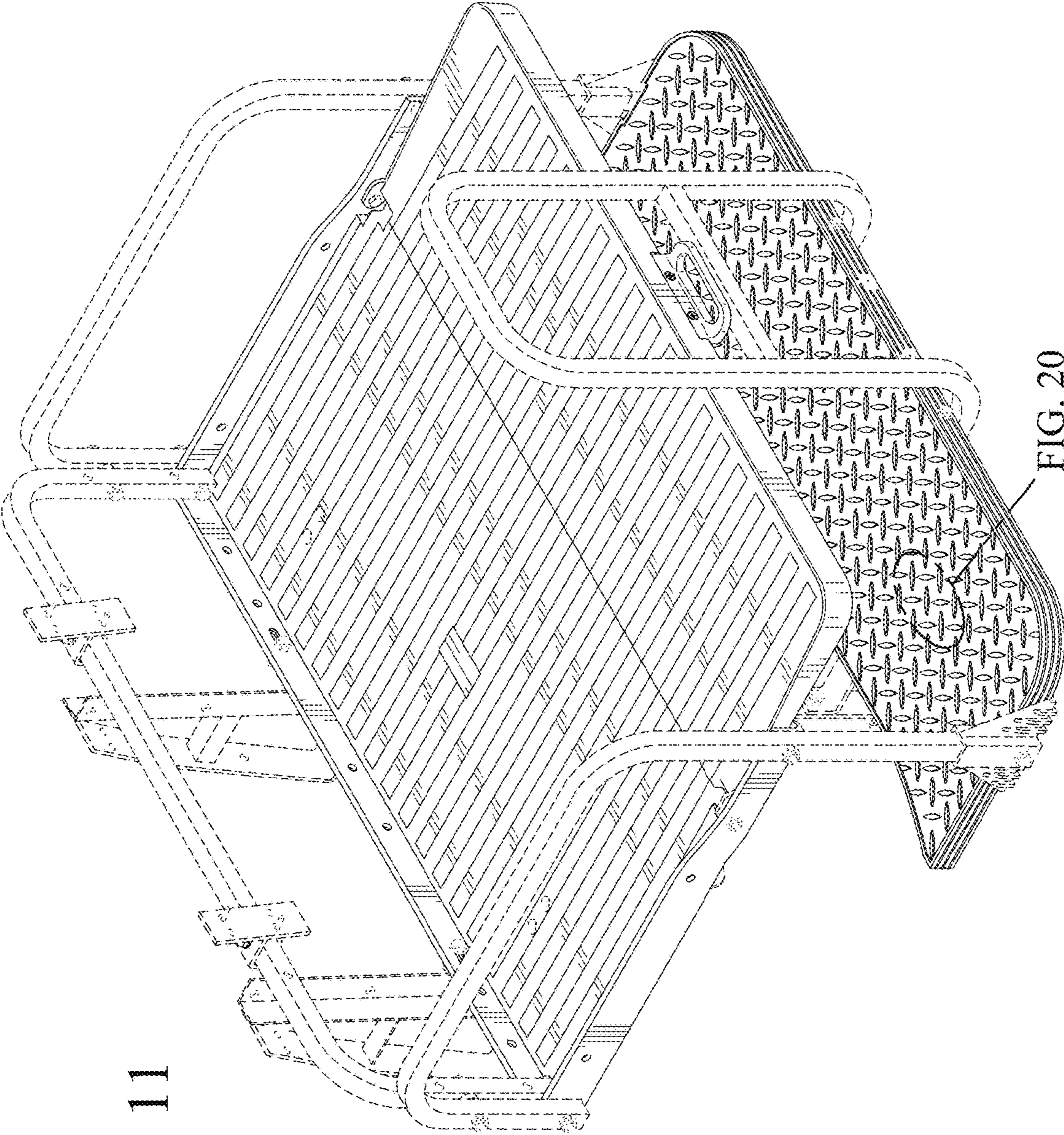

FIG. 11

FIG. 20

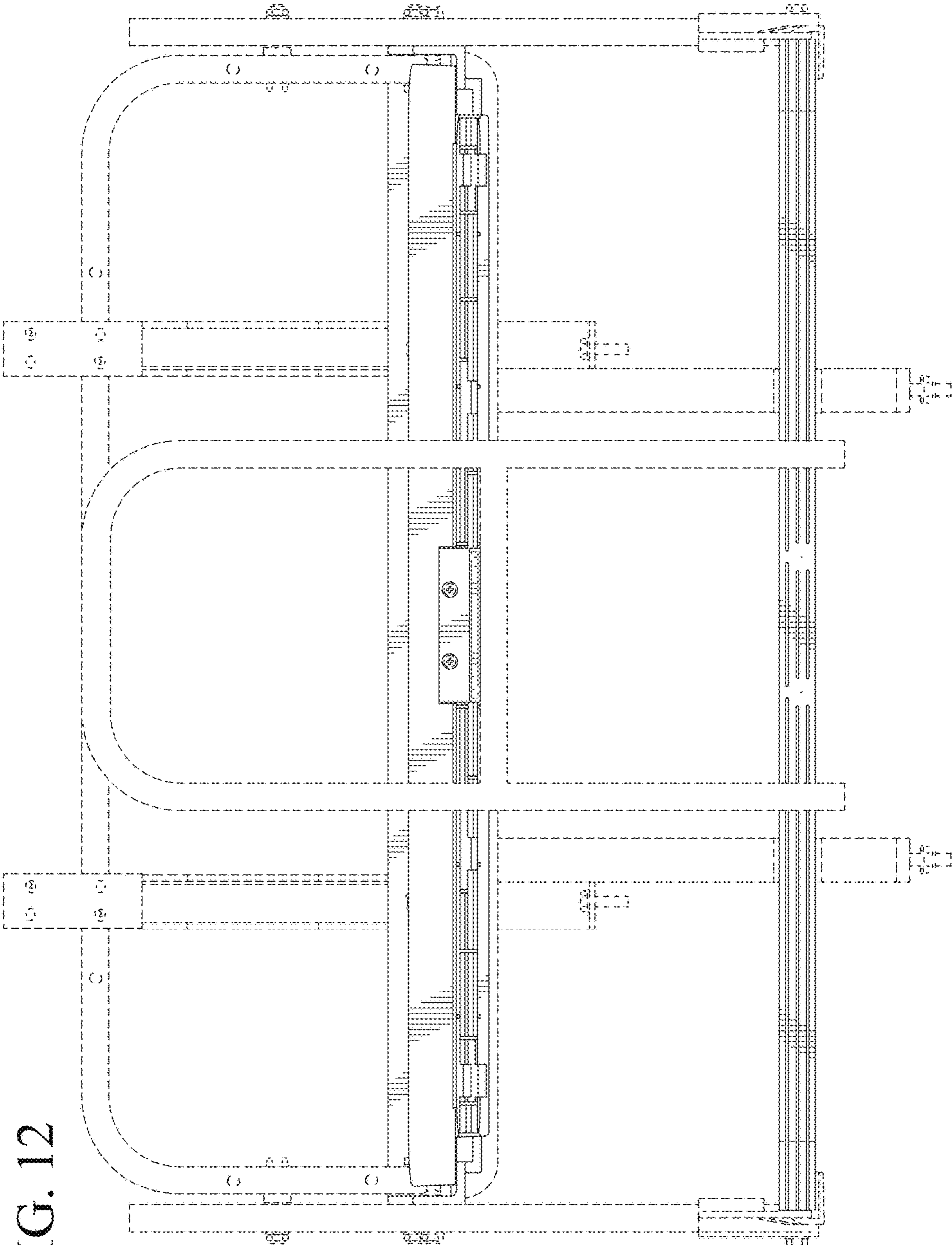

FIG. 12

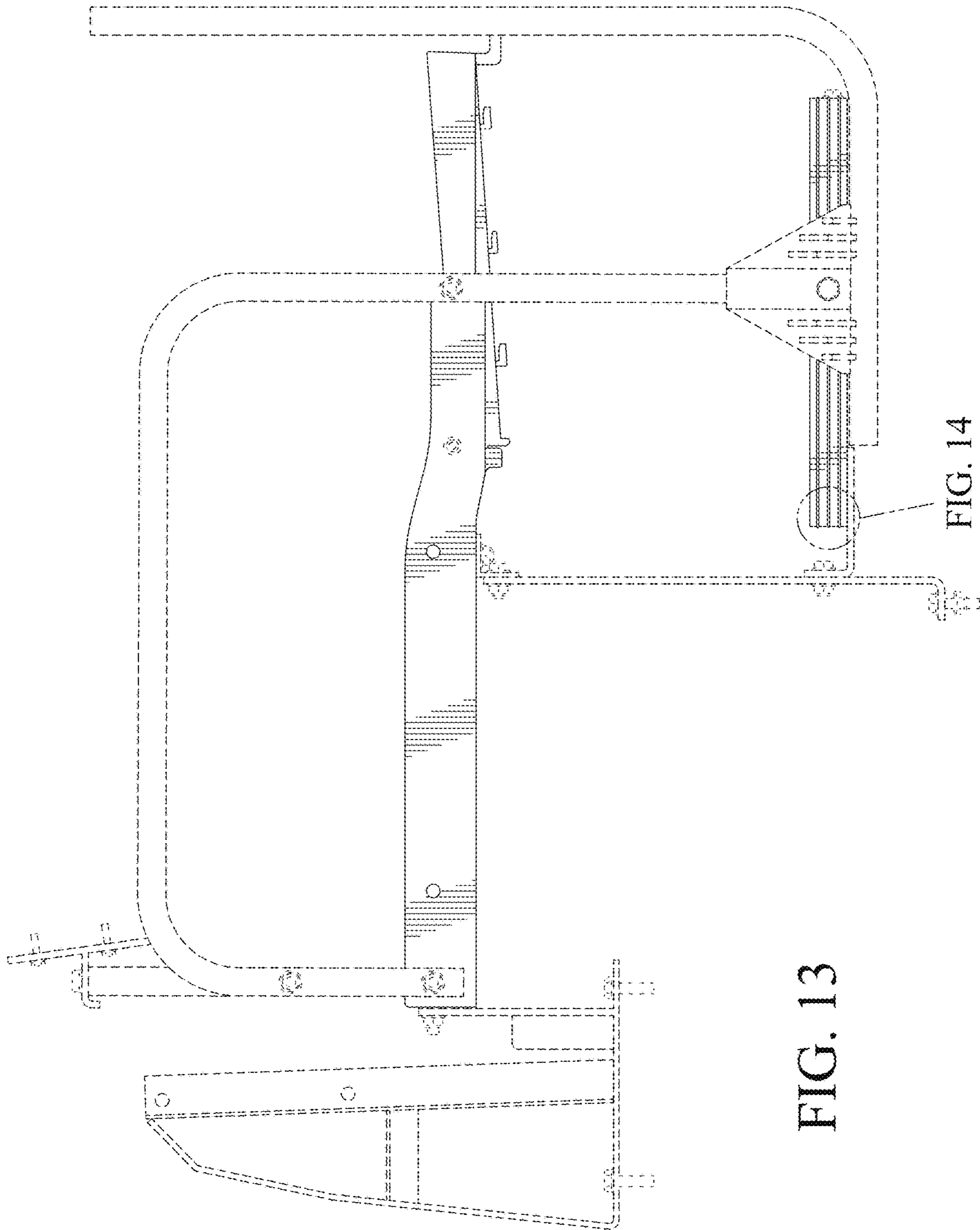

FIG. 13

FIG. 14

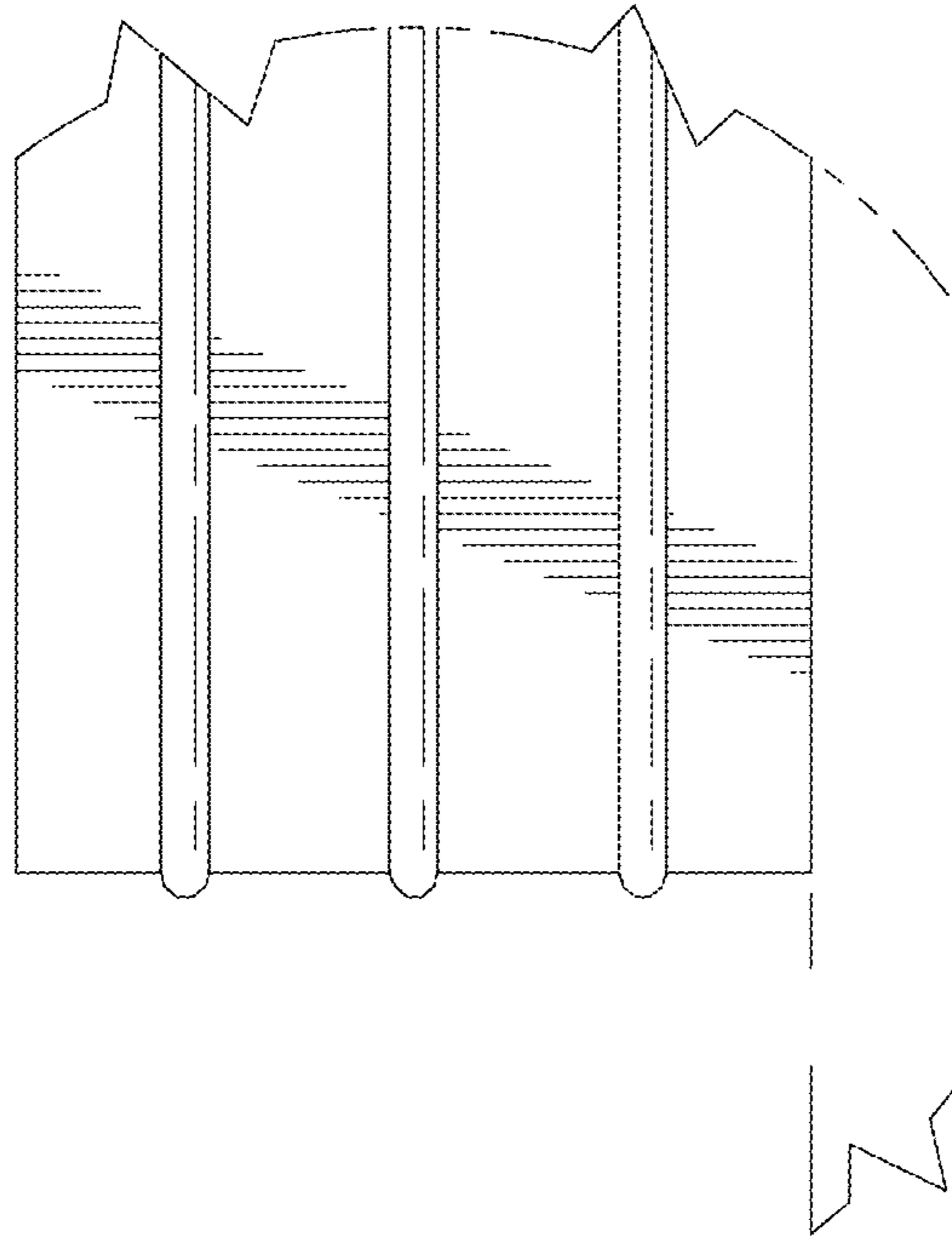

FIG. 14

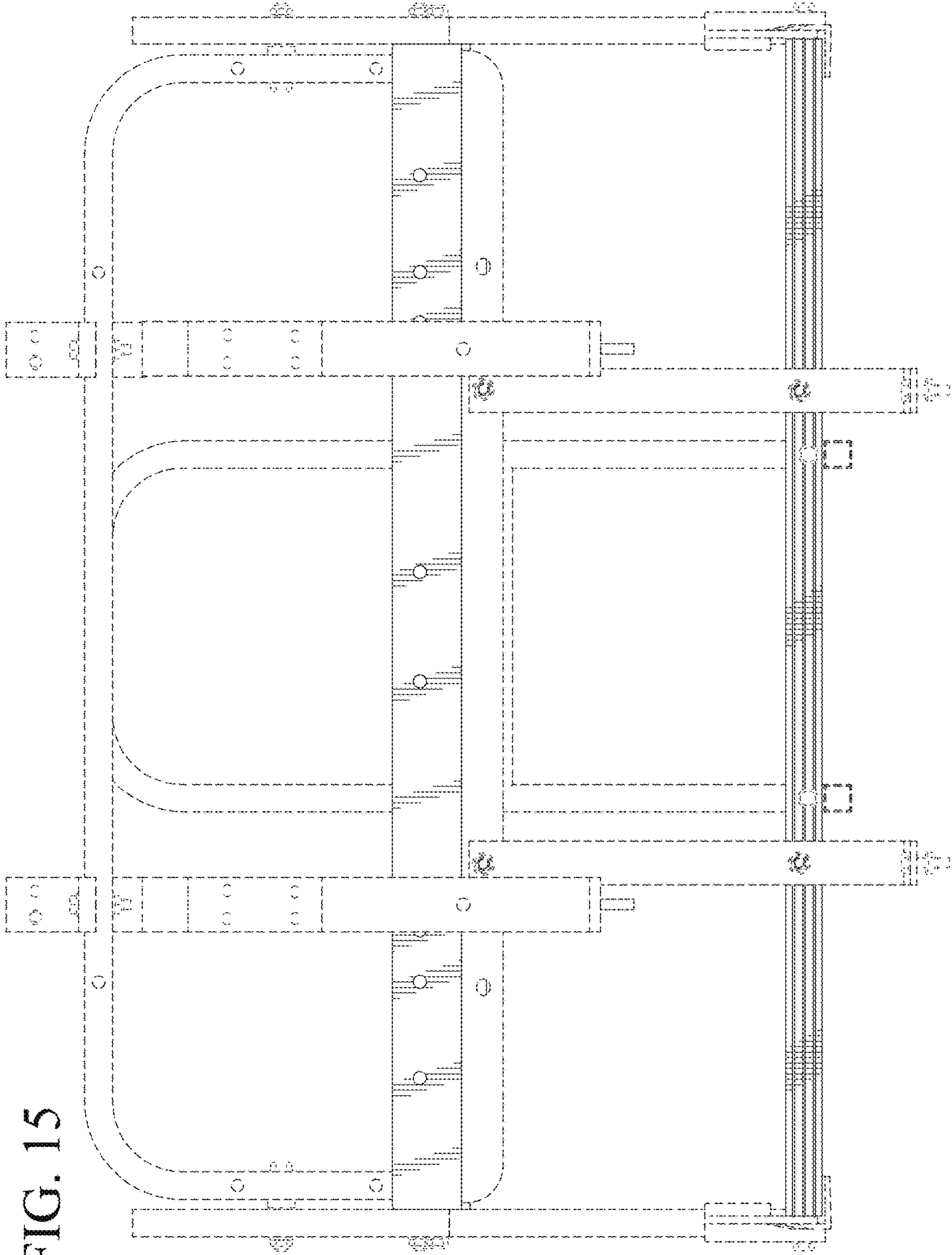

FIG. 15



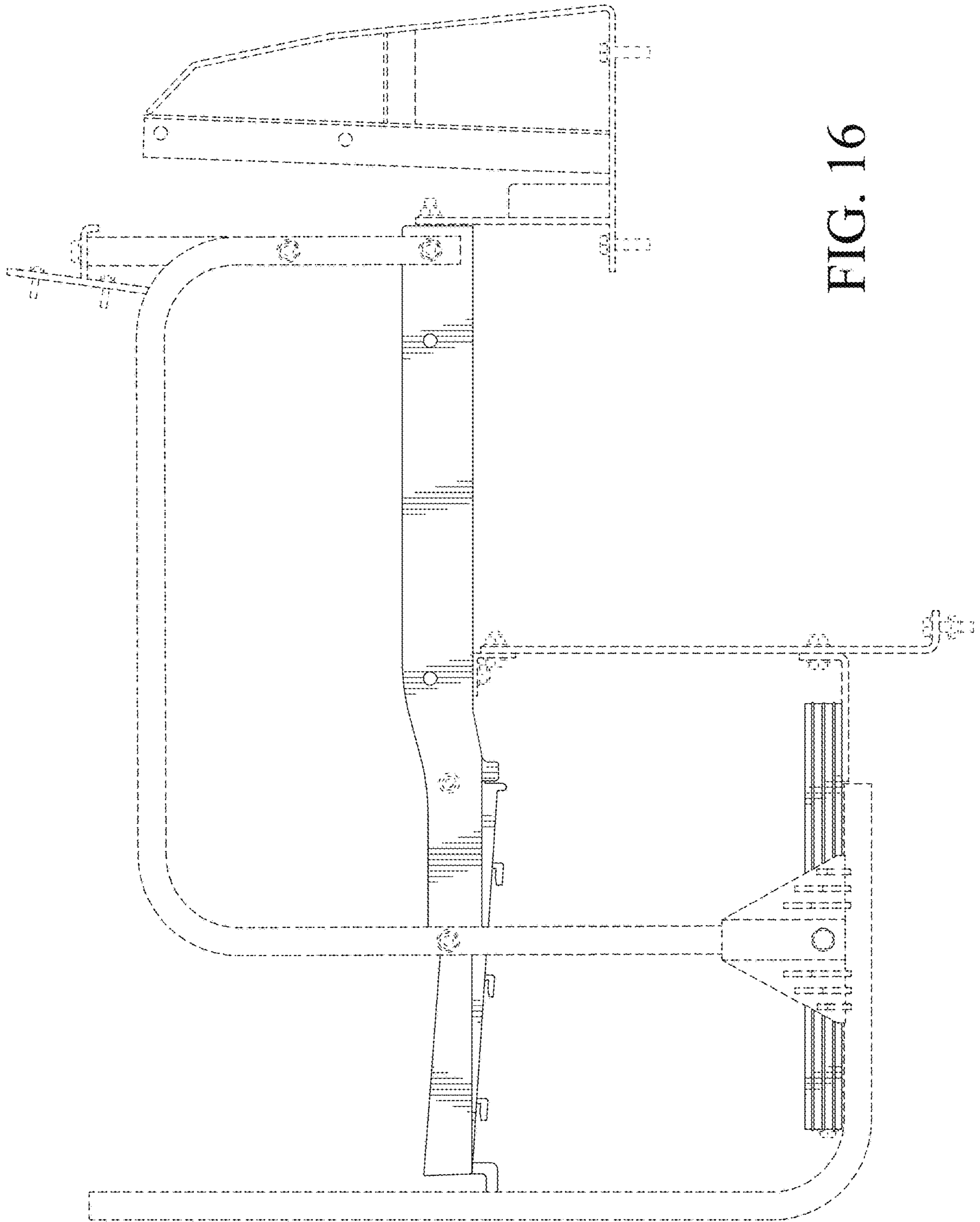

FIG. 16

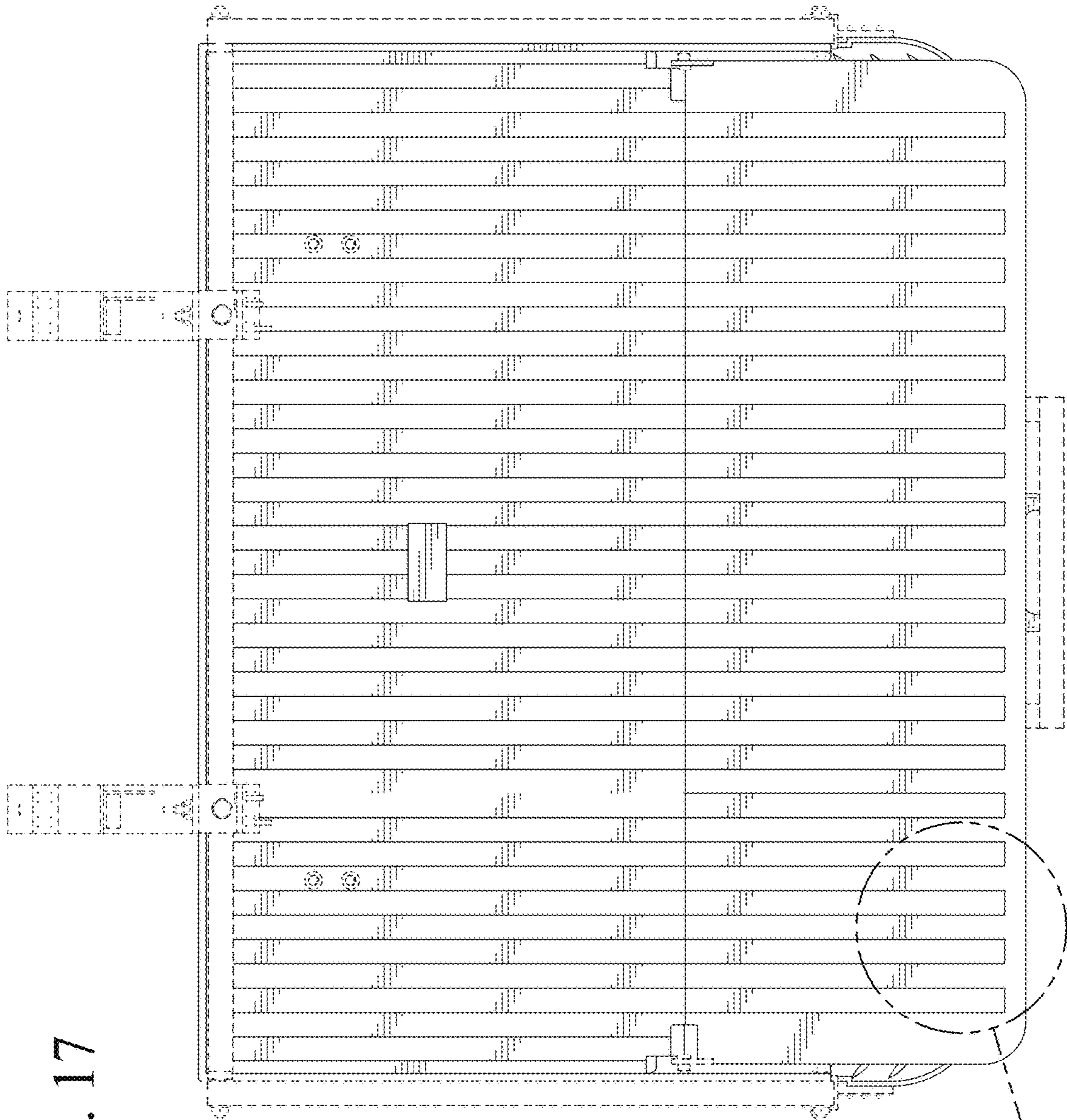

FIG. 17

FIG. 19

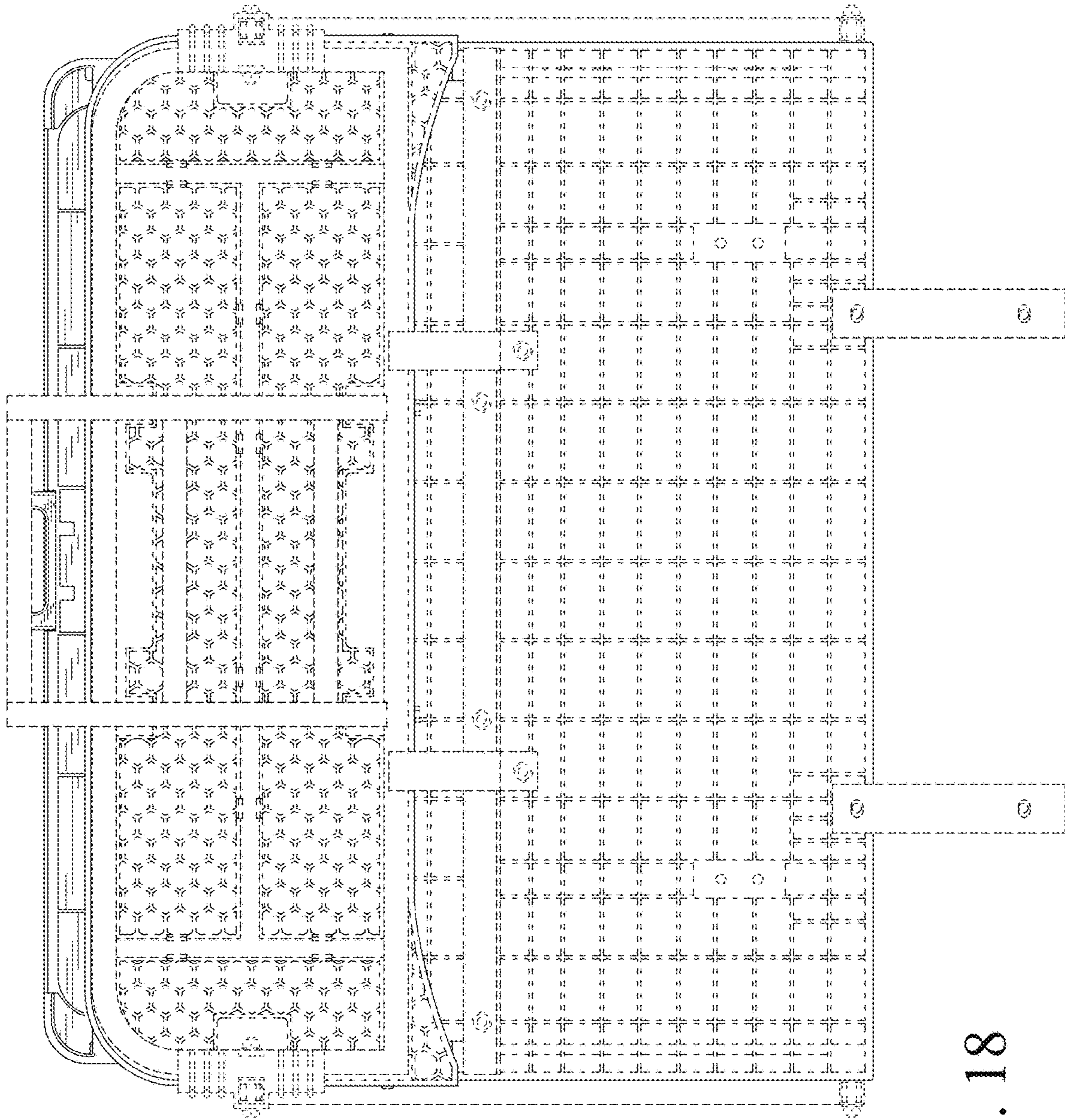

FIG. 18

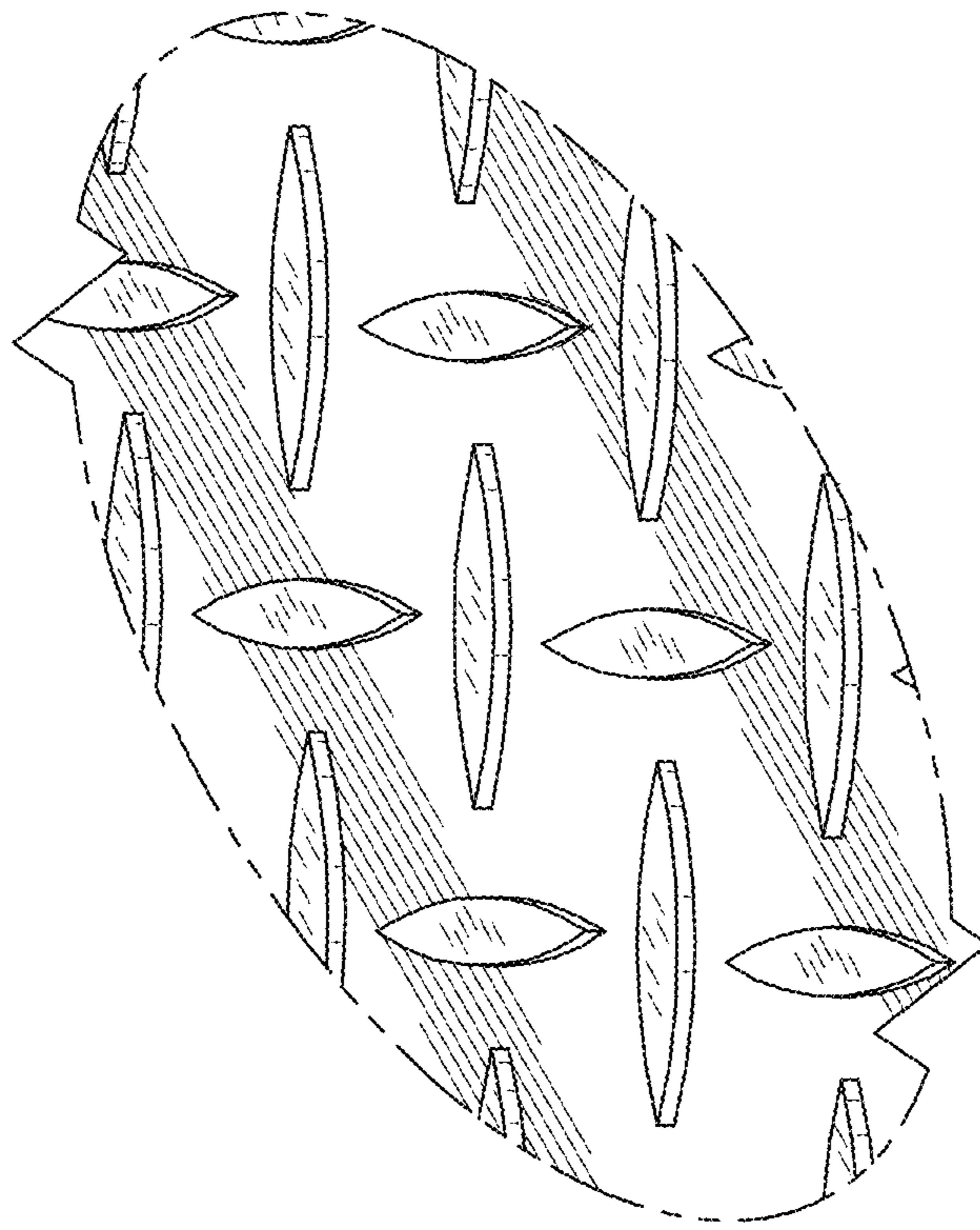

FIG. 20

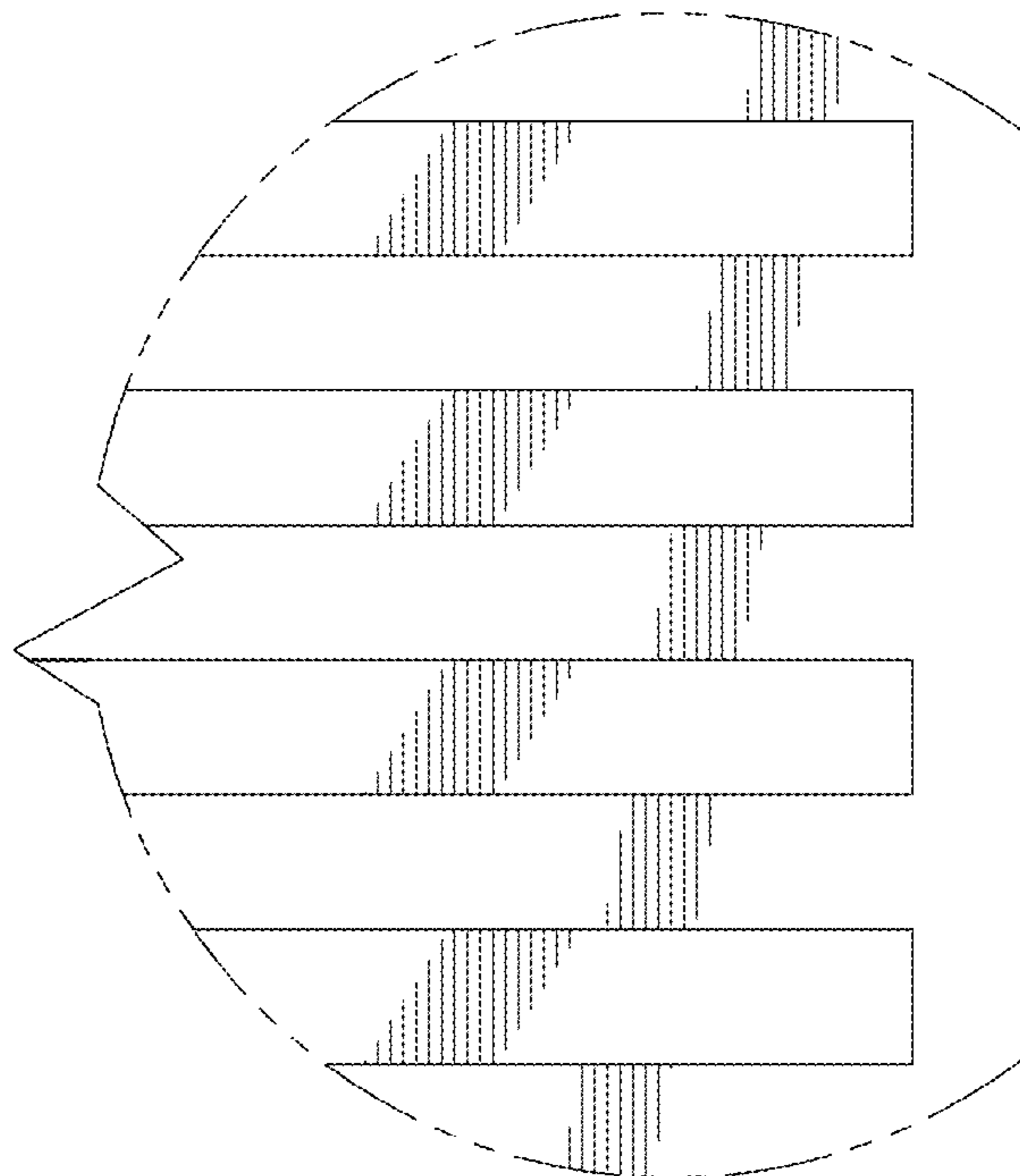

FIG. 19

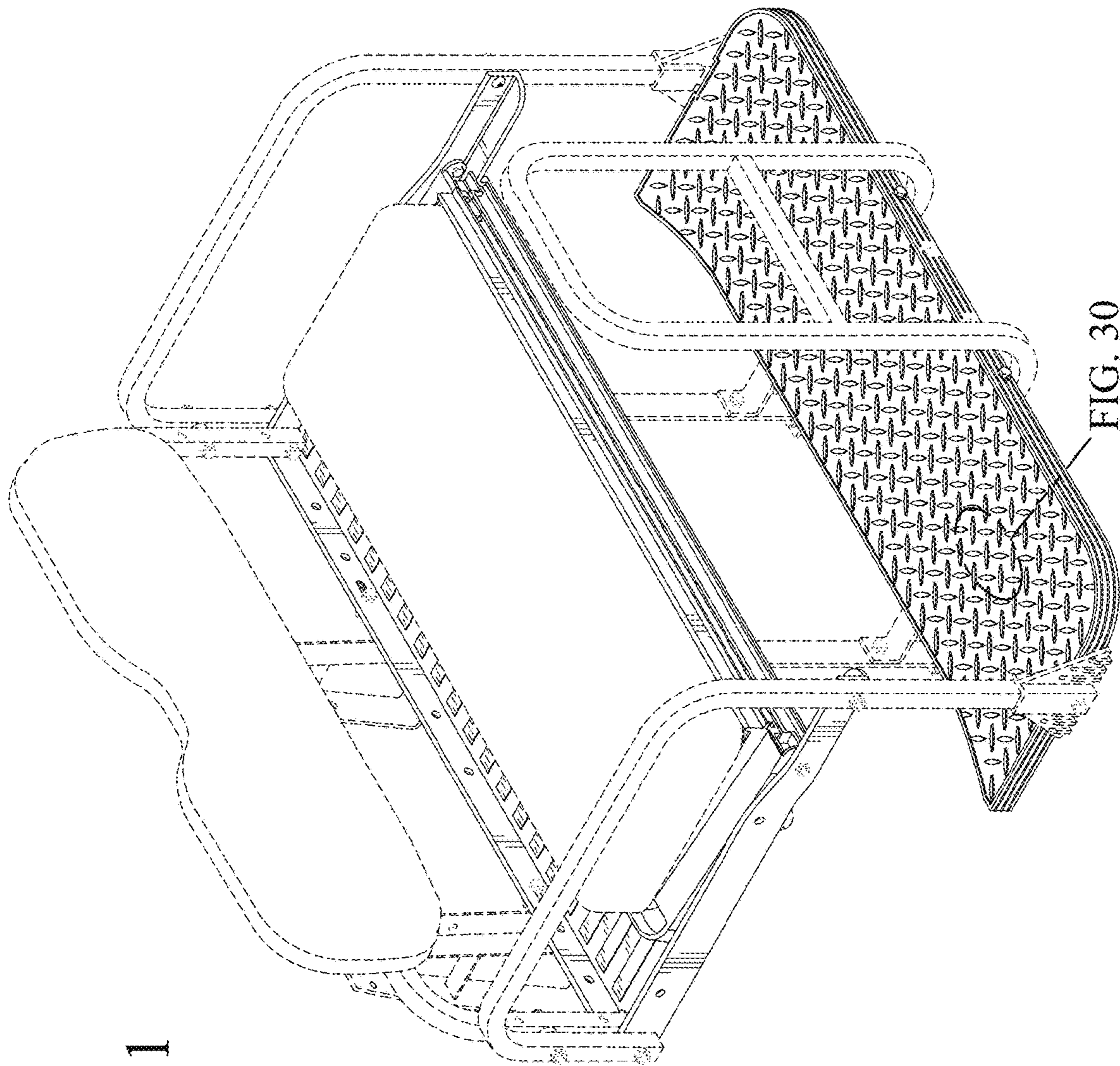

FIG. 21

FIG. 30

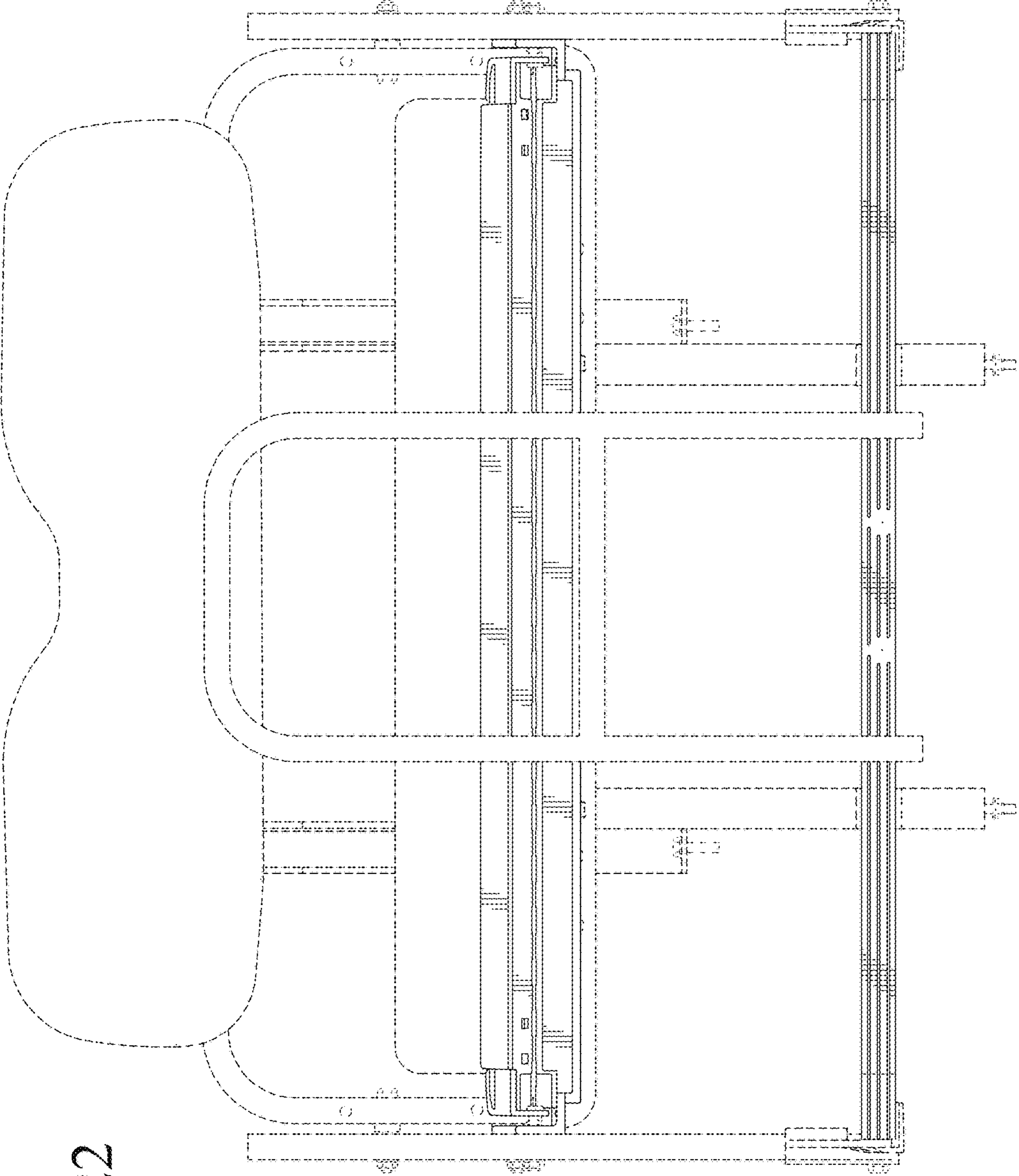
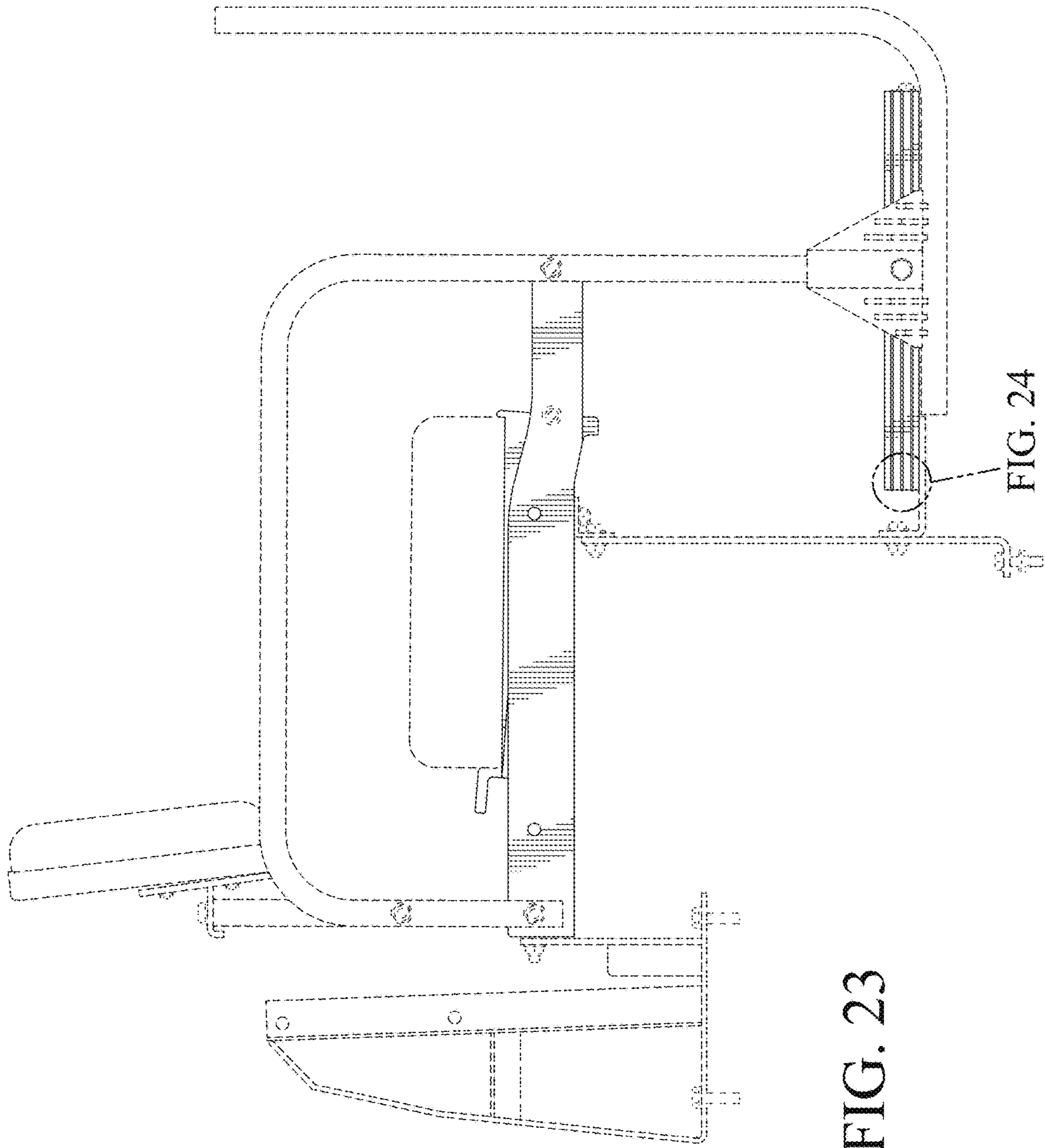

FIG. 22



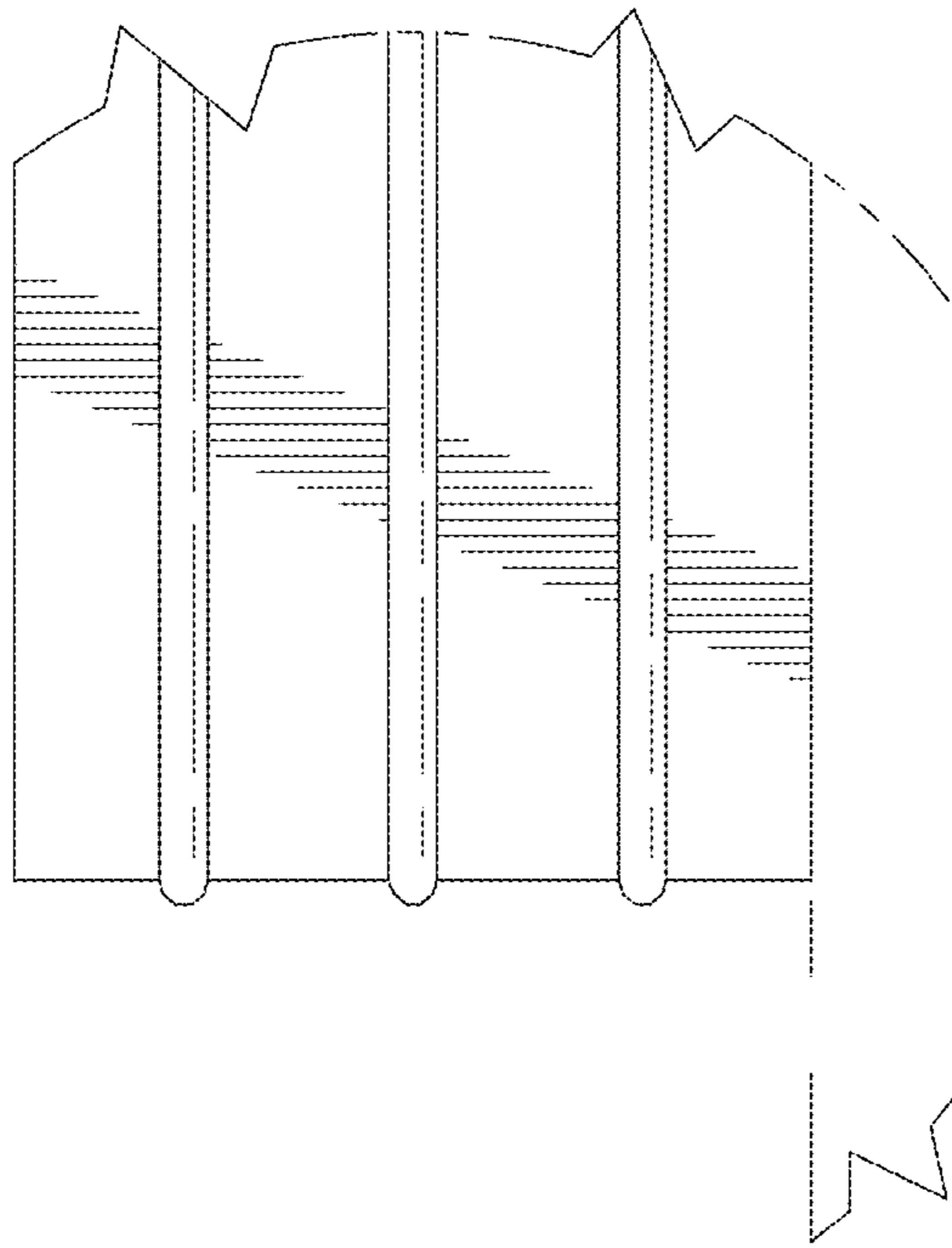

FIG. 24



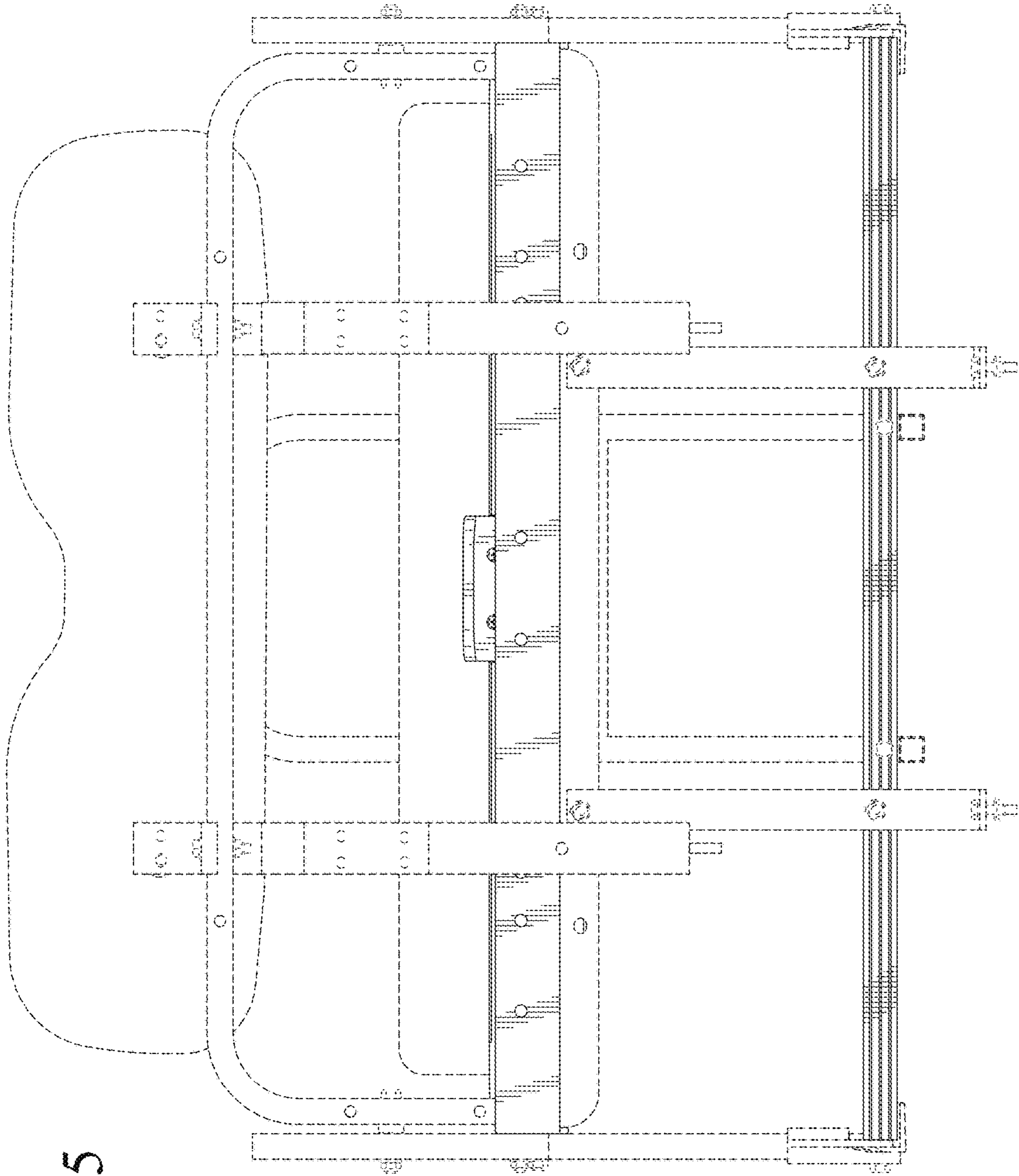

FIG. 25

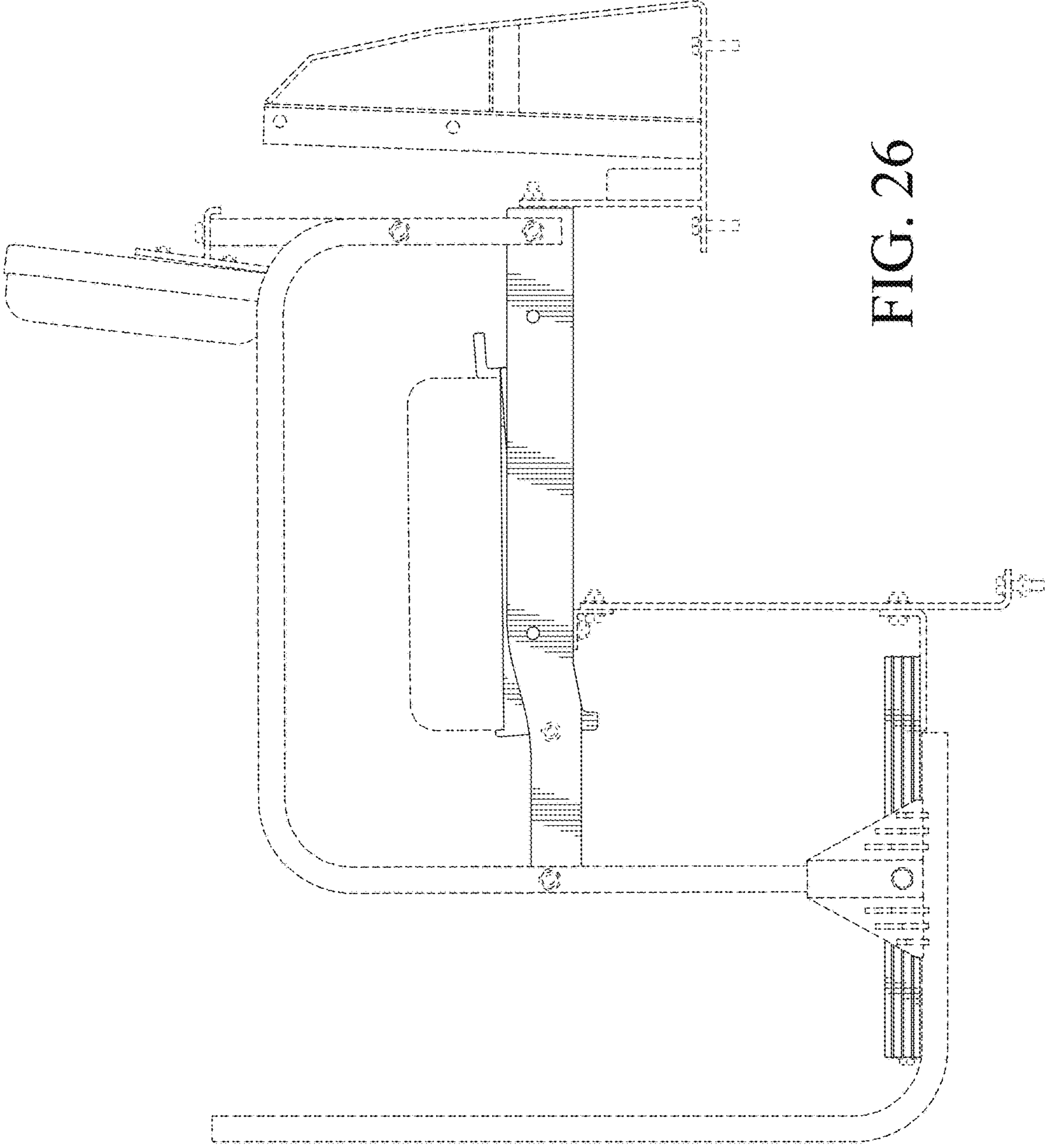

FIG. 26

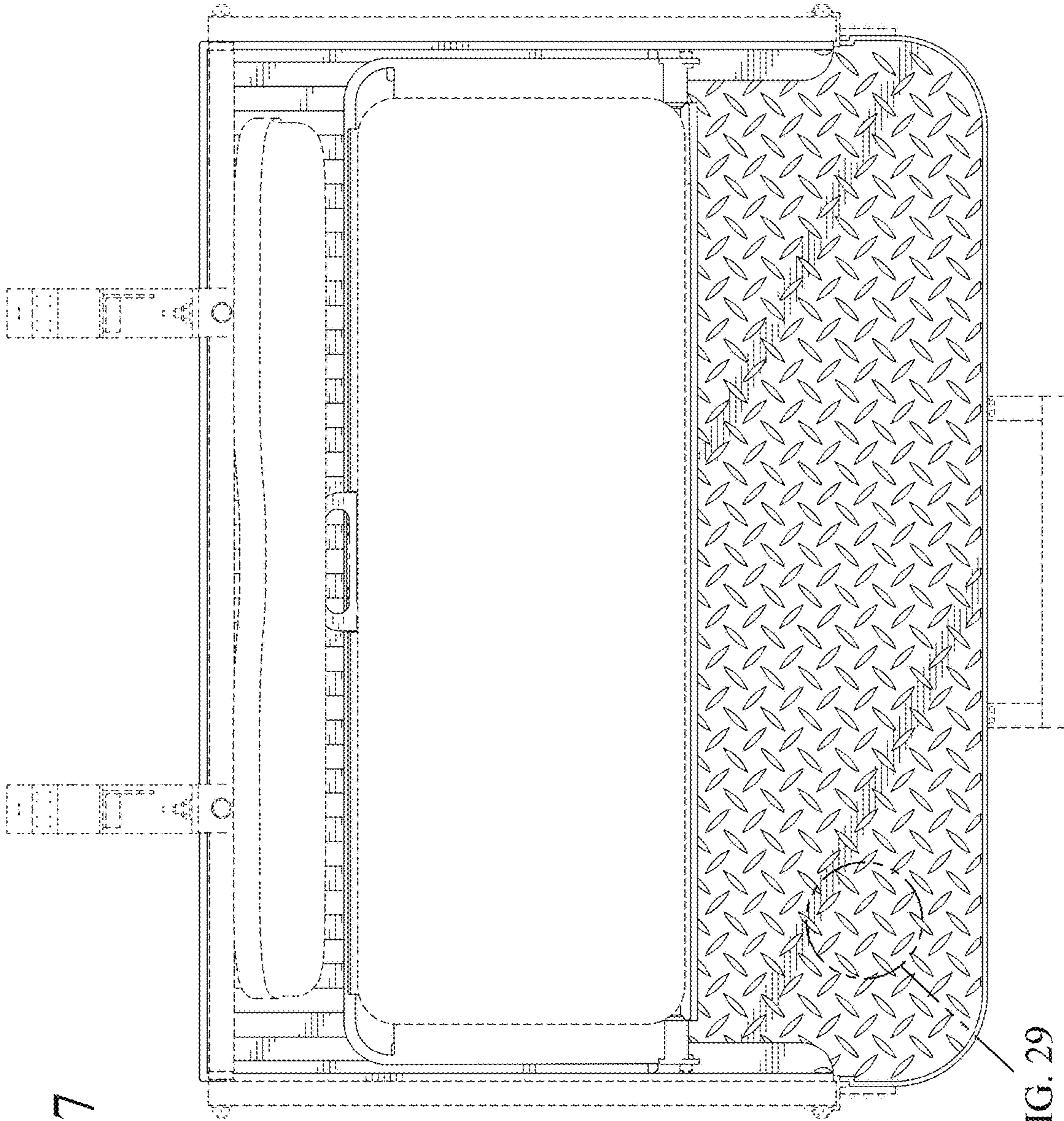

FIG. 27

FIG. 29

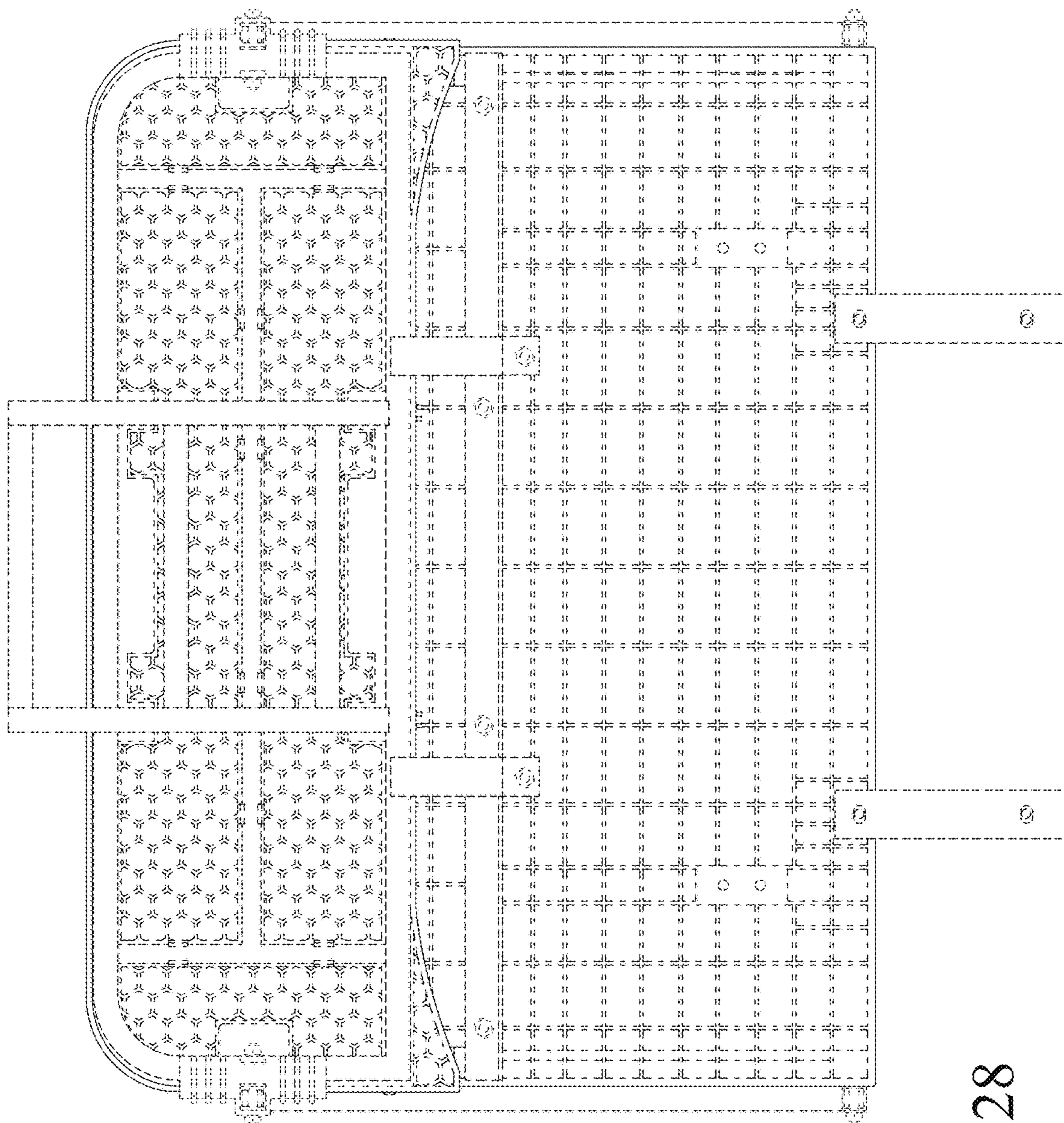

FIG. 28

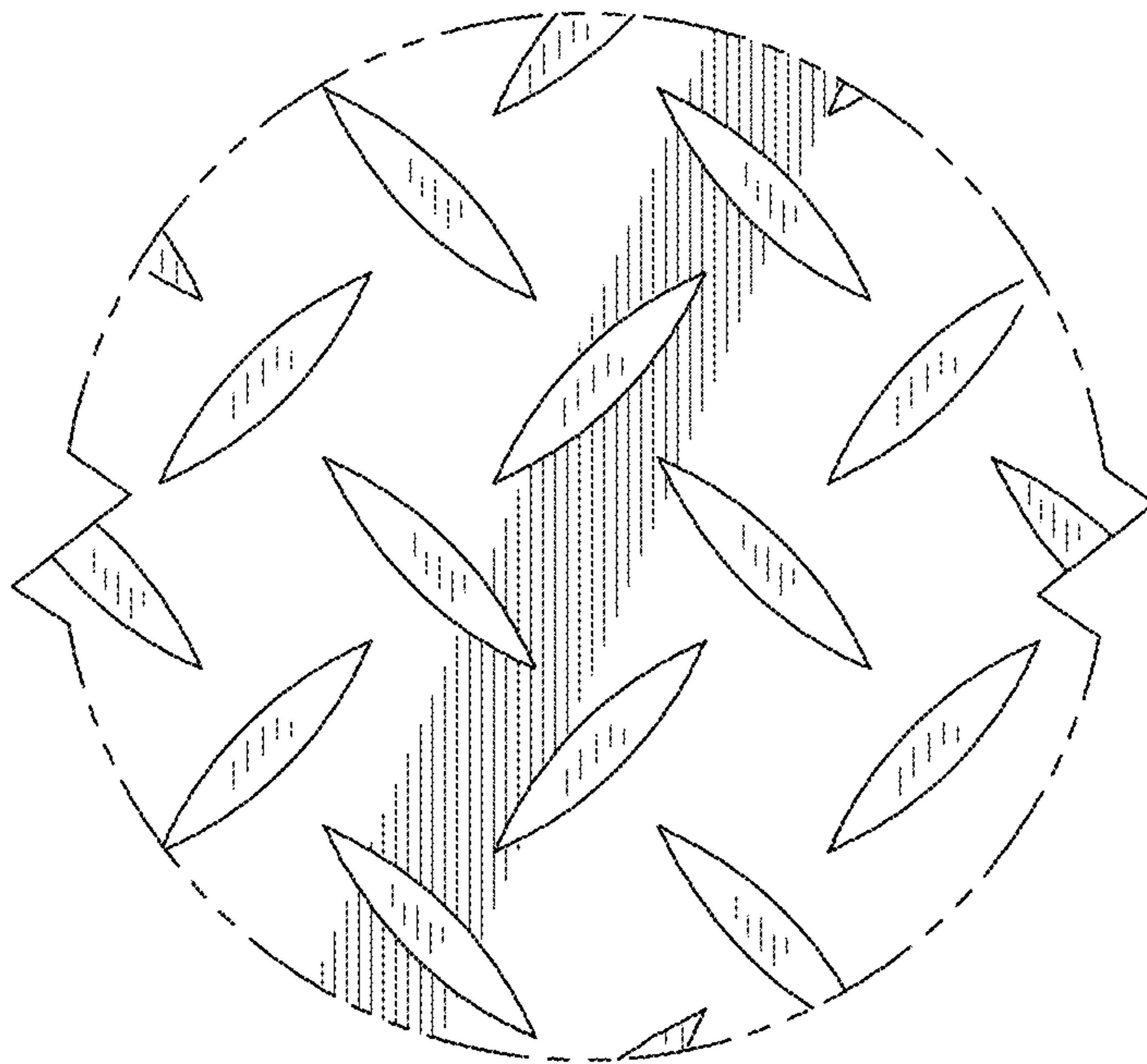

FIG. 29

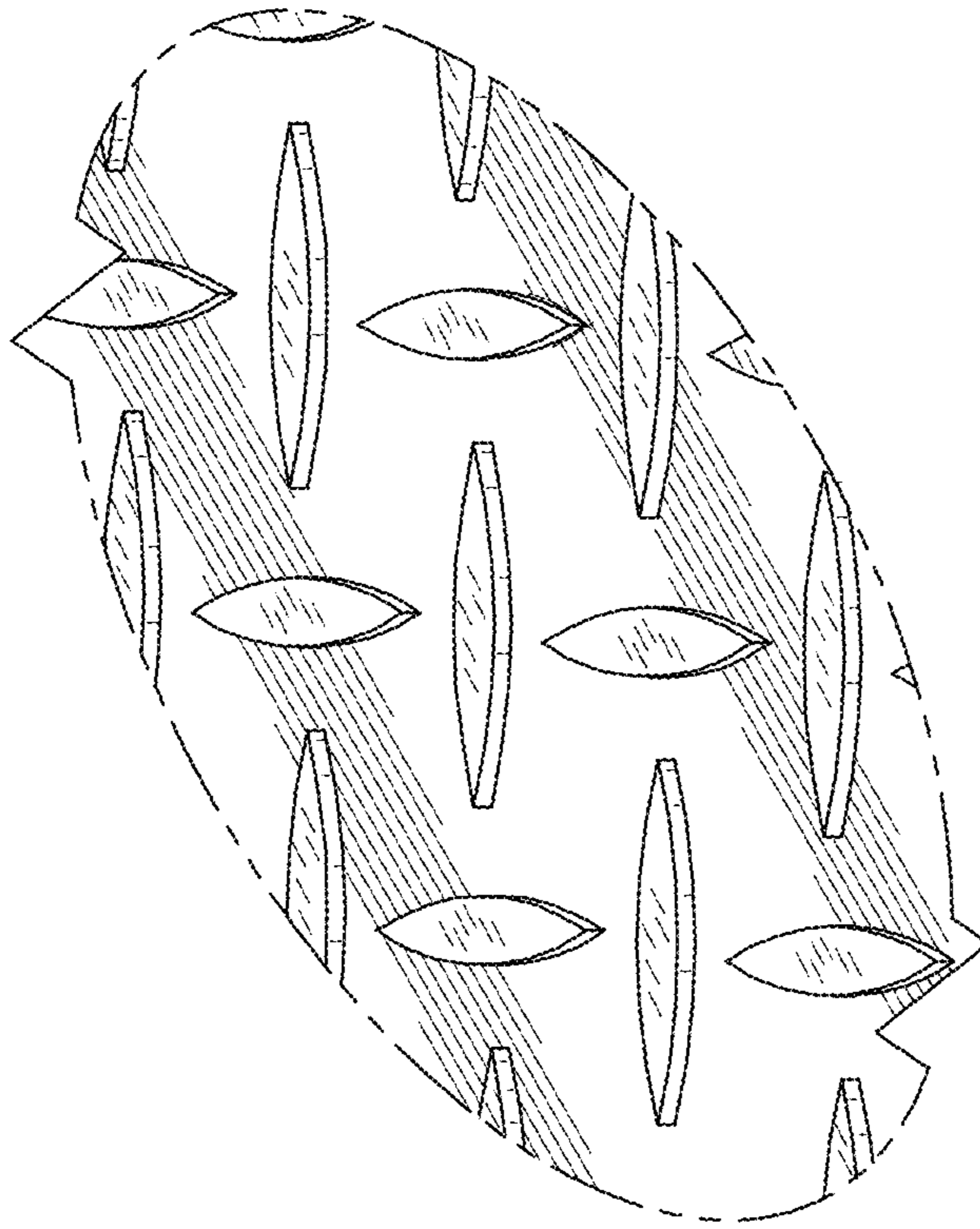

FIG. 30

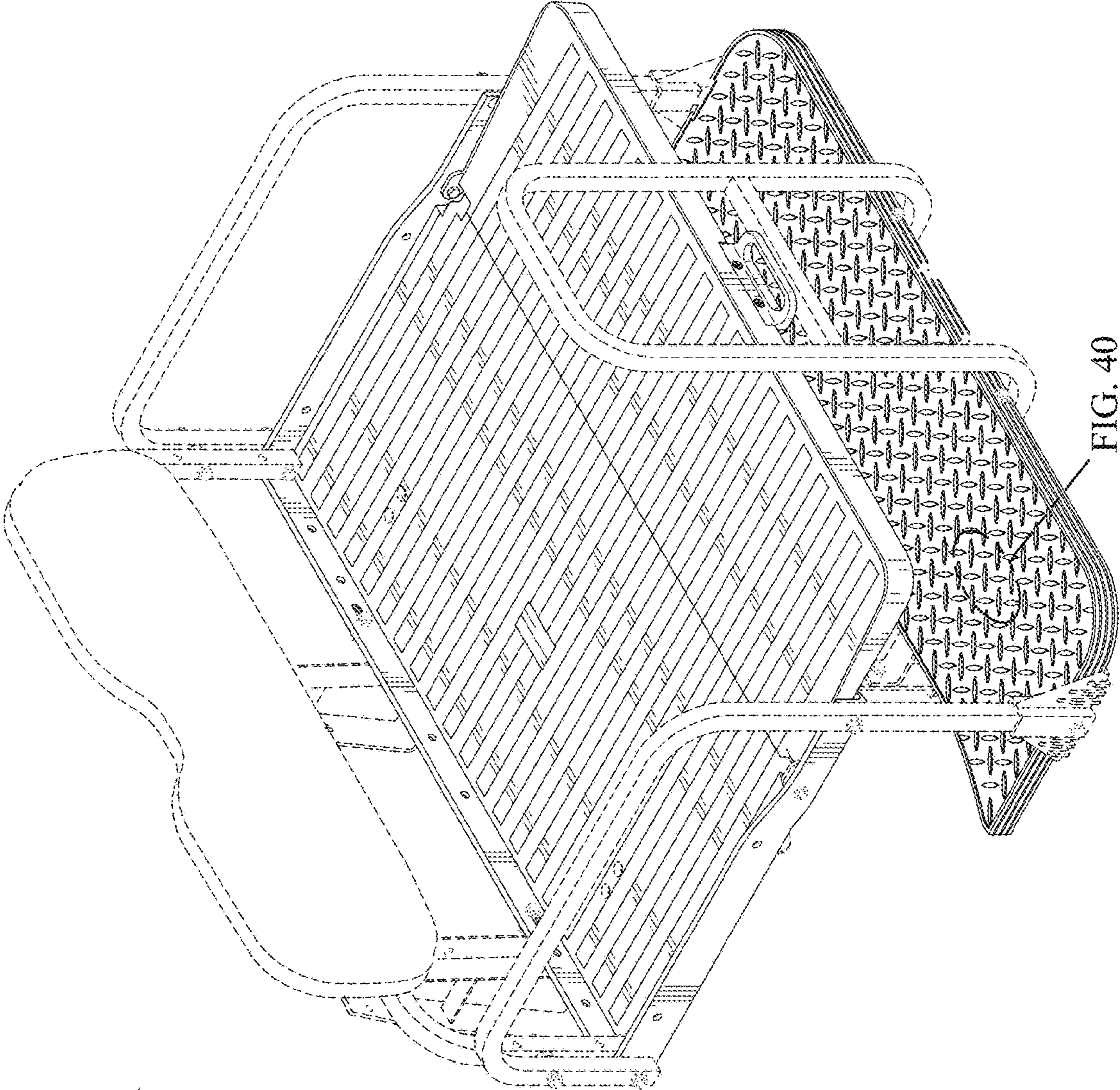

FIG. 31

FIG. 40

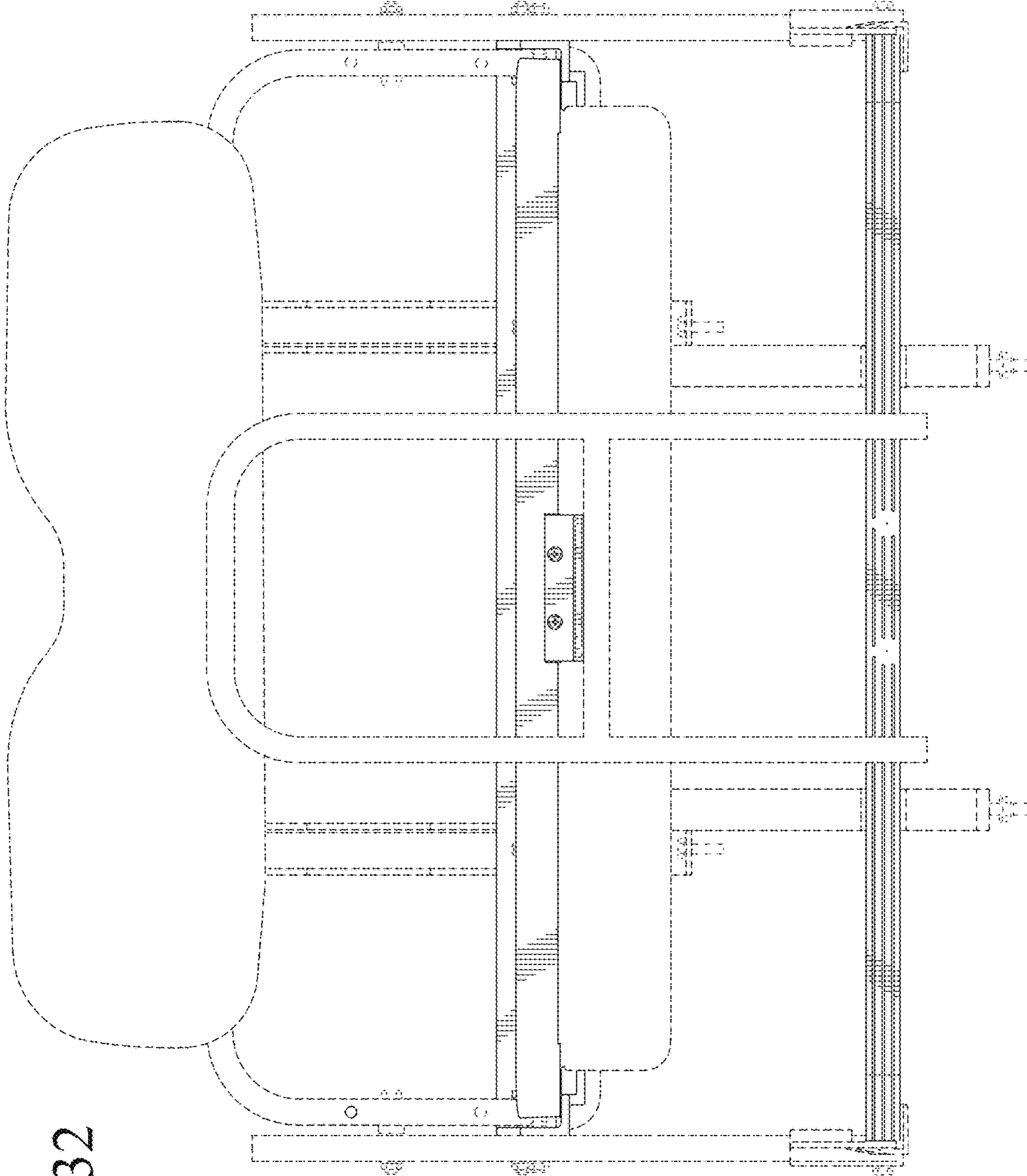
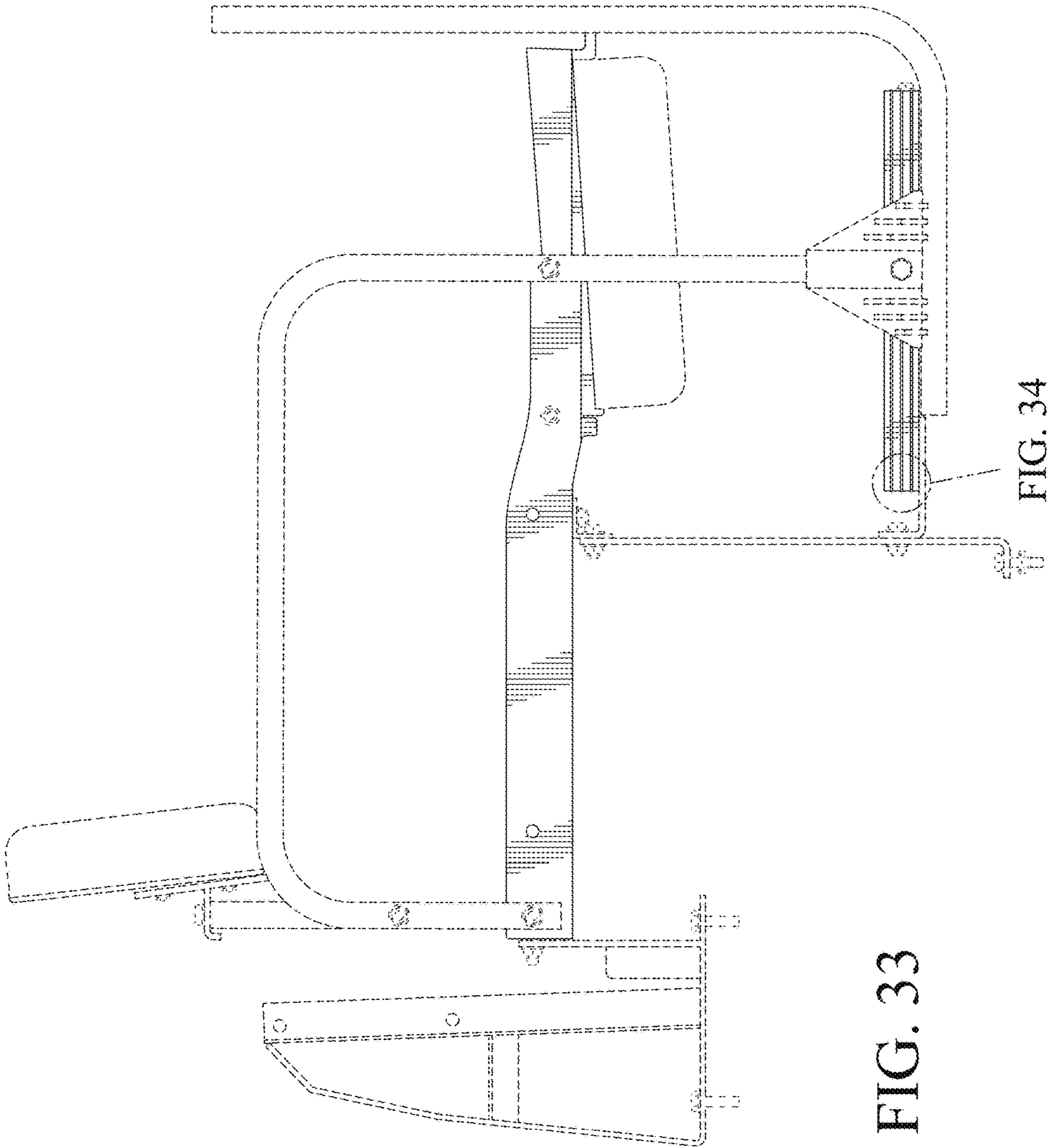

FIG. 32





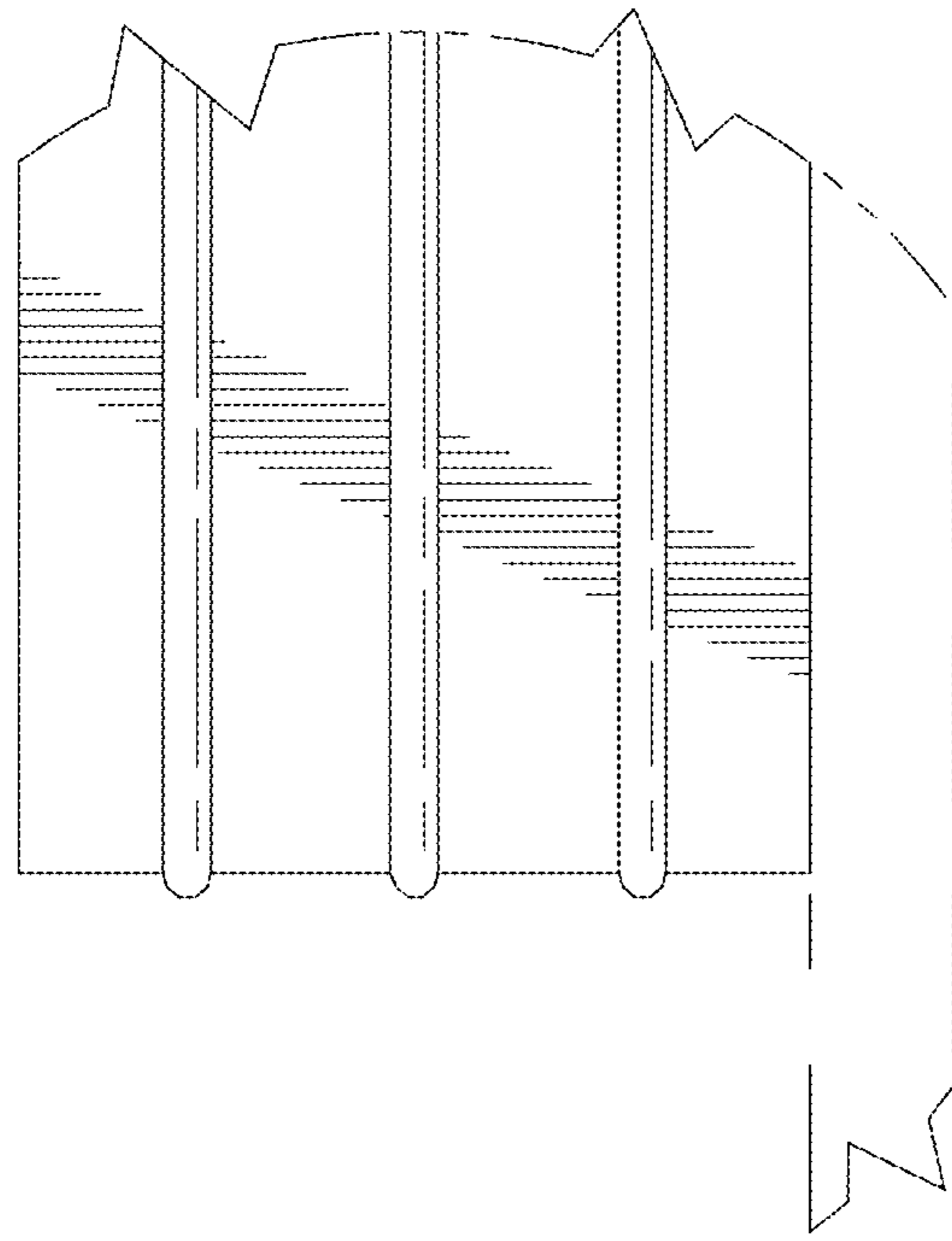

FIG. 34

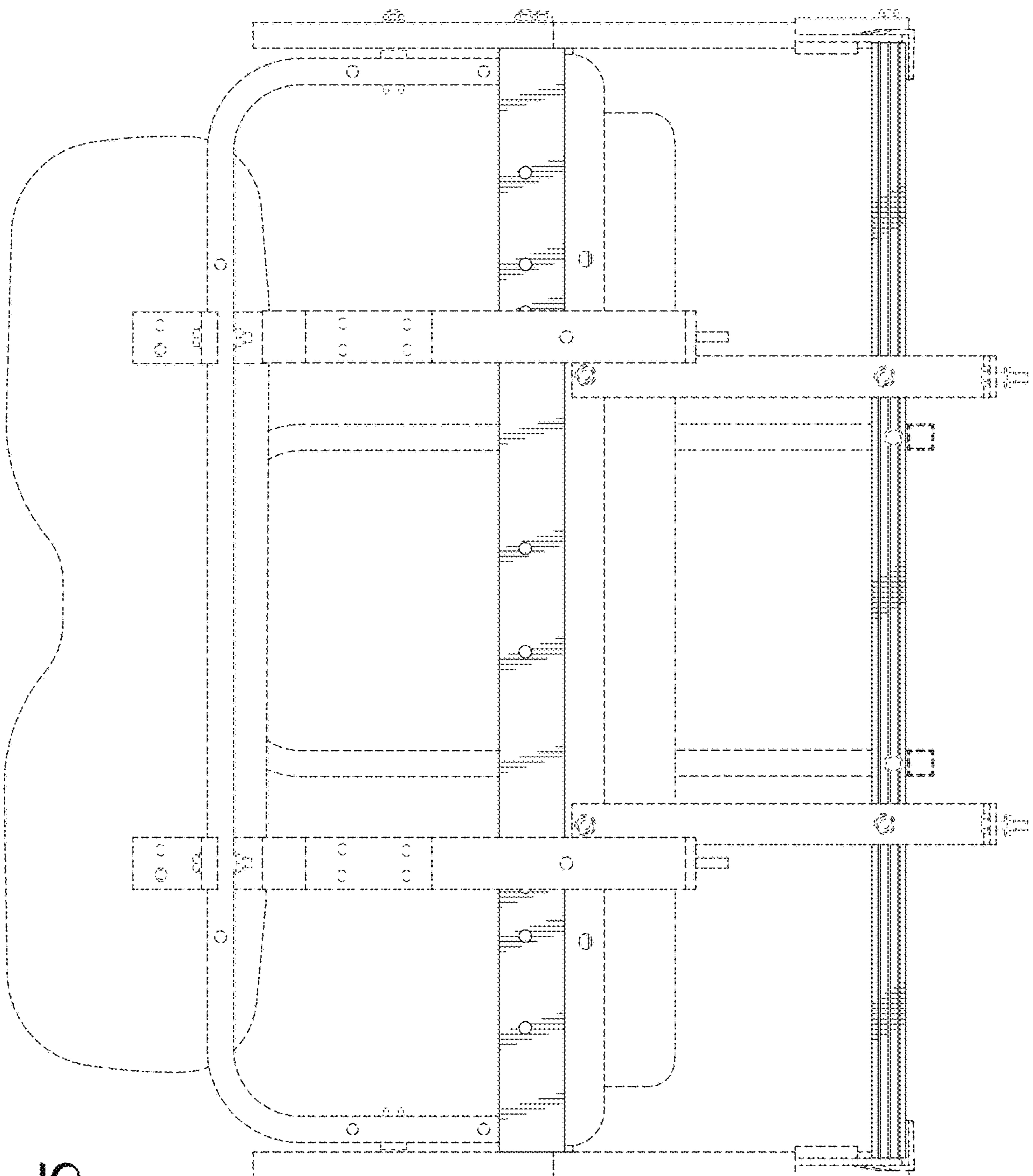

FIG. 35

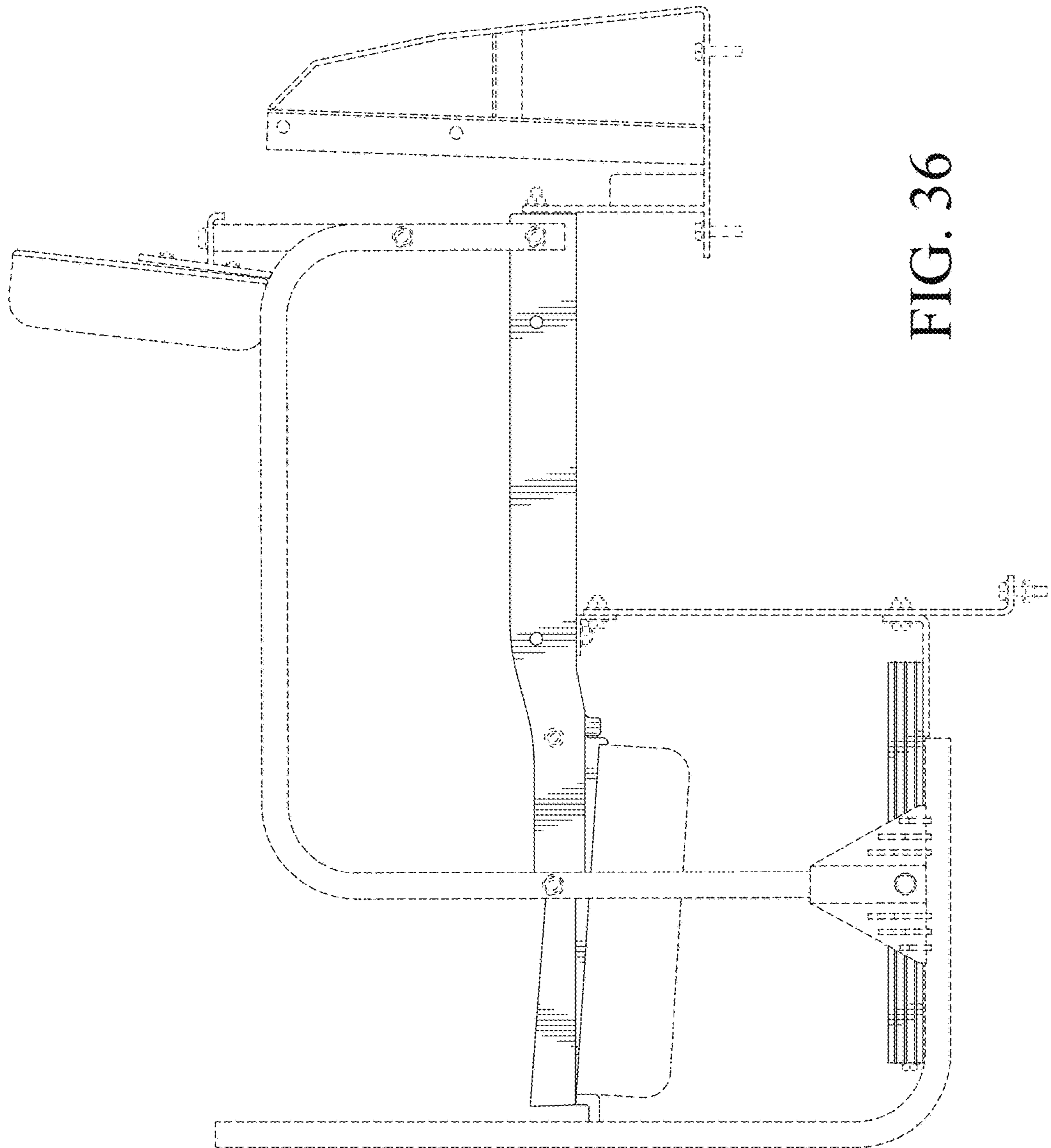

FIG. 36

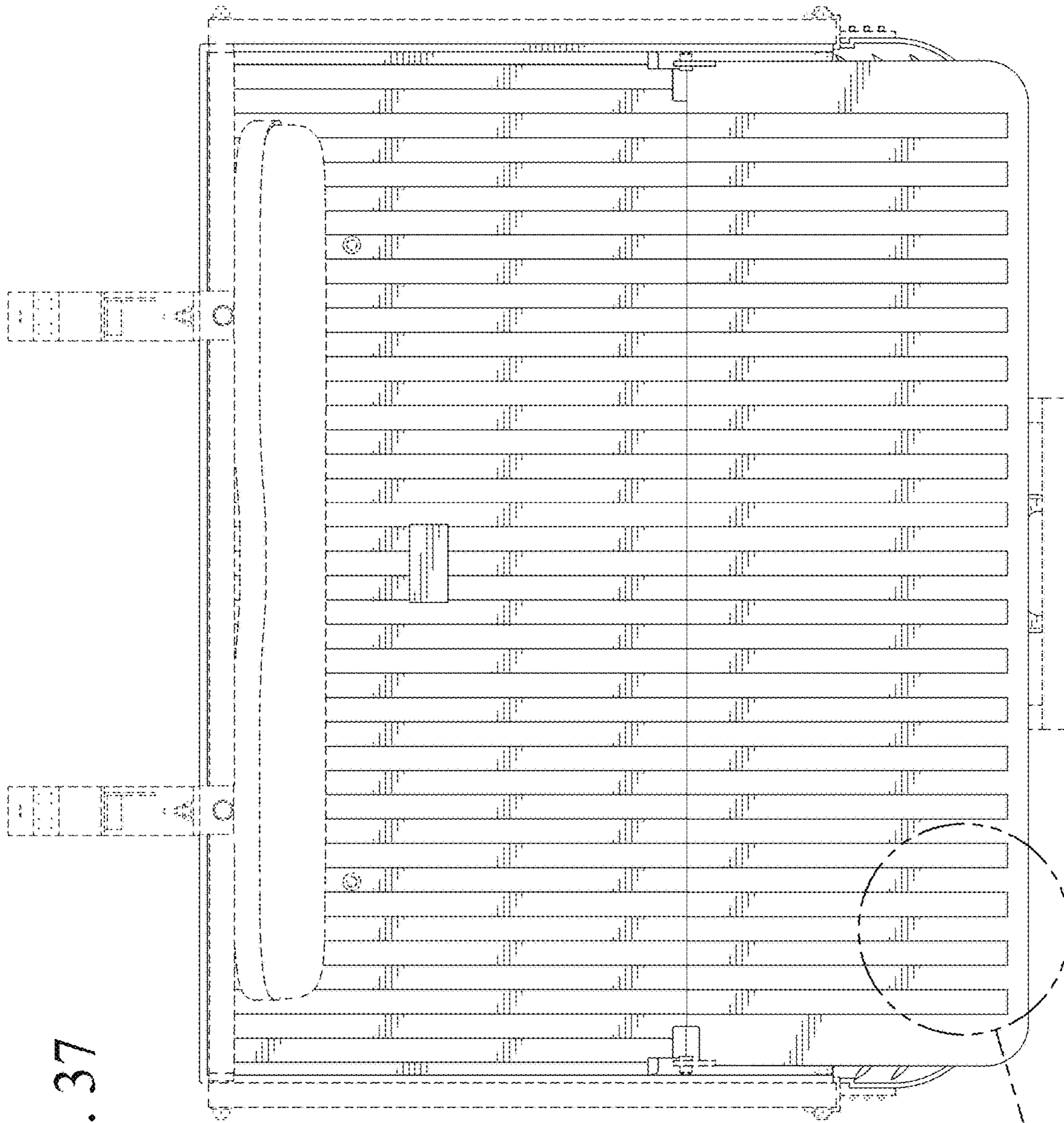

FIG. 37

FIG. 39

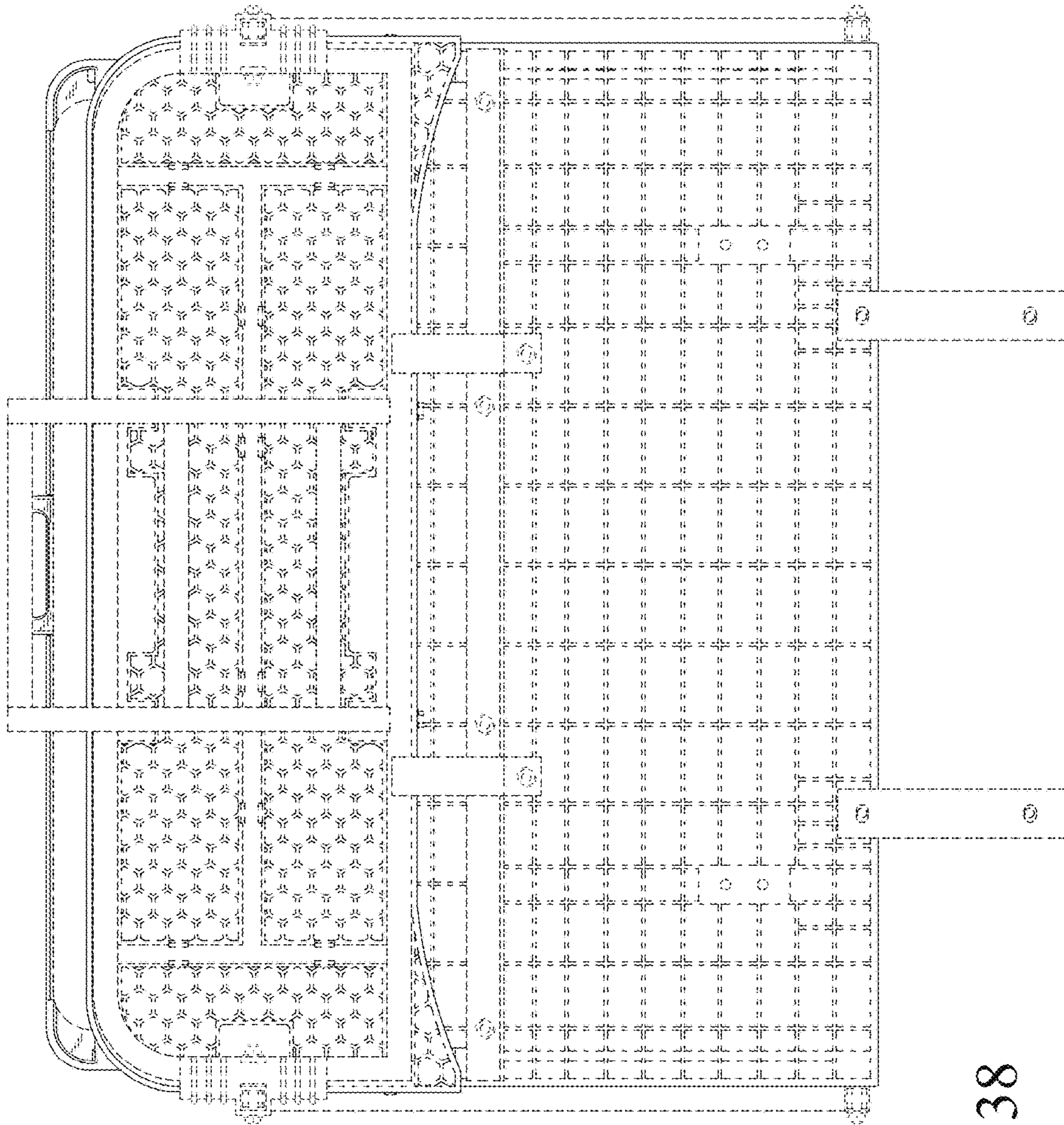

FIG. 38

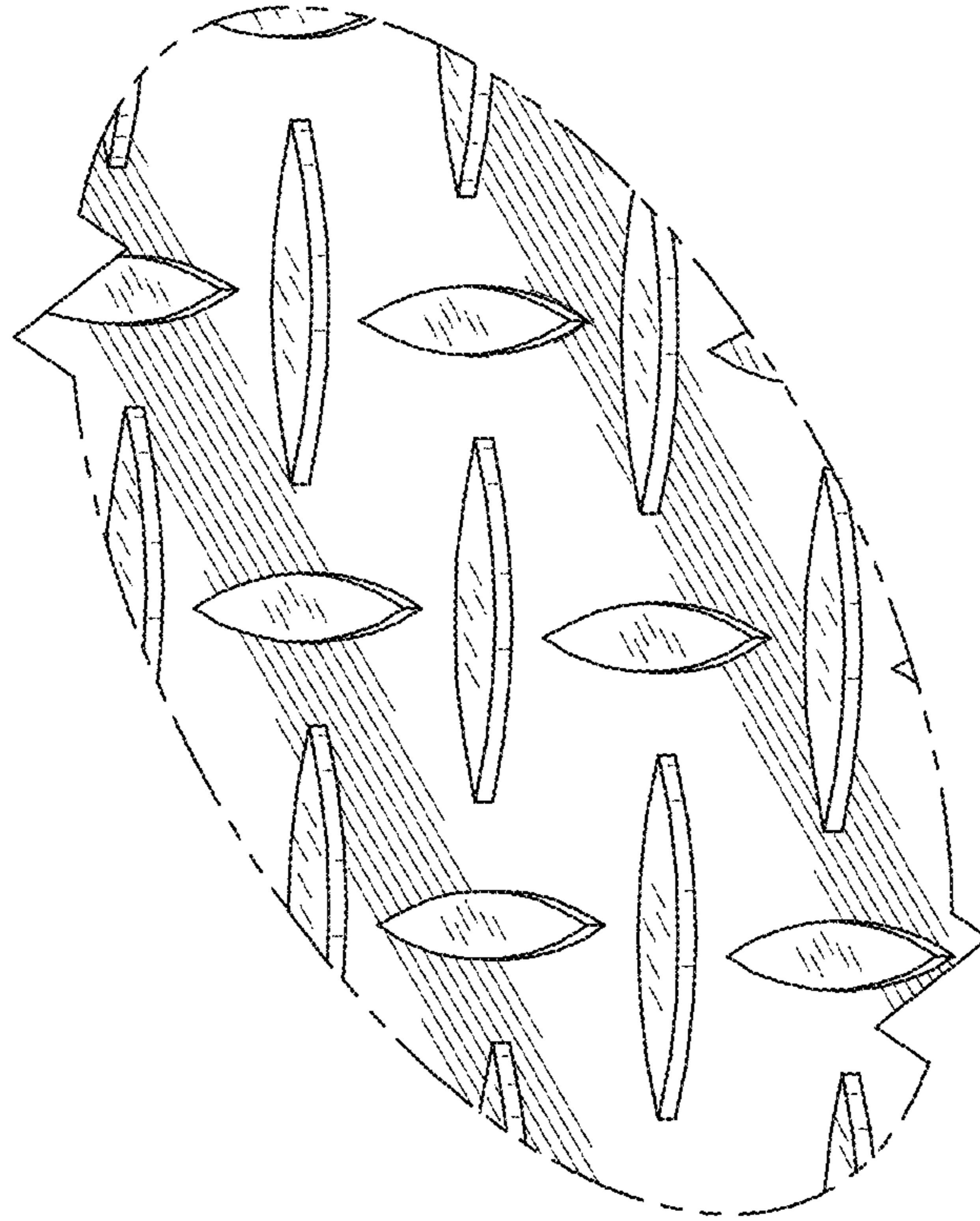

FIG. 39

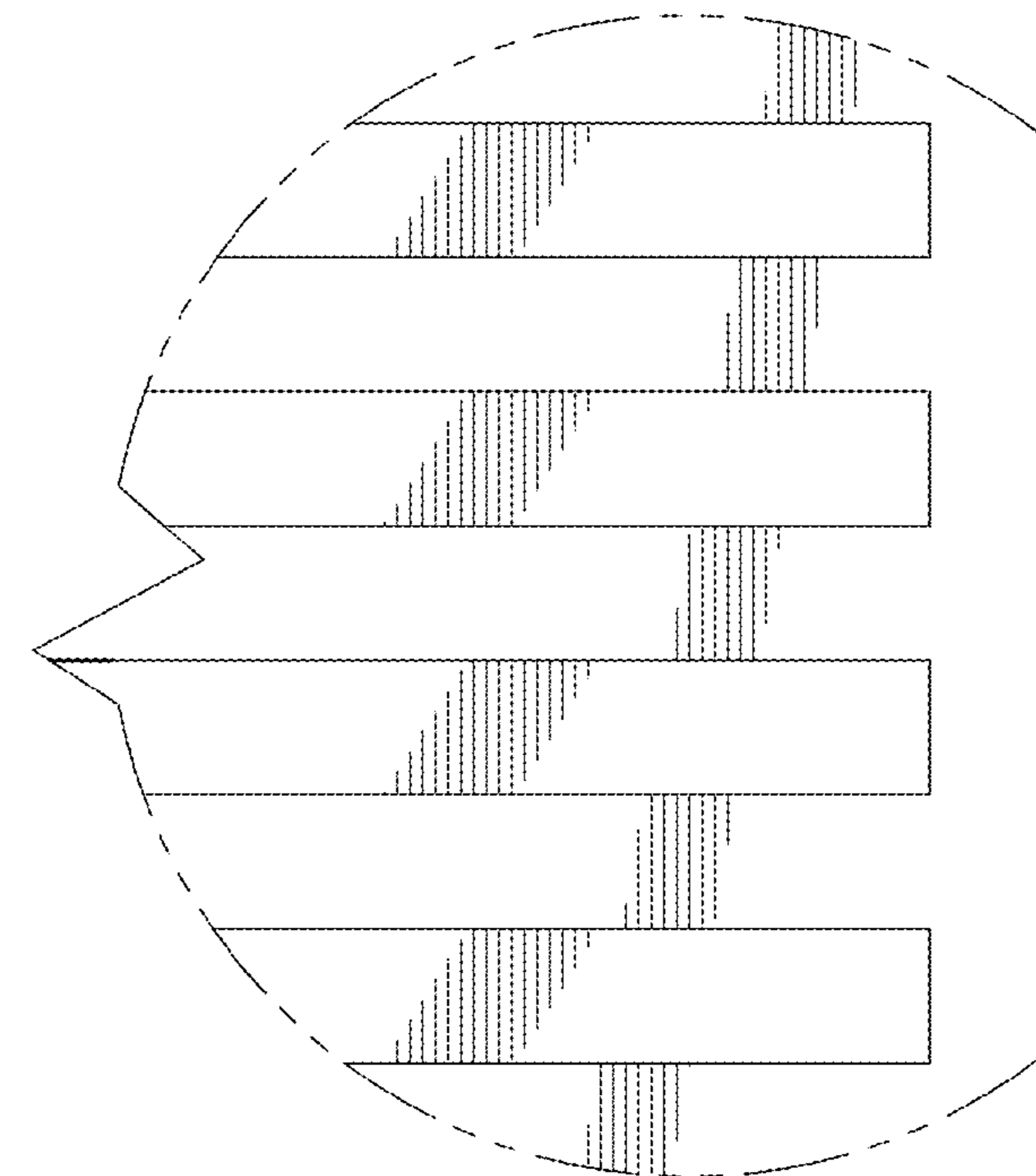

FIG. 40