



US00D814264S

(12) **United States Design Patent** (10) **Patent No.:** **US D814,264 S**
Werdowatz (45) **Date of Patent:** **** Apr. 3, 2018**

(54) **REUSABLE SHOPPING BAG HANDLE GRIP**

(71) Applicant: **Jack Werdowatz**, Temecula, CA (US)

(72) Inventor: **Jack Werdowatz**, Temecula, CA (US)

(**) Term: **15 Years**

(21) Appl. No.: **29/553,582**

(22) Filed: **Feb. 3, 2016**

(51) **LOC (11) Cl.** **08-06**

(52) **U.S. Cl.**
USPC **D8/303; D9/434**

(58) **Field of Classification Search**
USPC D8/300, 301, 302, 303, 307, 321;
D9/434; D7/393-395
CPC A45F 5/1046; A45F 2005/1073; A45F
5/1026; A45F 5/10; A45F 2005/1033;
Y10T 16/4576; Y10T 16/469; Y10T
16/476; Y10T 16/466; Y10T 74/20828;
Y10T 16/4559; Y10T 16/455; Y10T
16/44; Y10T 74/2087; Y10T 24/15; B65D
33/06; B65D 33/065; B65D 75/56; B65D
33/105; A63B 55/408; A63B 55/406
See application file for complete search history.

(56) **References Cited**

U.S. PATENT DOCUMENTS

| | | |
|-------------|---------|------------|
| 1,468,848 A | 9/1923 | Wear |
| 1,576,546 A | 3/1926 | Ransom |
| 2,041,691 A | 5/1936 | Becklin |
| 2,364,105 A | 12/1944 | Socke |
| 2,444,558 A | 7/1948 | Elliott |
| 2,448,894 A | 9/1948 | Laus |
| 2,506,781 A | 5/1950 | Elliott |
| 2,846,714 A | 8/1958 | Charlick |
| 3,083,366 A | 3/1963 | Mitrovacki |
| 3,800,361 A | 4/1974 | Stauffer |
| 4,004,722 A | 1/1977 | Olivier |
| D300,506 S | 4/1989 | Pedone |

| | | |
|---------------|---------|--------------------------------------|
| 4,890,355 A | 1/1990 | Schulten |
| 4,902,060 A | 2/1990 | Nobakht |
| 4,923,235 A | 5/1990 | Stewart |
| 4,936,619 A * | 6/1990 | Salazar A45F 5/1046 294/171 |
| 5,029,926 A | 7/1991 | Dieterich, Jr. |
| D319,569 S * | 9/1991 | Clark D9/434 |
| D325,156 S | 4/1992 | Sweeny |
| D325,509 S | 4/1992 | Cameron |
| D326,127 S * | 5/1992 | Rink D21/694 |
| D329,973 S | 10/1992 | Schuttinga |
| D362,181 S | 9/1995 | Meyers et al. |
| D363,664 S | 10/1995 | Muchnick |
| D367,817 S | 3/1996 | Halpin et al. |
| D368,011 S | 3/1996 | McCoy |

(Continued)

Primary Examiner — Lauren R Calve

(74) *Attorney, Agent, or Firm* — Kirk A. Buhler; Buhler & Associates

(57) **CLAIM**

The ornamental design for a reusable shopping bag handle grip, as shown and described.

DESCRIPTION

FIG. 1 is a bottom perspective view of a reusable shopping bag handle grip showing my new design; FIG. 2 is a top plan view thereof; FIG. 3 is a bottom plan view thereof; FIG. 4 is a front elevation view, the rear elevation view being a mirror image; FIG. 5 is a front sectional view thereof, taken along lines 5-5 from FIG. 3; FIG. 6 is a left side elevation view of FIG. 1, the right side elevation view being a mirror image; FIG. 7 is a left side sectional view thereof, taken along lines 7-7 from FIG. 3; and, FIG. 8 is a top perspective view of FIG. 1. The broken lines shown represent unclaimed subject matter and form no part of the claimed design.

1 Claim, 4 Drawing Sheets

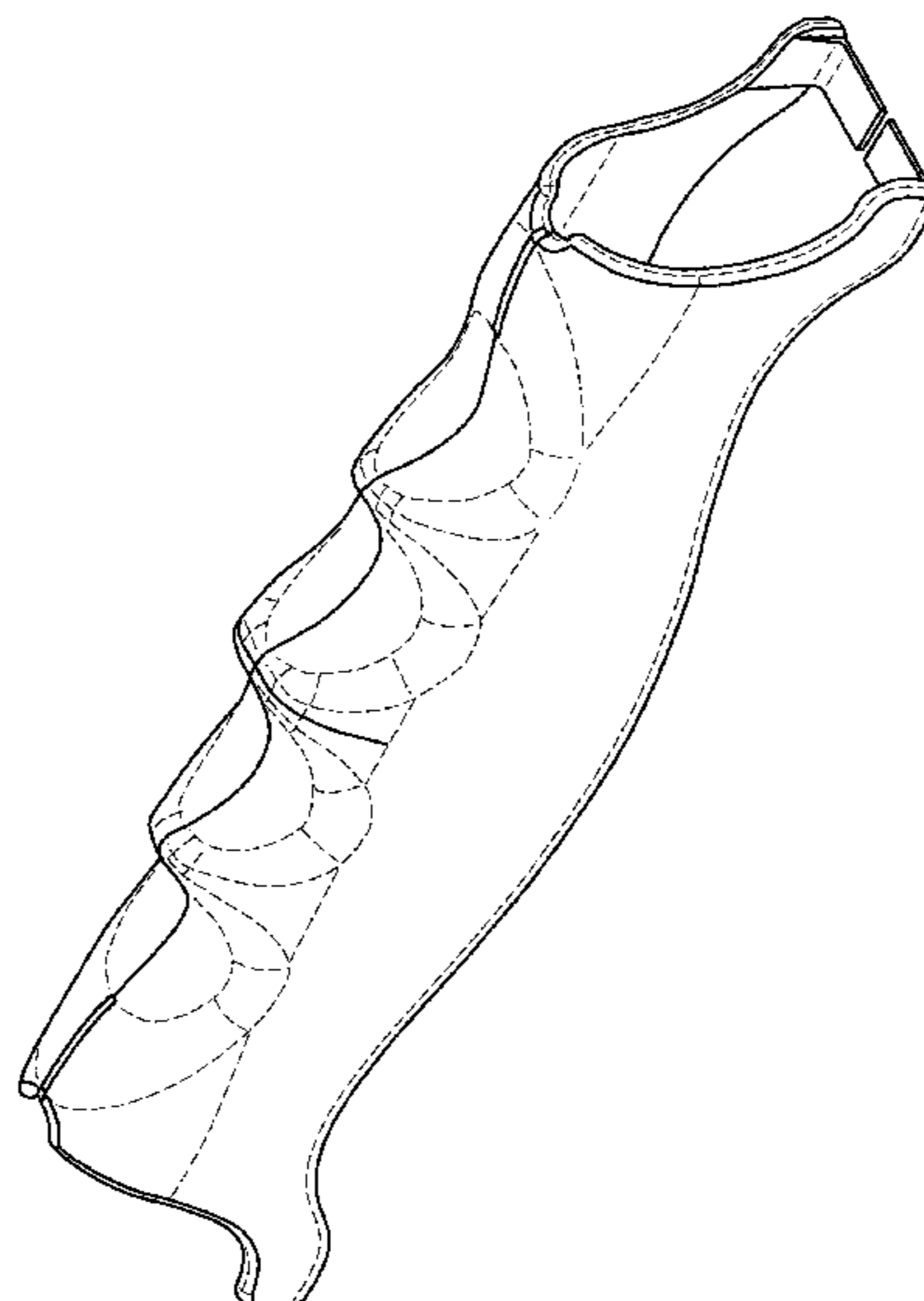

(56)

References Cited

U.S. PATENT DOCUMENTS

| | | | | | |
|--------------|---------|--------------------|-------------------|---------|------------------------------------|
| D369,549 S | 5/1996 | Meyers et al. | D574,233 S | 8/2008 | Young, Sr. |
| D369,745 S | 5/1996 | Kitazaki | D624,411 S | 8/2010 | Puerta |
| D372,425 S | 8/1996 | Kirkwood | D647,801 S | 11/2011 | Werdowatz |
| D372,865 S | 8/1996 | Stowell et al. | D770,877 S * | 11/2016 | Pitchforth D3/246 |
| D374,621 S | 10/1996 | Salazar, Jr. | D775,926 S * | 1/2017 | Atkins D8/303 |
| D384,279 S | 9/1997 | Hepworth | 9,545,142 B2 * | 1/2017 | Pitchforth A45F 5/1046 |
| D401,505 S | 11/1998 | Michael et al. | D778,706 S * | 2/2017 | Atkins D8/303 |
| D403,035 S | 12/1998 | MacPherson | 2003/0102684 A1 | 6/2003 | Shinmoto et al. |
| D430,029 S | 8/2000 | Folmar | 2005/0017530 A1 | 1/2005 | Lima |
| D436,036 S | 1/2001 | Manseau | 2005/0258661 A1 | 11/2005 | Castro |
| D440,492 S | 4/2001 | Ellers | 2005/0285421 A1 | 12/2005 | Novakovich et al. |
| D448,992 S | 10/2001 | Bargsten | 2006/0163894 A1 | 7/2006 | Mishek et al. |
| D456,264 S | 4/2002 | Lalande | 2007/0024072 A1 | 2/2007 | Leon |
| D467,498 S | 12/2002 | Taylor | 2007/0050948 A1 * | 3/2007 | Palmer A45F 5/1026 16/422 |
| D489,976 S | 5/2004 | Whitney | 2007/0085360 A1 | 4/2007 | Porter |
| D489,977 S | 5/2004 | Robberstad | 2007/0187967 A1 | 8/2007 | Smith |
| D498,592 S | 11/2004 | Kelley | 2007/0246959 A1 | 10/2007 | Arcaro et al. |
| D529,333 S * | 10/2006 | Zemel D7/393 | 2008/0061574 A1 | 3/2008 | Seki |
| D566,546 S | 4/2008 | Williamson | 2014/0292011 A1 | 10/2014 | Liszkiewicz |
| | | | 2015/0257518 A1 | 9/2015 | Burkman |
| | | | 2017/0073114 A1 * | 3/2017 | Cartlidge B65D 25/32 |

* cited by examiner

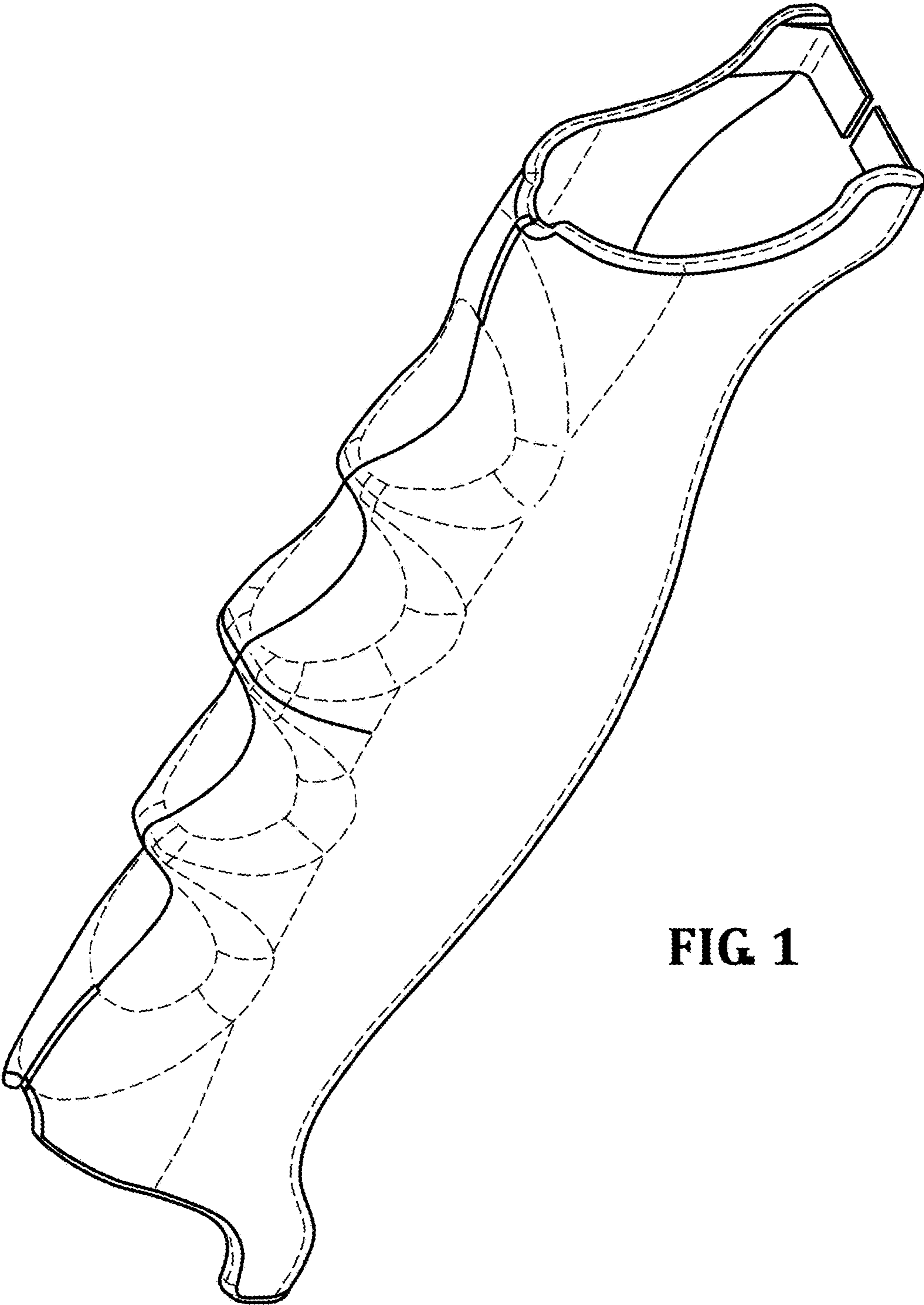

FIG 1

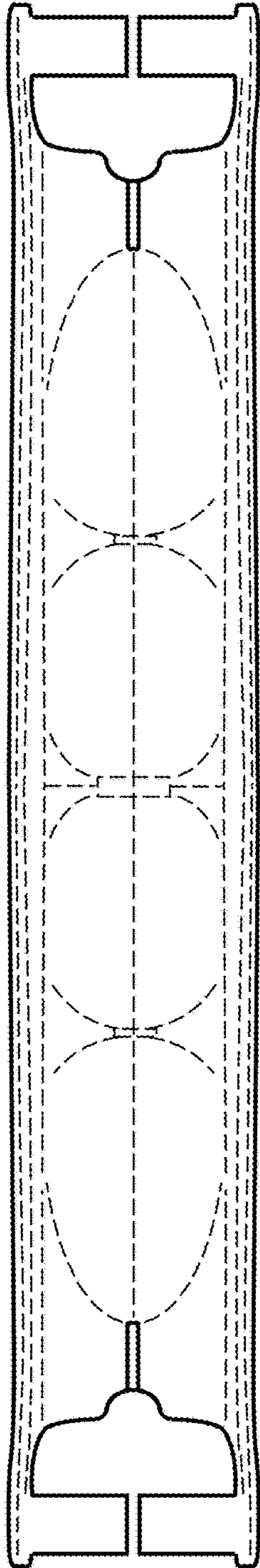

FIG 2

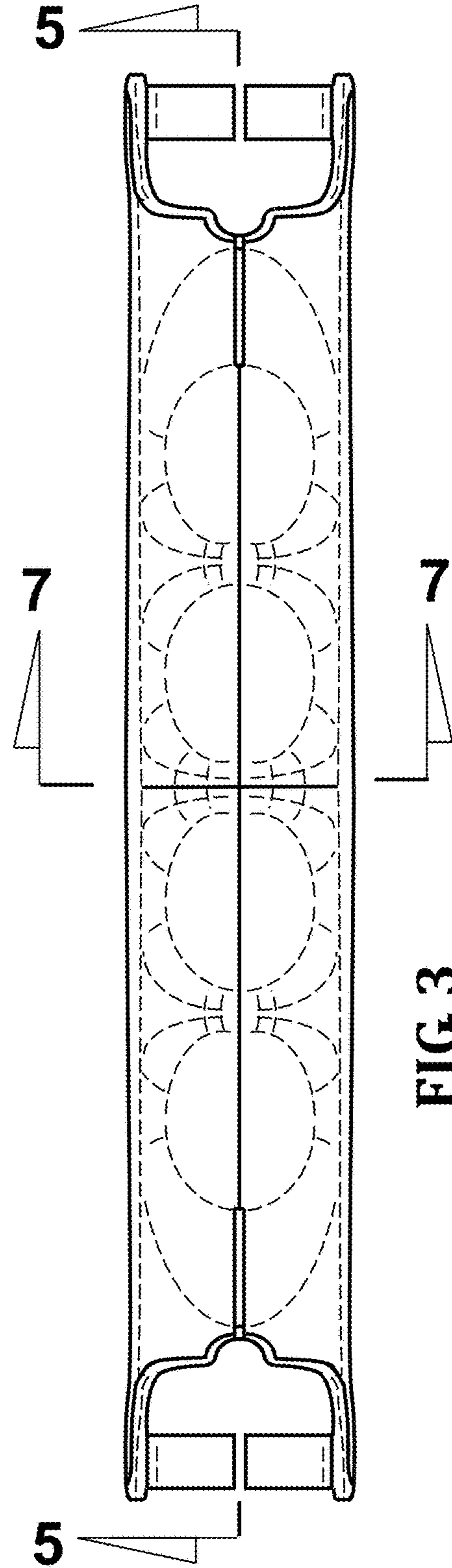

FIG 3

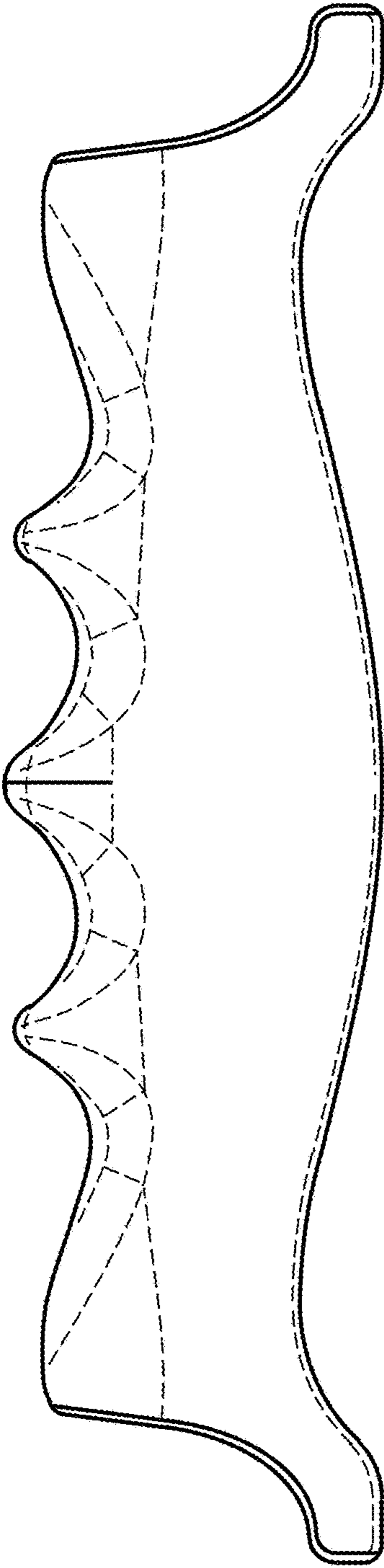

FIG 4

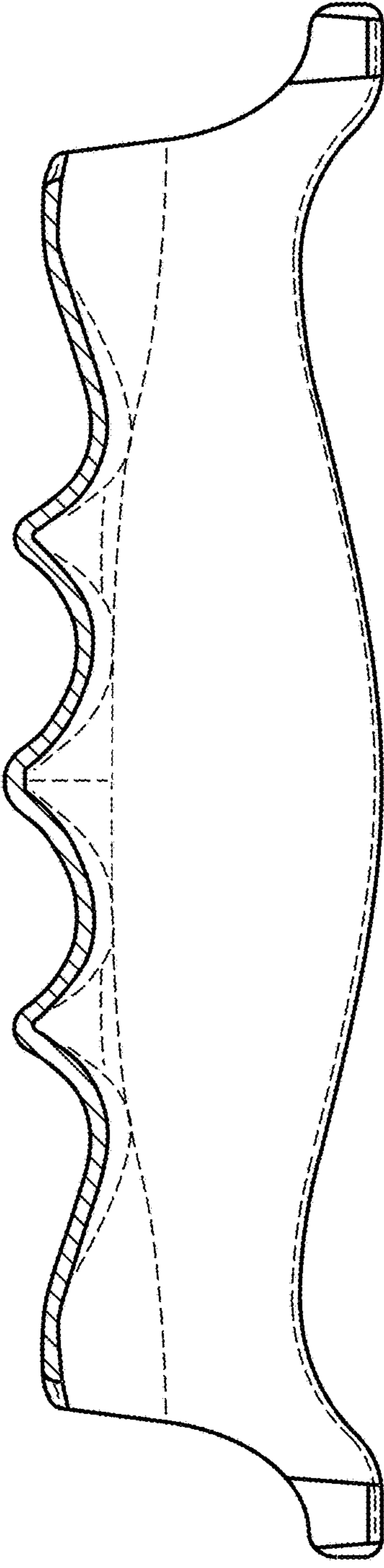

FIG 5

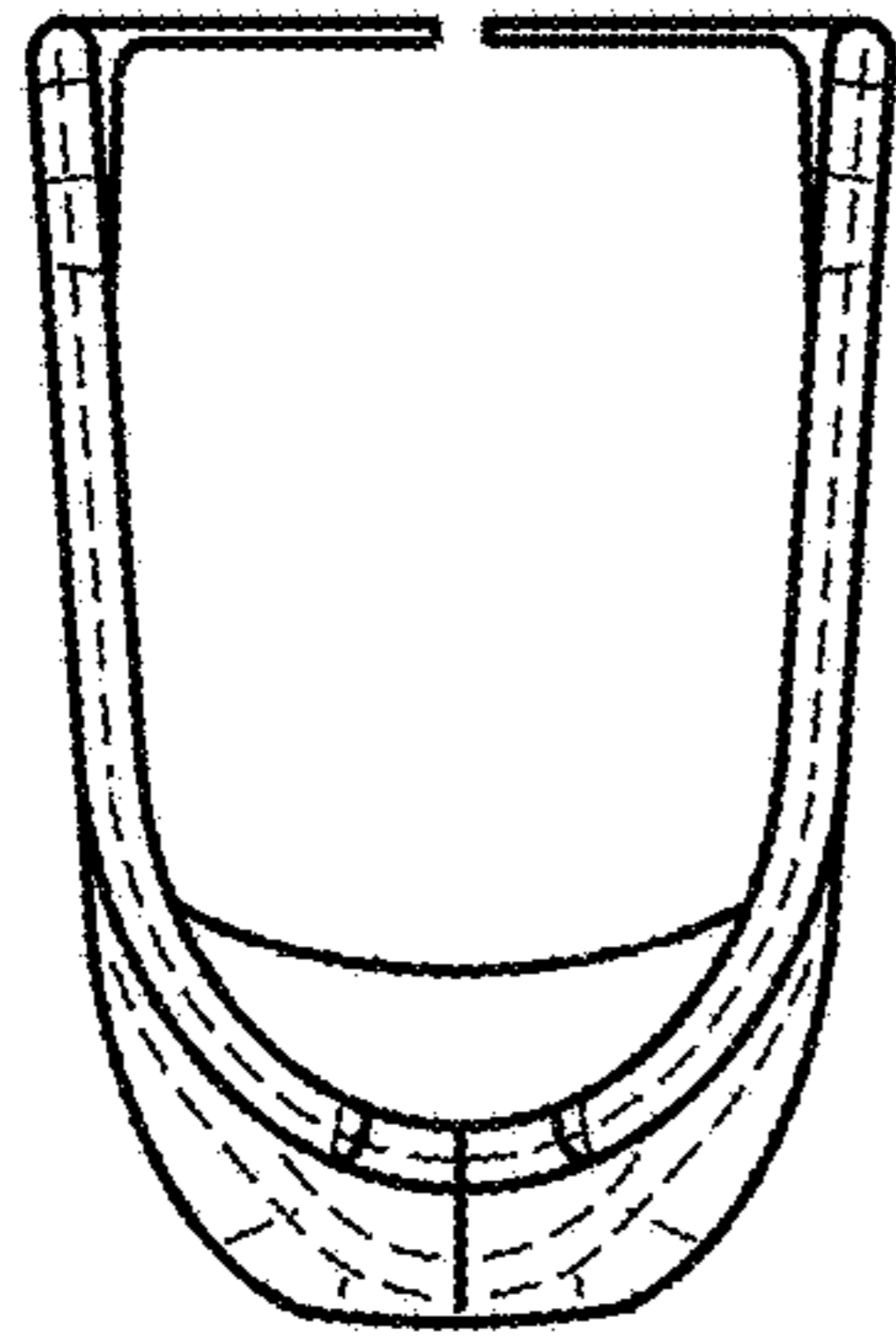

FIG. 6

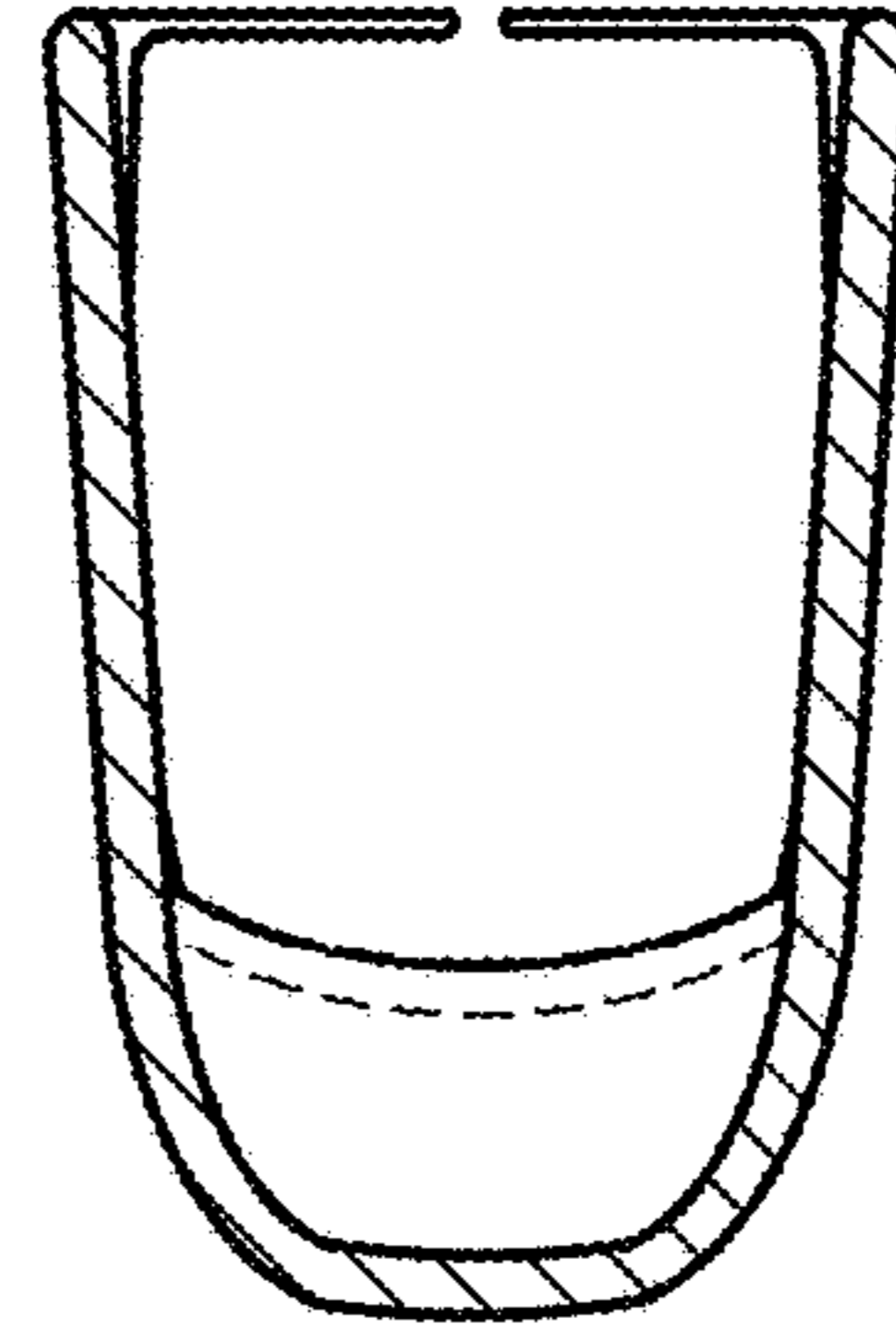

FIG. 7

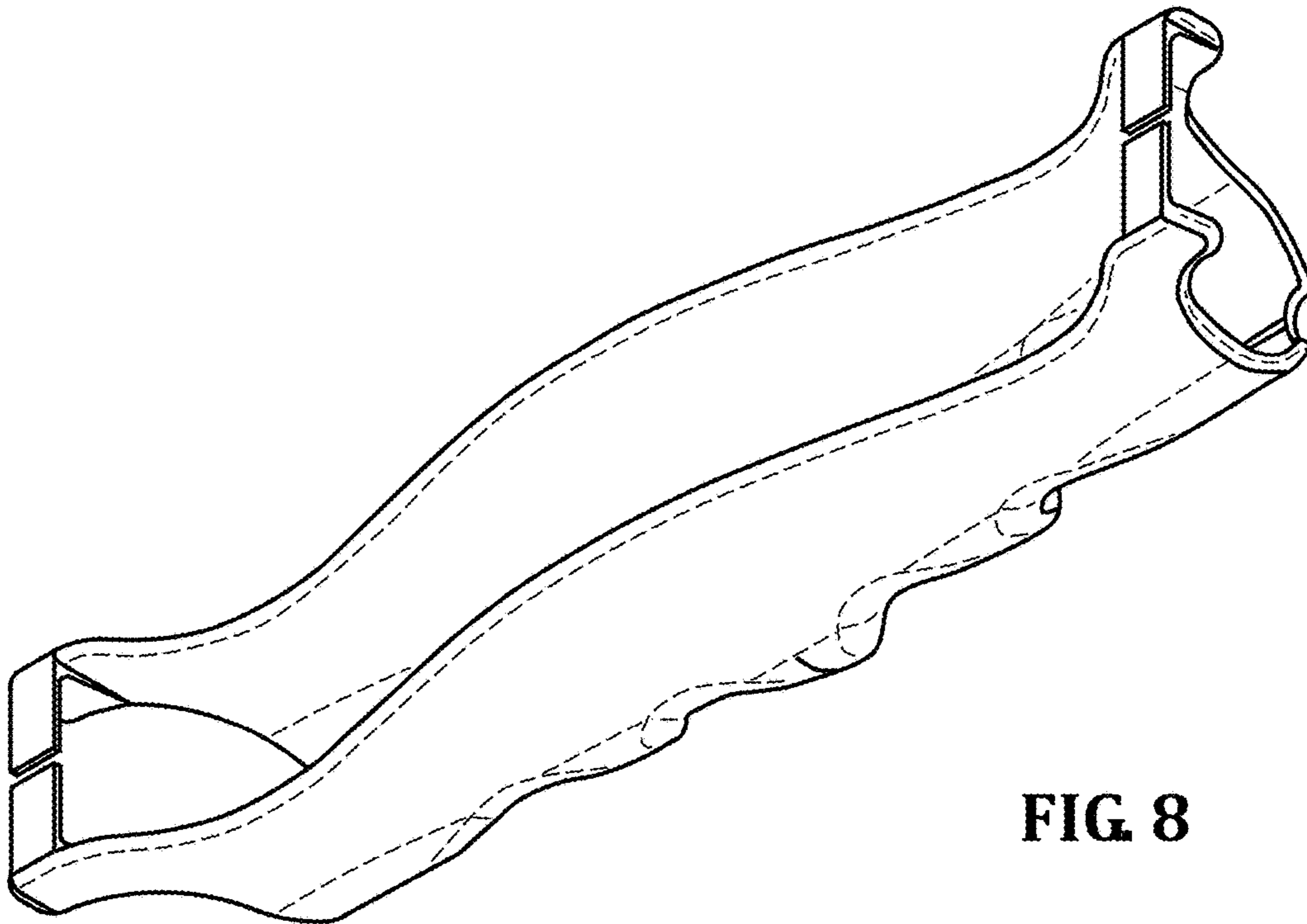

FIG. 8