



US00D814084S

(12) **United States Design Patent** (10) **Patent No.:** **US D814,084 S**
James et al. (45) **Date of Patent:** **** Mar. 27, 2018**

(54) **LAMP**

(71) Applicant: **Cinco Design Office Inc.**, Portland, OR (US)

(72) Inventors: **Kirk L. James**, Portland, OR (US);
Beverly N. Moon, Portland, OR (US);
Michael A. Qualls, Portland, OR (US);
Matt V. Capozzi, Portland, OR (US);
Nicolas B. Ramirez, Portland, OR (US)

(73) Assignee: **Cinco Design Office Inc.**, Portland, OR (US)

(**) Term: **15 Years**

(21) Appl. No.: **29/575,958**

(22) Filed: **Aug. 30, 2016**

(51) **LOC (11) Cl.** **26-02**

(52) **U.S. Cl.**
USPC **D26/41**

(58) **Field of Classification Search**
USPC D26/37, 41

(Continued)

(56) **References Cited**

U.S. PATENT DOCUMENTS

D561,365 S * 2/2008 Huff D26/37
D598,150 S * 8/2009 Bertken D26/37
(Continued)

OTHER PUBLICATIONS

Big Game, BLUR Lamp, www.big-game.ch/media/images/10052009162729_s.jpg, 2009.

(Continued)

Primary Examiner — Brian N. Vinson

(74) *Attorney, Agent, or Firm* — Dascenzo Intellectual Property Law, P.C.

(57) **CLAIM**

The ornamental design for a lamp, as shown and described.

DESCRIPTION

FIG. 1 is an isometric view of a lamp showing the new design;

FIG. 2 is an isometric view thereof with the handle omitted for clarity;

FIG. 3 is another isometric view thereof with the handle omitted for clarity;

FIG. 4 is a side view thereof with the handle omitted for clarity;

FIG. 5 is another side view thereof with the handle omitted for clarity;

FIG. 6 is another side view thereof with the handle omitted for clarity;

FIG. 7 is another side view thereof with the handle omitted for clarity;

FIG. 8 is a top view thereof with the handle omitted for clarity;

FIG. 9 is a bottom view thereof;

FIG. 10 is a side view thereof with the base omitted for clarity;

FIG. 11 is an isometric view thereof with the handle and the base omitted for clarity;

FIG. 12 is another isometric view thereof with the handle and the base omitted for clarity;

FIG. 13 is a side view thereof with the handle and the base omitted for clarity;

FIG. 14 is a top view thereof with the handle and the base omitted for clarity;

FIG. 15 is a bottom view thereof with the handle and the base omitted for clarity;

FIG. 16 is an isometric view thereof with the base and the bulb omitted for clarity;

FIG. 17 is a side view thereof with the base and the bulb omitted for clarity;

FIG. 18 is another side view thereof with the base and the bulb omitted for clarity;

FIG. 19 is a top view thereof with the base and the bulb omitted for clarity;

FIG. 20 is a bottom view thereof with the base and the bulb omitted for clarity;

(Continued)

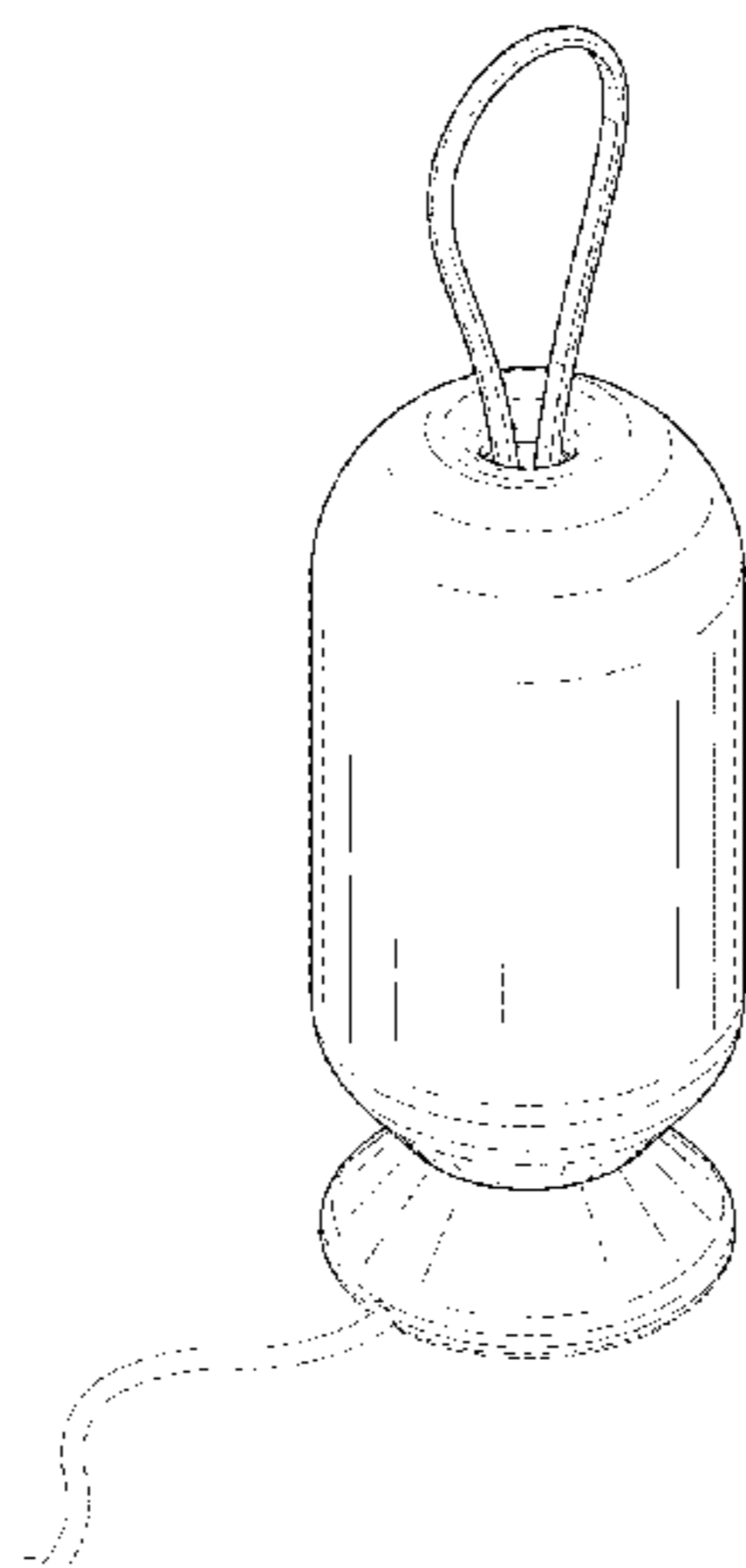

FIG. 21 is an isometric view thereof with the handle, the bulb, and the power cord omitted for clarity;
 FIG. 22 is another isometric view thereof with the handle, the bulb, and the power cord omitted for clarity;
 FIG. 23 is a side view thereof with the handle, the bulb, and the power cord omitted for clarity;
 FIG. 24 is another side view thereof with the handle, the bulb, and the power cord omitted for clarity;
 FIG. 25 is a top view thereof with the handle, the bulb, and the power cord omitted for clarity; and,
 FIG. 26 is a bottom view thereof with the handle, the bulb, and the power cord omitted for clarity.

The broken lines shown in the drawings represent portions of the lamp that form no part of the claimed design. The shading lines shown in the drawings do not indicate surface decoration.

1 Claim, 7 Drawing Sheets

(58) **Field of Classification Search**

CPC F21L 2003/00; F21L 4/00; F21L 4/005;
 F21L 4/02; F21L 4/025; F21L 4/027;
 F21L 4/04; F21L 4/08; F21L 2005/00;

F21L 7/00; F21L 11/00; F21L 13/00;
 F21L 13/04; F21L 13/08; F21L 14/02;
 F21L 17/00; F21L 19/00

See application file for complete search history.

(56)

References Cited

U.S. PATENT DOCUMENTS

D718,480	S	*	11/2014	Lee	D26/41
D740,475	S	*	10/2015	Pineau	D26/37
D783,872	S	*	4/2017	Aksnes	D26/41
D787,104	S	*	5/2017	Wu	D26/41
D791,992	S	*	7/2017	Hsu	D26/41

OTHER PUBLICATIONS

Alv Péerz, Reading Lamp, www.alypeerz.com/reading-lamp-lampara-de-lectura, downloaded Aug. 10, 2016.
 Hand & Eye Studio, Duo Table Lamp, handandeyestudio.co.uk/products/duo-table-lamp/, 2015.
 Industrial Facility, Muji Timer Light, www.industrialfacility.co.uk/page/clients/muji/timer-light, downloaded Aug. 10, 2016.
 KIIKKU table light, www.behance.net/gallery/12698489/KIIKKU, Dec. 1, 2013.

* cited by examiner

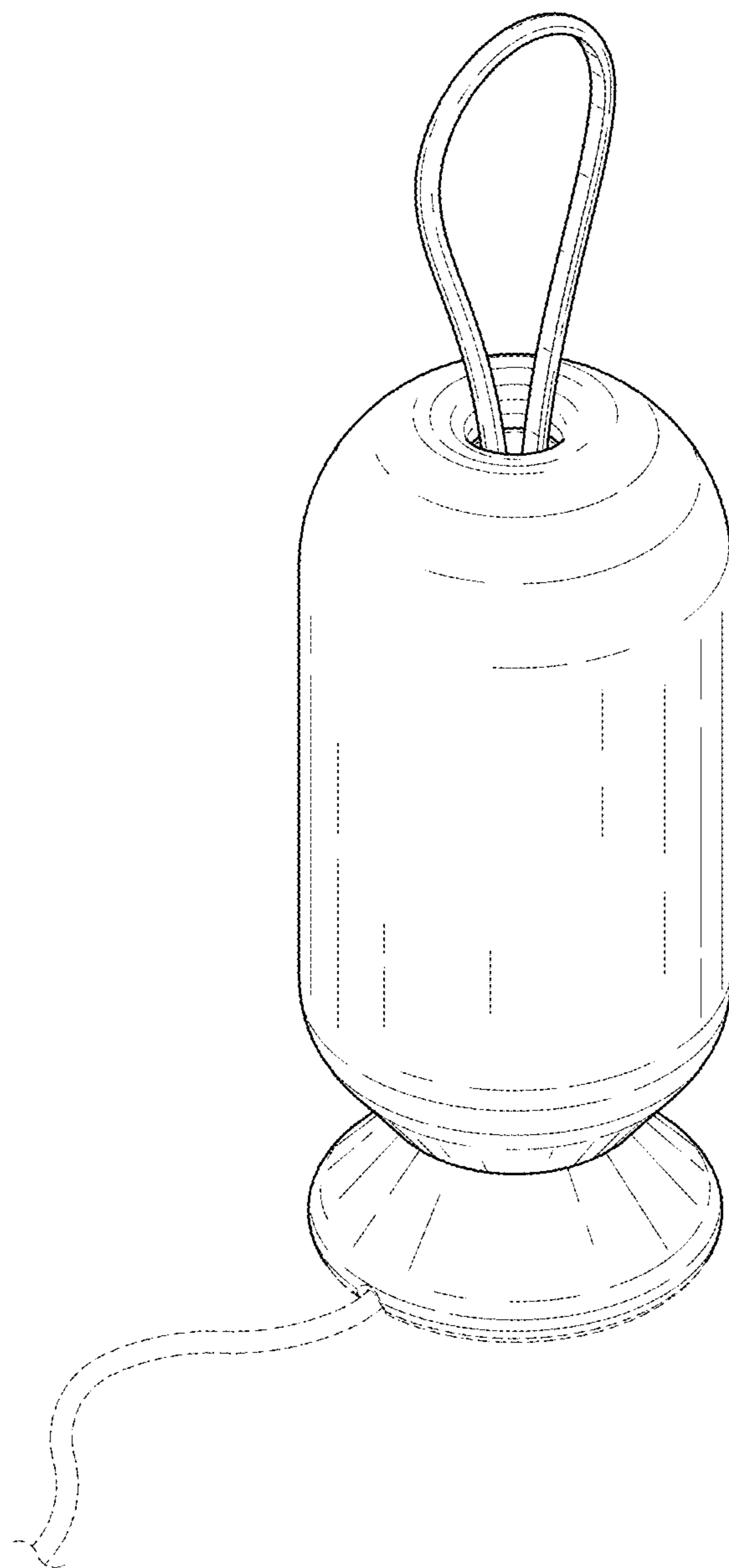

Fig. 1

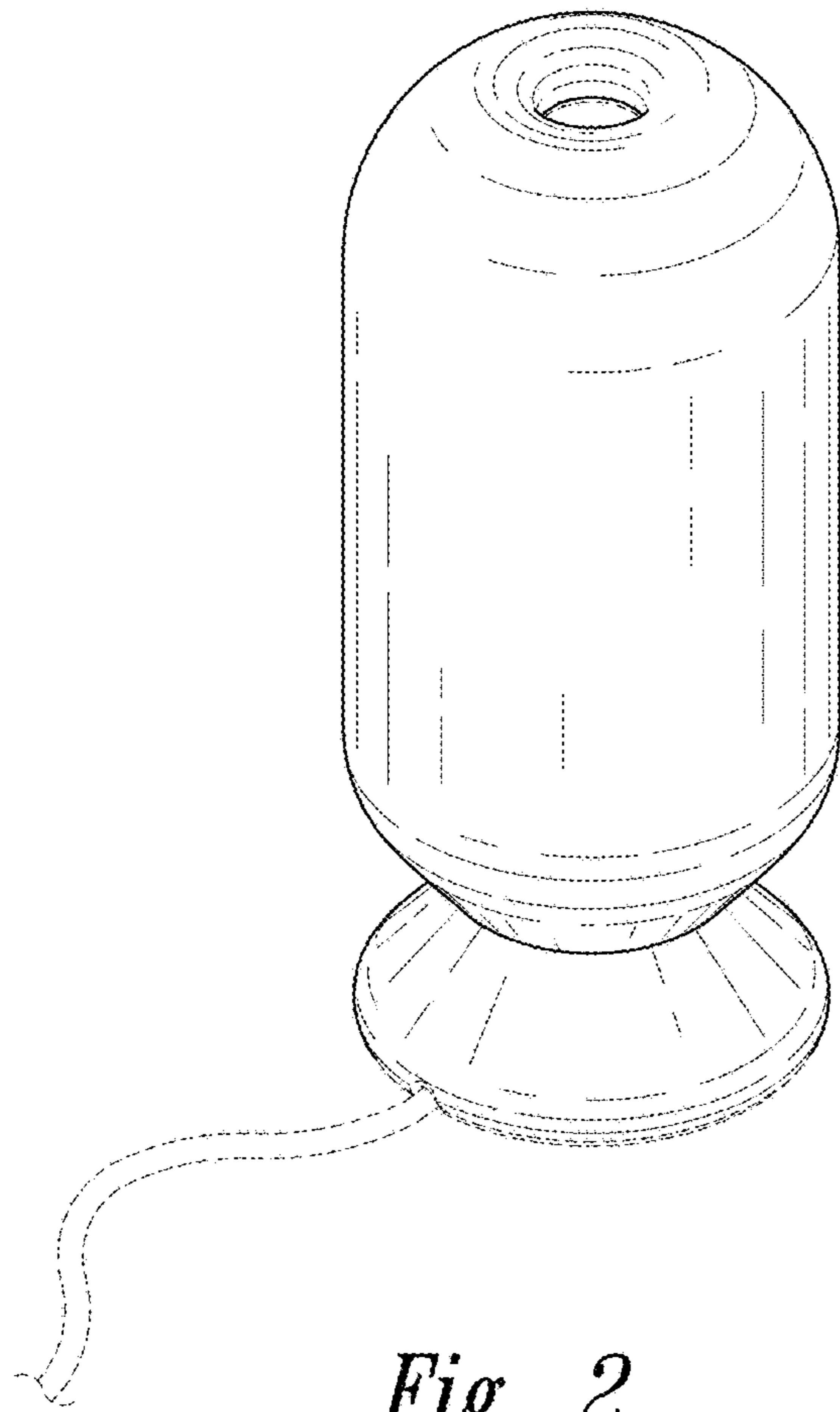

Fig. 2

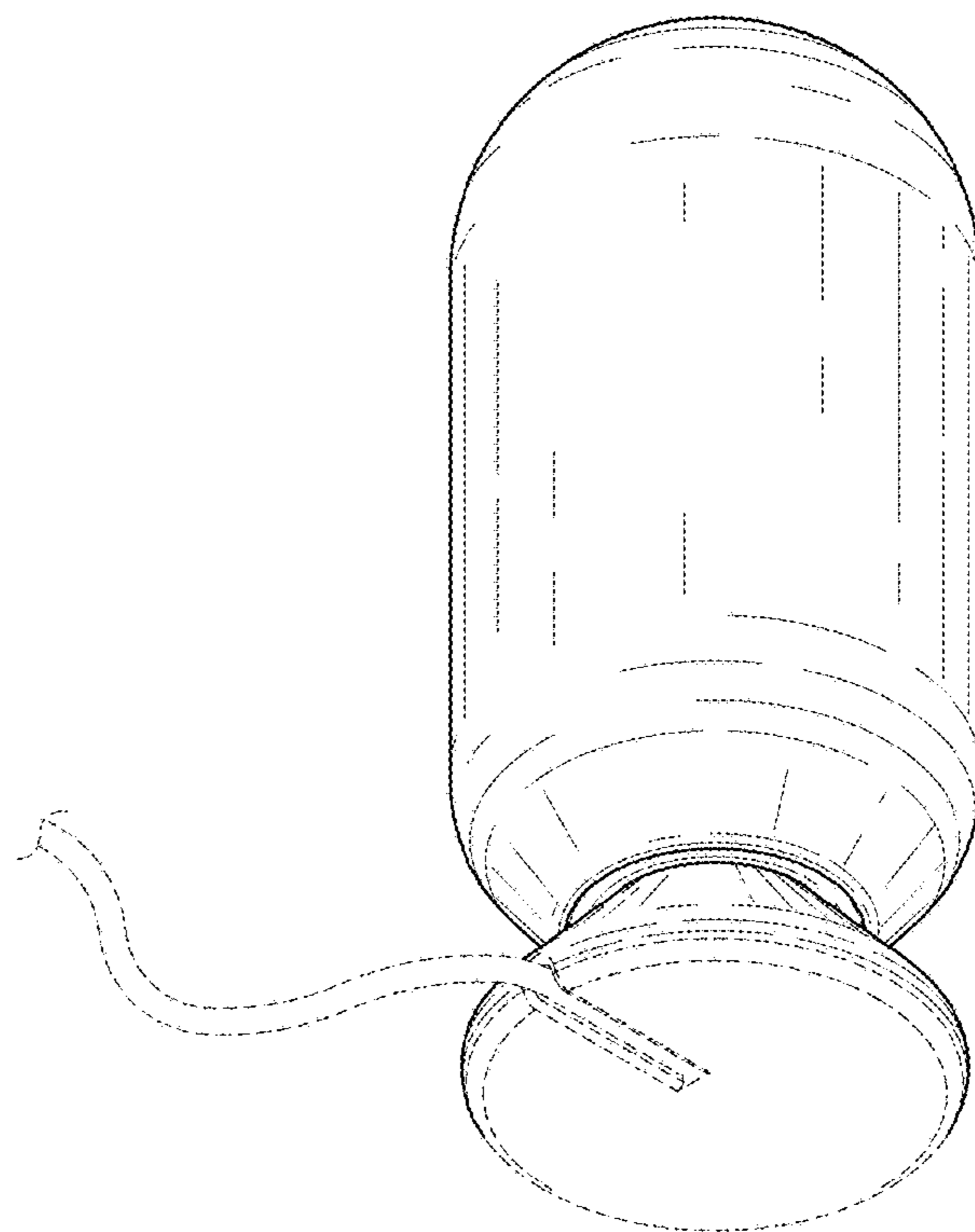

Fig. 3

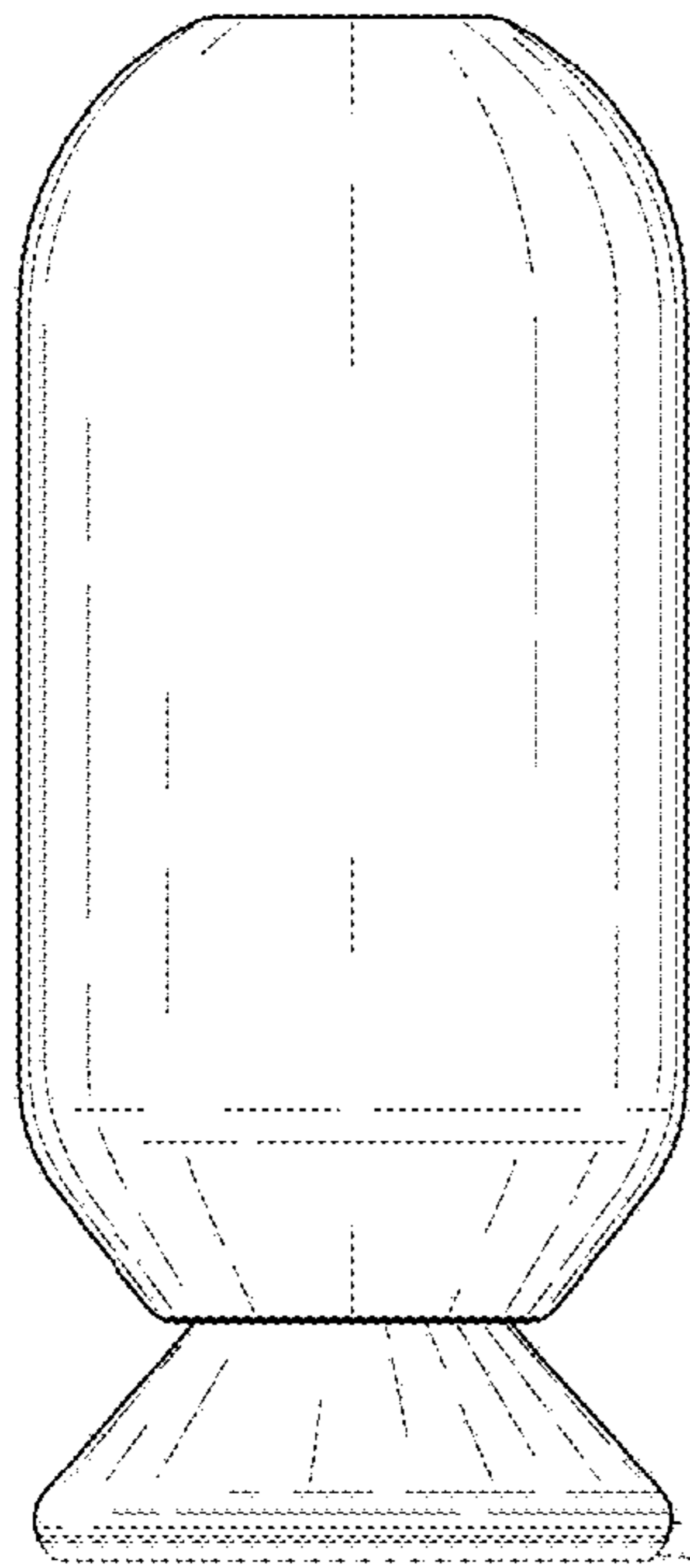

Fig. 4

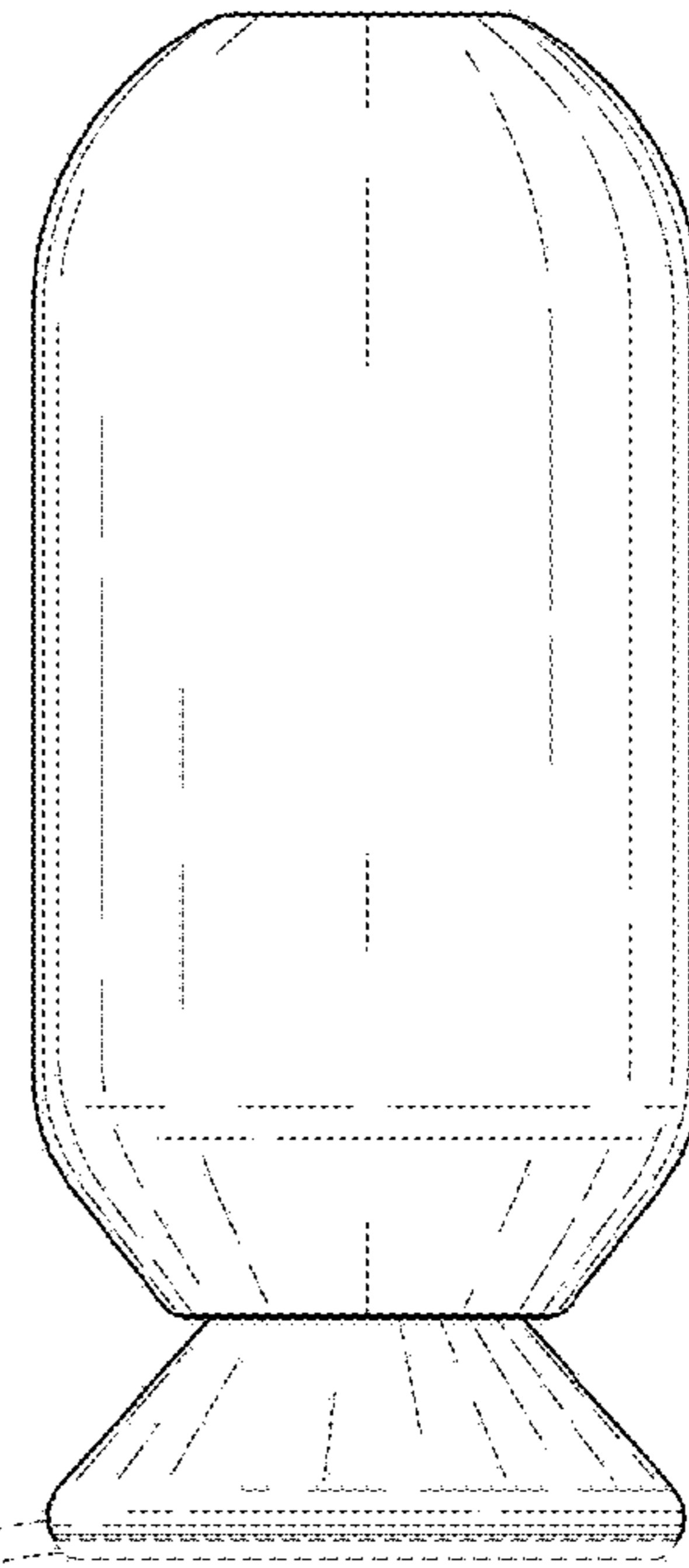

Fig. 5

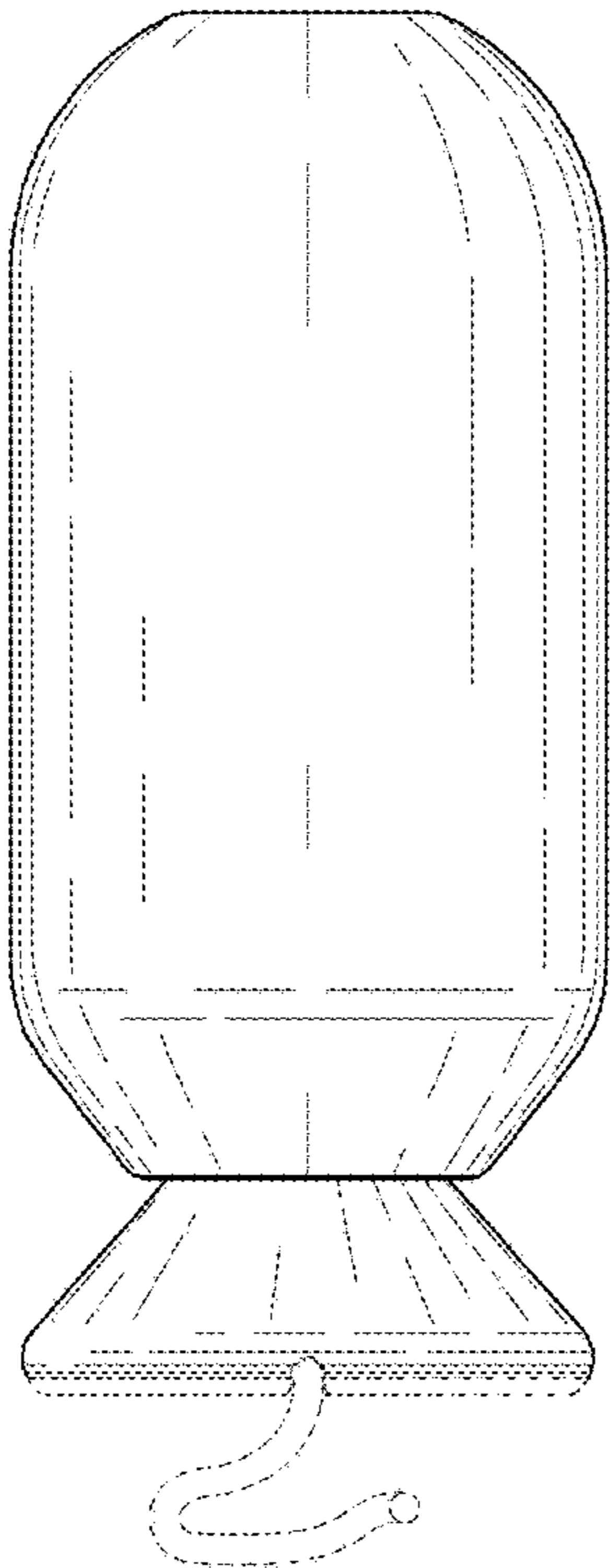

Fig. 6

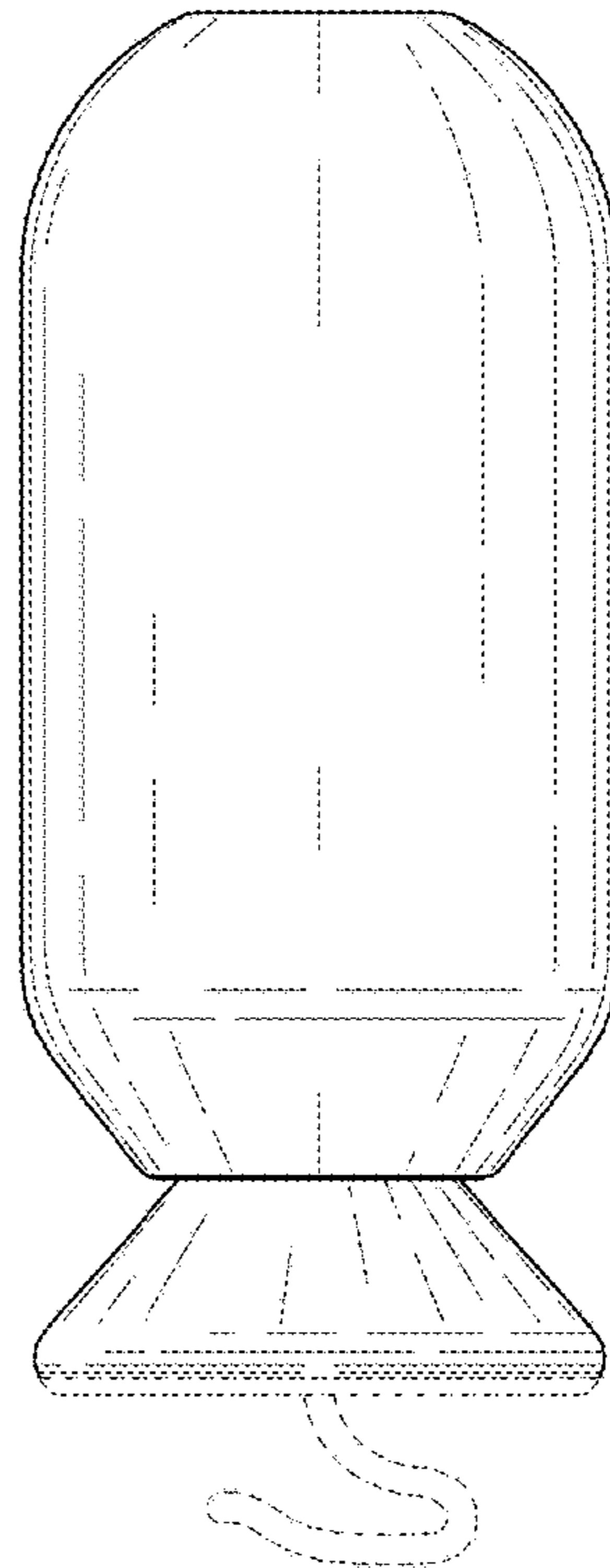

Fig. 7

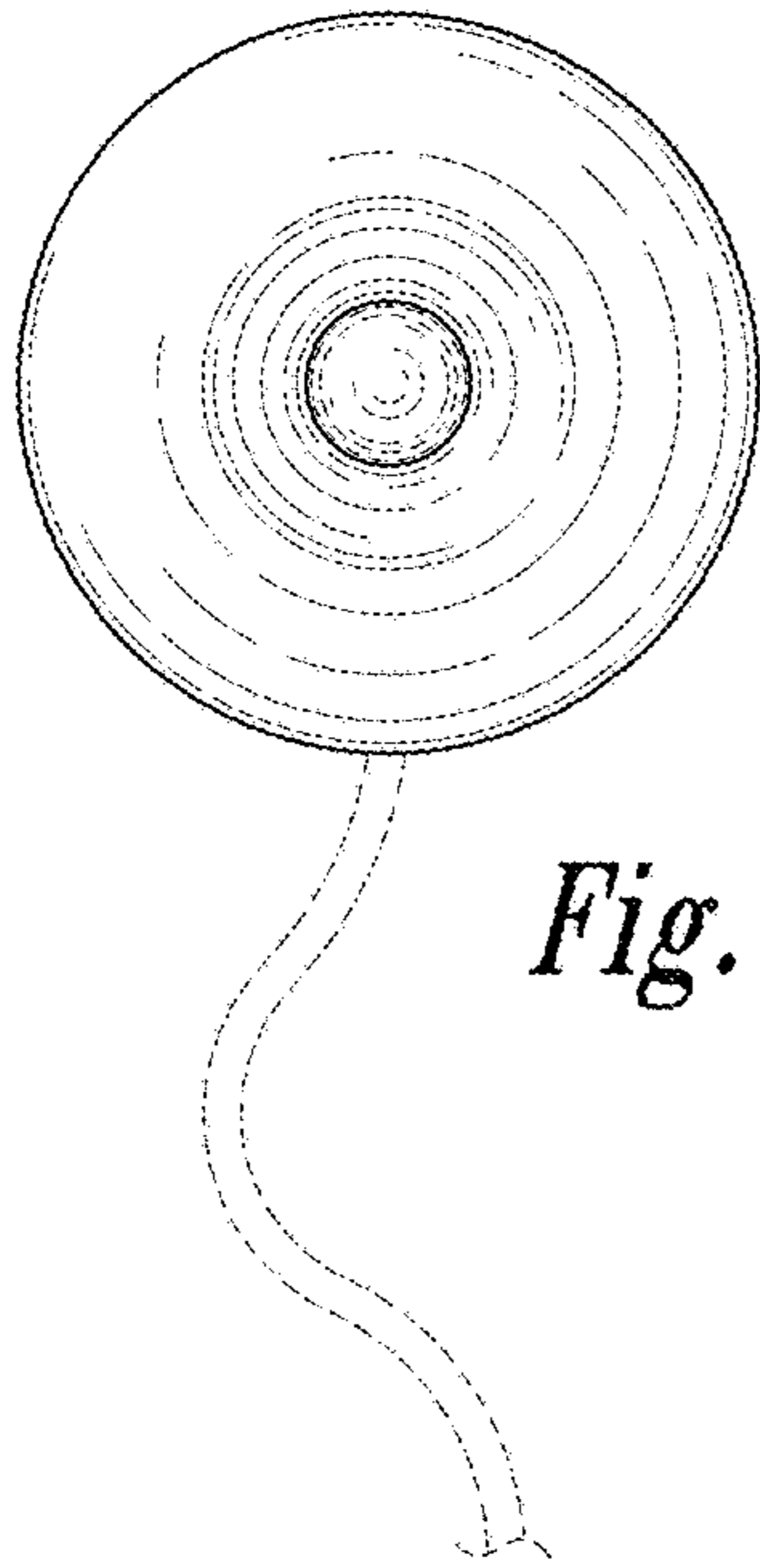

Fig. 8

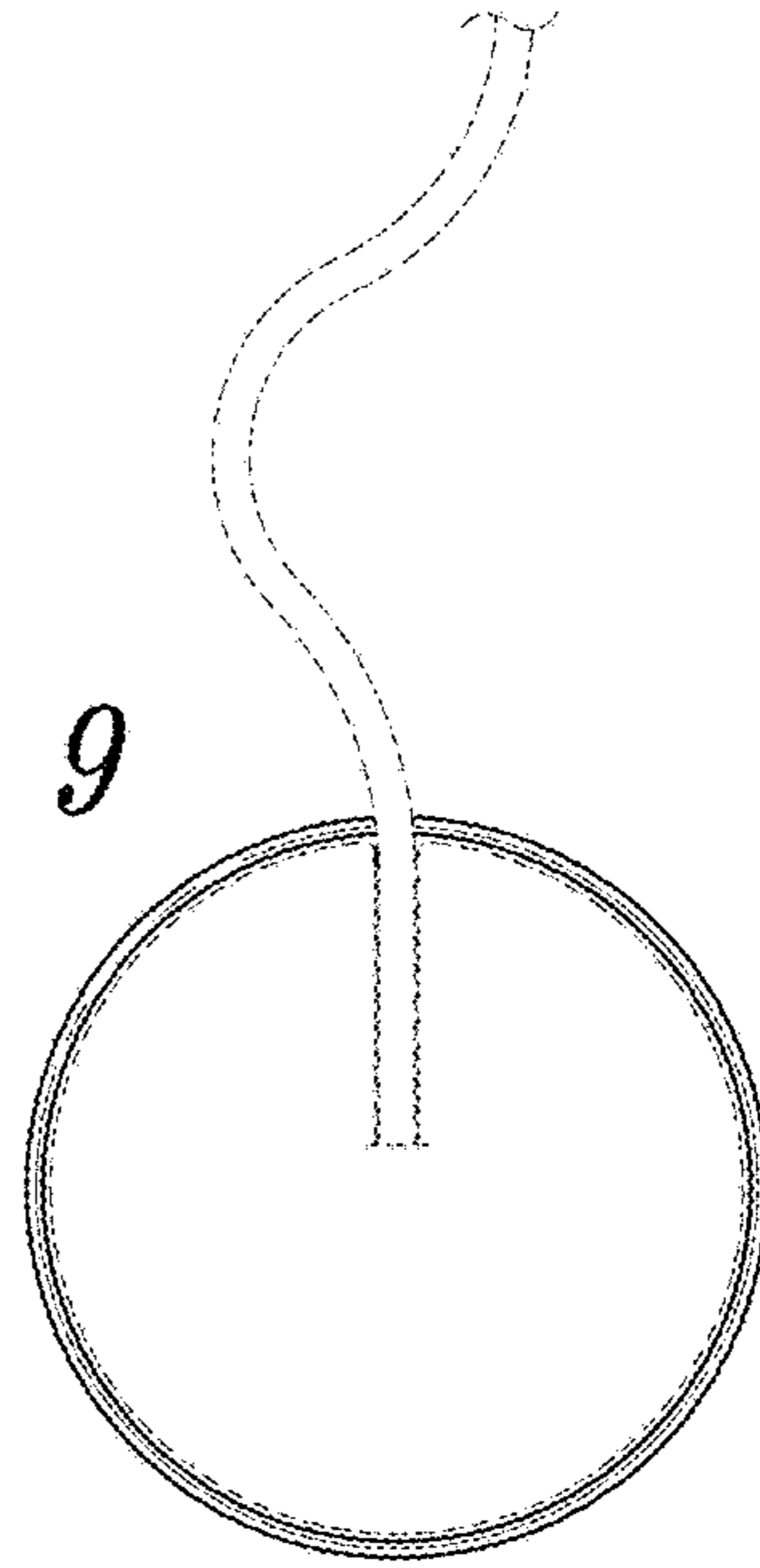

Fig. 9

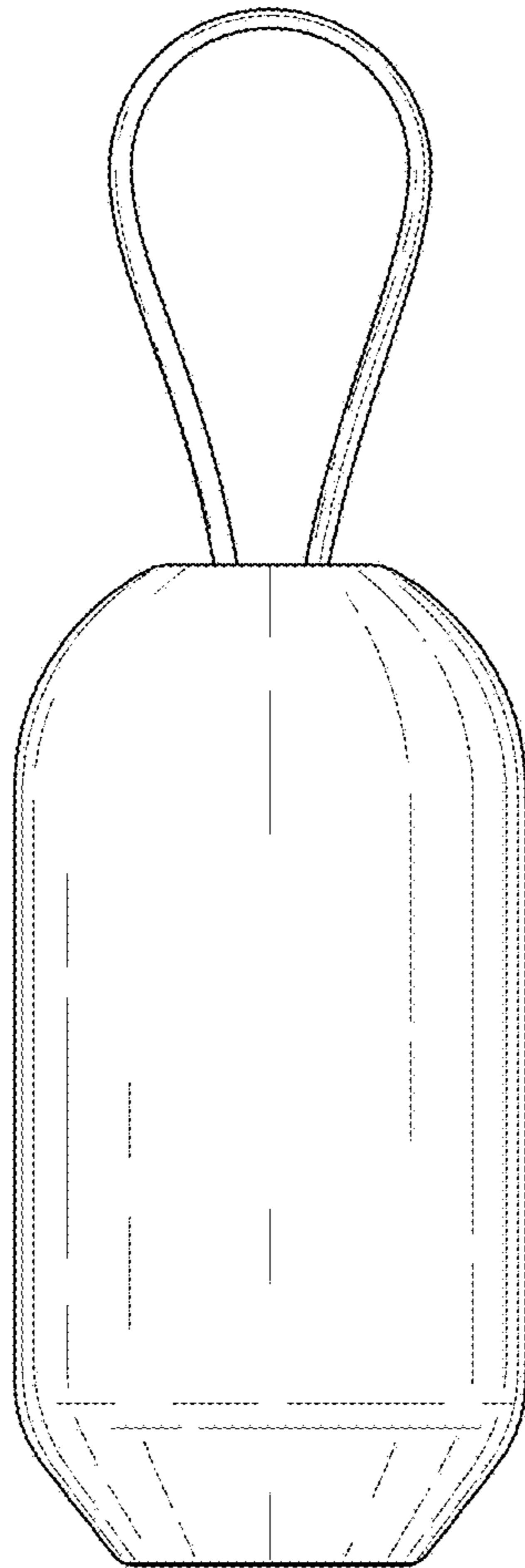

Fig. 10

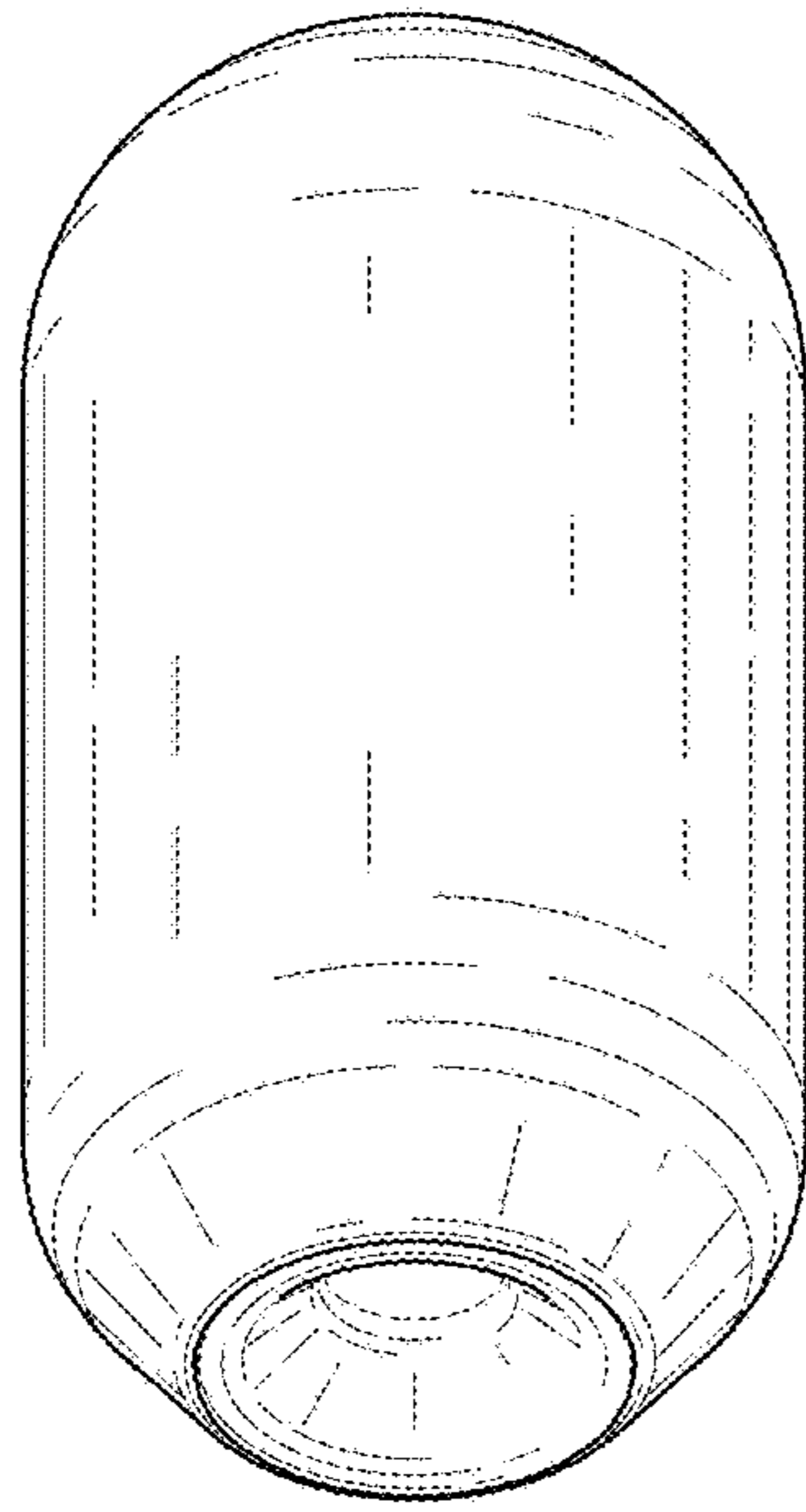

Fig. 11

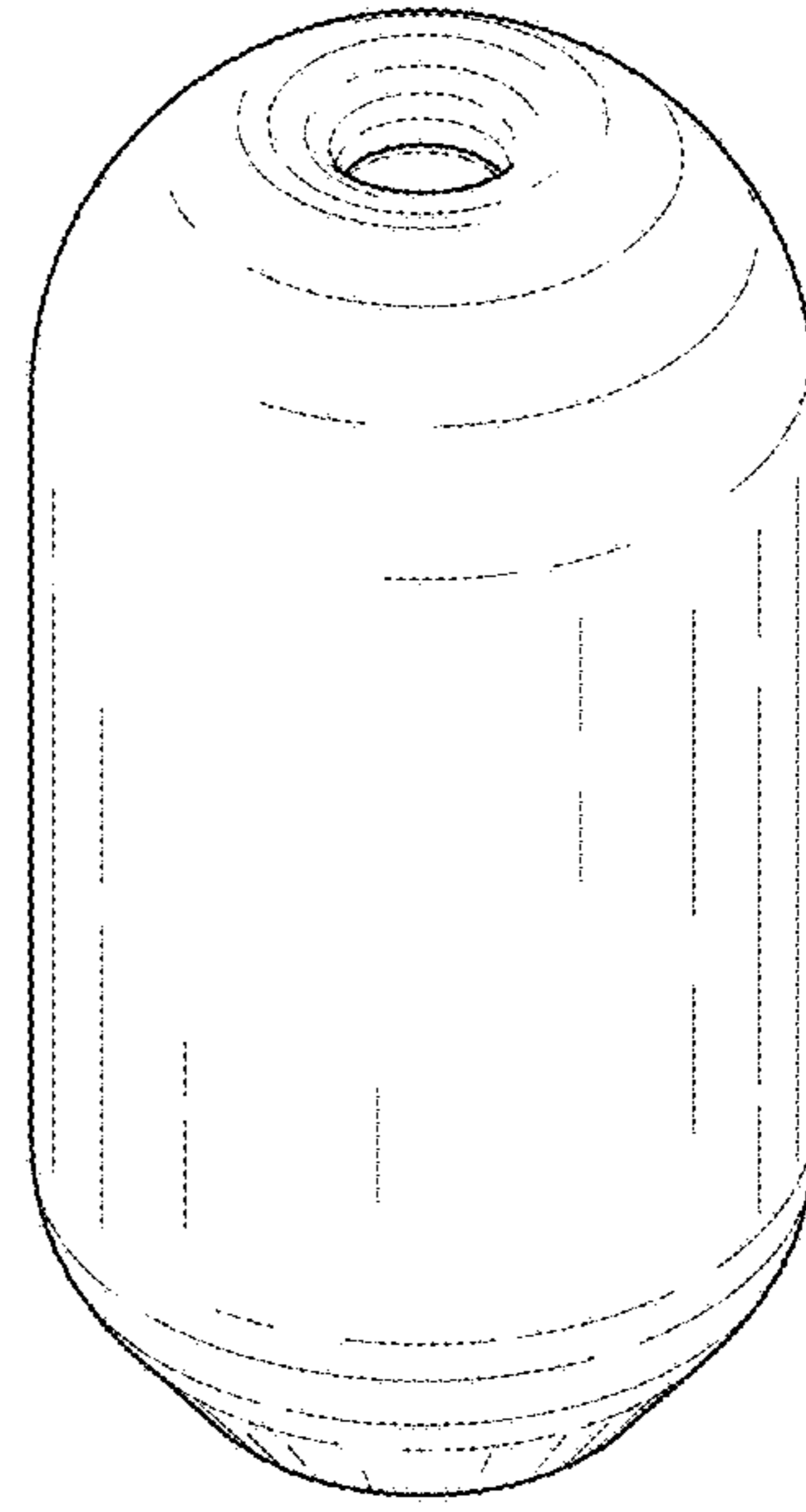

Fig. 12

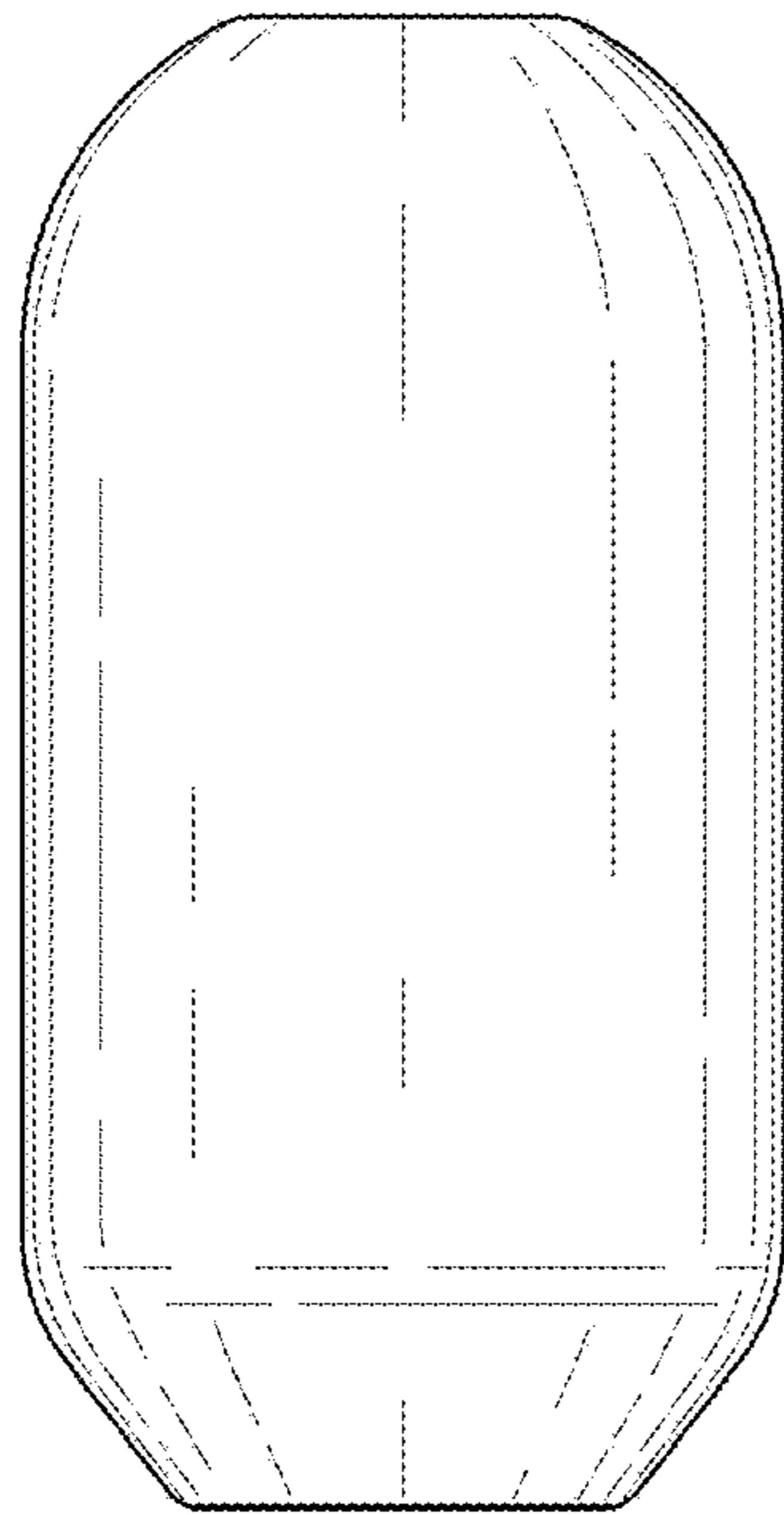

Fig. 13

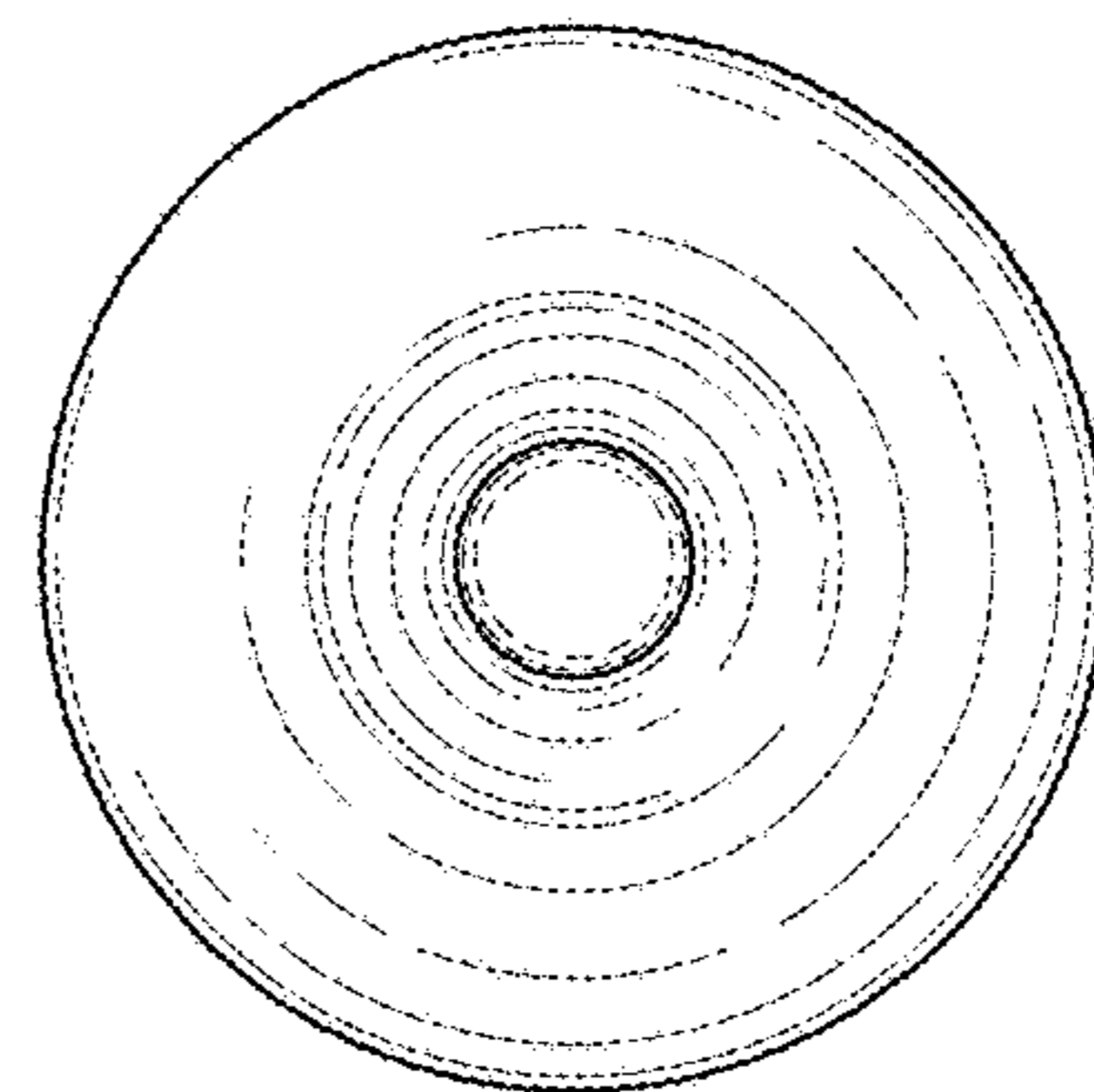

Fig. 14

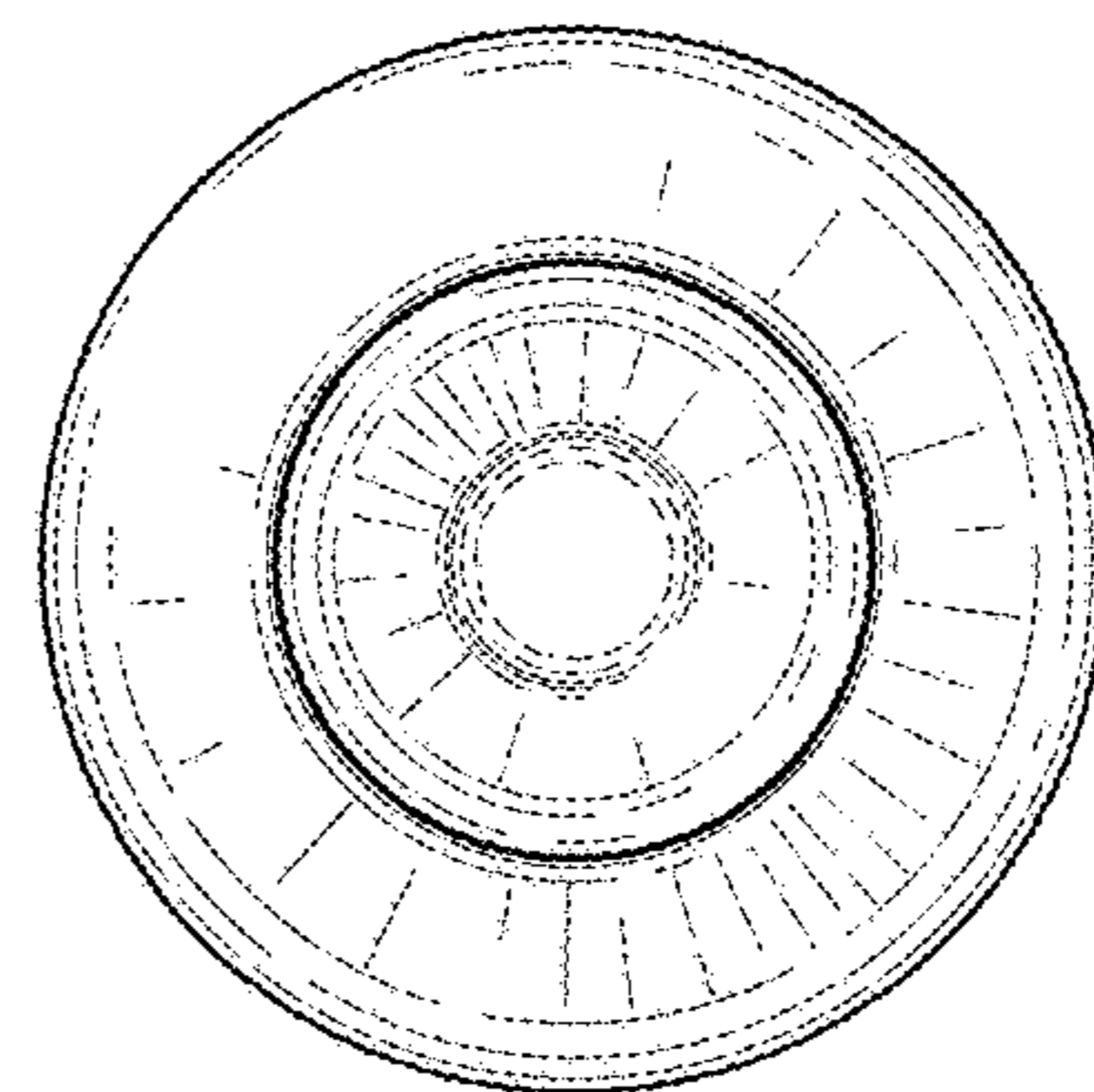

Fig. 15

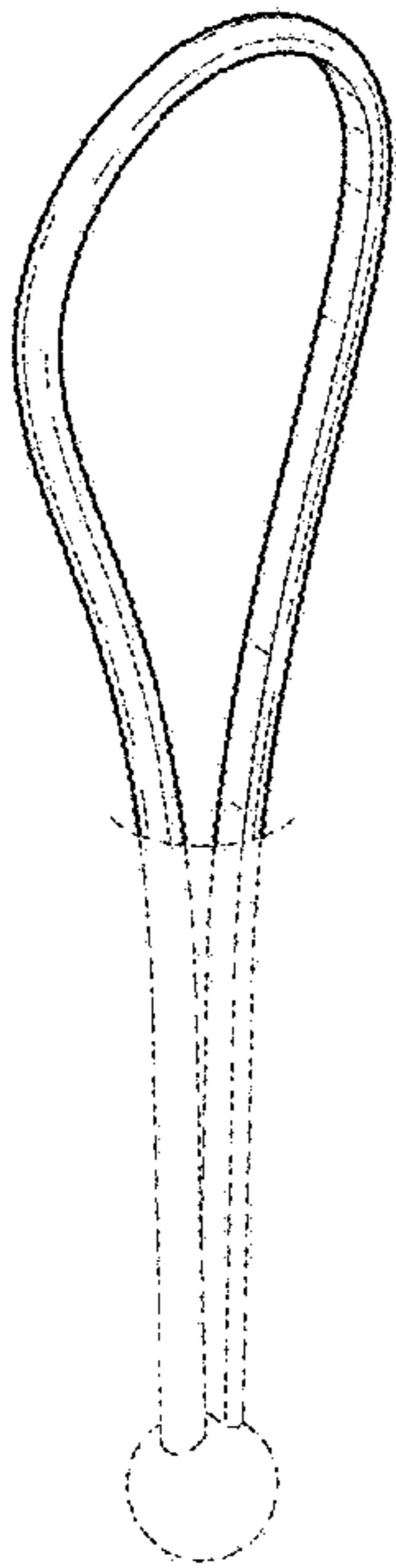

Fig. 16

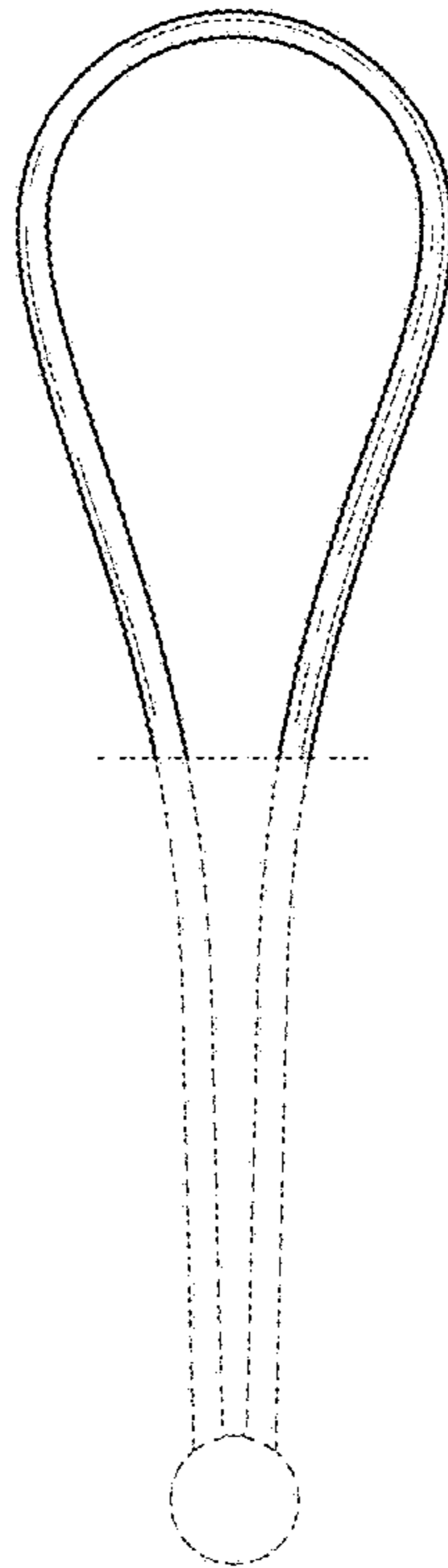

Fig. 17

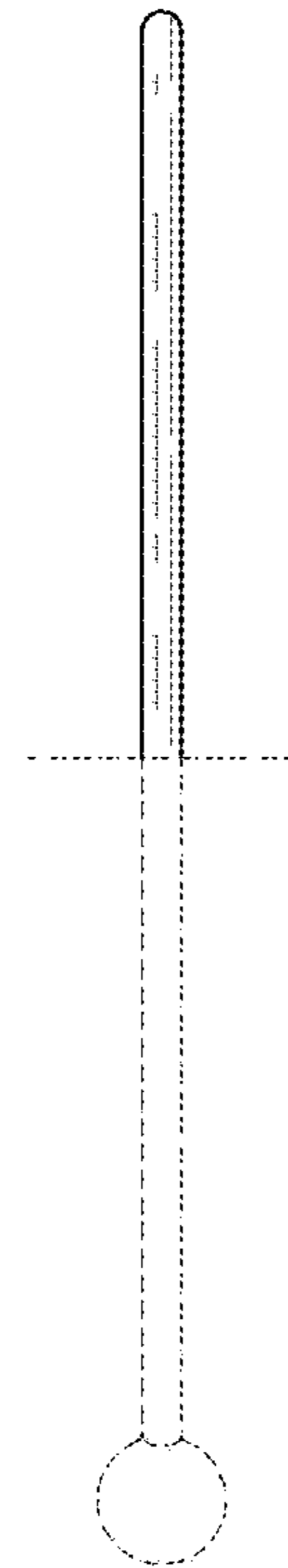

Fig. 18



Fig. 19

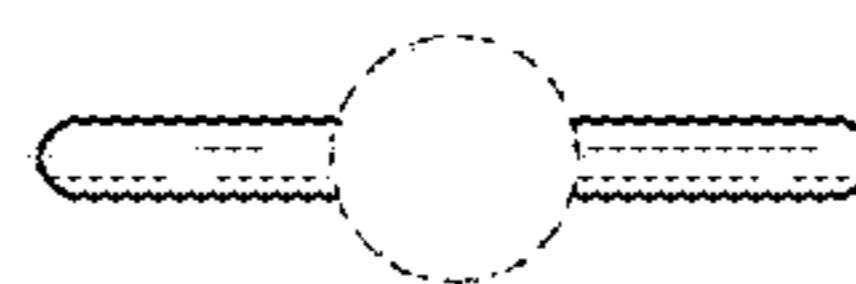

Fig. 20

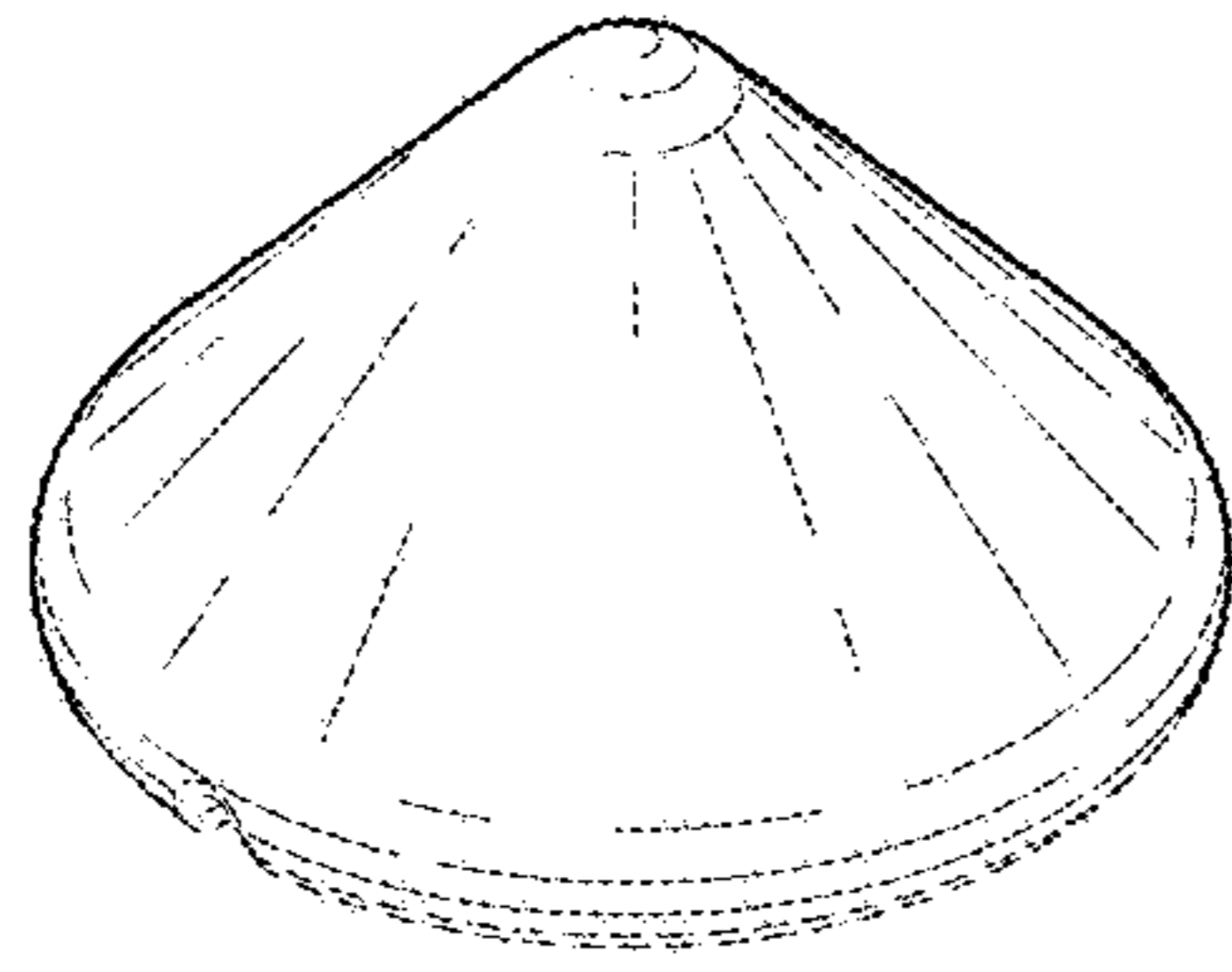

Fig. 21

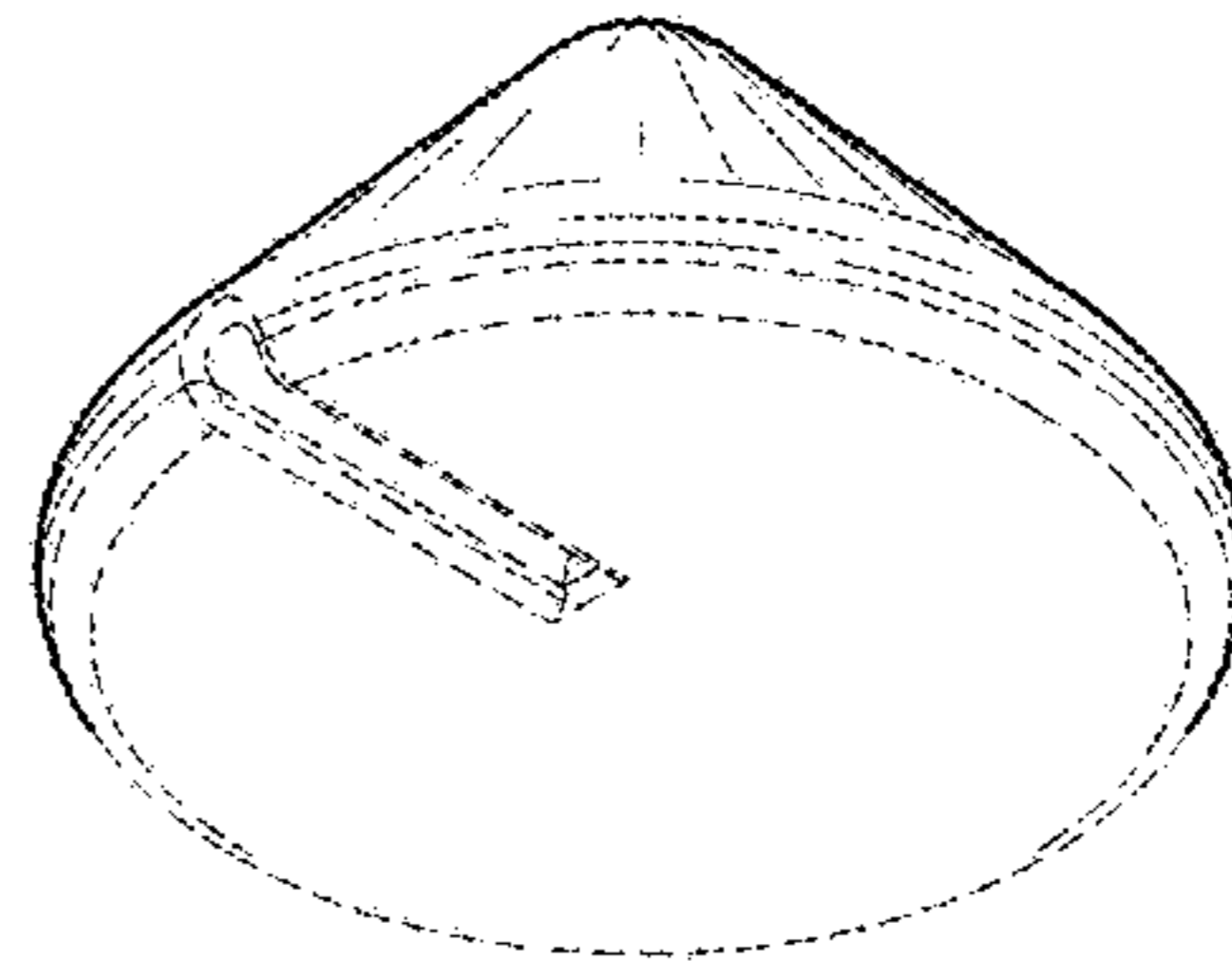

Fig. 22

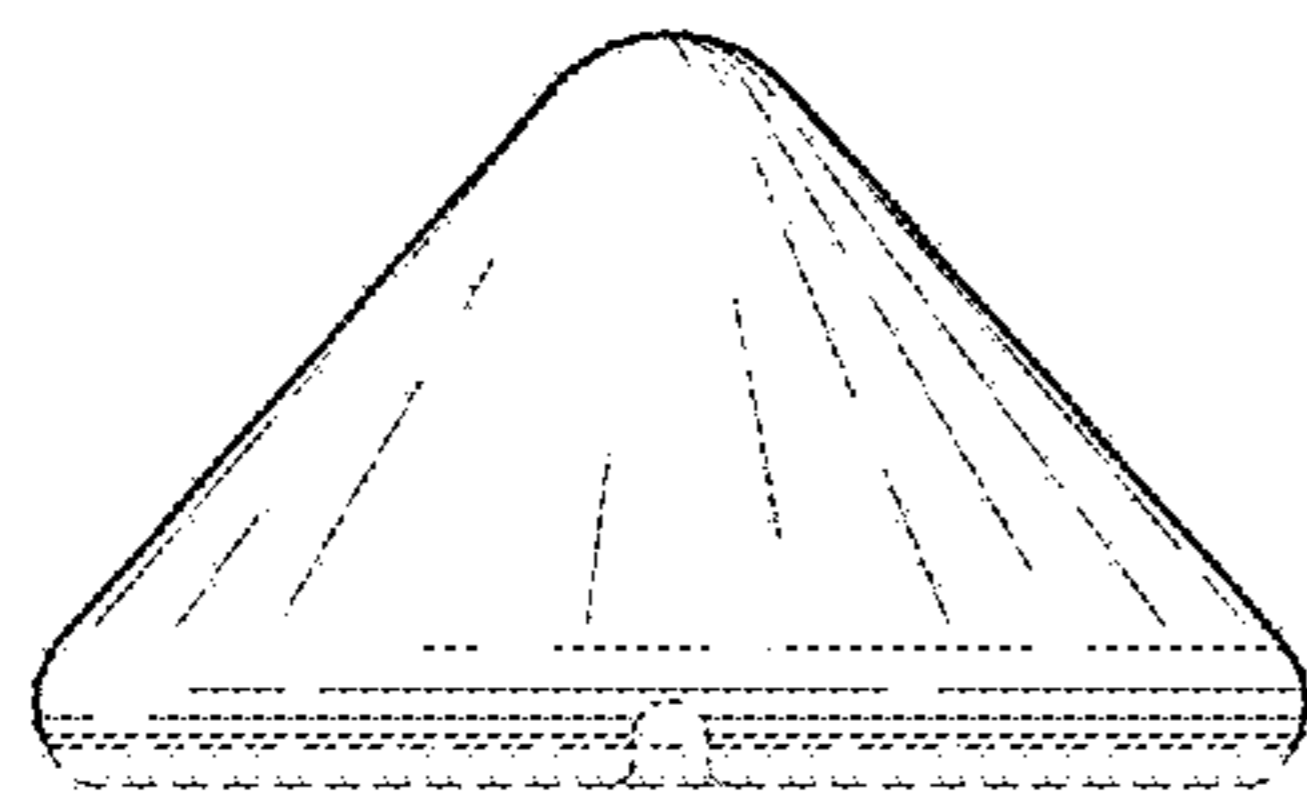

Fig. 23

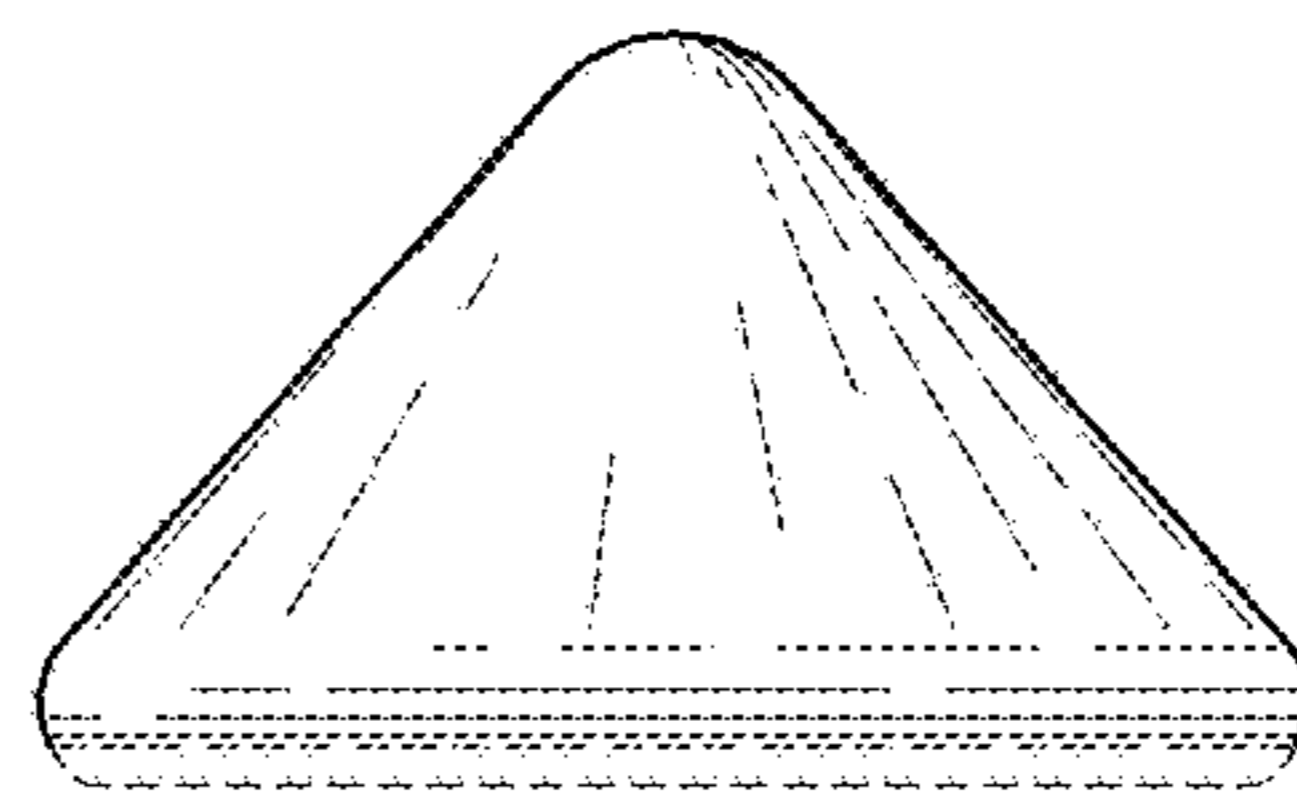

Fig. 24

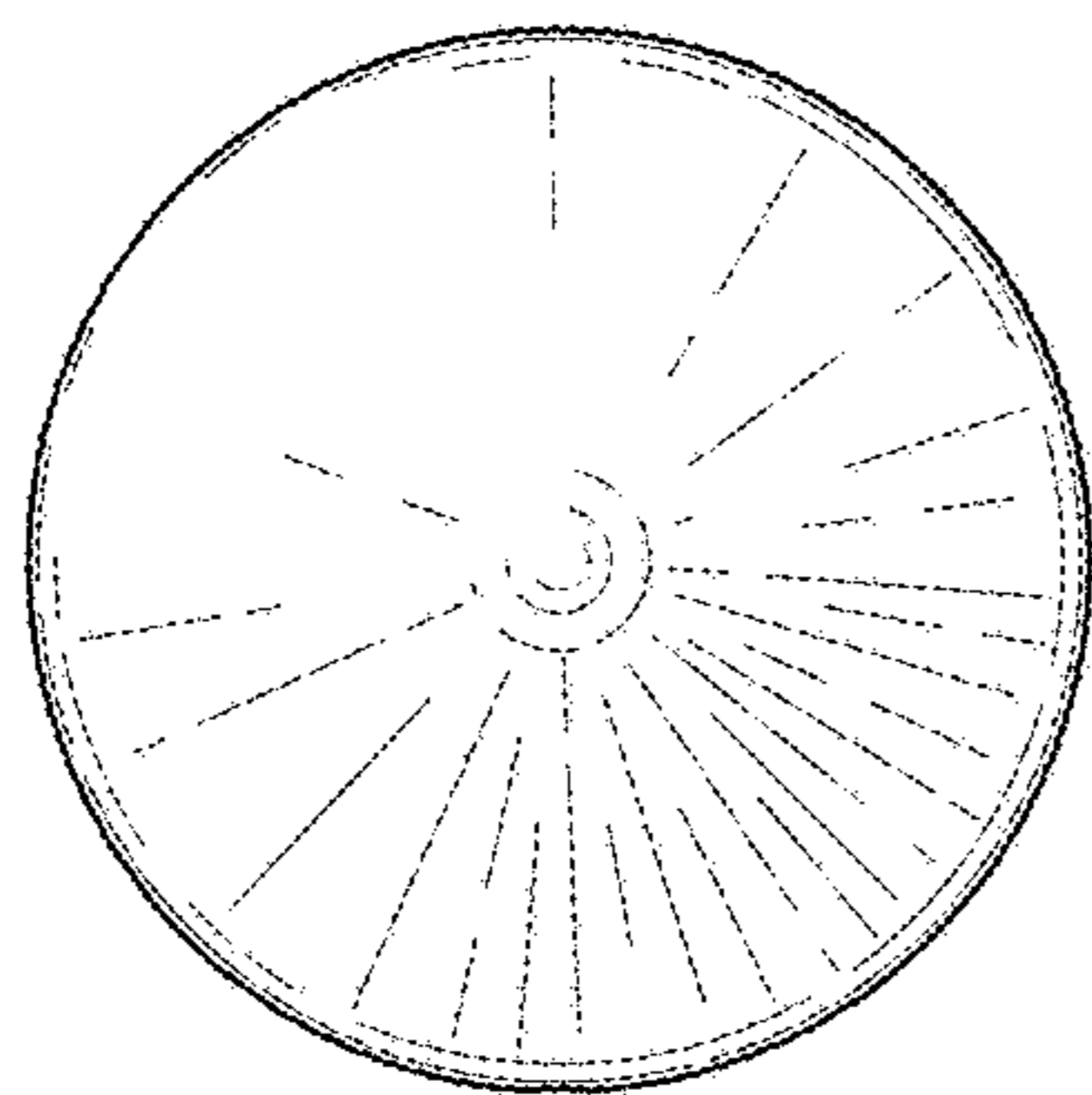

Fig. 25

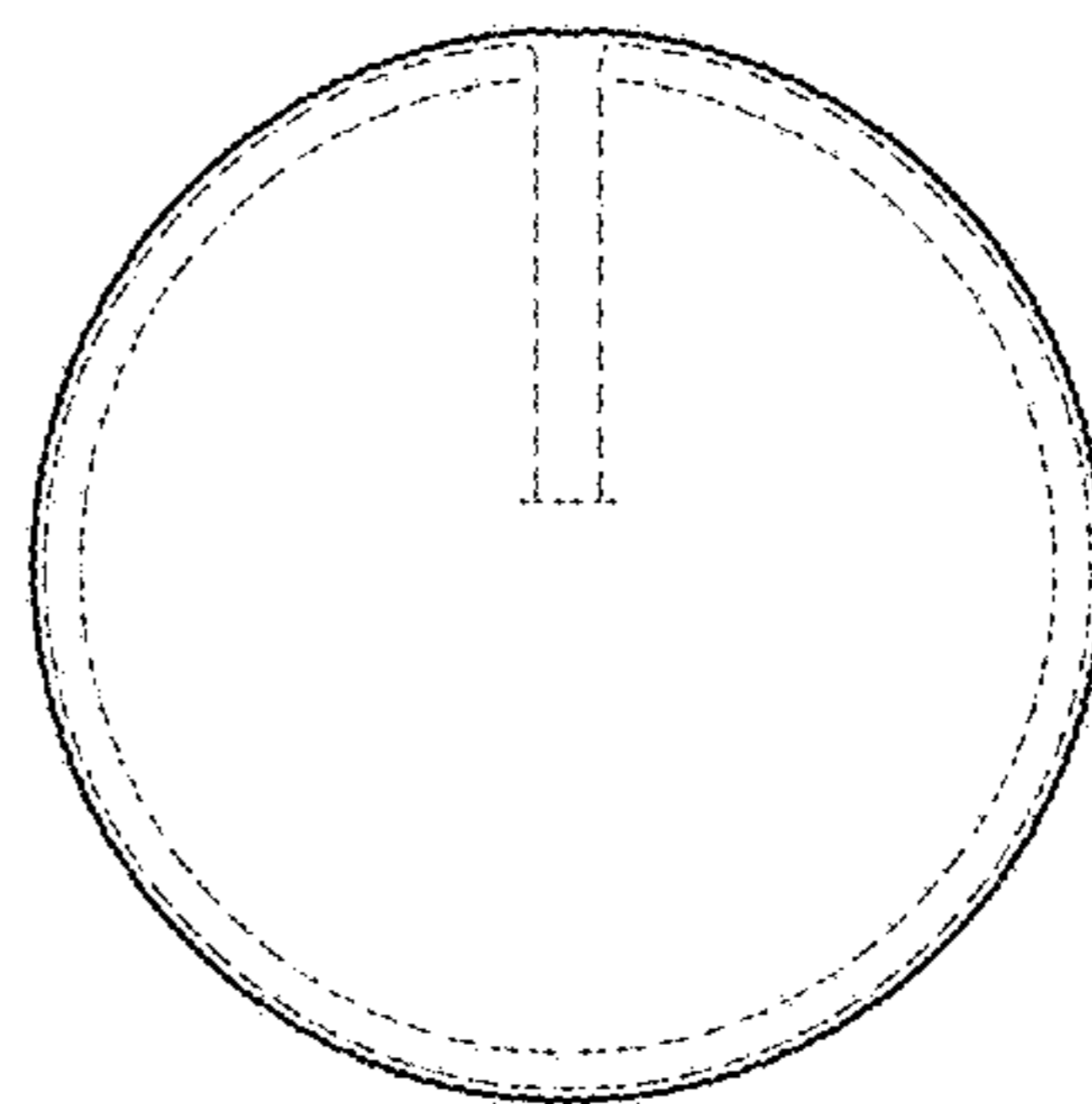

Fig. 26