



US00D814045S

(12) **United States Design Patent**
Kamees et al.

(10) **Patent No.:** **US D814,045 S**
(45) **Date of Patent:** **** Mar. 27, 2018**

(54) **LABORATORY DEVICE**

FOREIGN PATENT DOCUMENTS

(71) Applicant: **Heathrow Scientific LLC**, Vernon Hills, IL (US)

JP 2007237173 9/2007

(72) Inventors: **Gary Dean Kamees**, Gurnee, IL (US);
Rainer Joseph Wohlgemuth, Palatine, IL (US);
Alice Marie Jandrisits, Des Plaines, IL (US)

OTHER PUBLICATIONS

DNA Daigger's New Attractions, Life Science Edition 2001, www.daigger.com (2 pages).

(73) Assignee: **HEATHROW SCIENTIFIC LLC**, Vernon Hills, IL (US)

* cited by examiner

(**) Term: **15 Years**

Primary Examiner — Wan Laymon
Assistant Examiner — Mark Booker

(21) Appl. No.: **29/568,168**

(74) *Attorney, Agent, or Firm* — Michael Best & Friedrich LLP

(22) Filed: **Jun. 15, 2016**

(57) **CLAIM**

(51) **LOC (11) Cl.** **24-01**

We claim the ornamental design for a laboratory device, as shown and described.

(52) **U.S. Cl.**
USPC **D24/216**

DESCRIPTION

(58) **Field of Classification Search**
USPC D24/216, 186, 215, 217, 218, 219, 231,
D24/232; D10/81, 87
CPC G01N 9/30; G01N 15/042; G01N 33/491;
G01N 2035/00801; B04B 7/02
See application file for complete search history.

FIG. 1 is a perspective view of a laboratory device according to a first embodiment of the present invention.
FIG. 2 is a front view of the laboratory device of FIG. 1.
FIG. 3 is a rear view of the laboratory device of FIG. 1.
FIG. 4 is a left-side view of the laboratory device of FIG. 1.
FIG. 5 is a right-side view of the laboratory device of FIG. 1.
FIG. 6 is an enlarged top view of the laboratory device of FIG. 1; and,
FIG. 7 is an enlarged bottom view of the laboratory device of FIG. 1.
The broken line showing in the figures is included for the purpose of illustrating portions of the laboratory device and form no part of the claimed design.

(56) **References Cited**

U.S. PATENT DOCUMENTS

4,555,183	A	11/1985	Thomas	
D335,930	S *	5/1993	Tominaga	D24/219
D437,418	S *	2/2001	Suzuki	D24/219
7,654,729	B2	2/2010	Passoni	
8,550,696	B2	10/2013	Ebers et al.	
D706,945	S *	6/2014	Chan	D24/216
D752,769	S *	3/2016	Taniguchi	D24/219

1 Claim, 7 Drawing Sheets

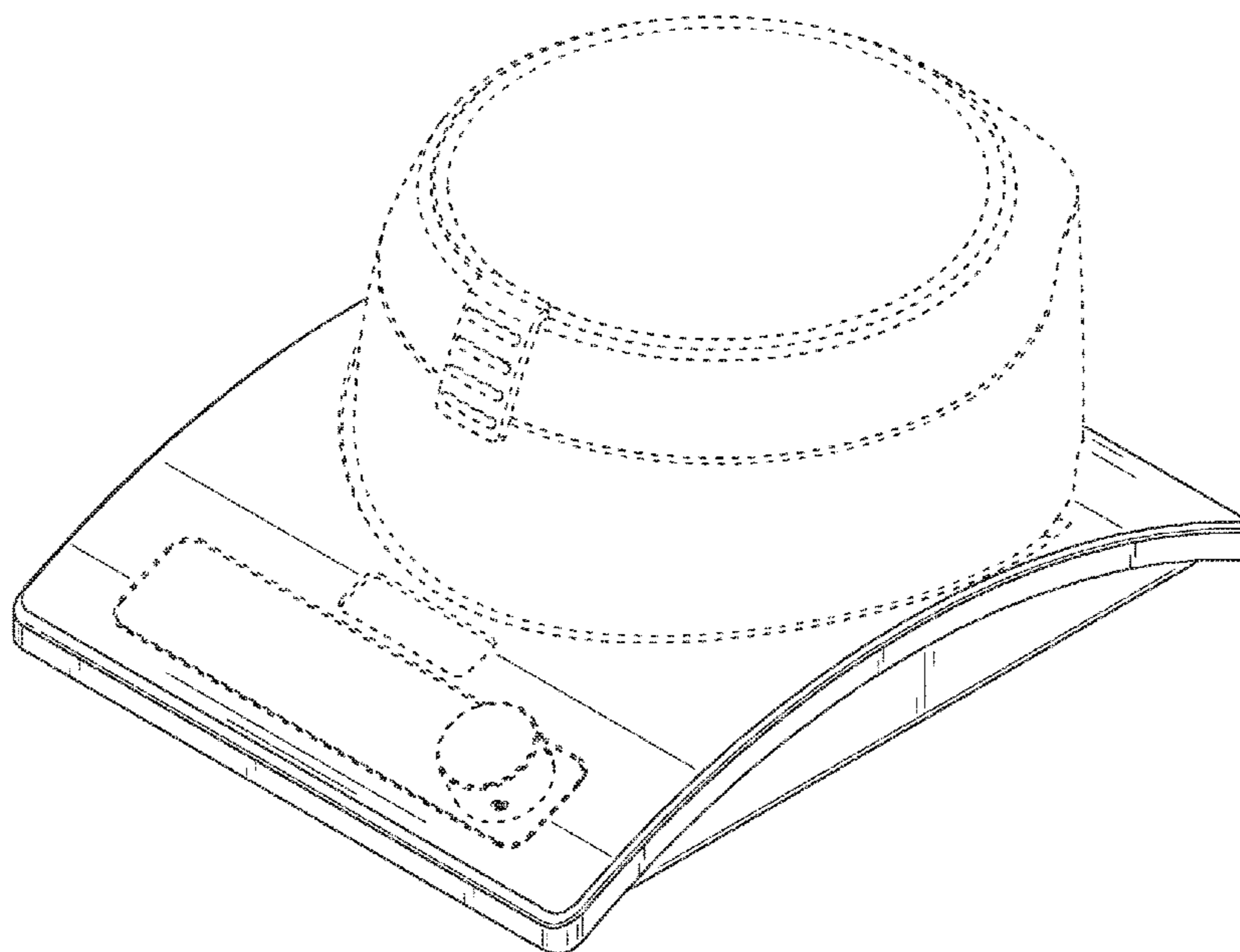

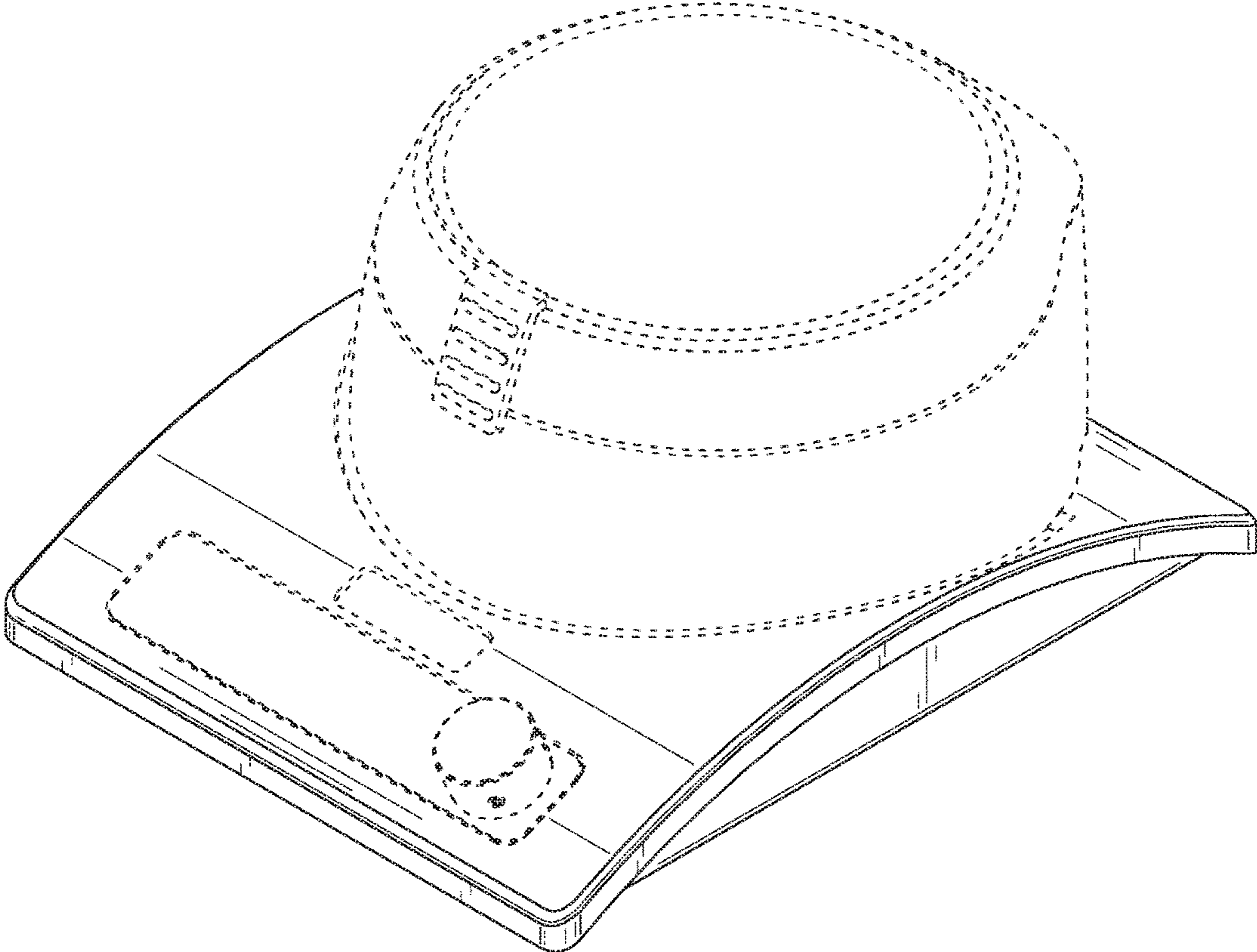

FIG. 1

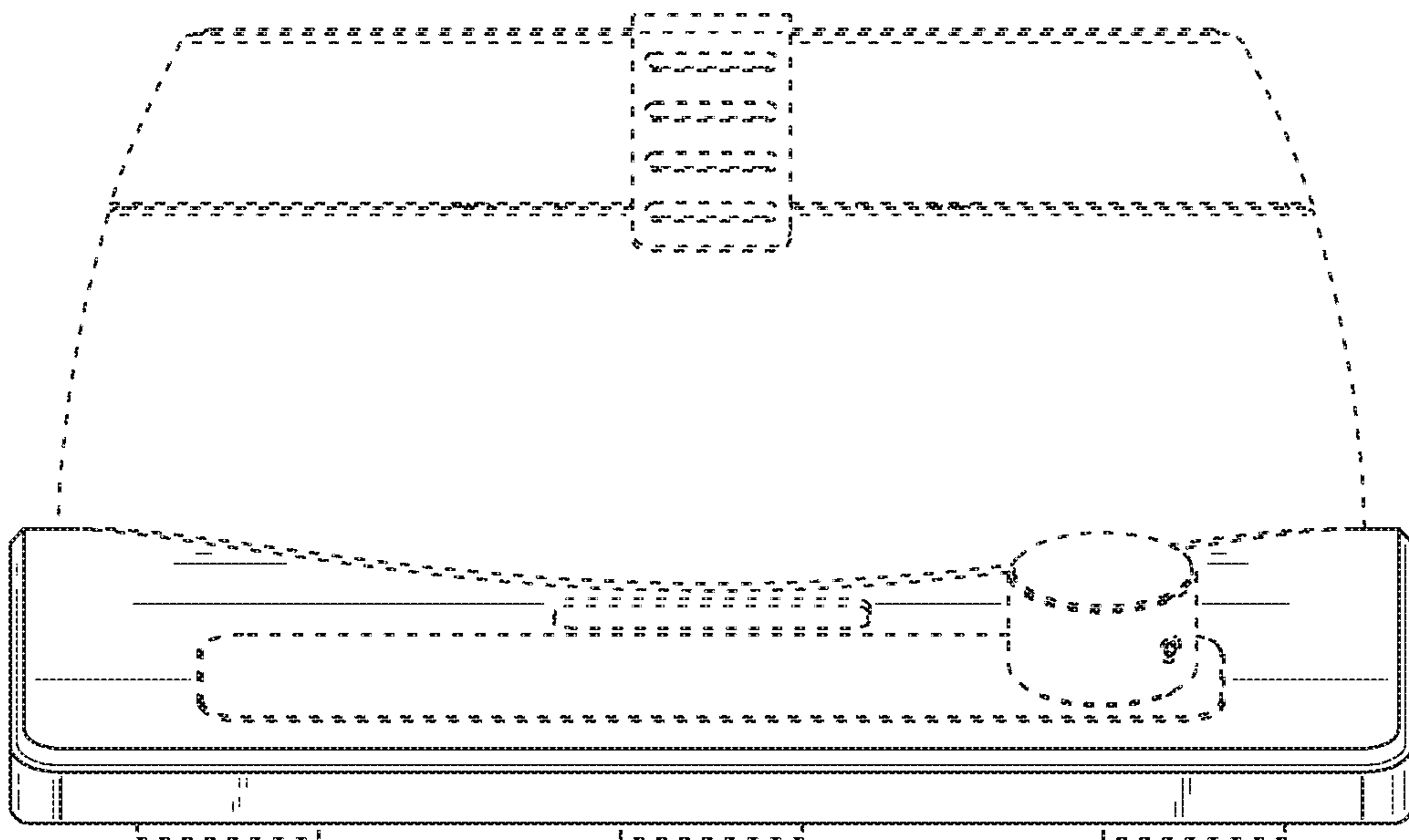

FIG. 2

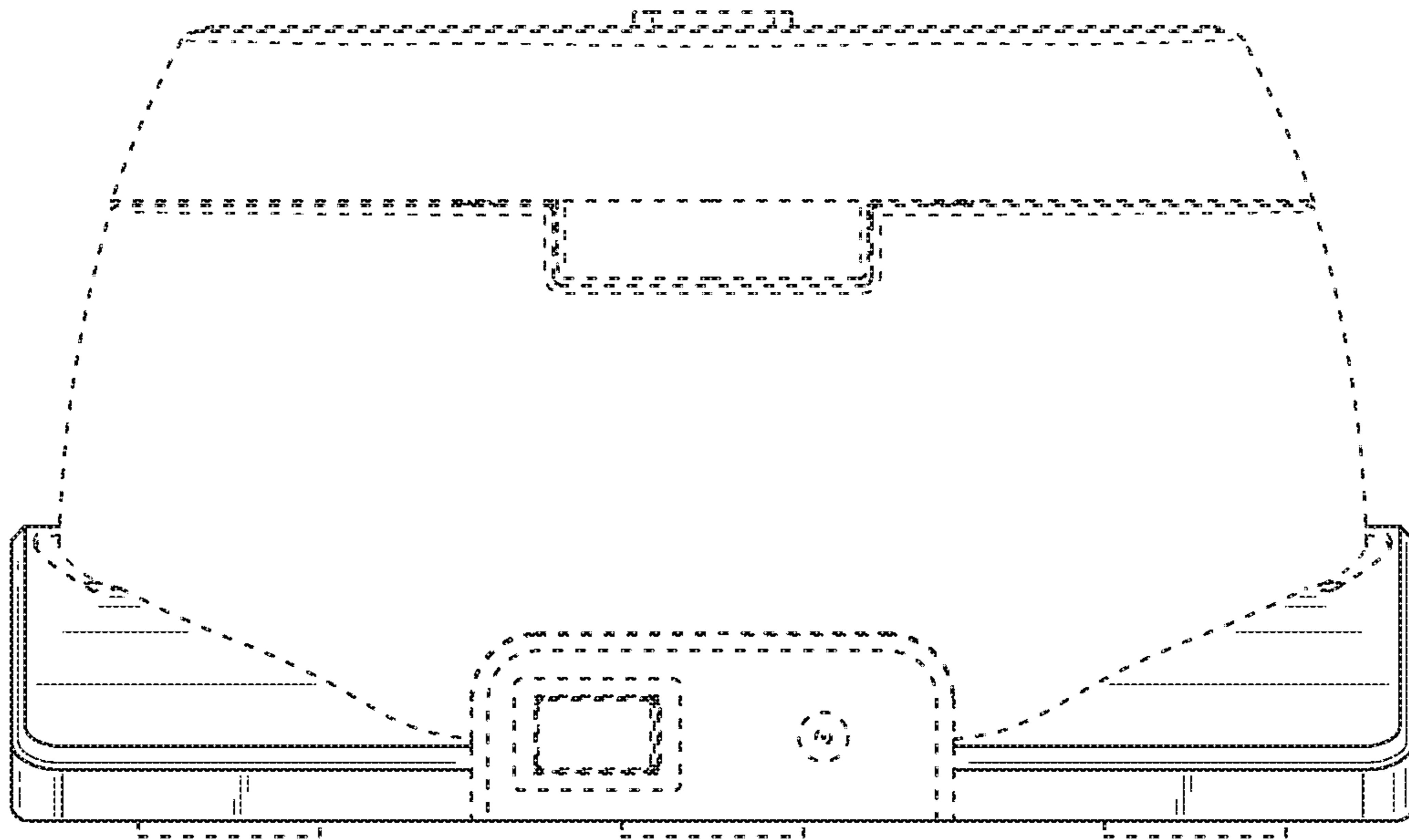

FIG. 3

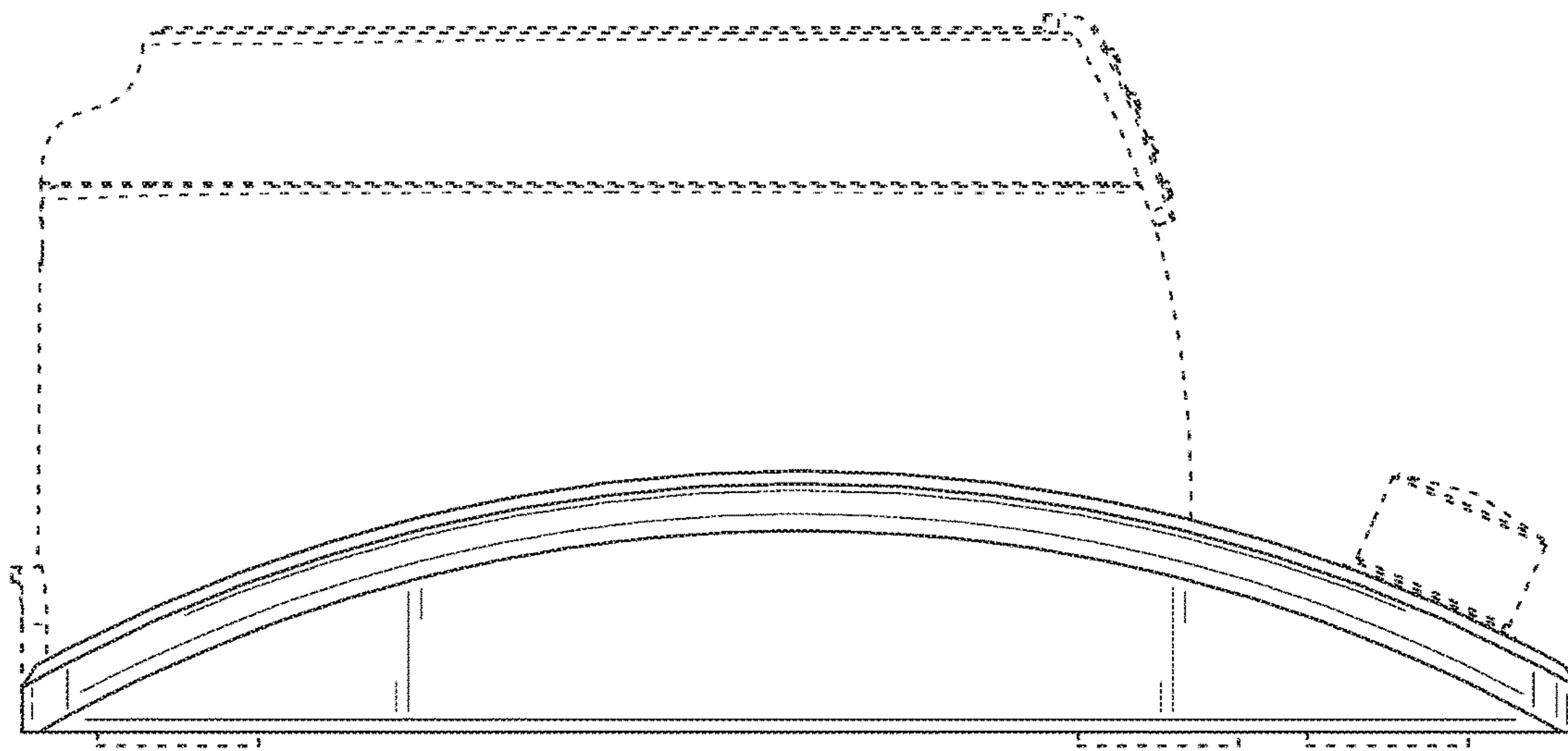

FIG. 4

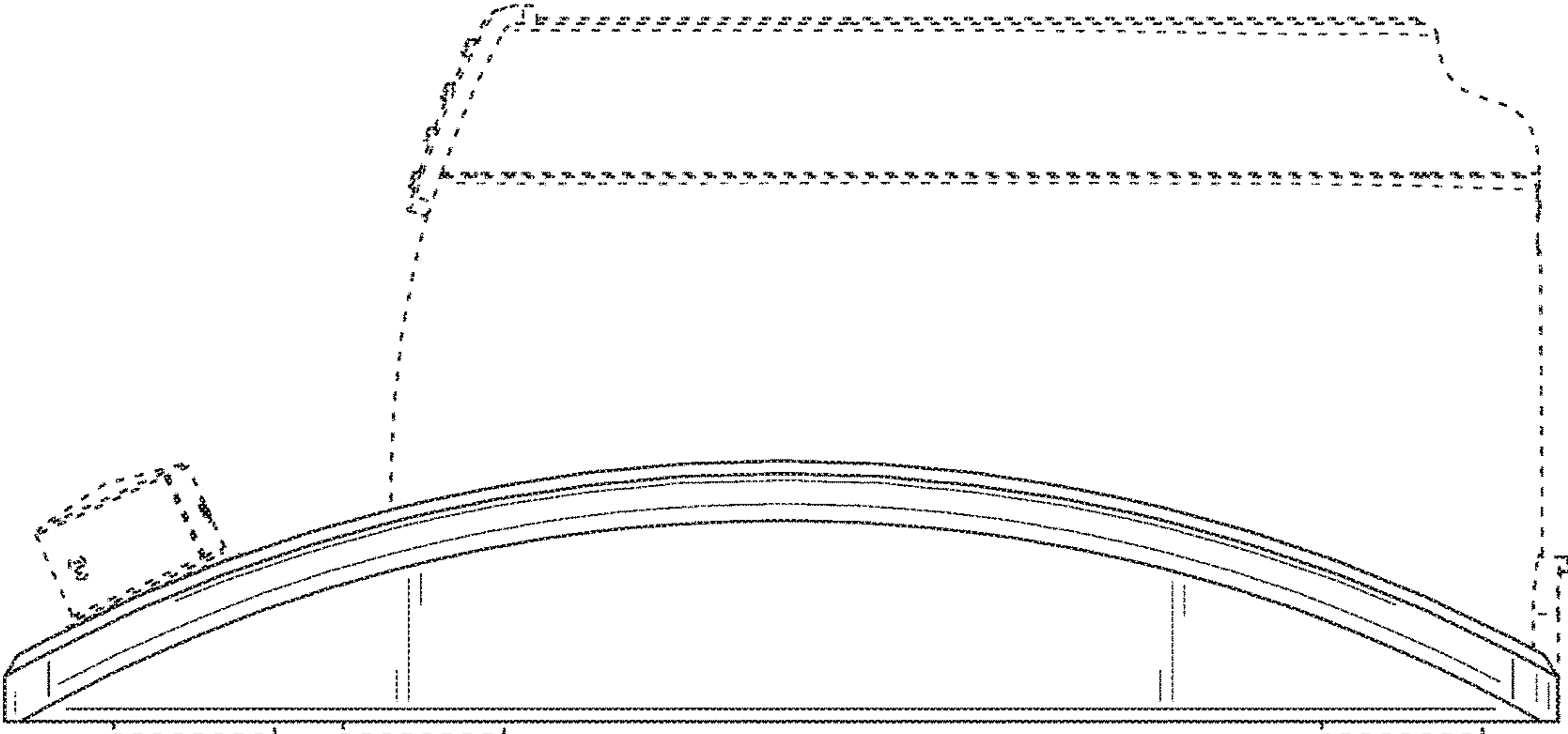

FIG. 5

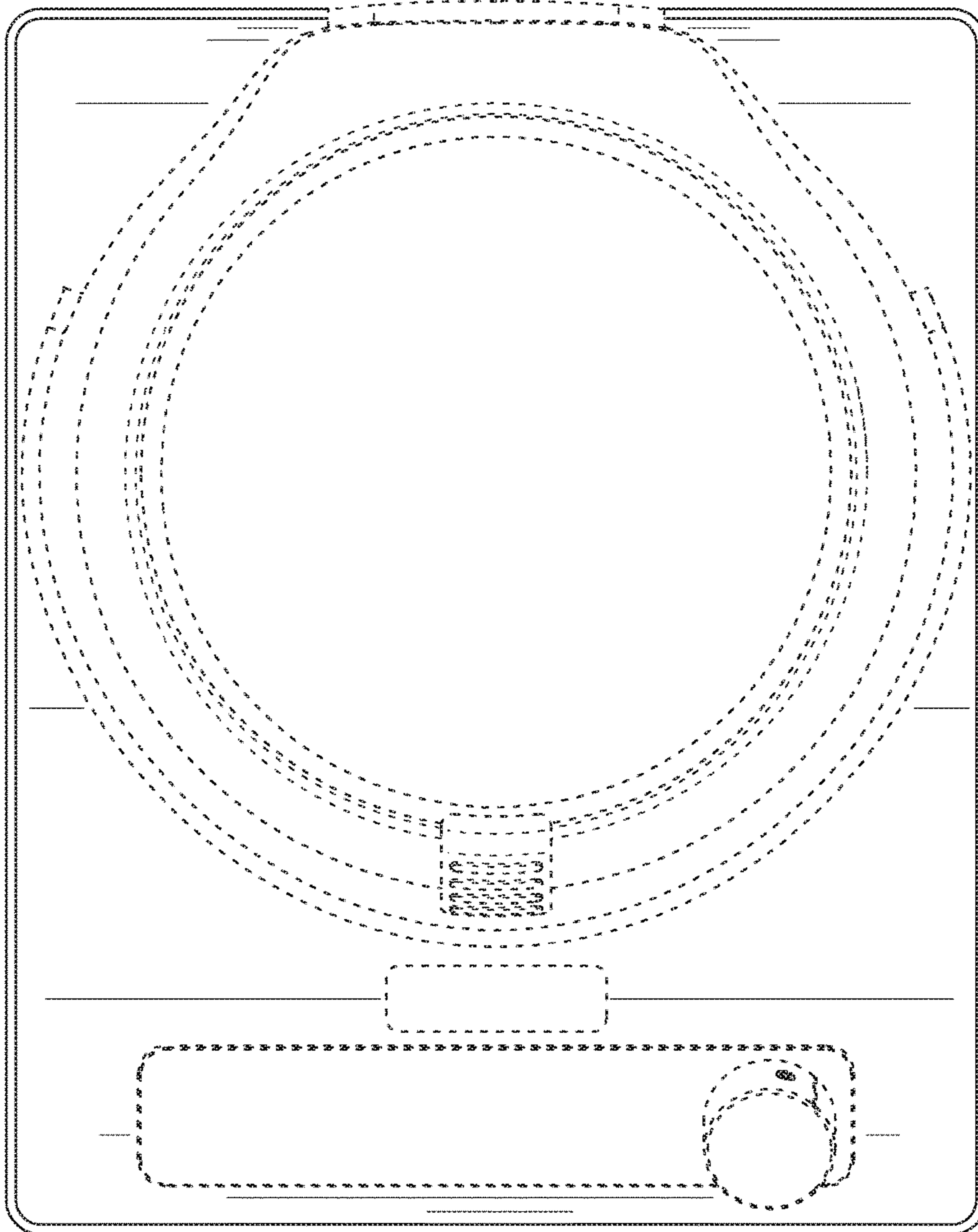

FIG. 6

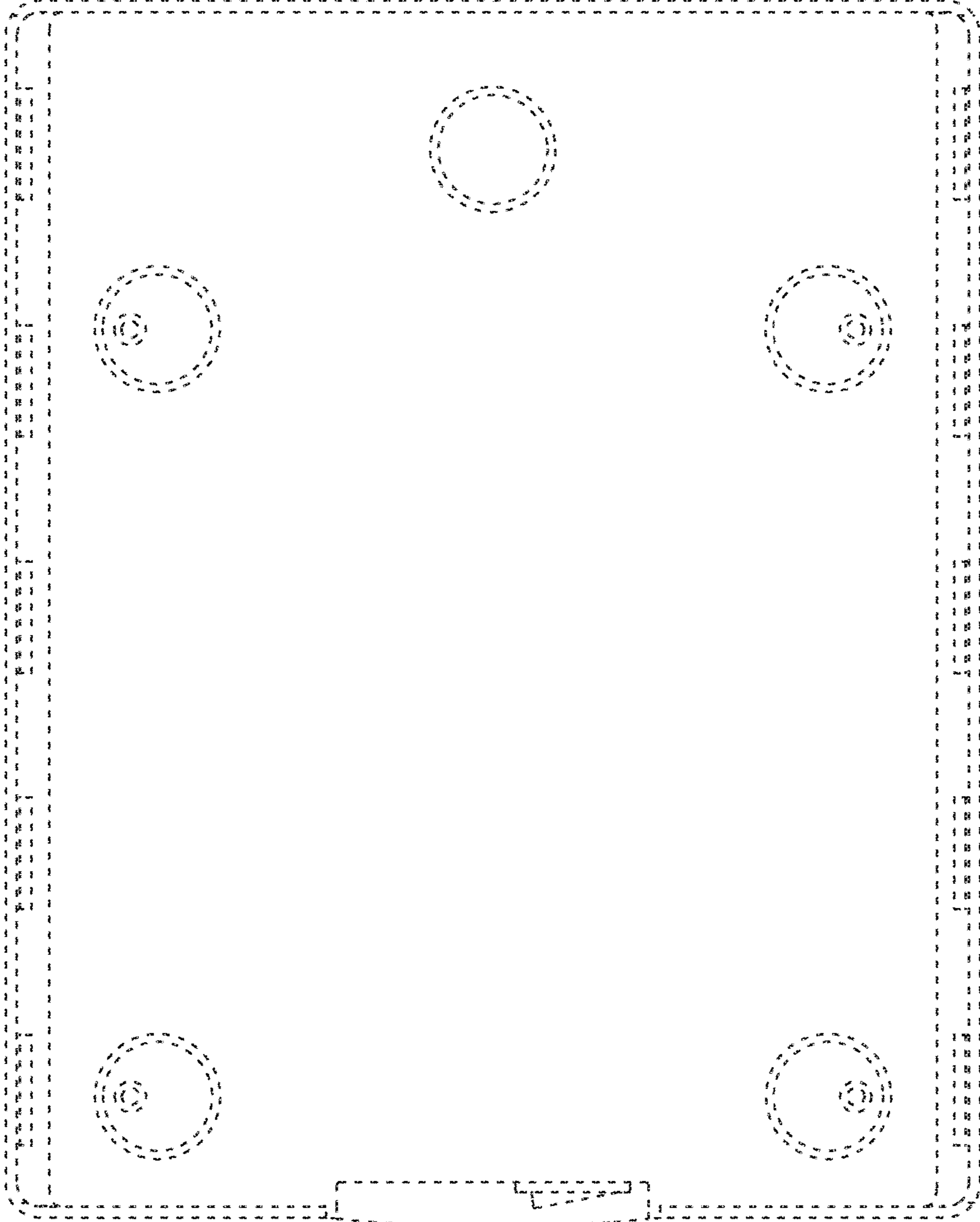

FIG. 7