



US00D814029S

(12) **United States Design Patent** (10) **Patent No.:** **US D814,029 S**
Ierulli (45) **Date of Patent:** **** Mar. 27, 2018**

(54) **NASAL DILATOR**

- (71) Applicant: **Joseph V. Ierulli**, Bradenton, FL (US)
- (72) Inventor: **Joseph V. Ierulli**, Bradenton, FL (US)
- (73) Assignee: **Corbett Lair Inc.**, Bradenton, FL (US)
- (**) Term: **15 Years**
- (21) Appl. No.: **29/603,526**
- (22) Filed: **May 10, 2017**

Related U.S. Application Data

- (60) Continuation of application No. 29/562,930, filed on Apr. 29, 2016, now Pat. No. Des. 791,314, which is a continuation of application No. 29/542,489, filed on Oct. 14, 2015, now Pat. No. Des. 759,241, which is a continuation of application No. 29/494,562, filed on Jun. 22, 2014, now Pat. No. Des. 743,545, which is a continuation of application No. 29/475,207, filed on Dec. 1, 2013, now Pat. No. Des. 741,997, which is a continuation of application No. 29/433,556, filed on Oct. 1, 2012, now Pat. No. Des. 707,814, which is a continuation of application No. 29/420,787, filed on May 13, 2012, now Pat. No. Des. 671,643, which is a continuation of application No. 29/399,247, filed on Aug. 11, 2011, now Pat. No. Des. 667,543, which is a division of application No. 29/380,763, filed on Dec. 10, 2010, now Pat. No. Des. 659,245, which is a continuation-in-part of application No. 12/106,289, filed on Apr. 19, 2008, now Pat. No. 8,062,329.
- (51) **LOC (11) Cl.** **24-02**
- (52) **U.S. Cl.**
USPC **D24/135**
- (58) **Field of Classification Search**
USPC D24/133, 135, 136, 189
CPC A61F 5/08; A61B 17/0057; A61B 1/233;
A61M 29/00; A61M 29/02
See application file for complete search history.

(56)

References Cited

U.S. PATENT DOCUMENTS

5,476,091 A	12/1995	Johnson	
5,479,944 A	1/1996	Petruson	
5,533,499 A	7/1996	Johnson	
5,533,503 A	7/1996	Doubek et al.	
5,546,929 A	8/1996	Muchin	
5,549,103 A	8/1996	Johnson	
RE35,408 E	12/1996	Petruson	
5,611,333 A	3/1997	Johnson	
5,653,224 A	8/1997	Johnson	
5,706,800 A	1/1998	Cronk et al.	
5,718,224 A	2/1998	Muchin	
5,769,089 A	6/1998	Hand et al.	
5,842,469 A *	12/1998	Rapp	A61F 5/08 128/200.24
5,890,486 A	4/1999	Mitra et al.	
5,931,854 A	8/1999	Dillon	
5,957,126 A	9/1999	Neeser	
6,006,746 A	12/1999	Karell	
6,029,658 A	2/2000	De Voss	
6,058,931 A	5/2000	Muchin	
6,065,470 A	5/2000	Van Cromvoirt et al.	
6,098,616 A	8/2000	Lundy et al.	
6,196,228 B1	3/2001	Kreitzer et al.	
6,244,265 B1	6/2001	Cronk et al.	
6,276,360 B1	8/2001	Cronk et al.	
6,318,362 B1	11/2001	Johnson	
6,357,436 B1	3/2002	Kreitzer et al.	
6,375,667 B1	4/2002	Ruch	
6,453,901 B1	9/2002	Ierulli	
6,470,883 B1	10/2002	Beaudry	
6,550,474 B1	4/2003	Anderson et al.	
6,694,970 B2	2/2004	Spinelli et al.	
6,769,428 B2	8/2004	Cronk et al.	
6,769,429 B1	8/2004	Benetti	
7,067,710 B1	6/2006	Beaudry	
7,114,495 B2	10/2006	Lockwood, Jr.	
D639,762 S	6/2011	Brogden et al.	
D644,325 S	8/2011	Brunner et al.	
D644,324 S	10/2011	Brunner et al.	
8,047,201 B2	11/2011	Guyuron et al.	
8,062,329 B2	11/2011	Ierulli	
D651,710 S	1/2012	Brogden et al.	
8,115,049 B2	2/2012	Beaudry	
D659,245 S	5/2012	Ierulli	
8,188,330 B2	5/2012	Beaudry	
D662,203 S	6/2012	Smith	
D667,543 S	9/2012	Ierulli	
D671,643 S	11/2012	Ierulli	
D672,461 S	12/2012	Brogden et al.	

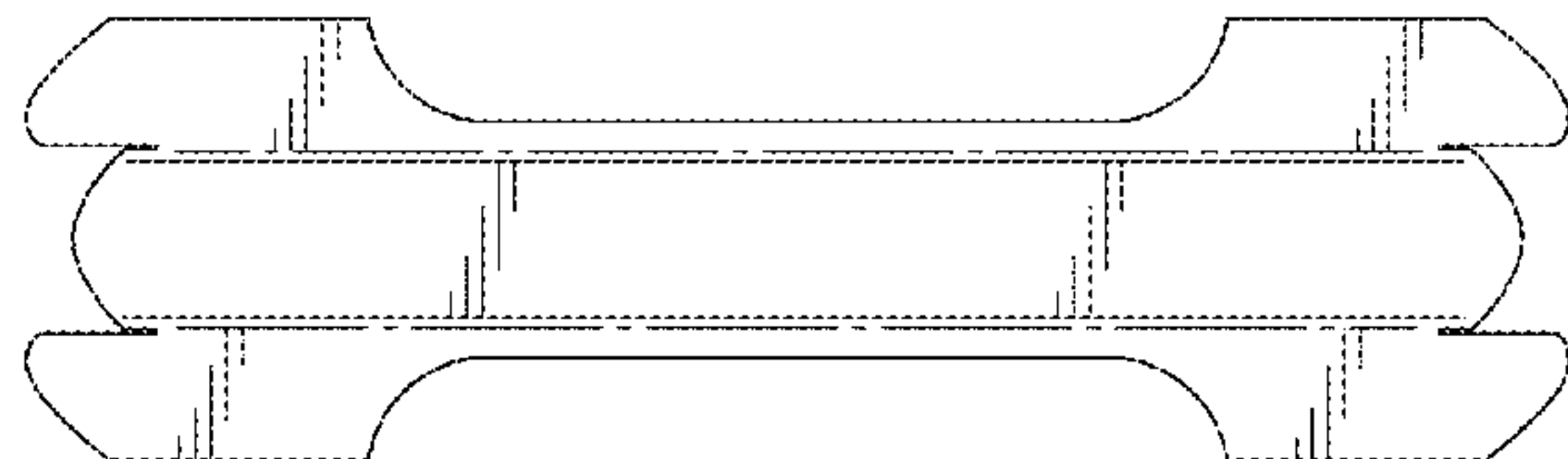
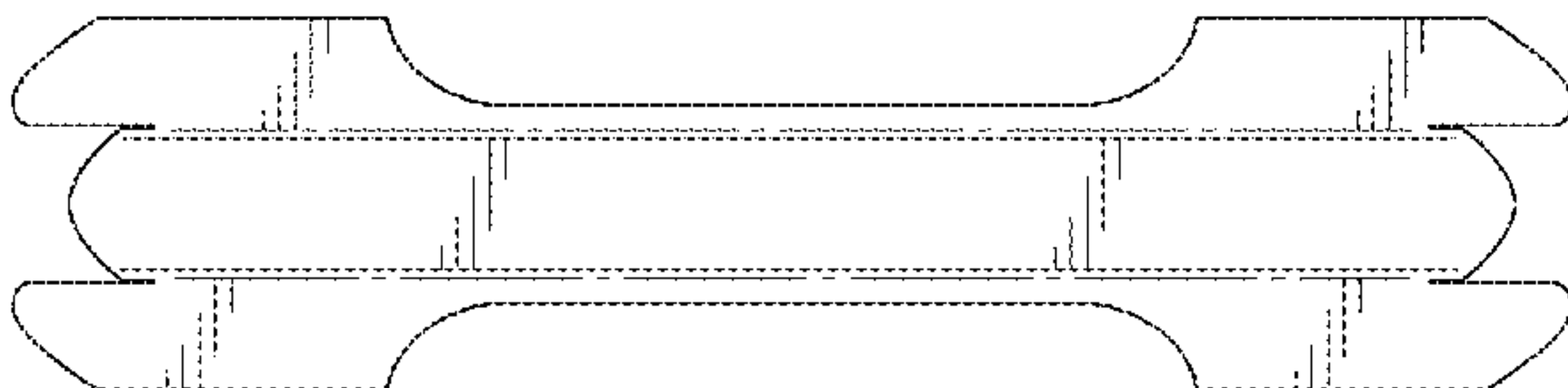

D672,872	S	12/2012	Brunner et al.	
D673,270	S	12/2012	Brunner et al.	
8,342,173	B2	1/2013	Lockwood, Jr.	
8,444,670	B2	5/2013	Ierulli	
8,584,671	B2	11/2013	Ierulli	
8,616,198	B2	12/2013	Guyuron et al.	
8,617,199	B2	12/2013	Eull et al.	
8,641,852	B2	2/2014	Ierulli	
D703,318	S *	4/2014	Brunner	D24/135
D707,814	S	6/2014	Ierulli	
D707,815	S	6/2014	Ierulli	
8,834,511	B2	9/2014	Holmes et al.	
8,834,512	B1	9/2014	Brown et al.	
8,834,514	B2	9/2014	Smith	
8,858,587	B2	10/2014	Ierulli	
D722,161	S	2/2015	Reyers	
D722,162	S	2/2015	Reyers	
D725,772	S	3/2015	Ierulli	
D725,773	S	3/2015	Ierulli	
9,095,422	B2	8/2015	Gray	
D738,496	S	9/2015	Peck	
D739,015	S	9/2015	Martin	
9,119,620	B2	9/2015	Peterson et al.	
D741,997	S	10/2015	Ierulli	
D741,998	S	10/2015	Martin	
D743,544	S	11/2015	Ierulli	
D743,545	S	11/2015	Ierulli	
D743,565	S	11/2015	Engel et al.	
D745,147	S	12/2015	Ierulli	
9,204,988	B1	12/2015	Fischell	
D746,982	S	1/2016	Ierulli	
D747,478	S	1/2016	Brunner et al.	
D753,294	S	4/2016	Guyuron et al.	
D755,376	S	5/2016	Ierulli	
D758,575	S	6/2016	Ierulli	
D758,576	S	6/2016	Ierulli et al.	
D759,240	S	6/2016	Ierulli	
D759,241	S	6/2016	Ierulli	
D759,242	S	6/2016	Ierulli	
9,364,367	B2	6/2016	Ierulli	
9,364,368	B2	6/2016	Ierulli	
9,381,332	B2	7/2016	Judd	
D764,055	S	8/2016	Ierulli et al.	
D764,662	S	8/2016	Ierulli et al.	
9,414,957	B1	8/2016	Fischell	
9,427,945	B2	8/2016	Gray et al.	
D779,666	S	2/2017	Ierulli et al.	
D779,667	S	2/2017	Ierulli et al.	
9,566,183	B1	2/2017	Fischell	
D789,531	S *	6/2017	Ierulli	D24/135
D791,314	S *	7/2017	Ierulli	D24/135
2002/0000227	A1 *	1/2002	Duyke	A61F 5/08 128/200.24
2008/0058858	A1	3/2008	Smith	
2008/0097517	A1	4/2008	Holmes et al.	
2009/0125052	A1	5/2009	Pinna et al.	
2009/0234383	A1	9/2009	Ierulli	
2010/0210988	A1	8/2010	Dallison	
2010/0298861	A1	11/2010	Fenton	
2011/0000483	A1	1/2011	Matthias et al.	
2011/0054517	A1	3/2011	Holmes et al.	
2011/0093004	A1 *	4/2011	Ierulli	A61F 5/08 606/204.45
2011/0166594	A1	7/2011	Eull	
2011/0224717	A1	9/2011	Lockwood	
2012/0004683	A1	1/2012	Gray	
2012/0022582	A1	1/2012	Guyuron	
2012/0067345	A1	3/2012	Shilon	
2012/0172923	A1	7/2012	Fenton	
2012/0209313	A1	8/2012	Ierulli	
2012/0232455	A1	9/2012	Beaudry	
2013/0104882	A1	5/2013	Ierulli	
2013/0118488	A1	5/2013	Ledogar	

2014/0194922	A1	7/2014	Ierulli
2014/0148844	A1	10/2014	Andre
2014/0296904	A1	10/2014	Andre
2014/0350596	A1	11/2014	Smith
2015/0005812	A1	1/2015	Holmes
2015/0012035	A1	1/2015	Ierulli
2015/0051636	A1	2/2015	Lockwood
2015/0090398	A1	4/2015	Ierulli
2015/0090399	A1	4/2015	Ierulli
2015/0094757	A1	4/2015	Ierulli
2015/0094758	A1	4/2015	Ierulli
2015/0216709	A1	8/2015	Peck
2015/0230966	A1	8/2015	Ierulli
2015/0250637	A1	9/2015	Ierulli
2015/0290021	A1	10/2015	Gray
2015/0359654	A1	12/2015	Bentivegna et al.
2016/0008161	A1	1/2016	Ierulli et al.
2016/0278967	A1	9/2016	Ierulli
2016/0278968	A1	9/2016	Ierulli
2016/0339619	A1	11/2016	Gray

FOREIGN PATENT DOCUMENTS

EP	855175	*	7/1998
ES	289561	*	10/1985

OTHER PUBLICATIONS

Amazon. <URL: [* cited by examiner](https://www.amazon.com/Sleepeze-Remedies-Snoring-Breathe-Congestion/dp/B071WQGK3T/ref=sr_1_2_a_it?ie=UTF8&qid=1512418472&sr=8-2&keywords=Sleepeze+Remedies.> Sep. 7, 2017. Nasal Strips.*</p>
</div>
<div data-bbox=)

Primary Examiner — Lauren McVey
(74) *Attorney, Agent, or Firm* — Mersenne Law

(57) **CLAIM**

The ornamental design for a nasal dilator, as shown and described.

DESCRIPTION

FIG. 1 is a perspective view of a first embodiment of a nasal dilator showing my new design;
 FIG. 2 is a top plan view thereof;
 FIG. 3 is a front view thereof, the rear view being a mirror image thereof;
 FIG. 4 is a right side view thereof, the left side view being a mirror image thereof;
 FIG. 5 is a bottom plan view thereof;
 FIG. 6 is a perspective view of a second embodiment of a nasal dilator showing my new design;
 FIG. 7 is a top plan view thereof;
 FIG. 8 is a front view thereof, the rear view being a mirror image thereof;
 FIG. 9 is a right side view thereof, the left side view being a mirror image thereof; and,
 FIG. 10 is a bottom plan view thereof.
 The broken line showing of human facial features is directed to environment and is for illustrative purposes only; the broken lines form no part of the claimed design.

1 Claim, 2 Drawing Sheets

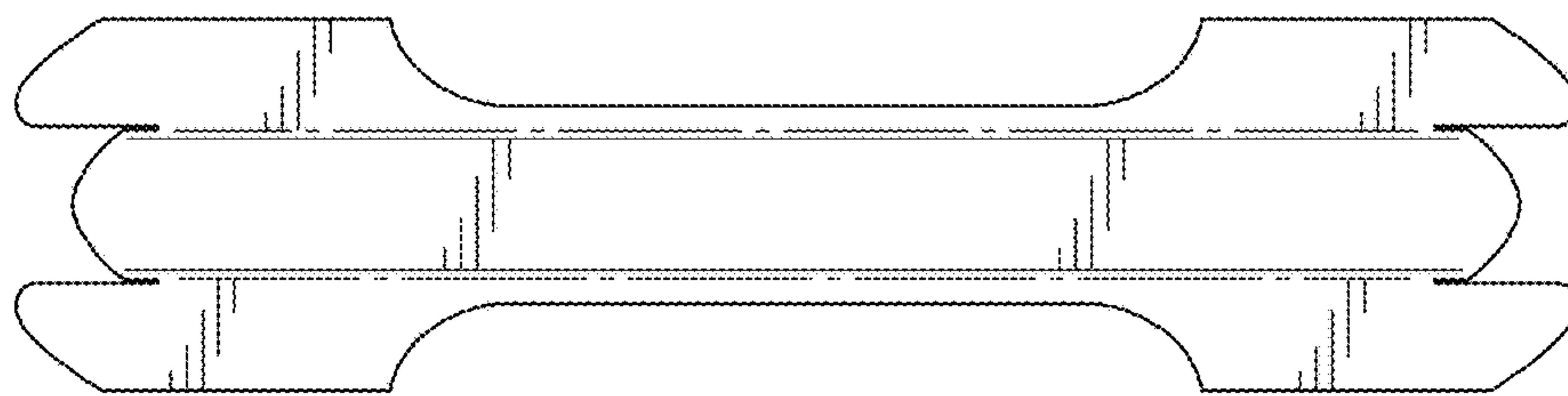
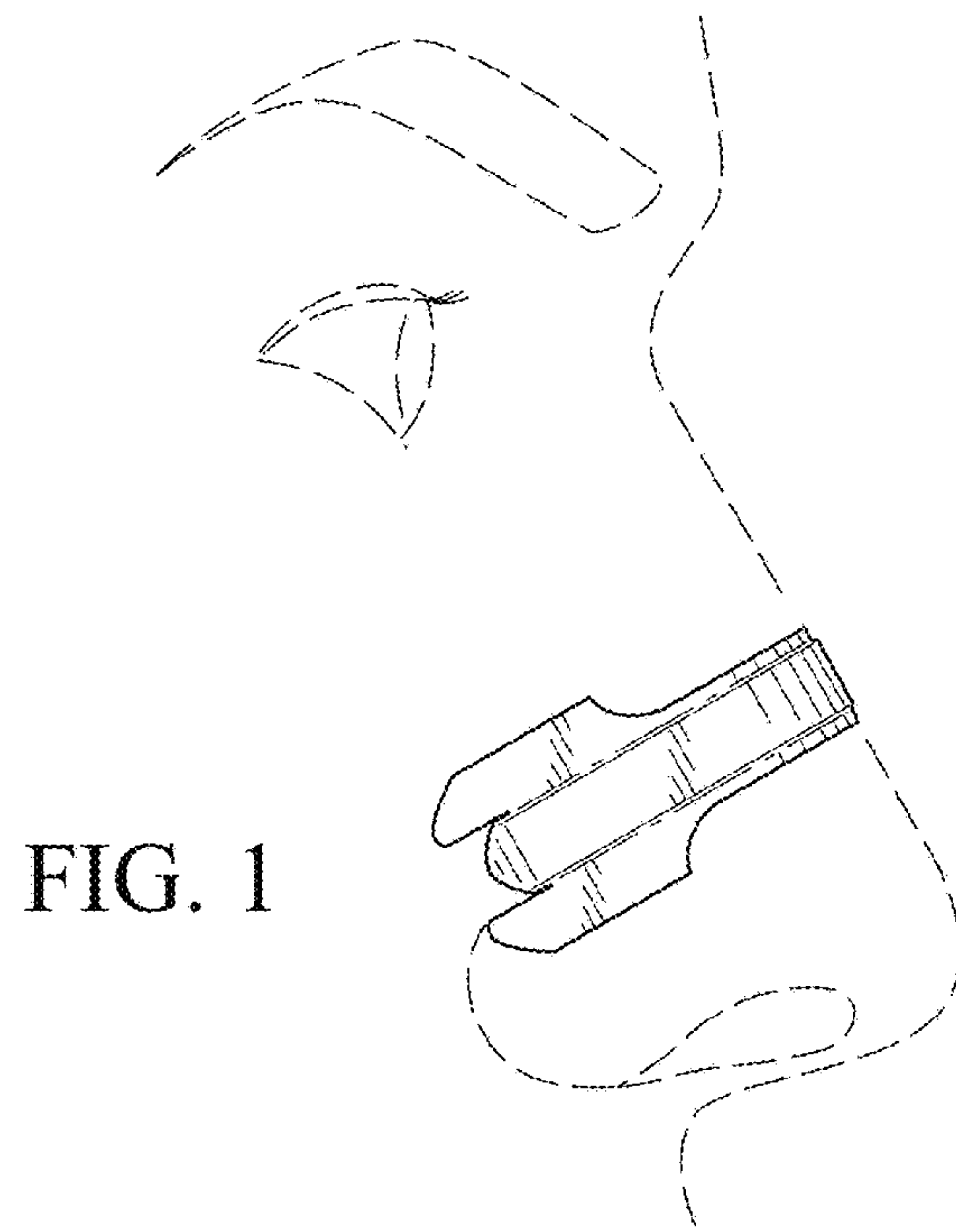

FIG. 2



FIG. 4

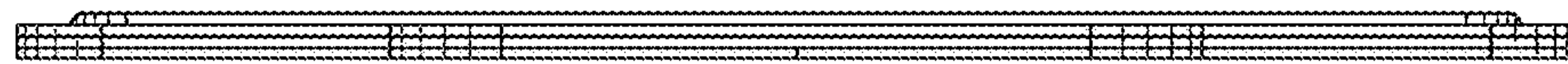

FIG. 3

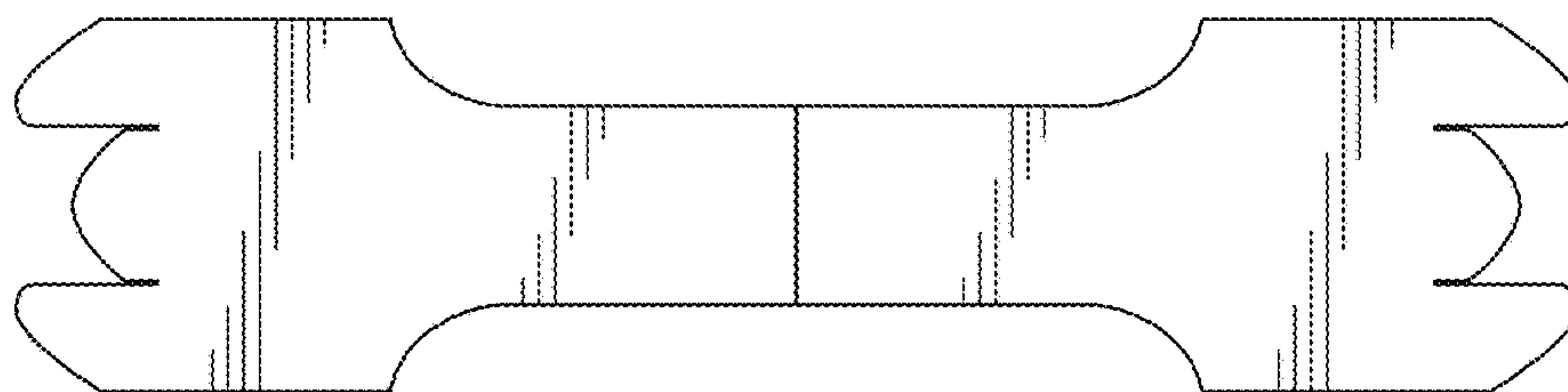

FIG. 5

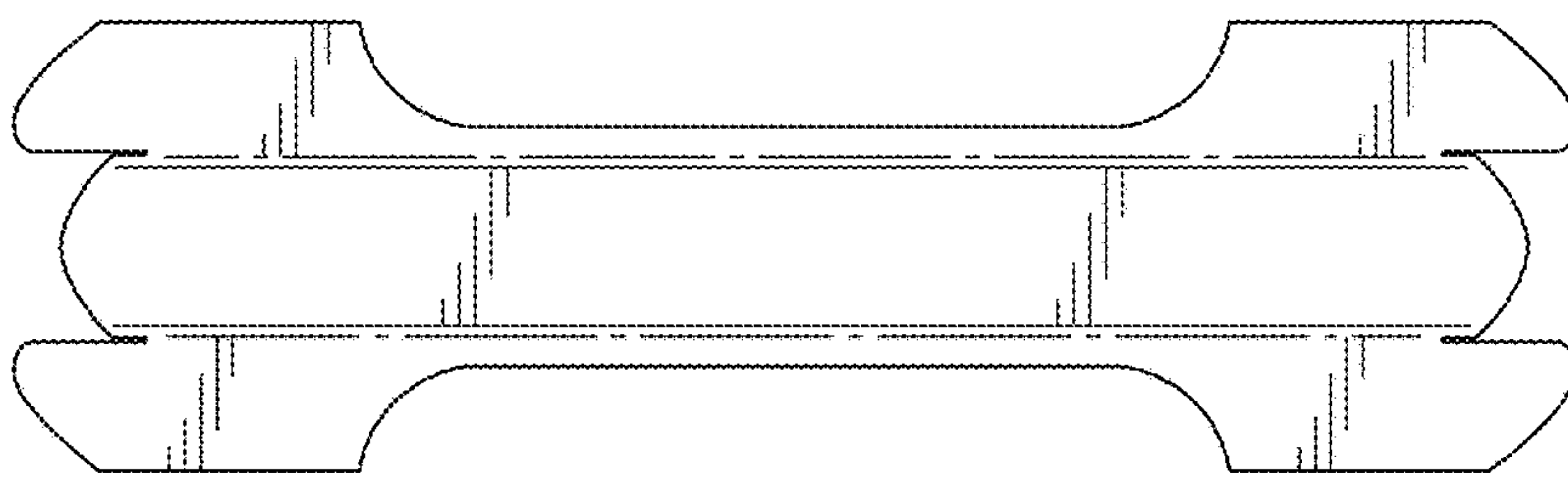
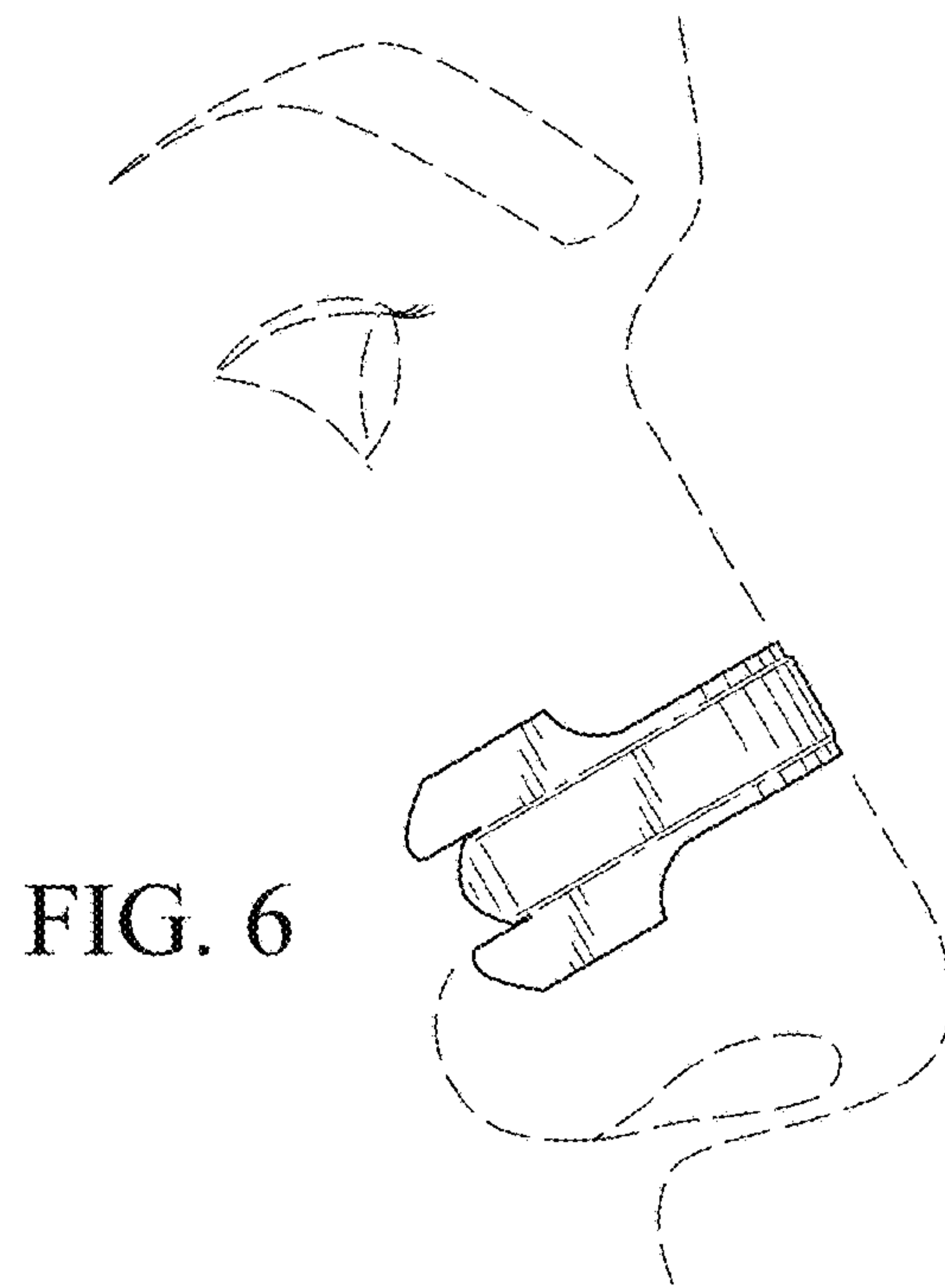

FIG. 9

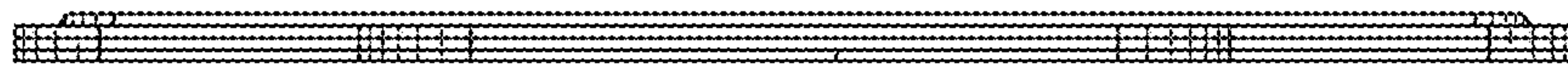
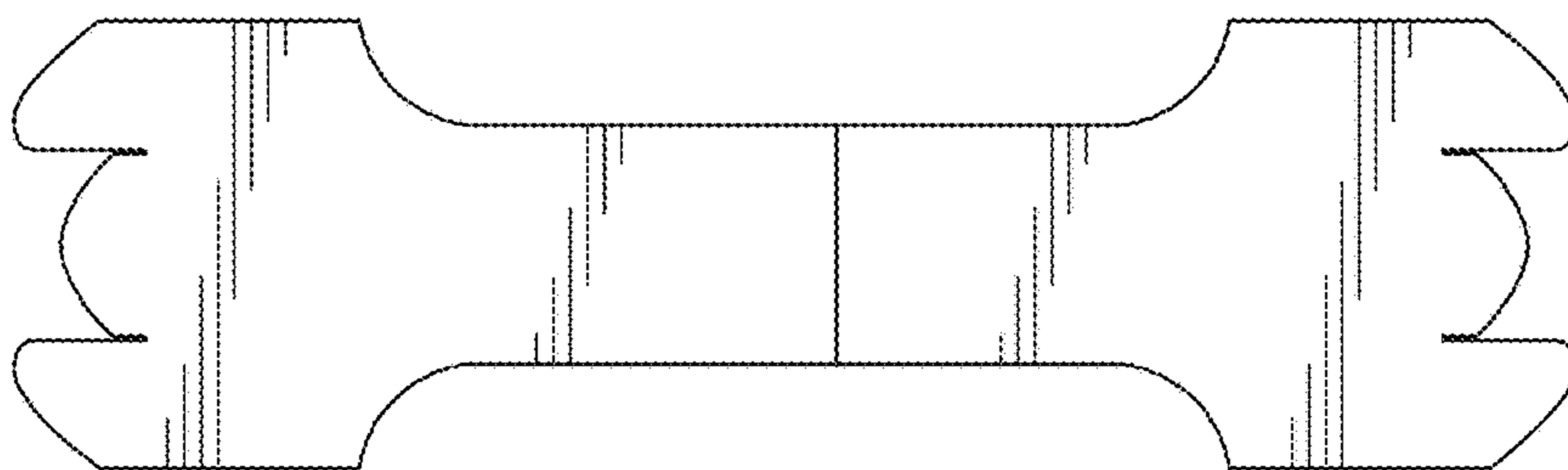

FIG. 8



UNITED STATES PATENT AND TRADEMARK OFFICE
CERTIFICATE OF CORRECTION

PATENT NO. : D814,029 S
APPLICATION NO. : 29/603526
DATED : March 27, 2018
INVENTOR(S) : Joseph V. Ierulli

Page 1 of 4

It is certified that error appears in the above-identified patent and that said Letters Patent is hereby corrected as shown below:

On the Title Page

Delete the title page and substitute therefore with the attached title page consisting of the corrected illustrative figure(s).

In the Drawings

Please replace FIGS. 1-10 with FIGS. 1-10 as shown on the attached pages.

Signed and Sealed this
Thirtieth Day of July, 2019

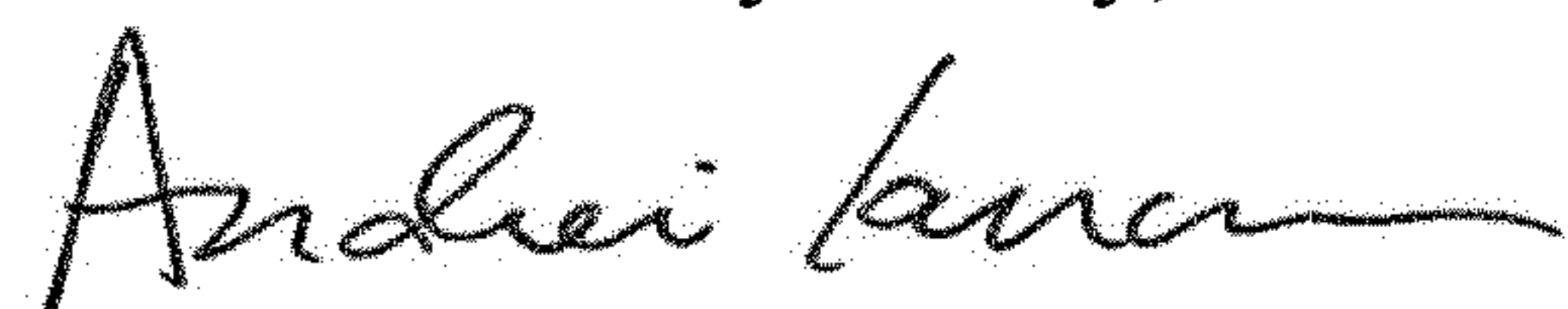

Andrei Iancu
Director of the United States Patent and Trademark Office

(12) **United States Design Patent** (10) **Patent No.:** **US D814,029 S**
Ierulli (45) **Date of Patent:** **** Mar. 27, 2018**

(54) **NASAL DILATOR**

(71) Applicant: **Joseph V. Ierulli**, Bradenton, FL (US)

(72) Inventor: **Joseph V. Ierulli**, Bradenton, FL (US)

(73) Assignee: **Corbett Lair Inc.**, Bradenton, FL (US)

(**) Term: **15 Years**

(21) Appl. No.: **29/603,526**

(22) Filed: **May 10, 2017**

Related U.S. Application Data

(60) Continuation of application No. 29/562,930, filed on Apr. 29, 2016, now Pat. No. Des. 791,314, which is a continuation of application No. 29/542,489, filed on Oct. 14, 2015, now Pat. No. Des. 759,241, which is a continuation of application No. 29/494,562, filed on Jun. 22, 2014, now Pat. No. Des. 743,545, which is a continuation of application No. 29/475,207, filed on Dec. 1, 2013, now Pat. No. Des. 741,997, which is a continuation of application No. 29/433,556, filed on Oct. 1, 2012, now Pat. No. Des. 707,814, which is a continuation of application No. 29/420,787, filed on May 13, 2012, now Pat. No. Des. 671,643, which is a continuation of application No. 29/399,247, filed on Aug. 11, 2011, now Pat. No. Des. 667,543, which is a division of application No. 29/380,763, filed on Dec. 10, 2010, now Pat. No. Des. 659,245, which is a continuation-in-part of application No. 12/106,289, filed on Apr. 19, 2008, now Pat. No. 8,062,329.

(51) **LOC (II) CL.** **24-02**

(52) **U.S. CL.**
 USPC **D24/135**

(58) **Field of Classification Search**
 USPC D24/133, 135, 136, 189
 CPC A61F 5/08; A61B 17/0057; A61B 1/233;
 A61M 29/00; A61M 29/02
 See application file for complete search history.

(56) **References Cited**

U.S. PATENT DOCUMENTS

5,476,091 A	12/1995	Johnson	
5,479,944 A	1/1996	Petruson	
5,533,499 A	7/1996	Johnson	
5,533,503 A	7/1996	Doubek et al.	
5,546,929 A	8/1996	Muchin	
5,549,103 A	8/1996	Johnson	
RE35,408 E	12/1996	Petruson	
5,611,333 A	3/1997	Johnson	
5,653,224 A	8/1997	Johnson	
5,706,800 A	1/1998	Cronk et al.	
5,718,224 A	2/1998	Muchin	
5,769,089 A	6/1998	Hand et al.	
5,842,469 A *	12/1998	Rapp	A61F 5/08 128/200.24
5,890,486 A	4/1999	Mitra et al.	
5,931,854 A	8/1999	Dillon	
5,957,126 A	9/1999	Neeser	
6,006,746 A	12/1999	Karell	
6,029,658 A	2/2000	De Voss	
6,058,931 A	5/2000	Muchin	
6,065,470 A	5/2000	Var	
6,098,616 A	8/2000	Lui	
6,196,228 B1	3/2001	Kreitzer et al.	
6,244,265 B1	6/2001	Cronk et al.	
6,276,360 B1	8/2001	Cronk et al.	
6,318,362 B1	11/2001	Johnson	
6,357,436 B1	3/2002	Kreitzer et al.	
6,375,667 B1	4/2002	Ruch	
6,453,901 B1	9/2002	Ierulli	
6,470,883 B1	10/2002	Beaudry	
6,550,474 B1	4/2003	Anderson et al.	
6,694,970 B2	2/2004	Spinelli et al.	
6,769,428 B2	8/2004	Cronk et al.	
6,769,429 B1	8/2004	Benetti	
7,067,710 B1	6/2006	Beaudry	
7,114,495 B2	10/2006	Lockwood, Jr.	
D639,762 S	6/2011	Brogden et al.	
D644,325 S	8/2011	Brunner et al.	
D644,324 S	10/2011	Brunner et al.	
8,047,201 B2	11/2011	Guyuron et al.	
8,062,329 B2	11/2011	Ierulli	
D651,710 S	1/2012	Brogden et al.	
8,115,049 B2	2/2012	Beaudry	
D659,245 S	5/2012	Ierulli	
8,188,330 B2	5/2012	Beaudry	
D662,203 S	6/2012	Smith	
D667,543 S	9/2012	Ierulli	
D671,643 S	11/2012	Ierulli	
D672,461 S	12/2012	Brogden et al.	

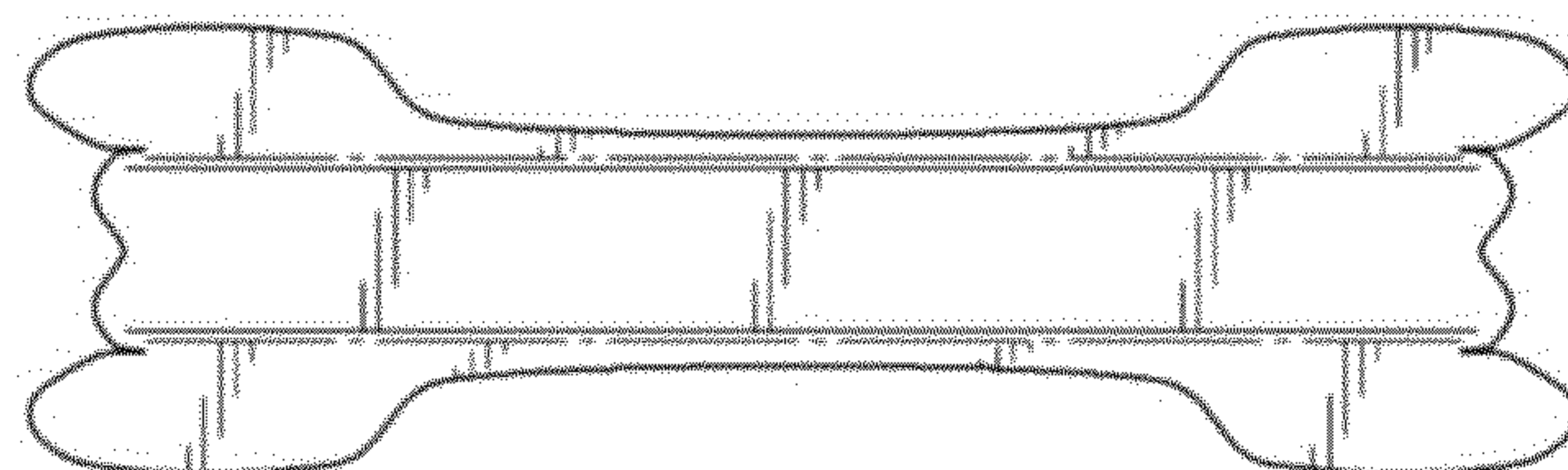
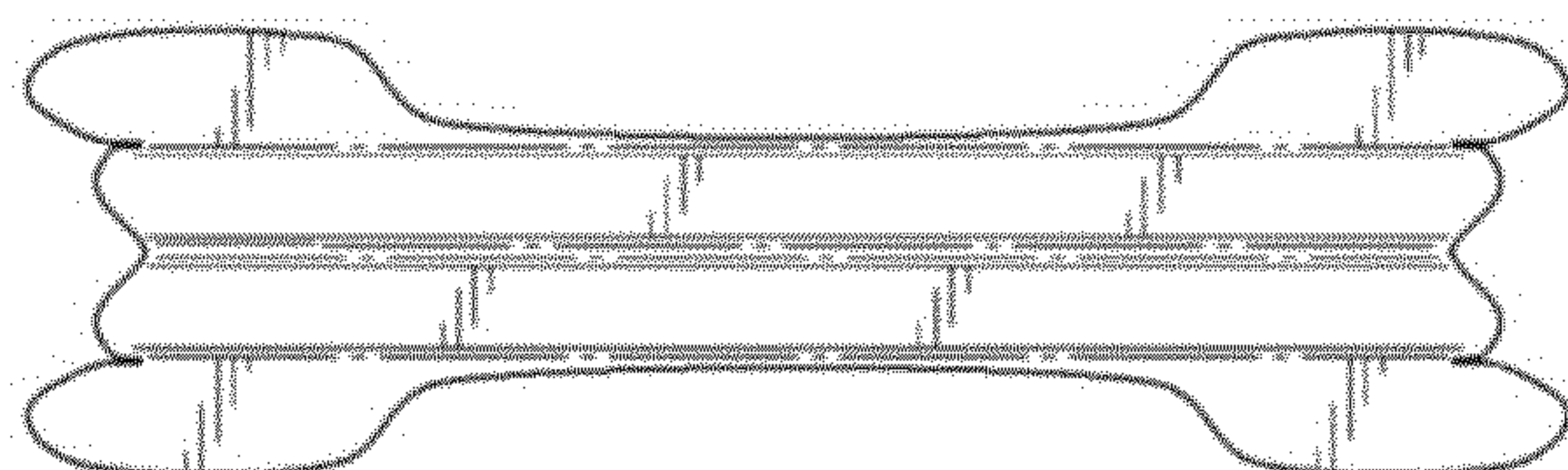

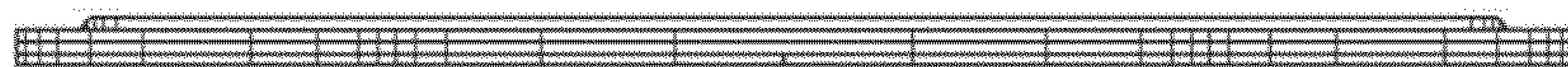
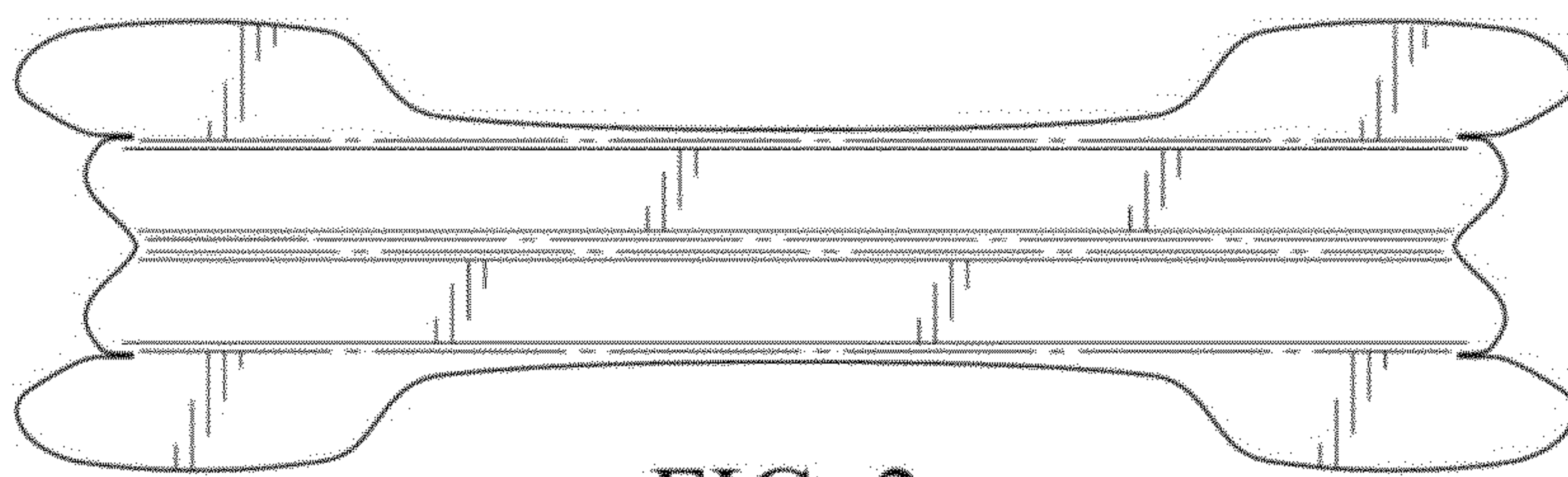
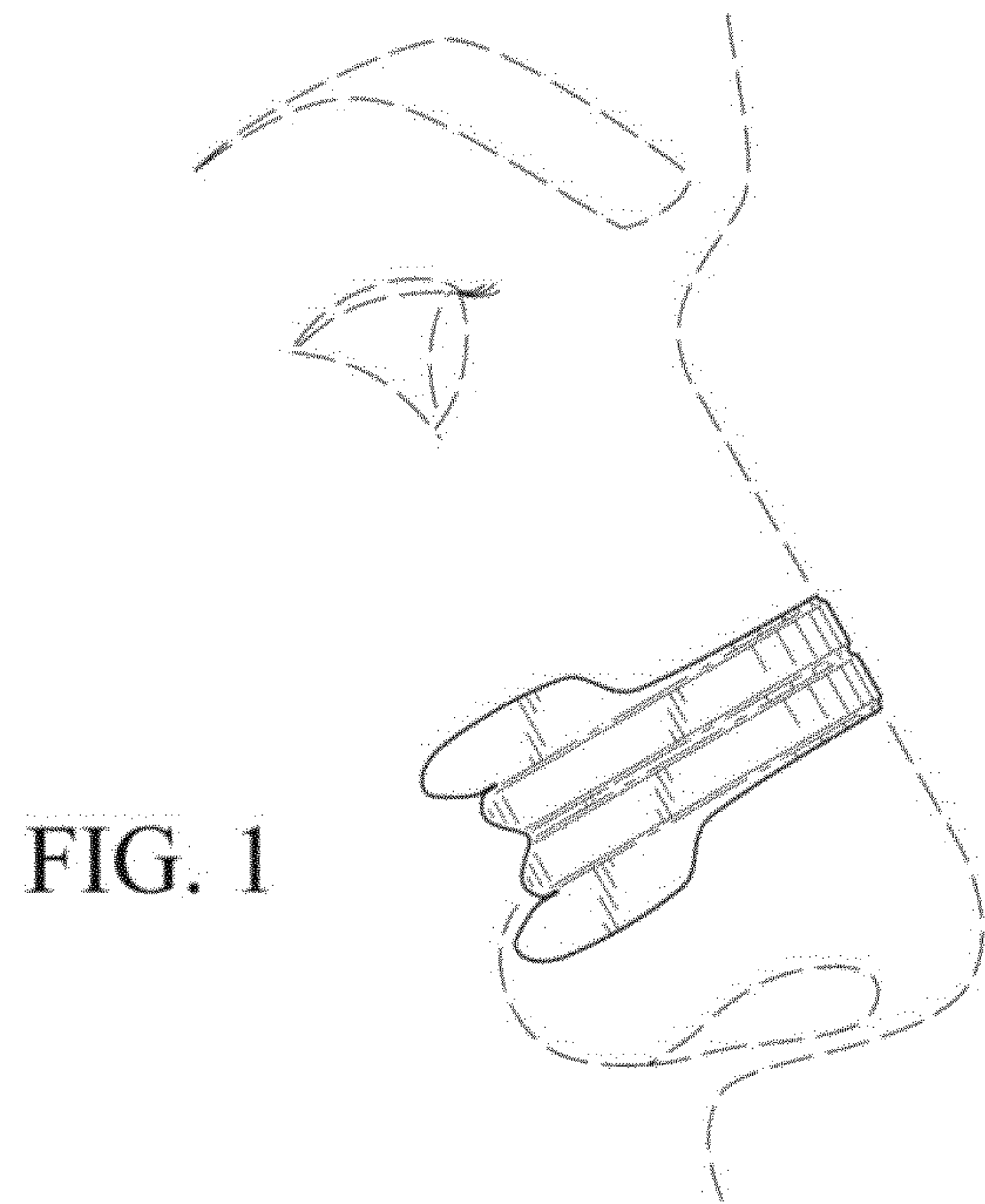

FIG. 4

FIG. 3

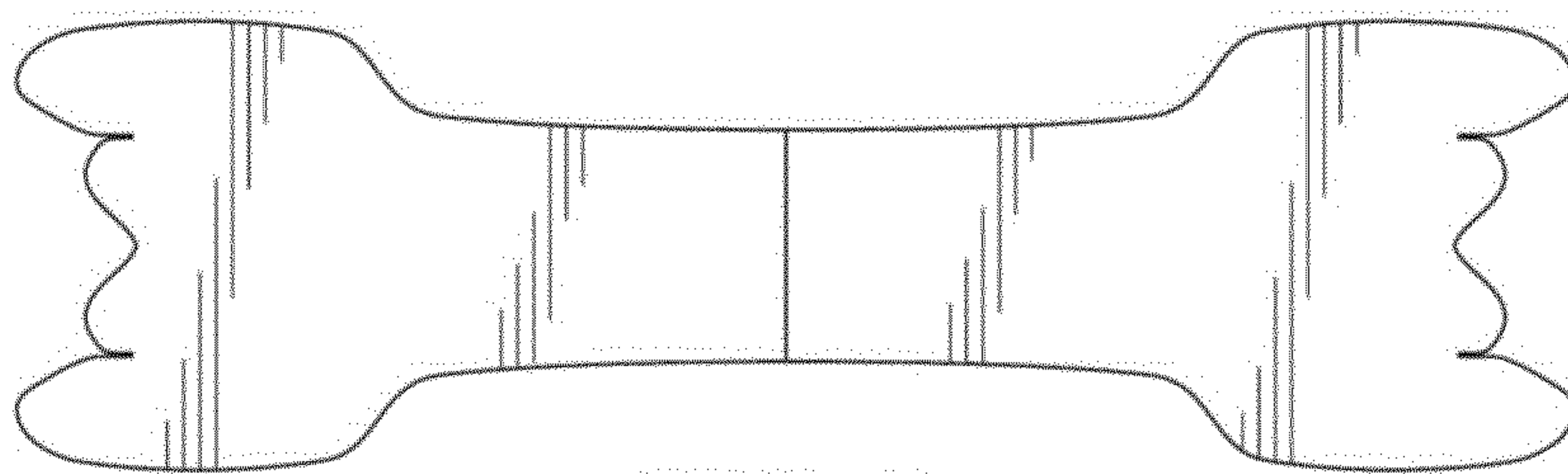

FIG. 5

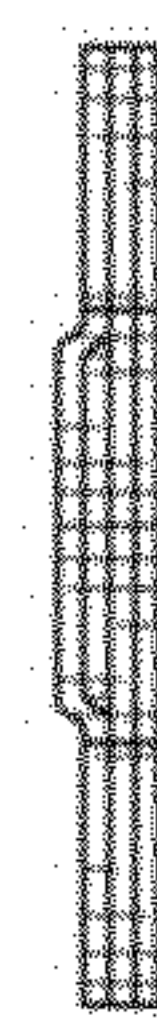
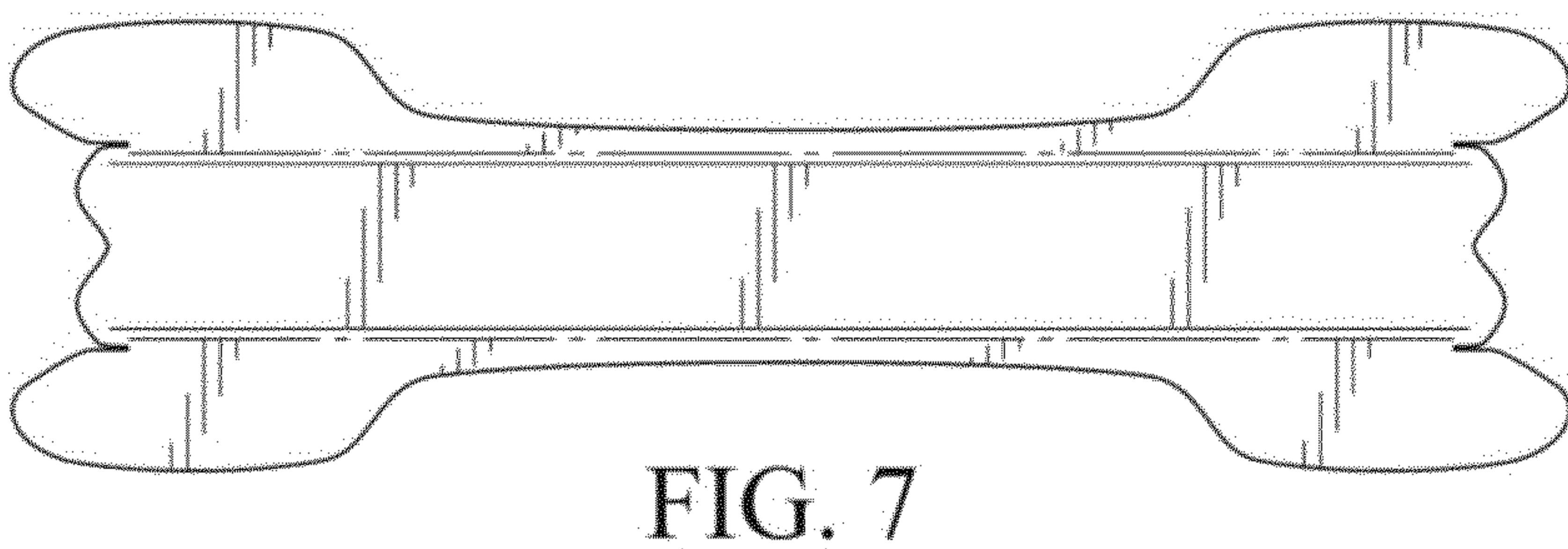
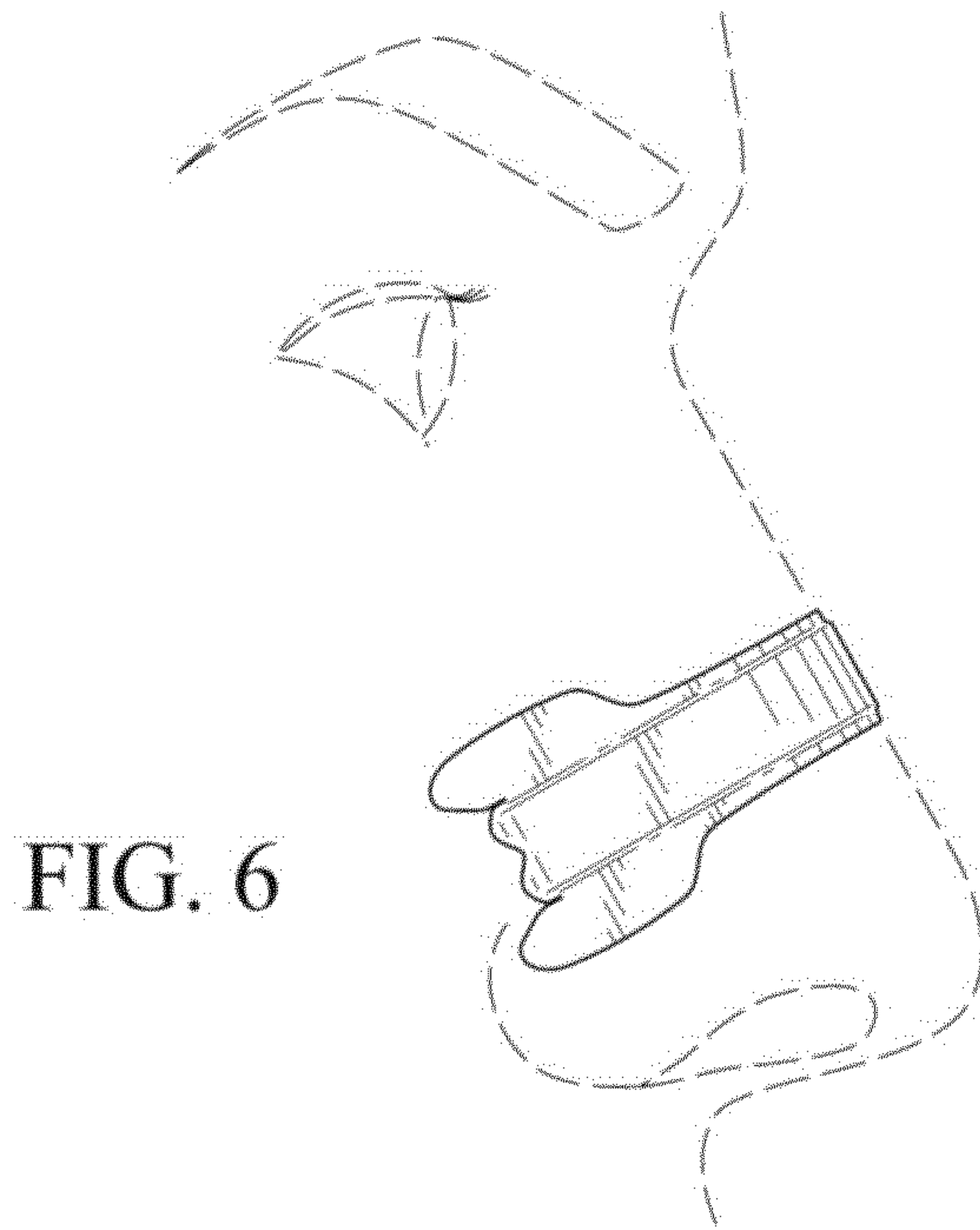

FIG. 9

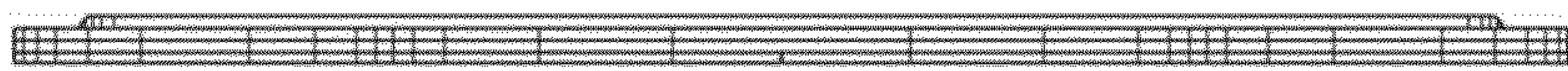

FIG. 8

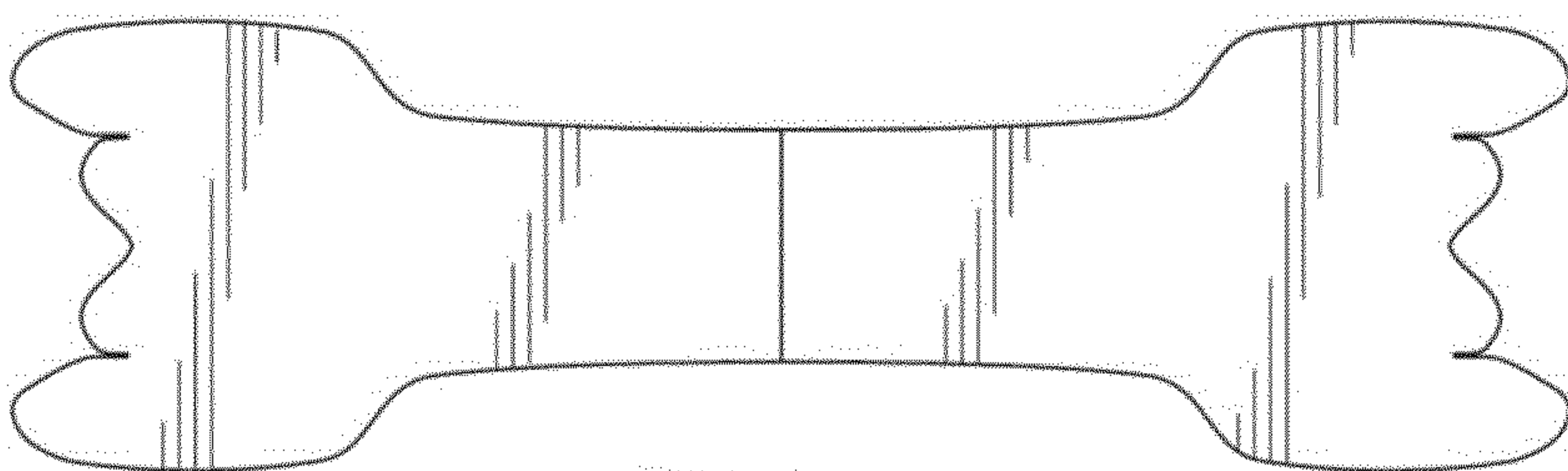

FIG. 10