



US00D813738S

(12) **United States Design Patent**
Holstein

(10) **Patent No.:** **US D813,738 S**
(45) **Date of Patent:** **** Mar. 27, 2018**

(54) **FRONT BUMPER FOR A VEHICLE**
(71) Applicant: **Bayerische Motoren Werke Aktiengesellschaft, Munich (DE)**
(72) Inventor: **Henning Holstein, Munich (DE)**
(73) Assignee: **Bayerische Motoren Werke Aktiengesellschaft, Munich (DE)**
(**) Term: **15 Years**

D561,072 S * 2/2008 Golden D12/169
D563,843 S * 3/2008 Kido D12/169
D573,068 S * 7/2008 Gresens D12/169
D711,295 S * 8/2014 Mackay D12/169
D737,740 S * 9/2015 Goeppel D12/169
D738,799 S 9/2015 Goeppel
D771,530 S 11/2016 Schneider

(21) Appl. No.: **29/580,668**
(22) Filed: **Oct. 12, 2016**

FOREIGN PATENT DOCUMENTS

WO WO DM/082111 5/2014
WO WO DM/084240 2/2015

(30) **Foreign Application Priority Data**

Apr. 13, 2016 (DE) 40 2016 100 489

* cited by examiner

Primary Examiner — Melody N Brown

(74) *Attorney, Agent, or Firm* — Crowell & Moring LLP

(51) **LOC (11) Cl.** **12-16**
(52) **U.S. Cl.**
USPC **D12/169**

(58) **Field of Classification Search**
USPC D12/169, 216, 90-92, 86, 171, 196, 163;
293/102, 113, 115, 117, 120; 296/180.1,
296/180.2
CPC B60R 19/02; B60R 19/04; B62D 25/08
See application file for complete search history.

(57) **CLAIM**

The ornamental design for a front bumper for a vehicle, as shown and described.

(56) **References Cited**

U.S. PATENT DOCUMENTS

D548,146 S * 8/2007 Schiavone D12/169
D560,144 S * 1/2008 Tant D12/169

DESCRIPTION

FIG. 1 is a front view of a front bumper for a vehicle according to the design;
FIG. 2 is a right, front perspective view thereof;
FIG. 3 is a left, front perspective view thereof;
FIG. 4 is a right side view thereof;
FIG. 5 is a top view thereof;
FIG. 6 is a bottom view thereof; and,
FIG. 7 is a rear view thereof.

1 Claim, 7 Drawing Sheets

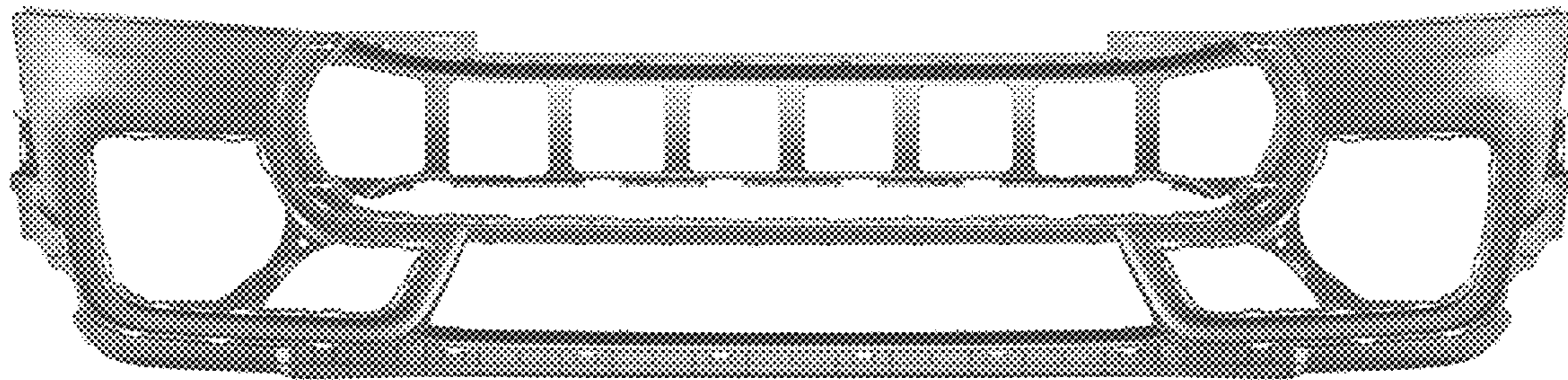

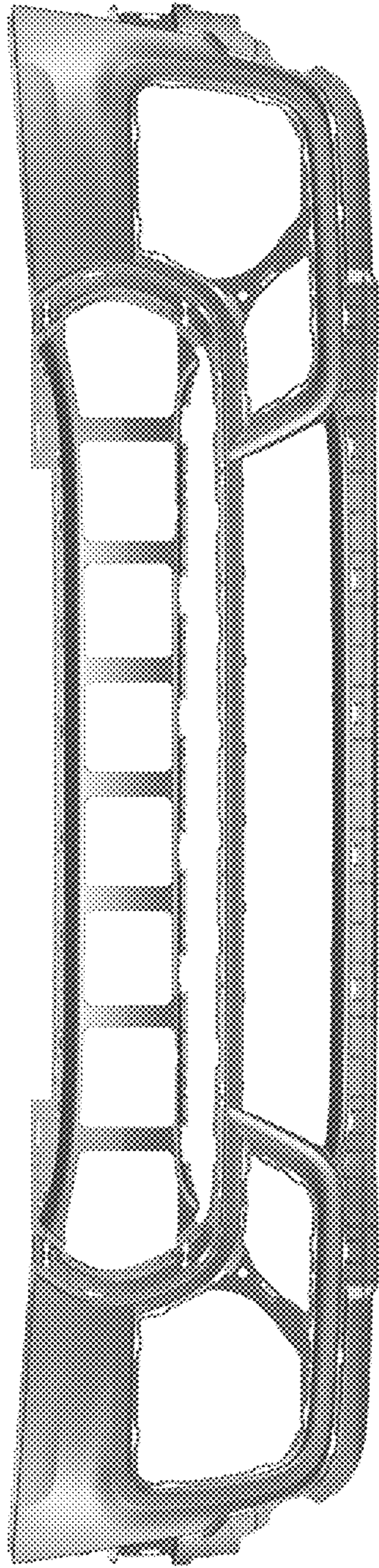

Fig. 1

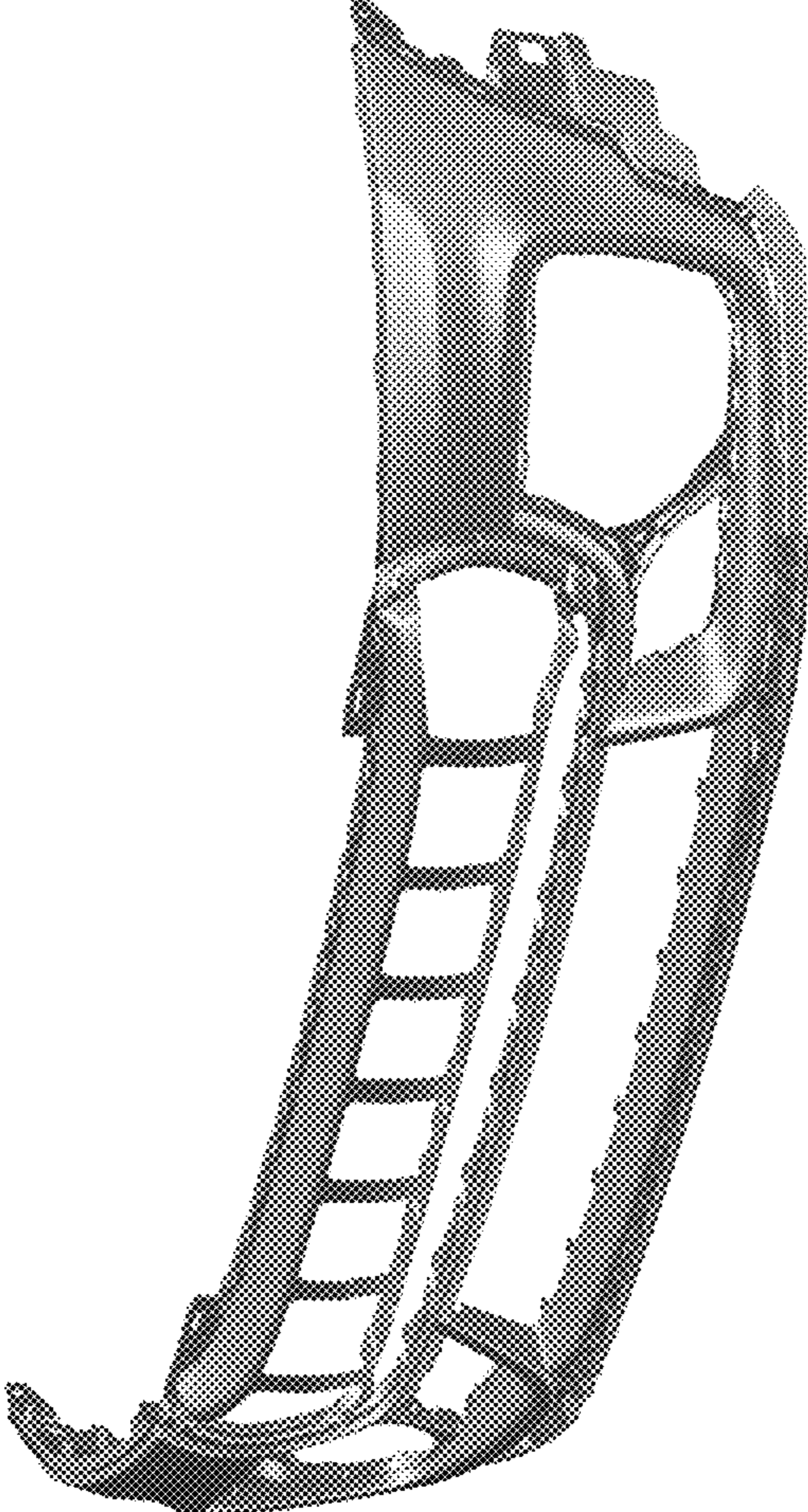

Fig. 2

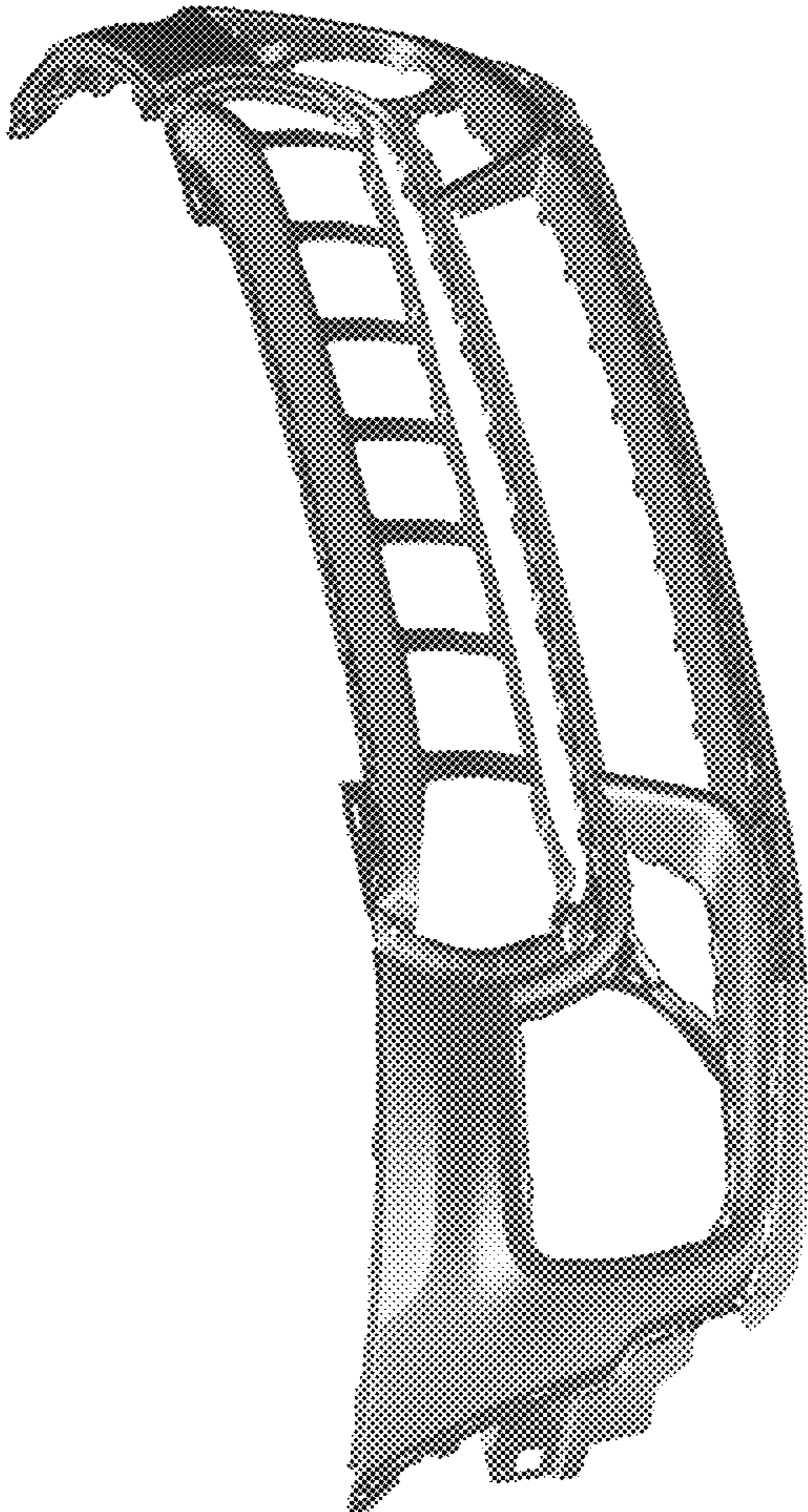

Fig. 3

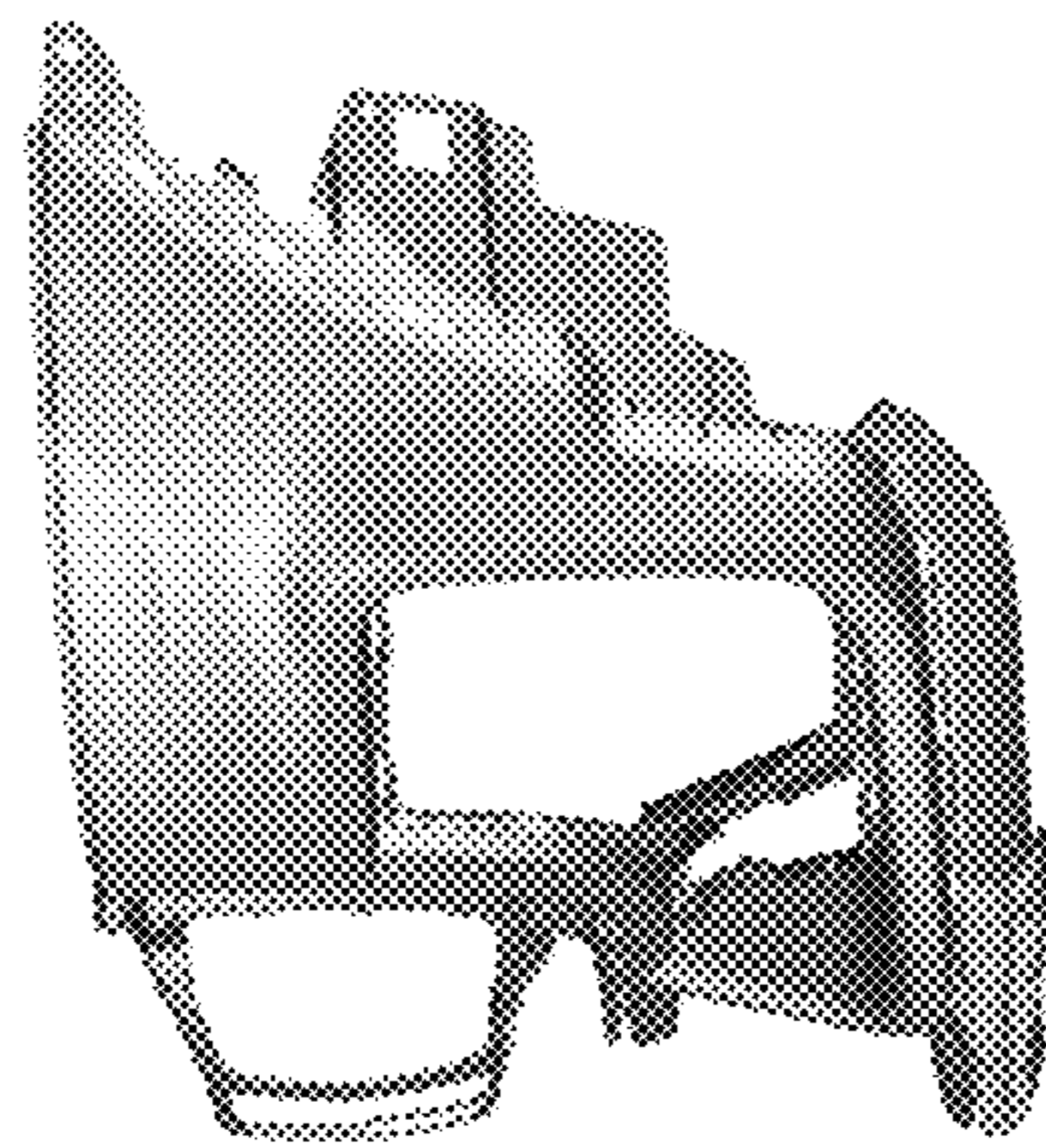

Fig. 4

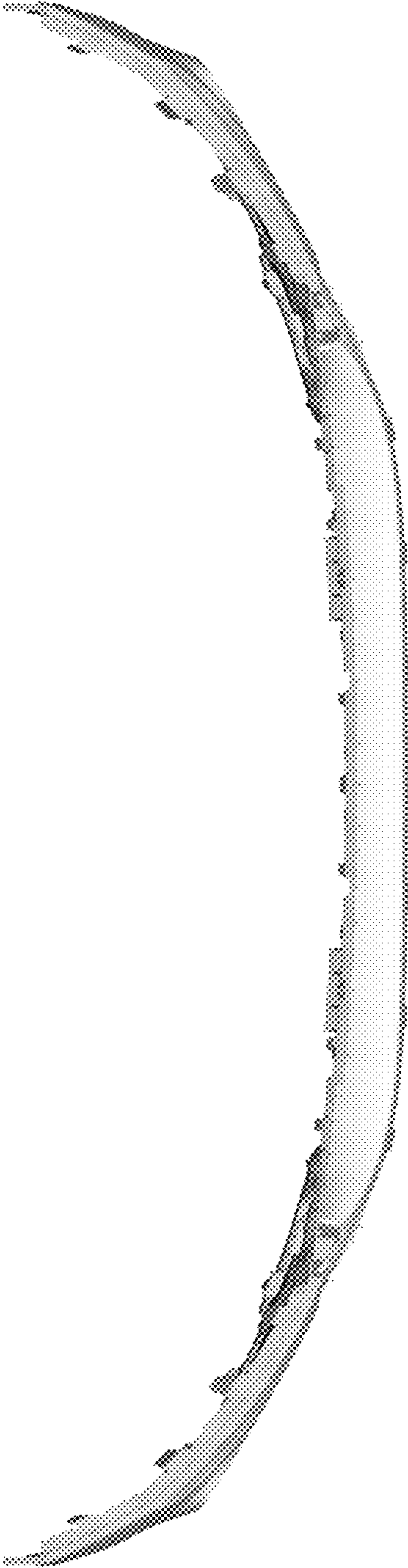

Fig. 5

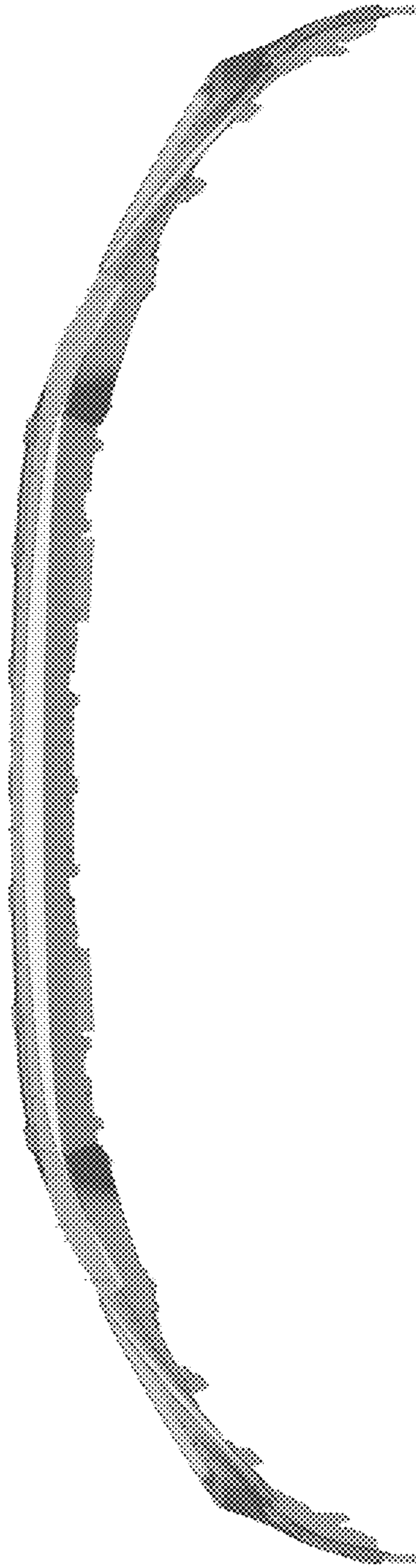

Fig. 6

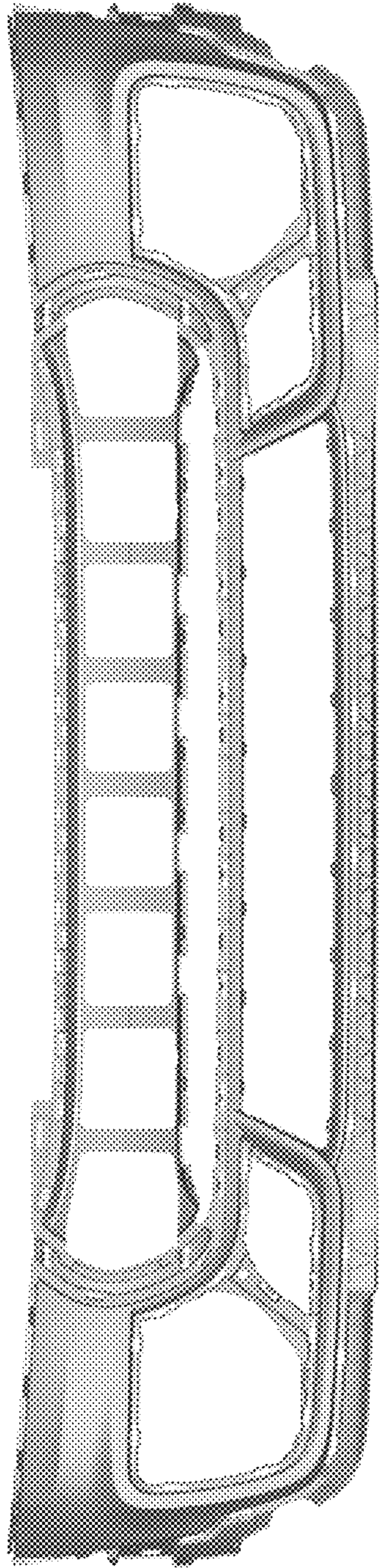

Fig. 7