



US00D813691S

(12) **United States Design Patent** (10) **Patent No.:** **US D813,691 S**  
**Plange** (45) **Date of Patent:** **\*\* Mar. 27, 2018**

(54) **WATCH WITH POWER RESERVE INDICATOR**

(71) Applicant: **RICHEMONT INTERNATIONAL SA, Villars-sur-Glâne (CH)**

(72) Inventor: **Gerd Thomas Rudolf Plange, Beringen (CH)**

(\*\*) Term: **15 Years**

(21) Appl. No.: **35/501,824**

(22) Filed: **May 3, 2016**

(80) **Hague Agreement Data**

Int. Filing Date: **May 3, 2016**

Int. Reg. No.: **DM/090658**

Int. Reg. Date: **May 3, 2016**

Int. Reg. Pub. Date: **Nov. 4, 2016**

(30) **Foreign Application Priority Data**

Nov. 4, 2015 (WO) ..... DM/088 152

(51) **LOC (11) Cl.** ..... **10-02**

(52) **U.S. Cl.**  
USPC ..... **D10/38**

(58) **Field of Classification Search**

USPC ..... D10/30, 38, 39, 126

CPC ..... G04B 19/04

See application file for complete search history.

(56) **References Cited**

U.S. PATENT DOCUMENTS

D697,435	S	*	1/2014	Duport	.....	D10/39
D747,658	S	*	1/2016	Cerrato	.....	D10/128
D756,245	S	*	5/2016	Mille	.....	D10/126
D762,491	S	*	8/2016	Okazaki	.....	D10/126
D801,196	S	*	10/2017	Sugiura	.....	D10/30
2010/0046328	A1	*	2/2010	Olsen	.....	G04B 19/04 368/30

\* cited by examiner

*Primary Examiner* — George D Kirschbaum

(57) **CLAIM**

The ornamental design for a watch with power reserve indicator, as shown and described.

**DESCRIPTION**

1. Watch with power reserve indicator

1.1 : Front

1.2 : Back

1.3 : Top

1.4 : Bottom

1.5 : Left

1.6 : Right

1.7 : Perspective

1.8 : Perspective

**1 Claim, 8 Drawing Sheets**

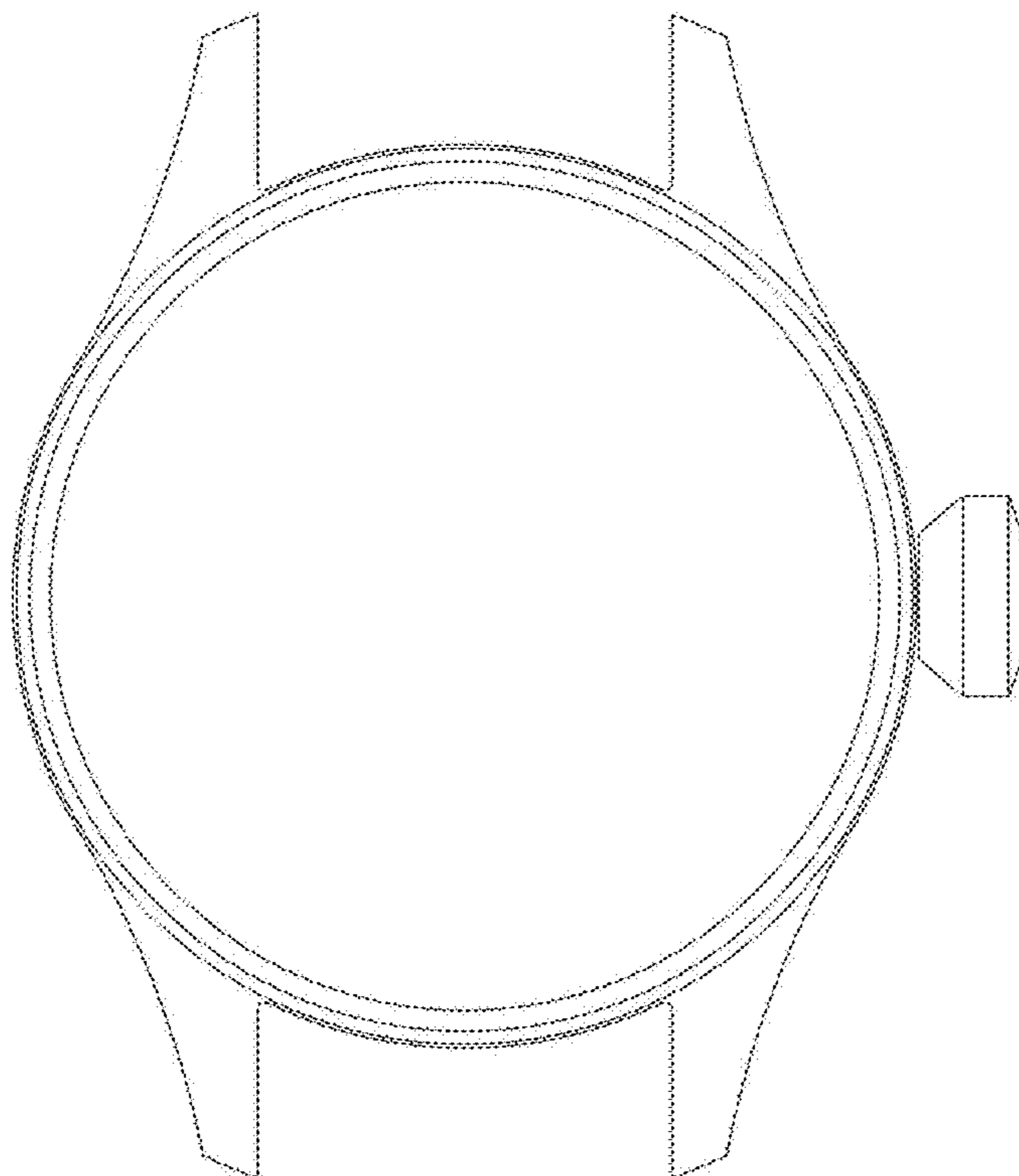

1.1

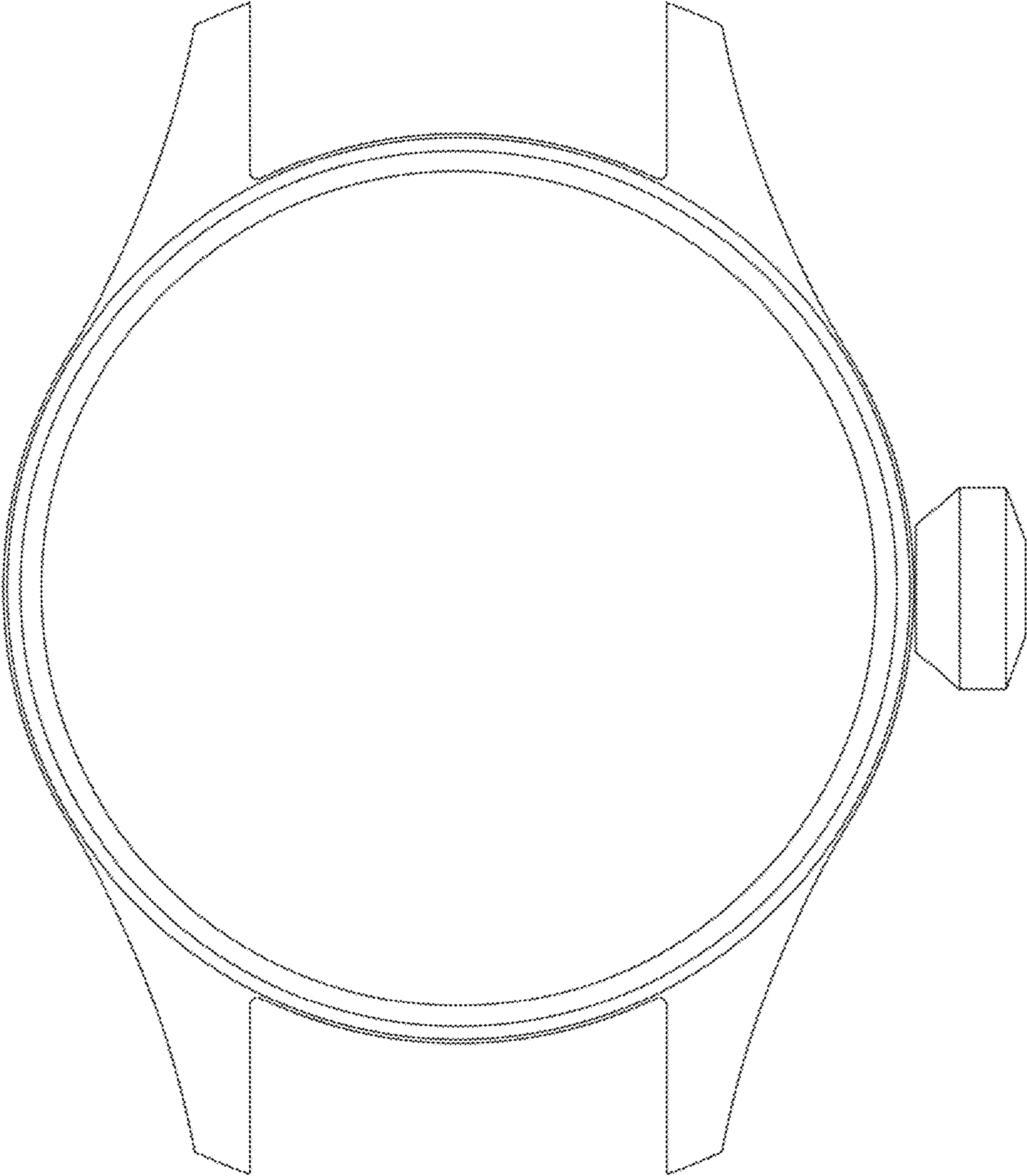

1.2

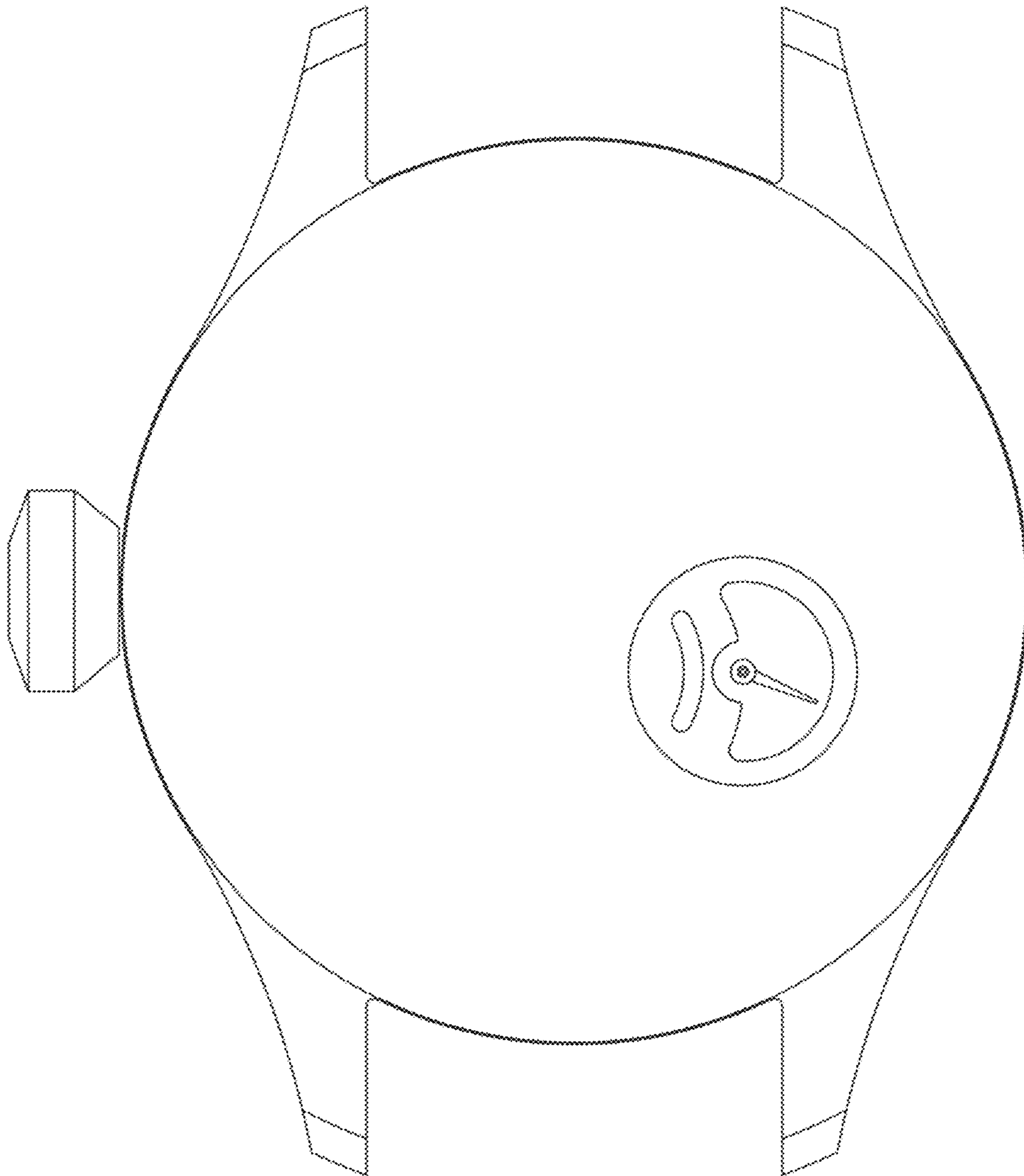

1.3

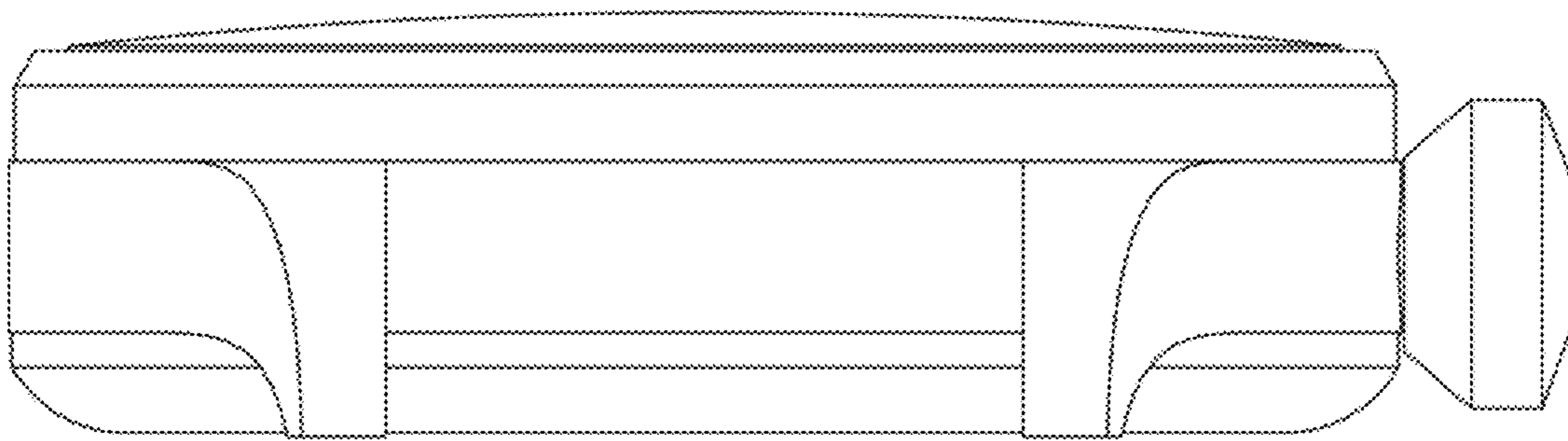

1.4

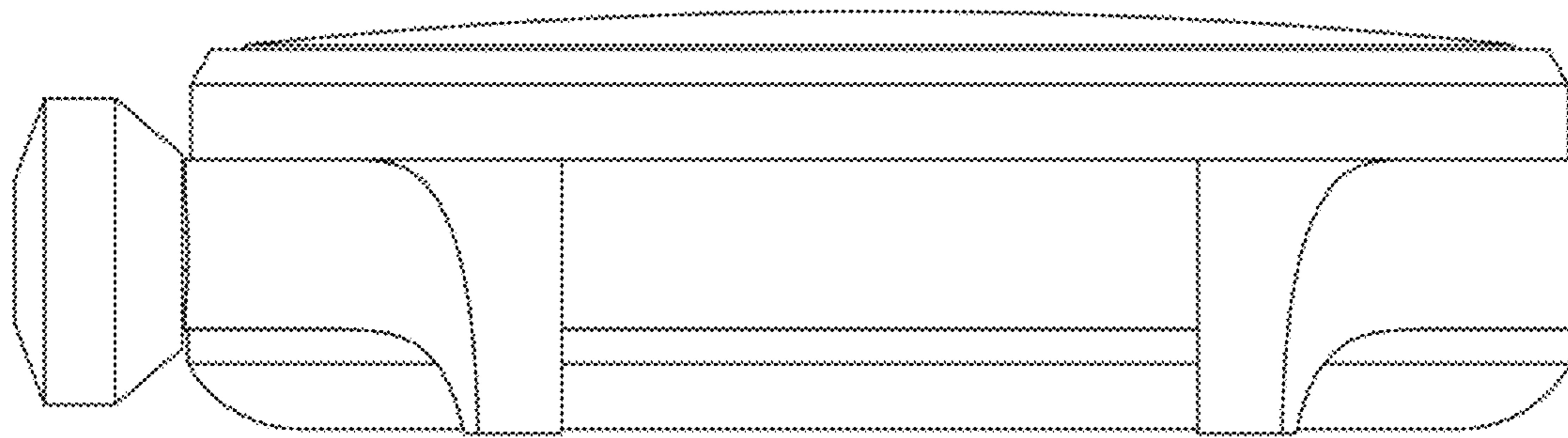

1.5

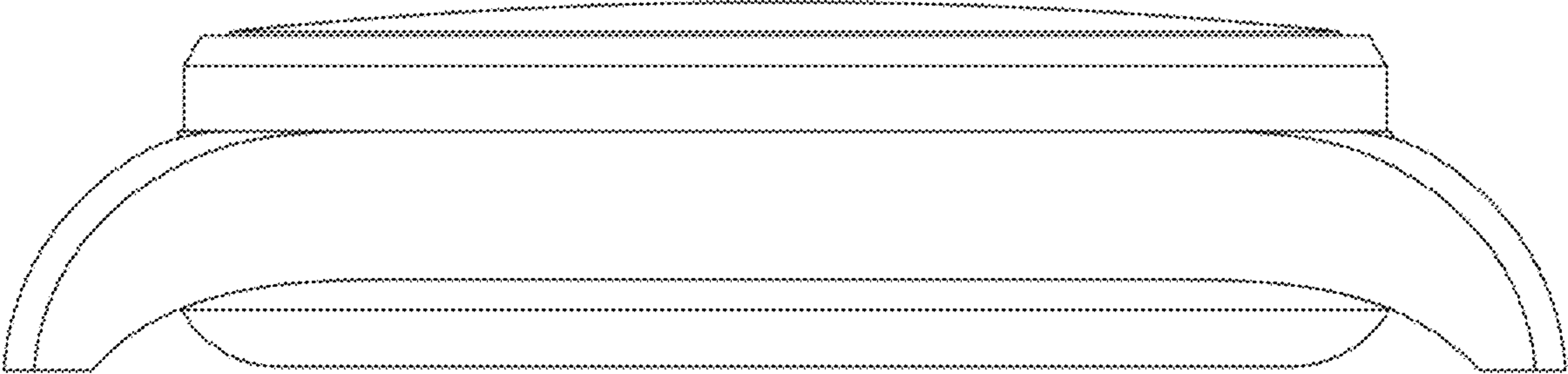

1.6

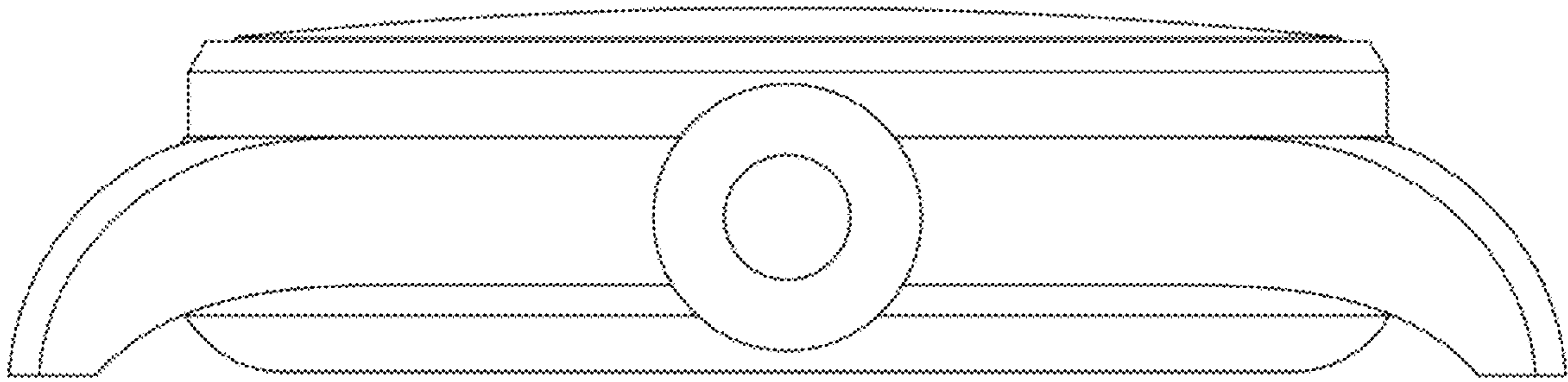



1.7

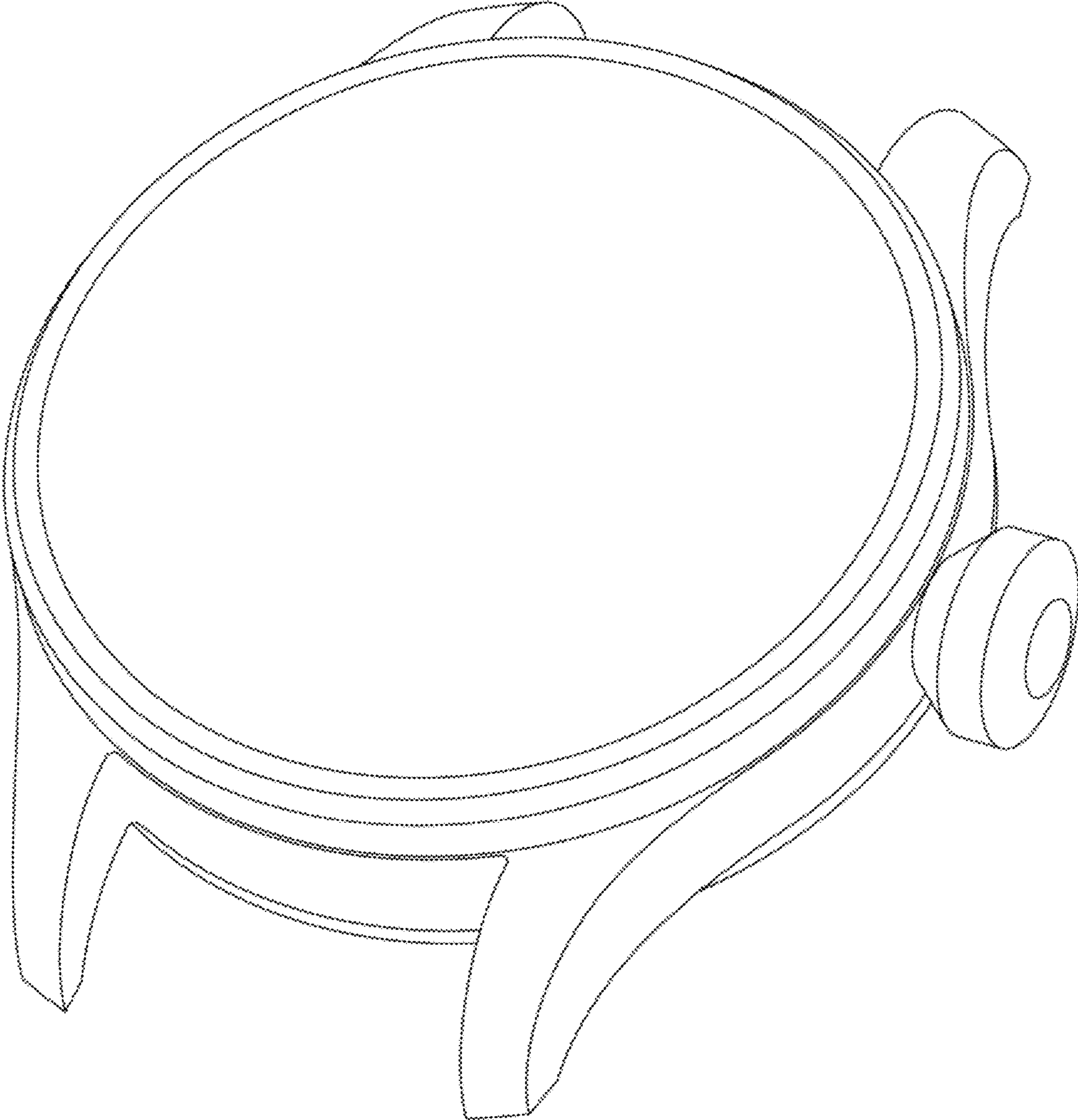



1.8

