



US00D813678S

(12) **United States Design Patent**  
**Kalagher**

(10) **Patent No.:** **US D813,678 S**

(45) **Date of Patent:** **\*\* Mar. 27, 2018**

- (54) **COOLANT ADDITIVE PACKAGE**
- (71) Applicant: **PRESTONE PRODUCTS CORPORATION**, Danbury, CT (US)
- (72) Inventor: **Thomas G. Kalagher**, Torrington, CT (US)
- (73) Assignee: **PRESTONE PRODUCTS CORPORATION**, Lake Forest, IL (US)
- (\*\*) Term: **15 Years**
- (21) Appl. No.: **29/568,788**
- (22) Filed: **Jun. 21, 2016**

- 4,859,423 A 8/1989 Perlman
- D320,469 S \* 10/1991 Hoenig ..... D28/7
- D377,293 S 1/1997 Husted
- D446,122 S 8/2001 Weinstein
- D480,590 S 10/2003 Linz
- D515,425 S 2/2006 King
- D530,968 S 10/2006 Bodum
- D539,164 S 3/2007 Decottignies

(Continued)

**FOREIGN PATENT DOCUMENTS**

- CN 2065607 U 11/1990
- WO WO 02/05399 7/2002

(Continued)

**OTHER PUBLICATIONS**

International Search Report & Written Opinion of PCT/US2015/023864 dated Jun. 17, 2015.

(Continued)

*Primary Examiner* — Ian Simmons  
*Assistant Examiner* — Keith Frank  
 (74) *Attorney, Agent, or Firm* — Barnes & Thornburg LLP; Gregory H. Zayia

**Related U.S. Application Data**

- (62) Division of application No. 29/502,697, filed on Sep. 18, 2014.
  - (51) **LOC (11) Cl.** ..... **09-01**
  - (52) **U.S. Cl.**  
USPC ..... **D9/504**
  - (58) **Field of Classification Search**  
USPC ..... D9/434, 435, 454, 500–505, 516, 558, D9/684, 686, 688, 715, 719, 737, 738, D9/740; D7/509–511, 513, 619.1, 505, D7/301.1  
CPC ..... B65D 85/816; B65D 51/1683; B65D 5/5097; B65D 2251/0018; B65D 2251/0081; B65D 51/2814; B65D 81/3227
- See application file for complete search history.

(57) **CLAIM**

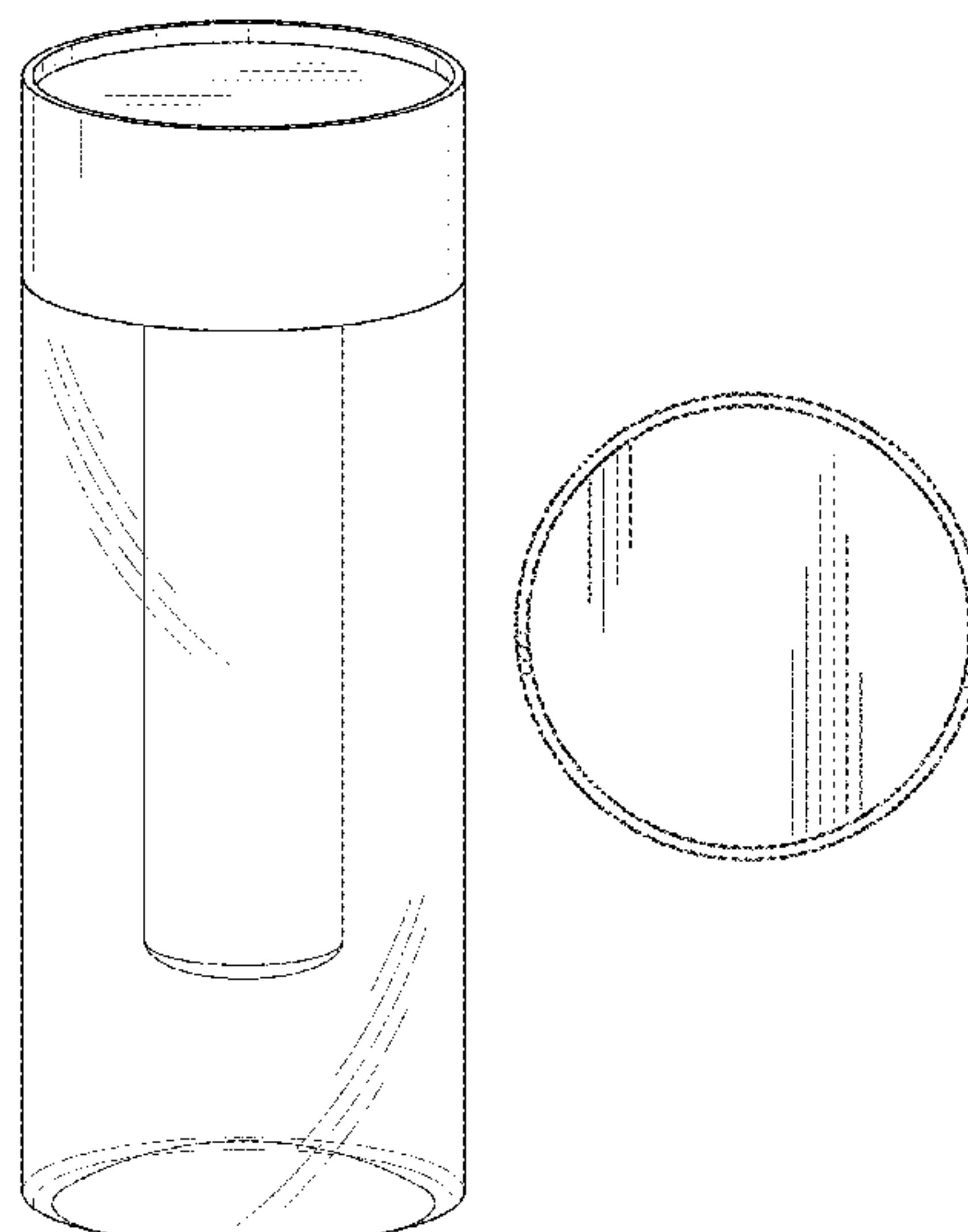
The ornamental design for a coolant additive package, as shown and described.

**DESCRIPTION**

FIG. 1 is a perspective view, taken from the front, right side, of a coolant additive package in accordance with an embodiment of my new design;  
 FIG. 2 is a front elevation view of the coolant additive package shown in FIG. 1;  
 FIG. 3 is a rear elevational view thereof;  
 FIG. 4 is a right-side elevational view thereof;  
 FIG. 5 is a left-side elevational view thereof; and,  
 FIG. 6 is a top view thereof.

**1 Claim, 4 Drawing Sheets**

- (56) **References Cited**  
U.S. PATENT DOCUMENTS
- 1,967,349 A 7/1934 Carvalho
- 2,321,998 A 6/1943 Crouch et al.
- D289,143 S 4/1987 Guillaume
- D292,881 S 11/1987 Thompson



(56)

References Cited

U.S. PATENT DOCUMENTS

D586,182 S 2/2009 Trombly  
 D610,871 S 3/2010 Alviar  
 D611,823 S \* 3/2010 Sindler ..... D9/520  
 D613,183 S \* 4/2010 Overgaard ..... D9/719  
 D613,604 S \* 4/2010 Rowland ..... D9/504  
 D621,283 S \* 8/2010 Overgaard ..... D9/719  
 D621,660 S \* 8/2010 Smiedt ..... D7/510  
 D627,604 S \* 11/2010 Eyal ..... D7/510  
 7,896,181 B1 3/2011 Francis  
 D636,275 S \* 4/2011 Stapleton ..... D9/757  
 D639,661 S \* 6/2011 Llerena ..... D9/504  
 D639,663 S \* 6/2011 Llerena ..... D9/504  
 D654,378 S 2/2012 Tucker  
 D656,041 S 3/2012 Mikolajewski  
 D671,787 S 12/2012 Lin  
 D684,805 S 6/2013 Bjerre-Poulsen  
 D690,161 S \* 9/2013 Garner ..... D7/510  
 D698,244 S \* 1/2014 Lin ..... D9/500  
 D701,727 S 4/2014 Gilbert  
 D703,052 S \* 4/2014 Park ..... D9/503  
 D703,053 S \* 4/2014 Park ..... D9/503  
 D715,156 S \* 10/2014 Park ..... D9/688  
 D716,666 S \* 11/2014 Park ..... D9/690  
 D722,113 S 2/2015 Knight  
 D729,584 S 5/2015 Weston  
 D735,514 S 8/2015 Cheung  
 9,114,910 B1 \* 8/2015 Schommer ..... B65D 77/0493  
 D739,084 S \* 9/2015 Hall ..... D28/76

D741,603 S \* 10/2015 Mehta ..... D4/116  
 D747,619 S \* 1/2016 Hampton ..... D7/316  
 D759,432 S \* 6/2016 Harris ..... D7/510  
 D760,542 S \* 7/2016 Vu ..... D7/510  
 D769,067 S \* 10/2016 Cheung ..... D7/399  
 D777,575 S \* 1/2017 Harada ..... D9/500  
 2009/0178573 A1 \* 7/2009 Pan ..... A47J 31/005  
 99/323  
 2009/0272747 A1 11/2009 Kalaouze, Jr.  
 2009/0294397 A1 12/2009 Wu  
 2011/0253745 A1 10/2011 Mainville  
 2014/0008311 A1 1/2014 Weston  
 2014/0174965 A1 6/2014 Herling  
 2015/0291312 A1 10/2015 Kalagher

FOREIGN PATENT DOCUMENTS

WO WO 2006/102472 9/2006  
 WO WO 2012/082712 6/2012

OTHER PUBLICATIONS

Office Action issued in U.S. Appl. No. 14/676,309 dated Jul. 14, 2016.  
 U.S. Appl. No. 29/502,697, filed Sep. 18, 2014.  
 Examination Report issued in App. No. EP15718037.3 (Nov. 22, 2017).  
 Search Report issued in App. No. CN201580032270.3 (Oct. 20, 2017).

\* cited by examiner

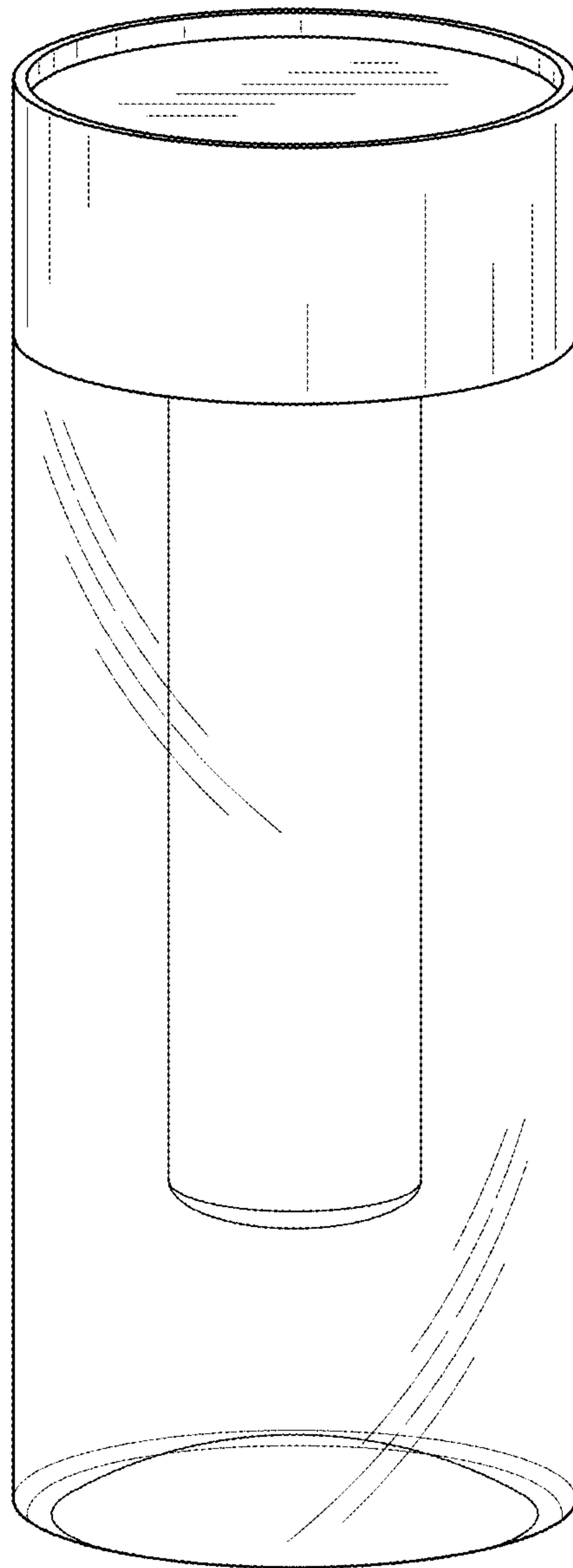
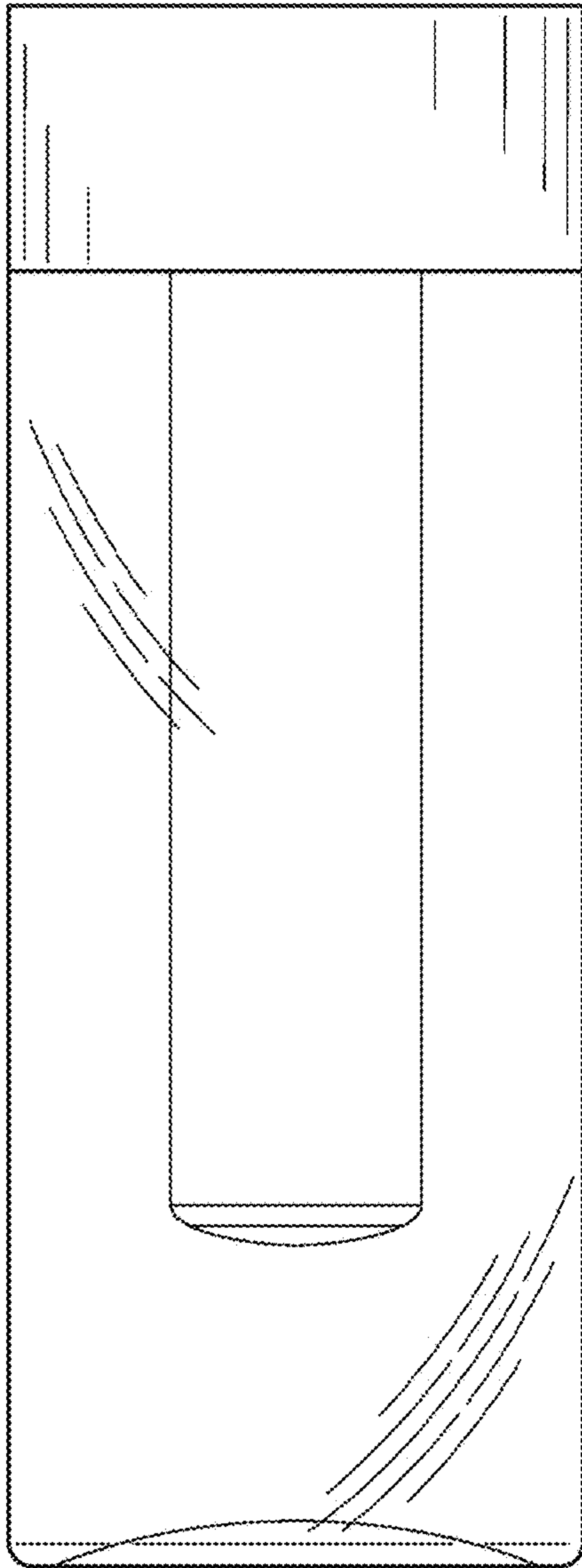
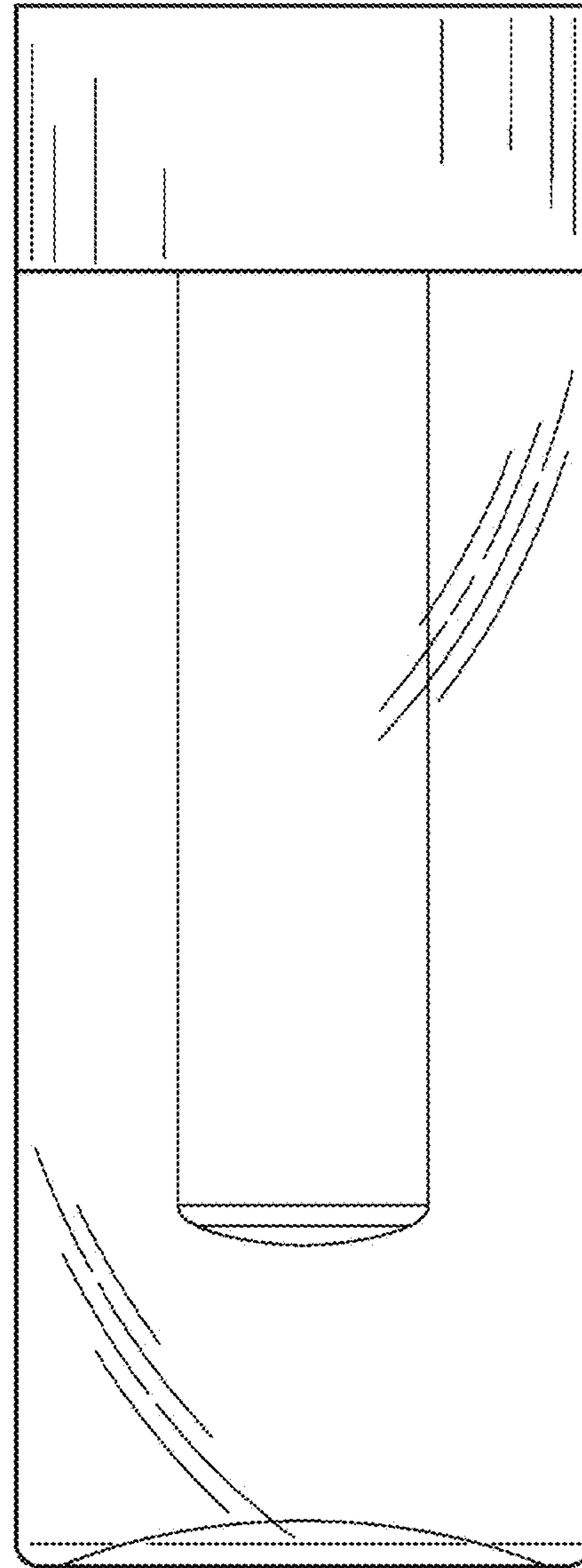


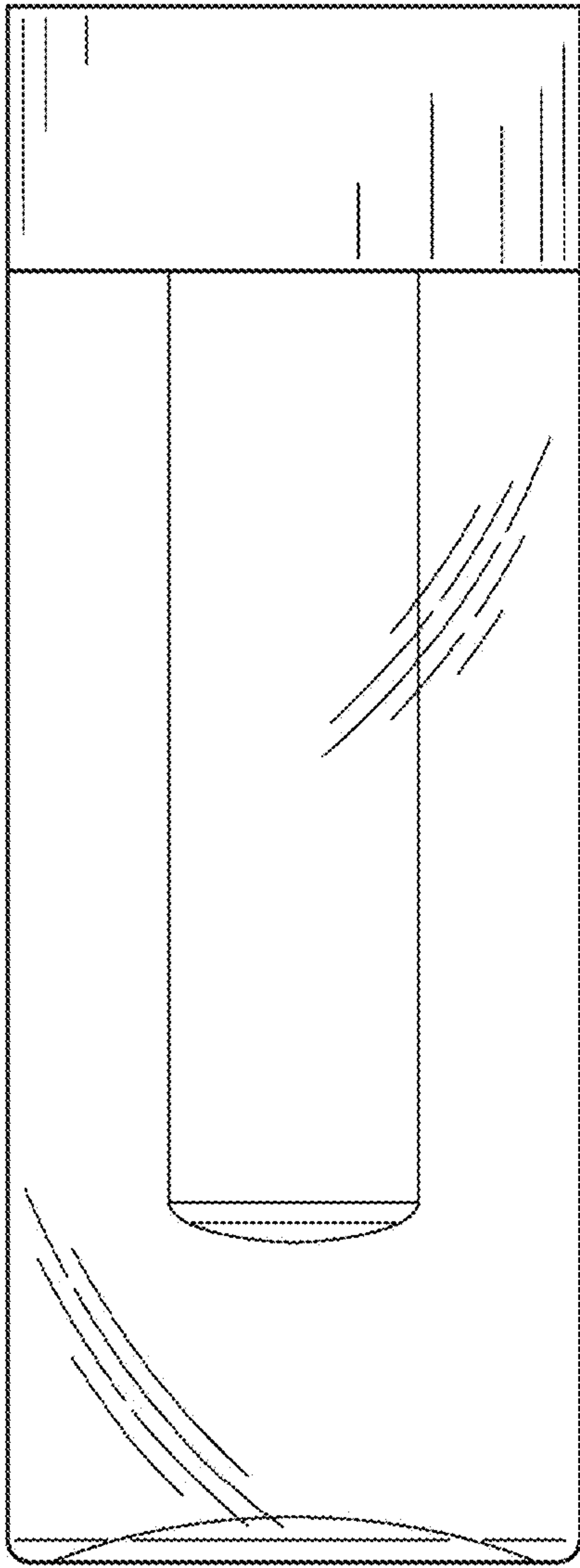
FIG 1



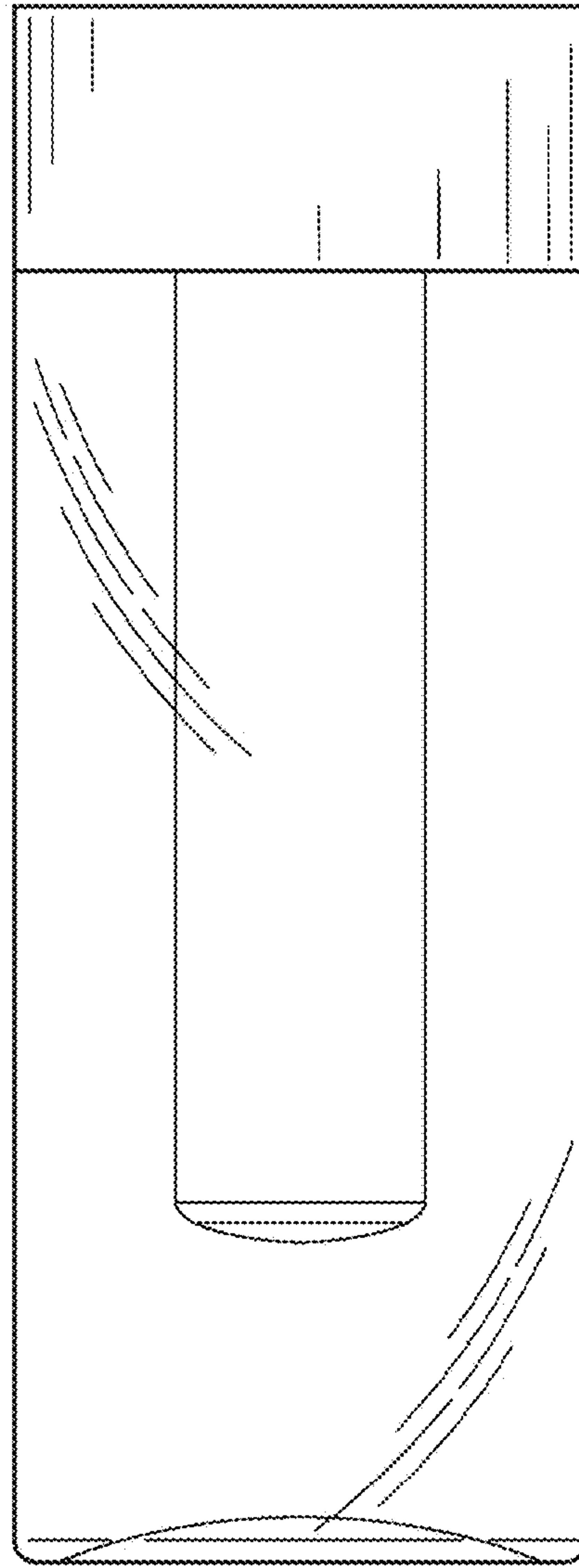
*FIG. 2*



*FIG. 3*

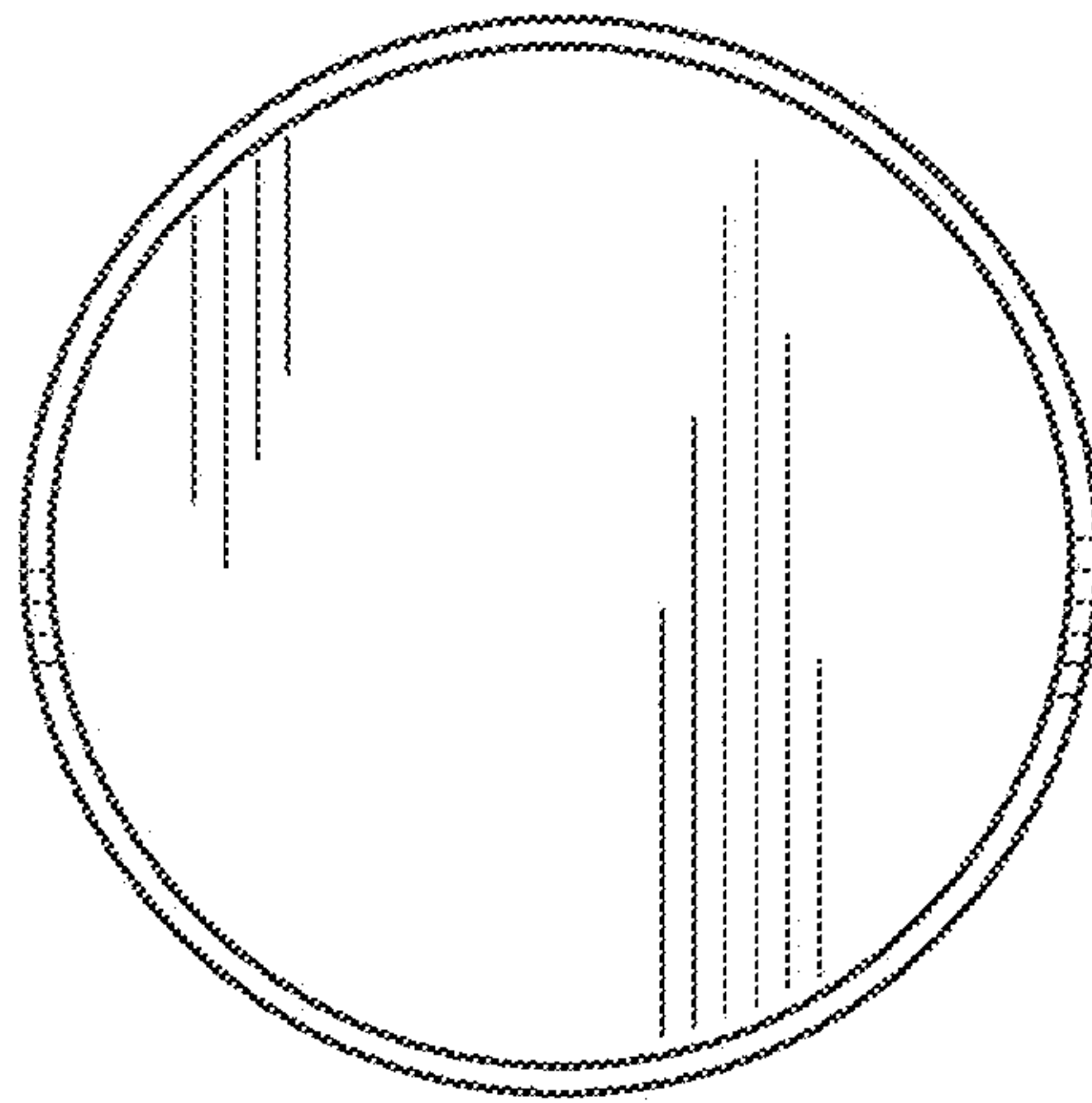


*FIG. 4*



*FIG. 5*





*FIG. 6*