



US00D813540S

(12) **United States Design Patent**
Copek et al.

(10) **Patent No.:** **US D813,540 S**
(45) **Date of Patent:** **** Mar. 27, 2018**

(54) **CARRYING CASE**

(71) Applicant: **PB Products LLC**, Almont, MI (US)

(72) Inventors: **Diane Lynn Copek**, Dryden, MI (US);
Aaron Lown, Tuxedo, NY (US);
Michael Joseph Byrne, Grand Blanc, MI (US)

(73) Assignee: **PB Products LLC**, Almont, MI (US)

(**) Term: **15 Years**

(21) Appl. No.: **29/529,302**

(22) Filed: **Jun. 5, 2015**

(51) **LOC (11) Cl.** **03-01**

(52) **U.S. Cl.**
USPC **D3/301**

(58) **Field of Classification Search**
USPC D3/234, 255, 271.9, 320, 256, 262, 279,
D3/299, 301, 303, 315, 317, 318, 319,
(Continued)

(56) **References Cited**

U.S. PATENT DOCUMENTS

D111,539 S * 9/1938 Graff D3/295
3,858,592 A 1/1975 Rickenbaker
(Continued)

FOREIGN PATENT DOCUMENTS

CN 203618952 U 6/2014
WO 2010017548 A2 2/2010
WO 2011112284 A1 9/2011

OTHER PUBLICATIONS

<http://www.layngo.com/products.php#cosmo>; accessed Aug. 22, 2013; (6 pages).

(Continued)

Primary Examiner — Sandra Snapp
Assistant Examiner — Holly E Thurman

(74) *Attorney, Agent, or Firm* — Miller Canfield Paddock and Stone; Mark L Maki

(57) **CLAIM**

We claim the ornamental design for a carrying case, as shown herein.

DESCRIPTION

FIG. 1 is a perspective view of a first embodiment of a carrying case in a closed position;
FIG. 2 is a perspective view of the first embodiment of the carrying case in an open position;
FIG. 3 is a top view of the first embodiment of the carrying case in the open position;
FIG. 4 is a front view of the first embodiment of the carrying case in the open position;
FIG. 5 is a right side view of the first embodiment of the carrying case in the open position;
FIG. 6 is a left side view of the first embodiment of the carrying case in the open position;
FIG. 7 is a rear view of the first embodiment of the carrying case in the open position;
FIG. 8 is a bottom view of the first embodiment of the carrying case in the open position;
FIG. 9 is an environmental perspective view of the first embodiment of a carrying case supported on a sink with top compartments opened;
FIG. 10 is a perspective view of a second embodiment of the carrying case in an open position;
FIG. 11 is a top view of the second embodiment of the carrying case in the open position;
FIG. 12 is a front view of the second embodiment of the carrying case in the open position;
FIG. 13 is a right side view of the second embodiment of the carrying case in the open position;
FIG. 14 is a left side view of the second embodiment of the carrying case in the open position;
FIG. 15 is a rear view of the second embodiment of the carrying case in the open position; and,
FIG. 16 is a bottom view of a second embodiment of the carrying case in the open position.

(Continued)

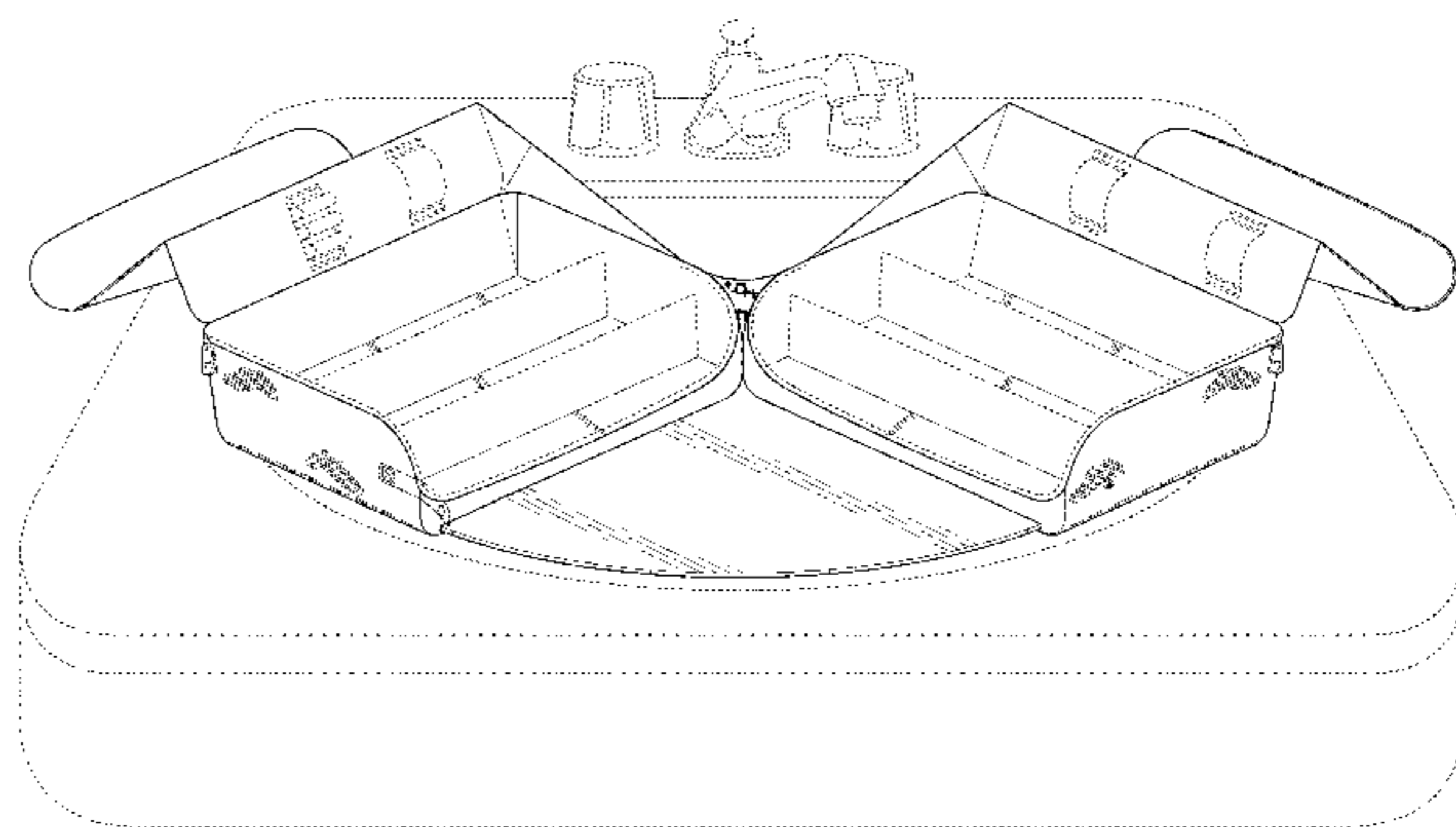
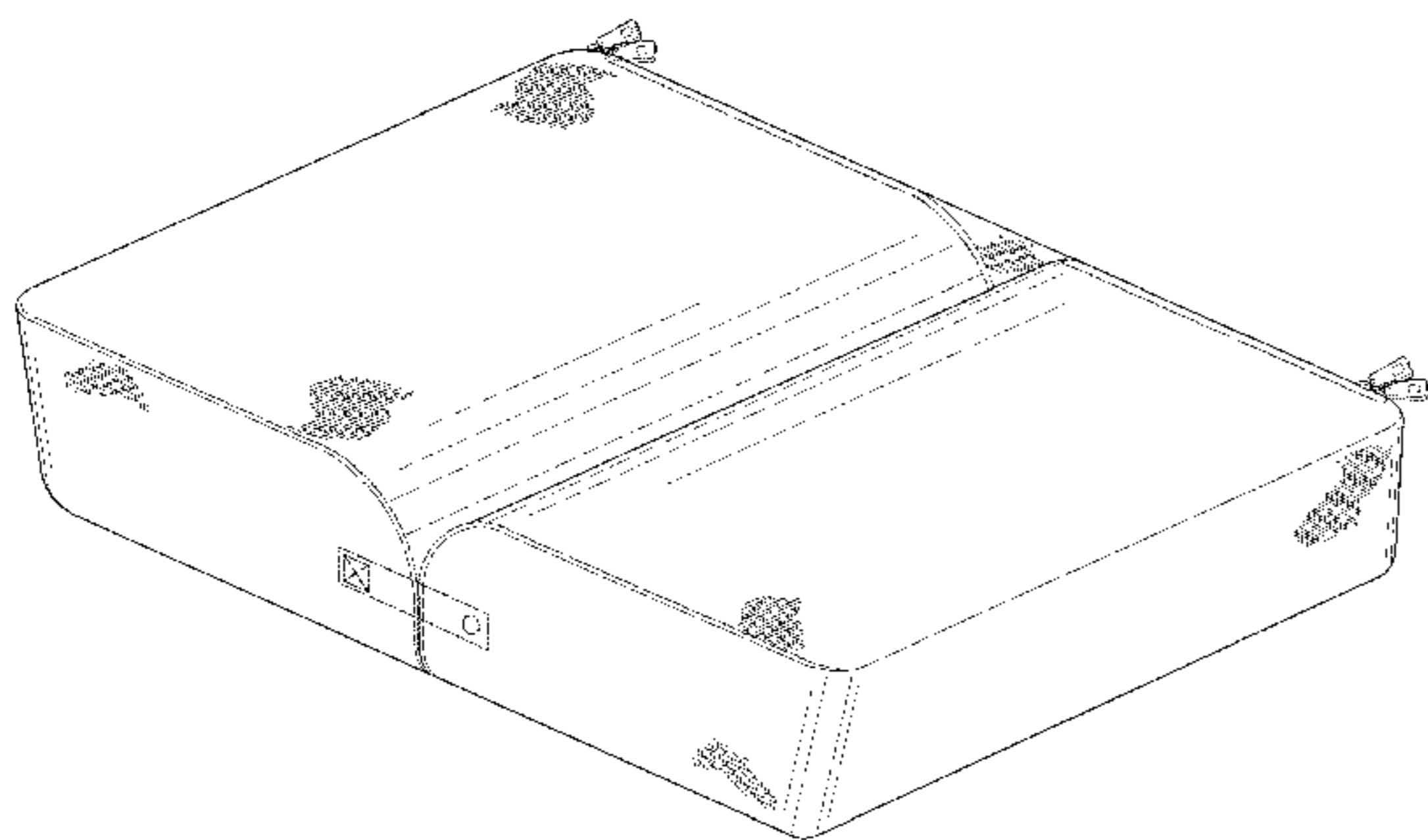

The broken lines depict portions of the carrying case and the environment that form no part of the claimed design.

1 Claim, 12 Drawing Sheets

(58) **Field of Classification Search**

USPC D3/273, 289, 292, 294–296, 232, 244;
 D9/414; D7/601, 602, 709
 CPC .. A45C 1/00; A45C 1/02; A45C 1/024; A45C
 1/08; A45C 3/00; A45C 3/10; A45C
 2003/001; A45C 2011/003; A45C 5/00;
 A45C 7/00; A45C 7/0018; A45C 7/0054;
 A45C 7/0059; A45C 7/0095; A45C
 2200/00; A45C 13/00; A45C 13/001;
 A45C 13/002; A45C 13/08; A45C 11/24;
 A45F 3/00; A45F 3/02; A45F 3/04; A45F
 3/06; A45F 2003/001; A45F 2003/002;
 A45F 2003/006; A45F 2200/00; A45F
 2200/0525

See application file for complete search history.

(56) **References Cited**

U.S. PATENT DOCUMENTS

3,989,174 A 11/1976 Norinsky
 4,580,586 A 4/1986 Kitoh et al.
 D284,424 S * 7/1986 Gotlib D3/296
 4,744,376 A 5/1988 Verducci
 D301,802 S * 6/1989 Young D3/301
 4,890,728 A 1/1990 Grimsley
 4,898,195 A 2/1990 Sussman
 4,936,463 A 6/1990 Tiramani
 5,054,505 A 10/1991 Yuhara
 D322,865 S 12/1991 Favre
 D324,453 S * 3/1992 DiSessa D3/284
 D370,123 S * 5/1996 Klinger D3/231
 5,632,394 A 5/1997 Mecca et al.
 D381,199 S * 7/1997 Glasser D3/274
 5,676,240 A 10/1997 Cziraky et al.
 5,845,658 A 12/1998 Sussman

5,862,816 A 1/1999 Lowe
 5,941,255 A 8/1999 Chen
 6,109,443 A 8/2000 Dercole
 6,138,686 A 10/2000 Yuhara
 6,378,533 B1 4/2002 Roman
 D461,046 S 8/2002 Cohen
 6,532,969 B2 3/2003 Nuzzo
 6,540,083 B2 4/2003 Shih
 6,554,001 B1 4/2003 Godshaw
 D474,889 S 5/2003 Ko
 6,640,813 B2 11/2003 Raisner et al.
 D488,928 S * 4/2004 Foley D3/283
 6,722,496 B2 4/2004 Gantert
 6,843,385 B2 1/2005 Gardi
 7,014,045 B2 3/2006 Lin
 7,040,486 B2 5/2006 Godshaw et al.
 D525,790 S * 8/2006 Heroux D3/301
 D573,793 S * 7/2008 Bakker D3/283
 7,588,146 B1 9/2009 Salander
 7,849,863 B2 12/2010 Corbellini
 D631,201 S 1/2011 Lai
 D631,202 S 1/2011 Chen
 D632,079 S * 2/2011 Spencer D3/301
 8,091,565 B2 1/2012 Ramos
 8,156,948 B2 4/2012 Gatesoupe
 D660,518 S 5/2012 Chen
 D669,270 S * 10/2012 Phillips D3/301
 8,286,646 B2 10/2012 Son
 D688,006 S 8/2013 Lai
 D690,055 S 9/2013 Chen
 D692,183 S 10/2013 Lai
 8,888,309 B1 11/2014 Foo
 D729,521 S * 5/2015 Ashry D3/299
 D754,969 S * 5/2016 Godshaw D3/299
 2005/0053312 A1 3/2005 Hankins
 2005/0247591 A1 11/2005 Peterson
 2011/0061675 A1 3/2011 McKinley

OTHER PUBLICATIONS

International Search Report and Written Opinion for PCT/US2015/
 041673 dated Oct. 9, 2015 (12 pages).
 Non-Final Office Action for U.S. Appl. No. 14/731,754 dated Mar.
 21, 2017 (32 pages).

* cited by examiner

FIG. 1

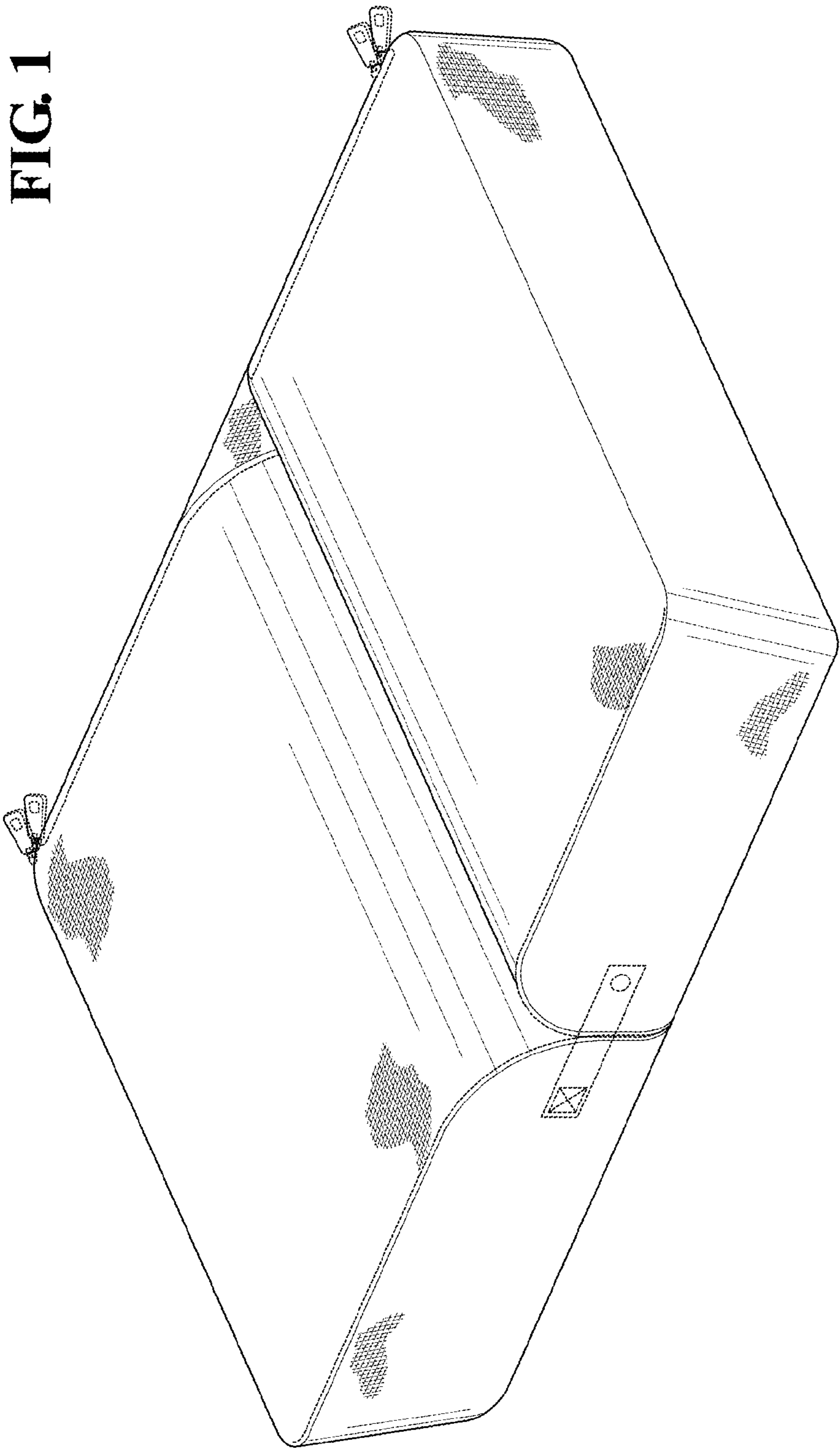

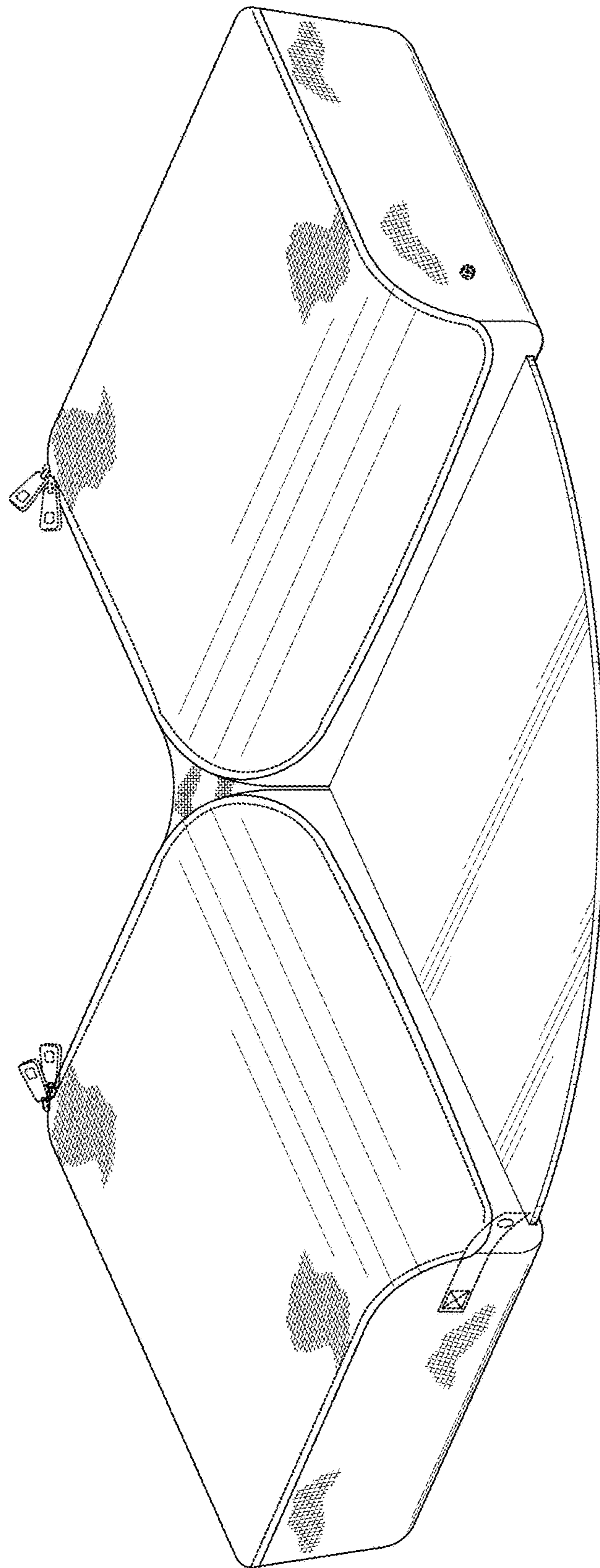

FIG. 2

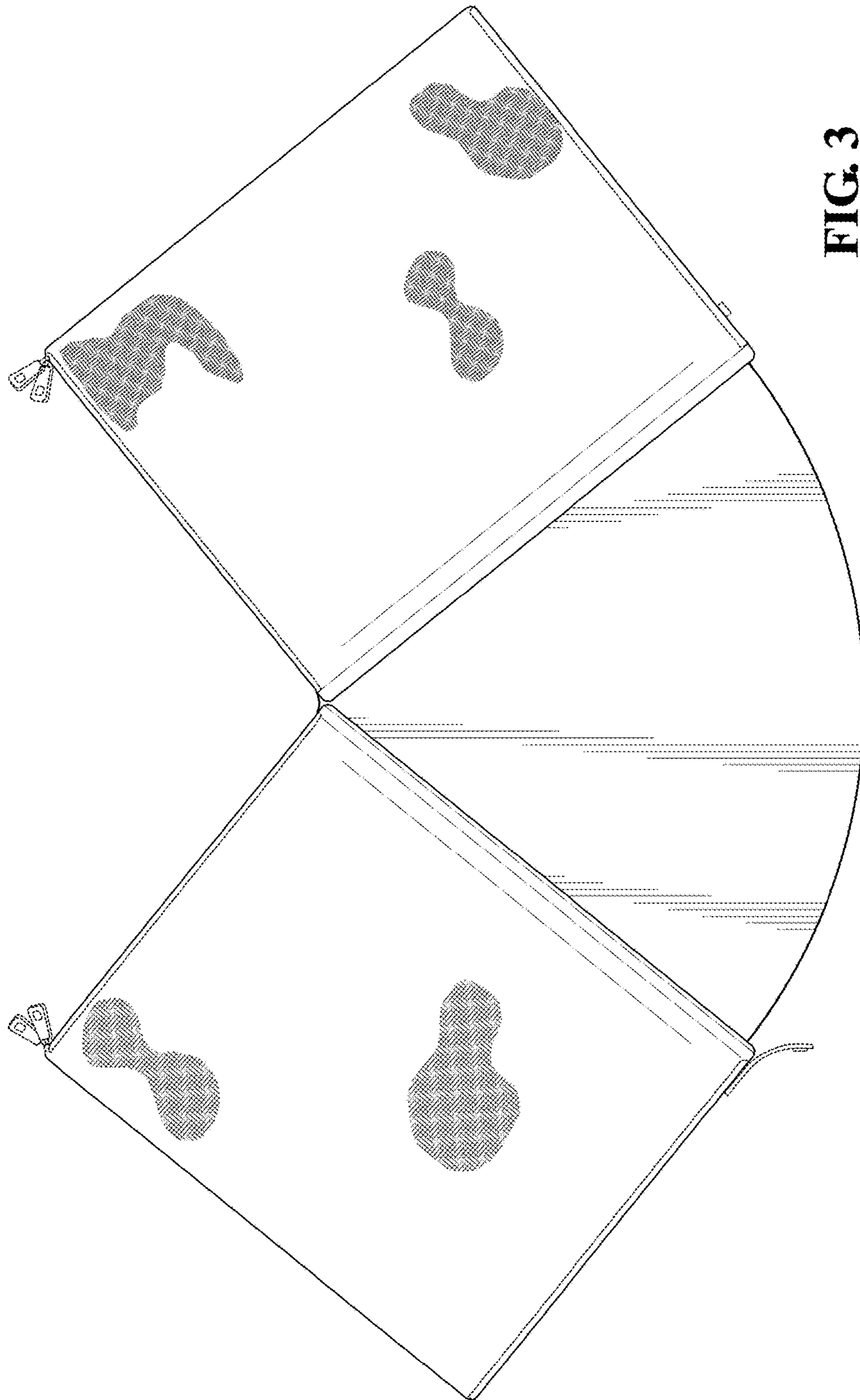

FIG. 3

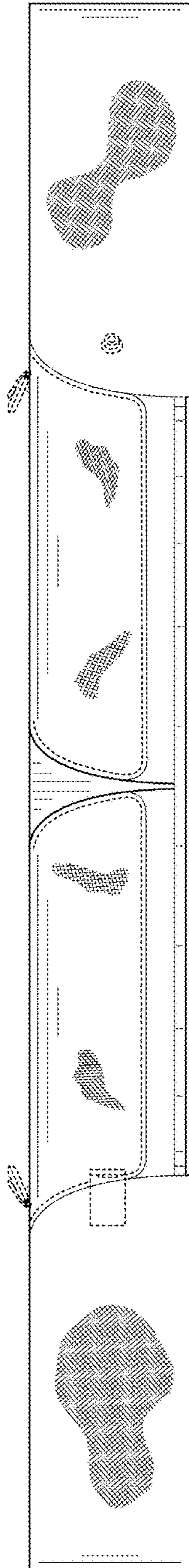

FIG. 4

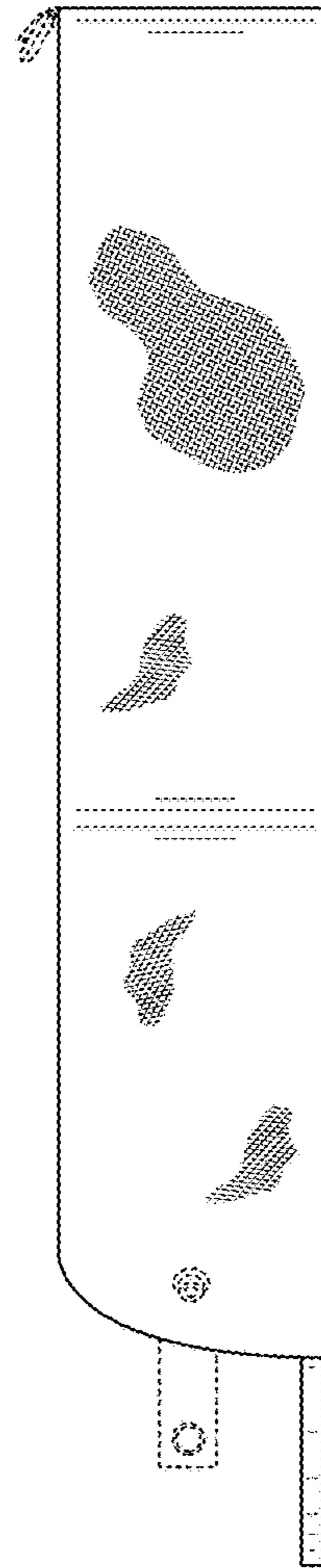

FIG. 5

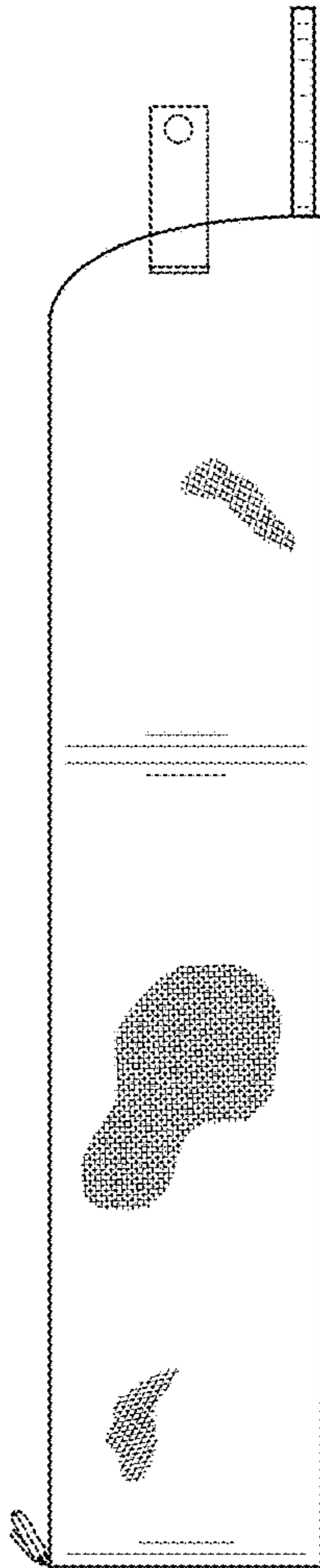

FIG. 6

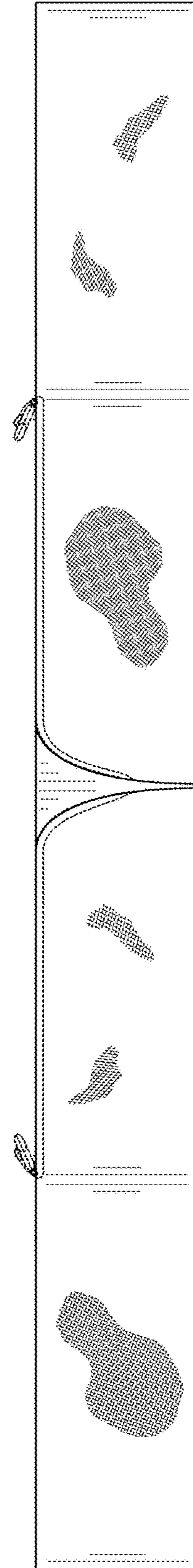

FIG. 7

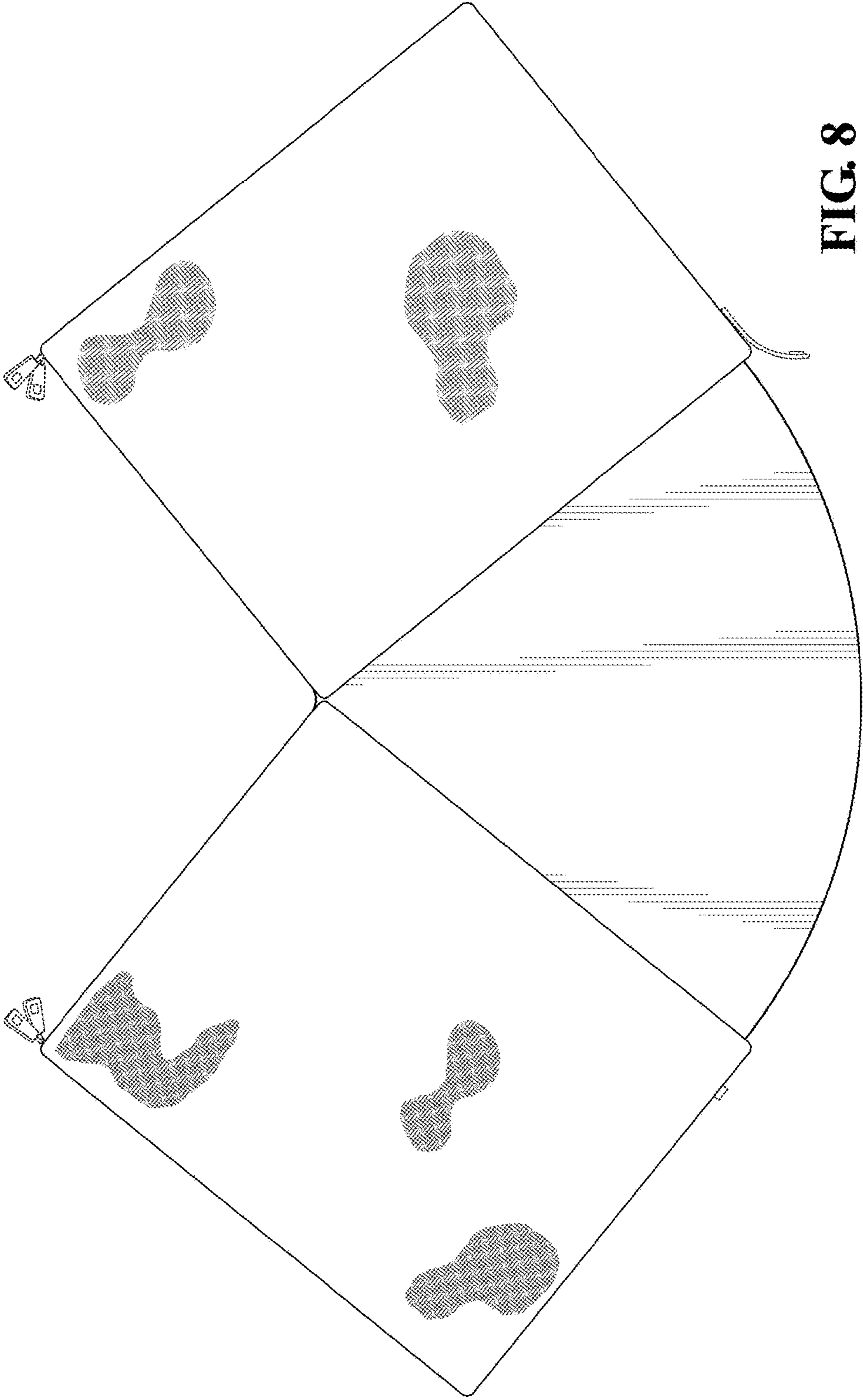

FIG. 8

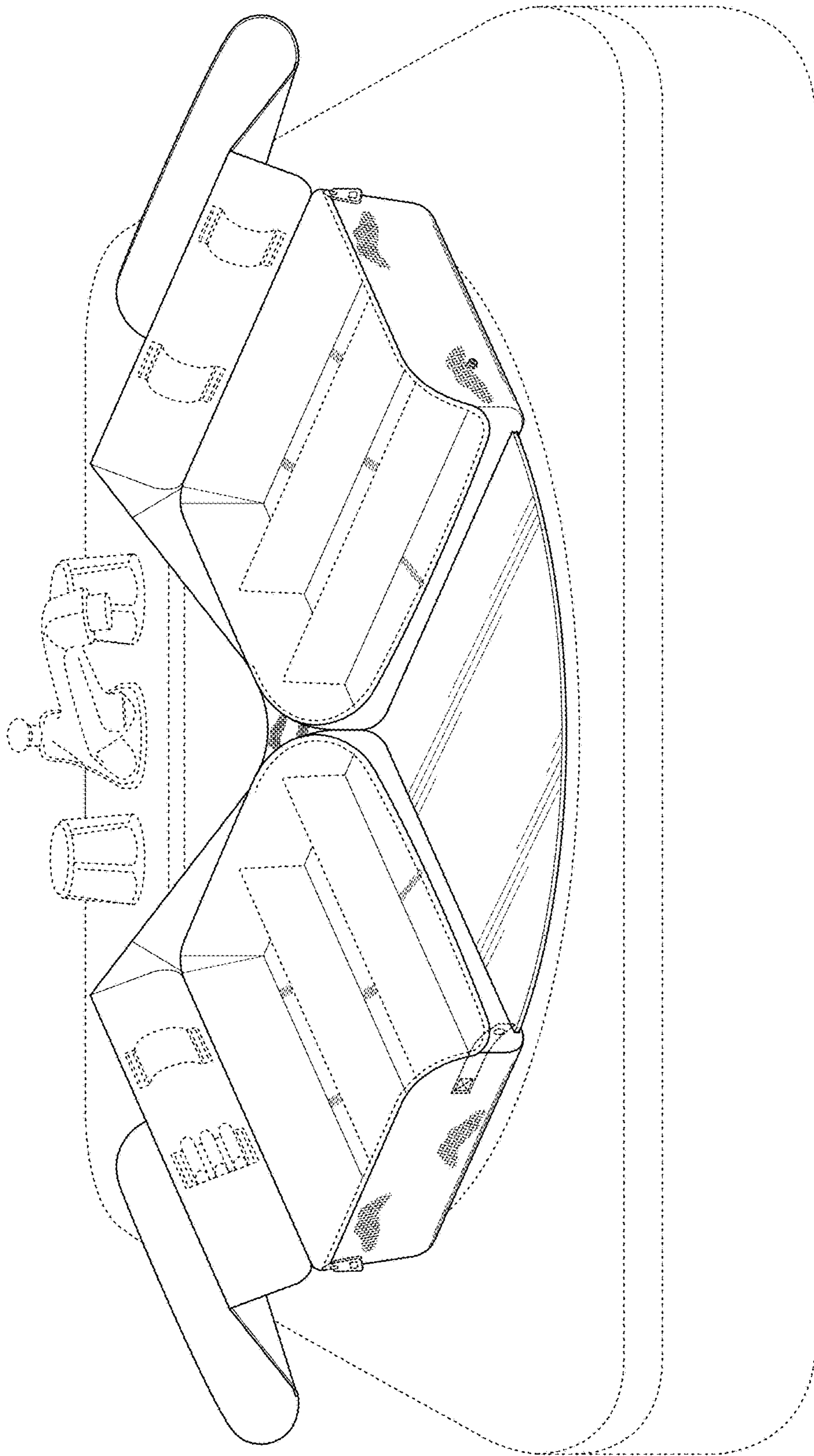

FIG. 9

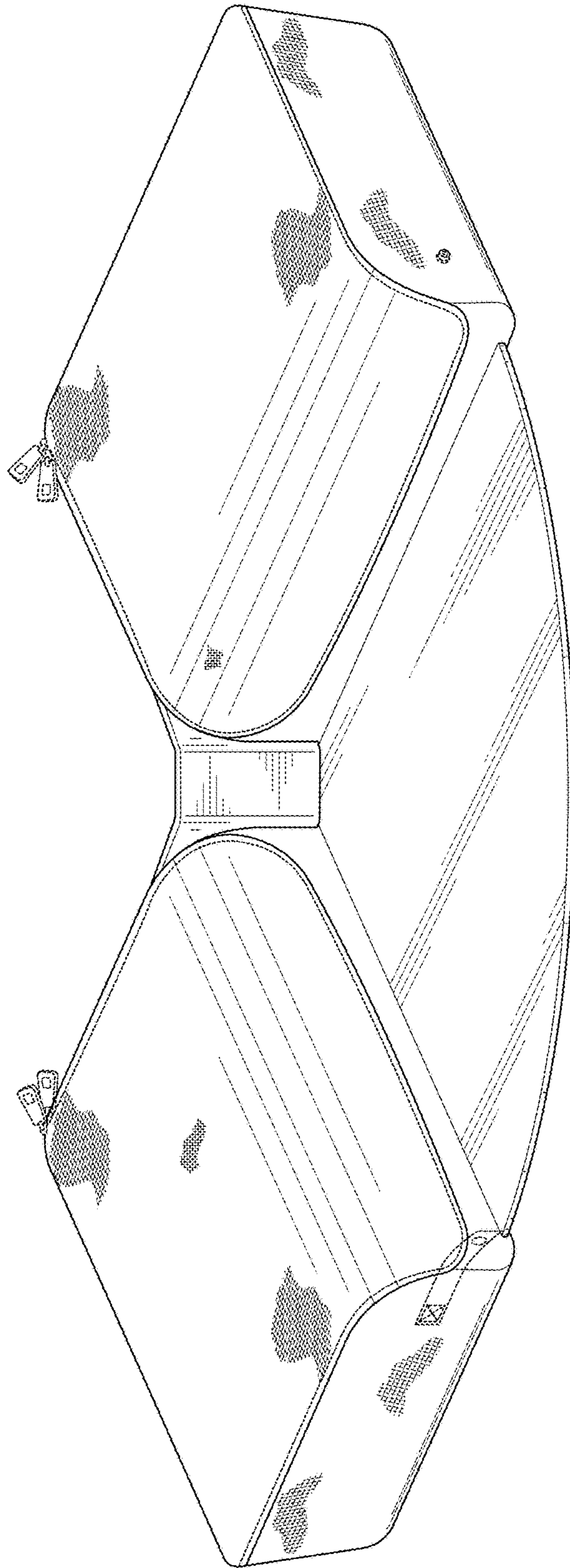

FIG. 10

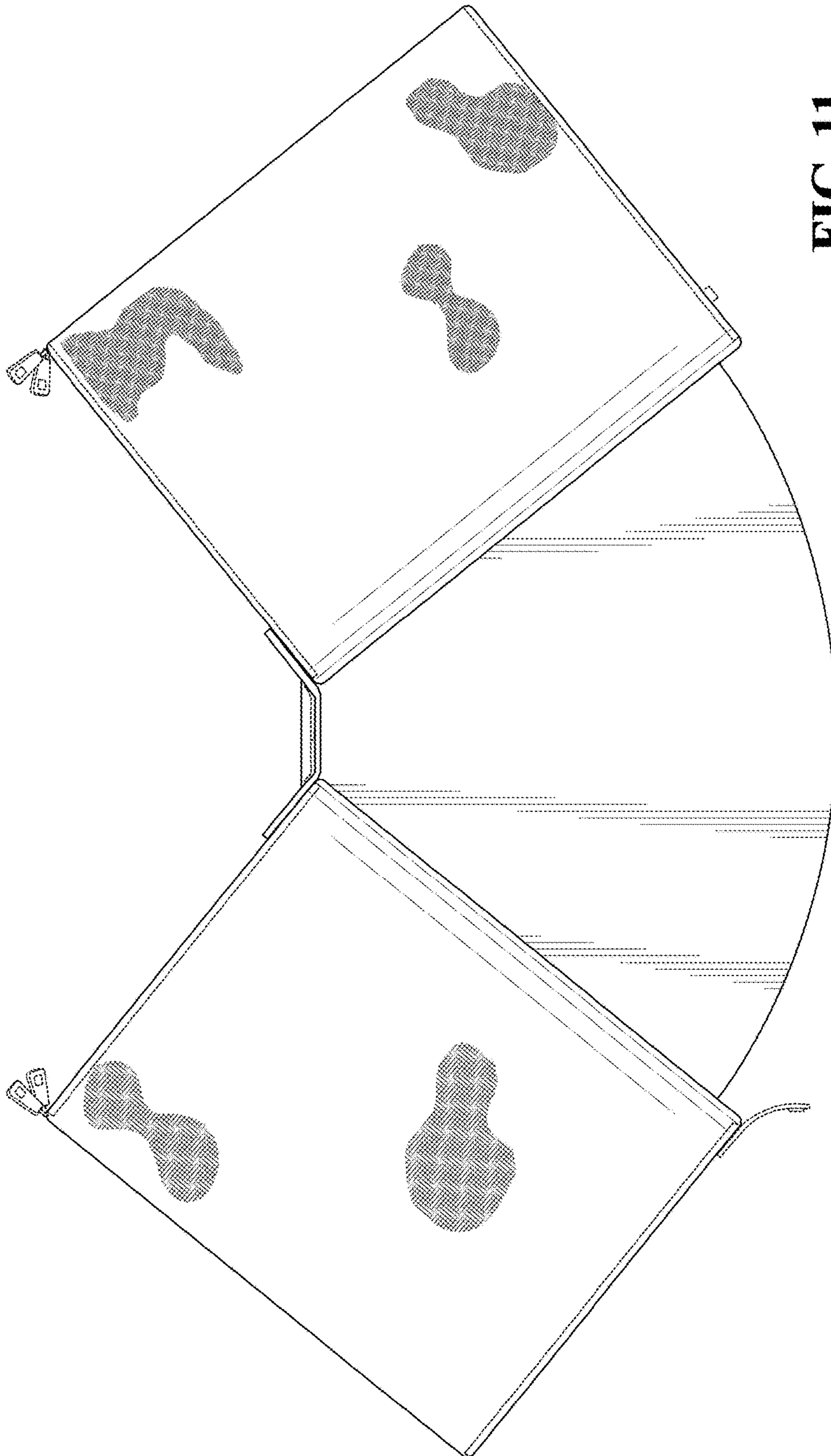

FIG. 11

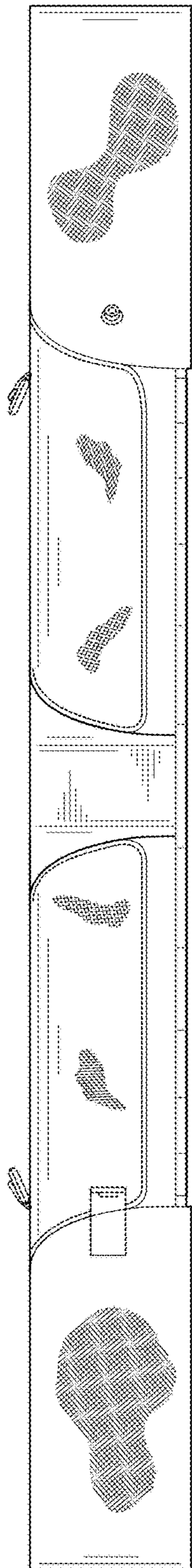

FIG. 12

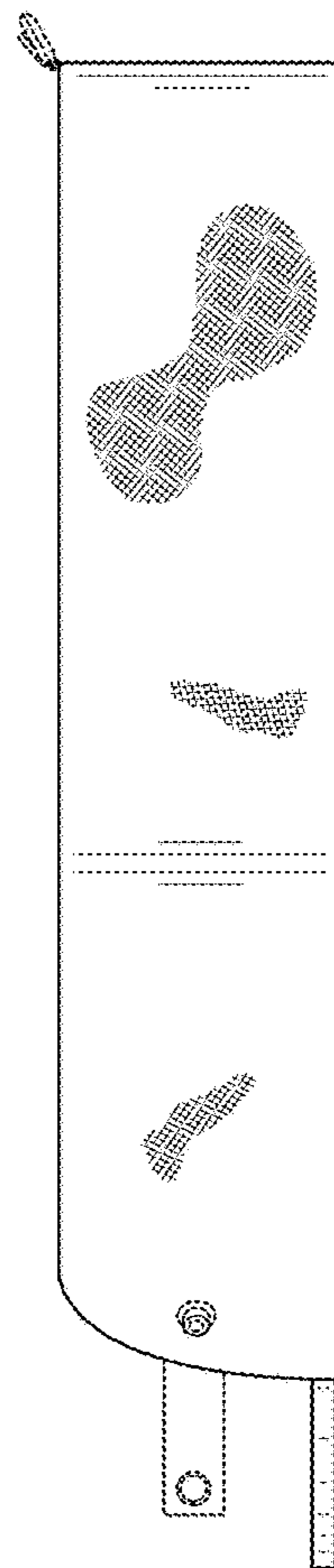

FIG. 13

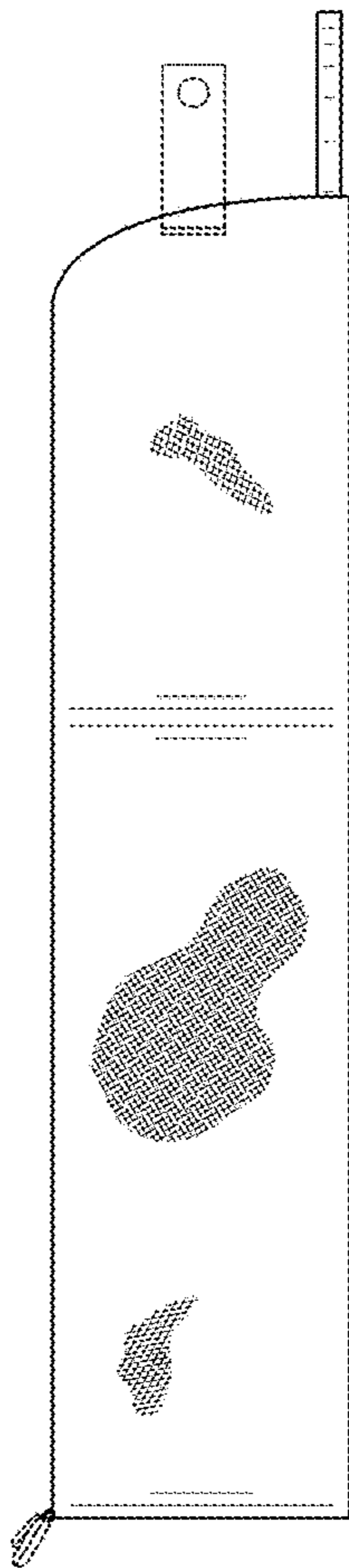

FIG. 14

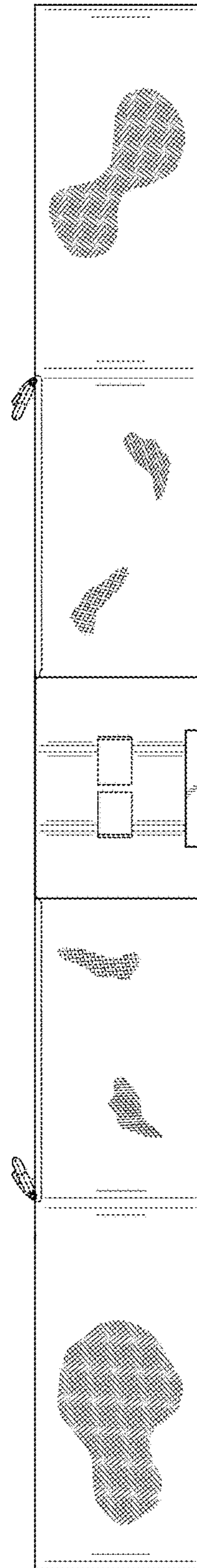

FIG. 15

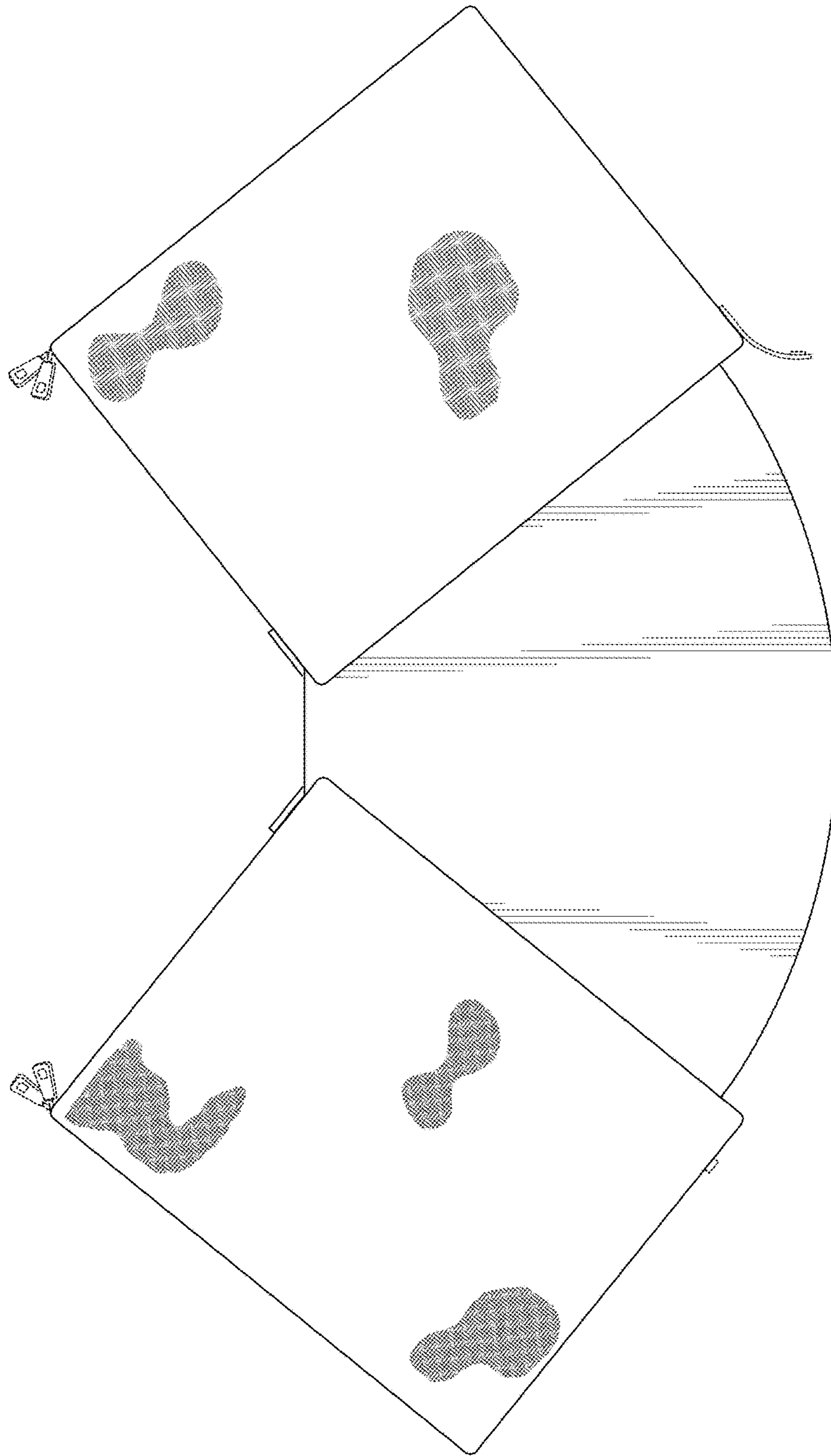

FIG. 16