



US00D813514S

(12) **United States Design Patent**
McClaskie

(10) **Patent No.:** **US D813,514 S**
(45) **Date of Patent:** **** Mar. 27, 2018**

(54) **UPPER FOR A SHOE**

(71) Applicant: **Thomas E. McClaskie**, Bethlehem, PA
(US)

(72) Inventor: **Thomas E. McClaskie**, Bethlehem, PA
(US)

(**) Term: **15 Years**

(21) Appl. No.: **29/570,289**

(22) Filed: **Jul. 7, 2016**

(51) **LOC (11) Cl.** **02-99**

(52) **U.S. Cl.**
USPC **D2/971**

(58) **Field of Classification Search**
USPC D2/896, 900, 916-18, 925-942, 969, 971
CPC A43B 21/00; A43B 21/02; A43B 21/06;
A43B 9/14; A43B 1/0045; A43B 13/10;
A43B 13/12; A43B 23/06; A43B 23/07;
A43B 1/0036; A43B 5/12; A43B 3/248;
A43B 9/02; A43B 13/122; A43B 13/14;
A43B 3/108

See application file for complete search history.

(56) **References Cited**

U.S. PATENT DOCUMENTS

D82,990 S * 1/1931 Hubbell D2/918
D95,776 S * 5/1935 Perugia D2/918

D103,223 S * 2/1937 Del Re D2/930
D103,311 S * 2/1937 Elkin D2/918
D105,227 S * 7/1937 Moore D2/932
D105,446 S * 7/1937 Troy D2/931
D106,057 S * 9/1937 Pfaeffle D2/931
D108,126 S * 1/1938 Maling D2/931
D113,241 S * 2/1939 Smith D2/918
D246,337 S * 11/1977 Niarhos D2/918

* cited by examiner

Primary Examiner — Dominic Simone

(57) **CLAIM**

The ornamental design for an upper for a shoe, as shown and described.

DESCRIPTION

FIG. 1 is a perspective view of an upper for a shoe in accordance with my new design;
FIG. 2 is a top view thereof;
FIG. 3 is a right view thereof;
FIG. 4 is a left view thereof;
FIG. 5 is a front view thereof; and,
FIG. 6 is a rear view thereof.

The broken lines shown in all of the figures are for environmental purposes and form no part of the claim.

1 Claim, 5 Drawing Sheets

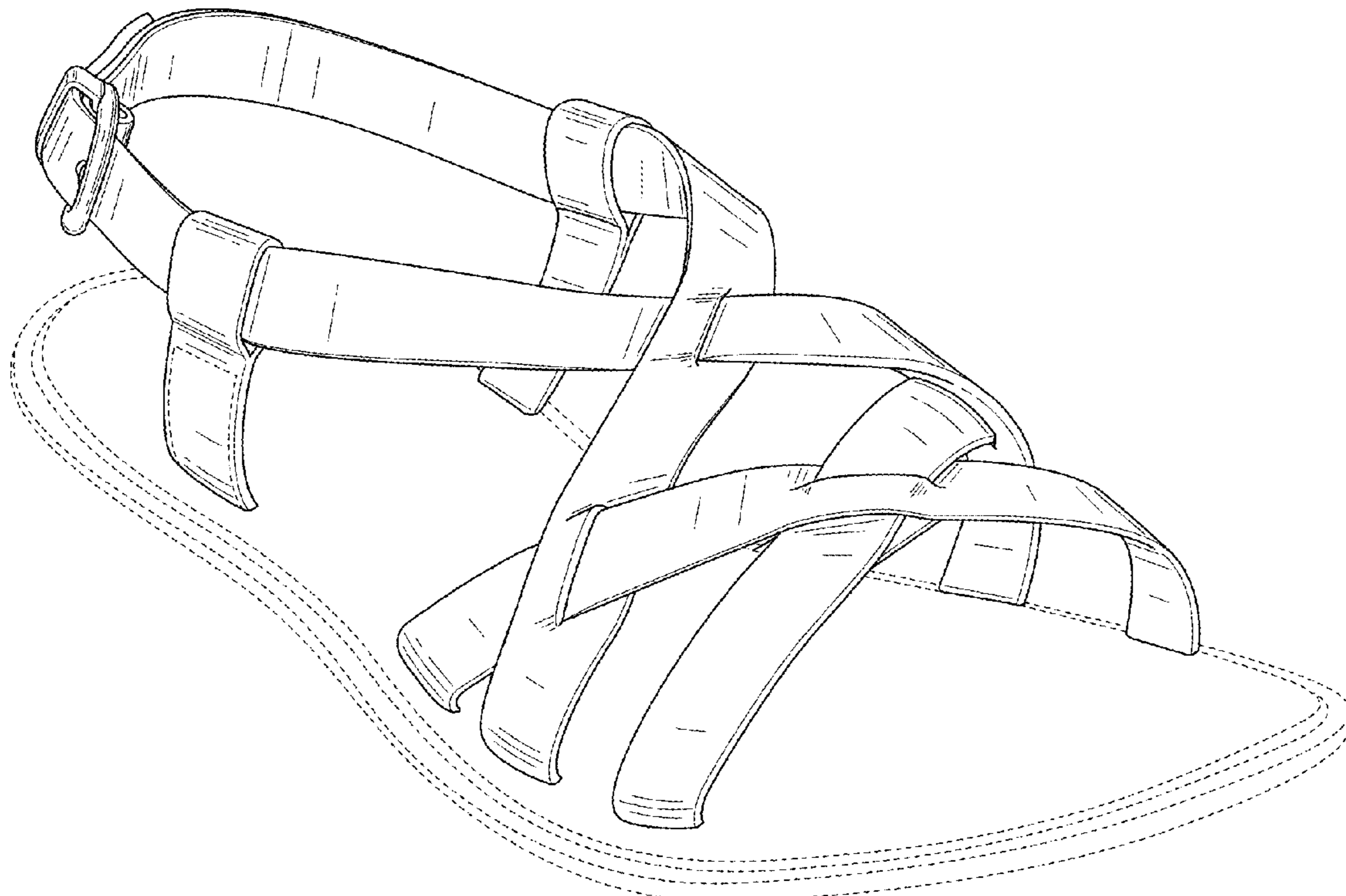

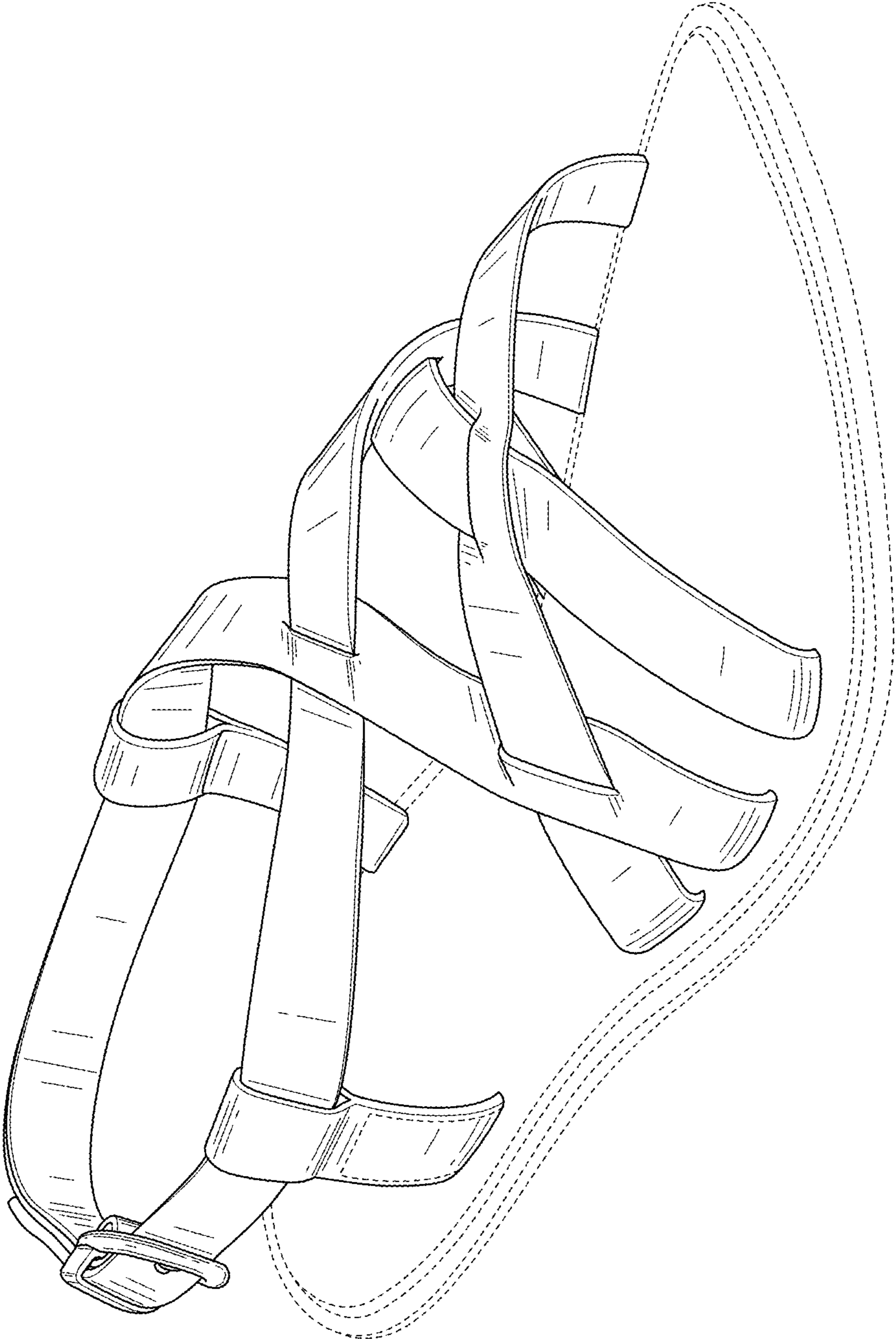

FIG. 7

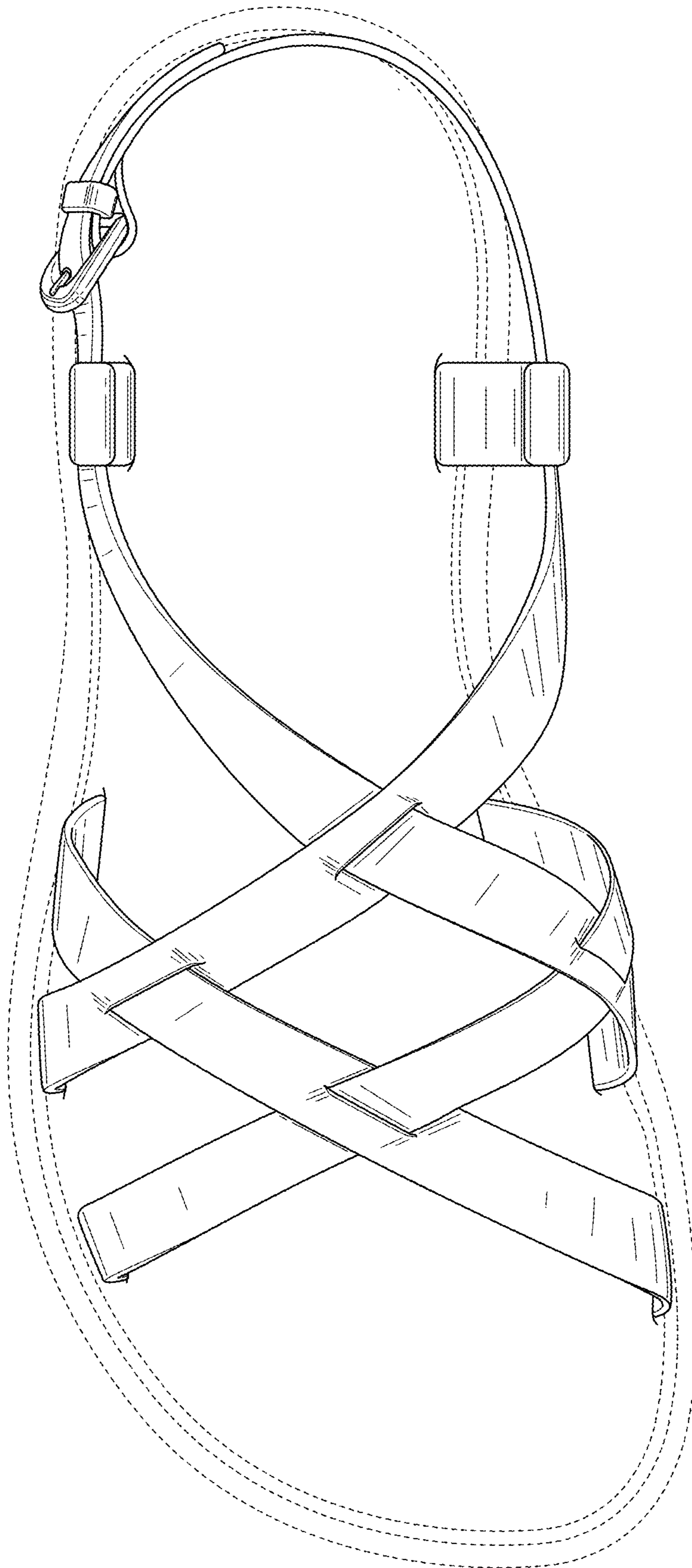

FIG. 2

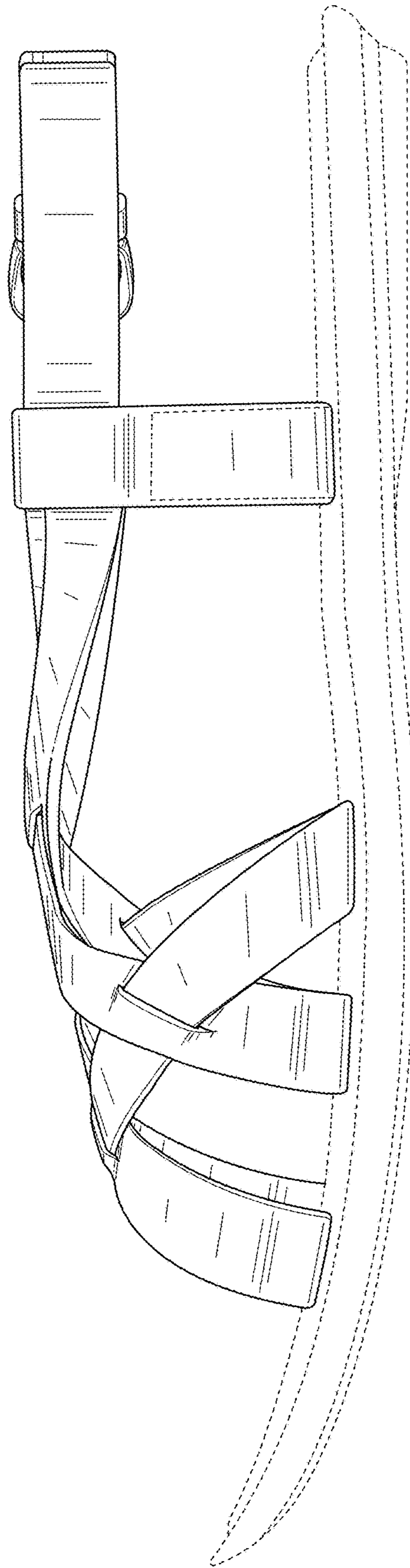

FIG. 3

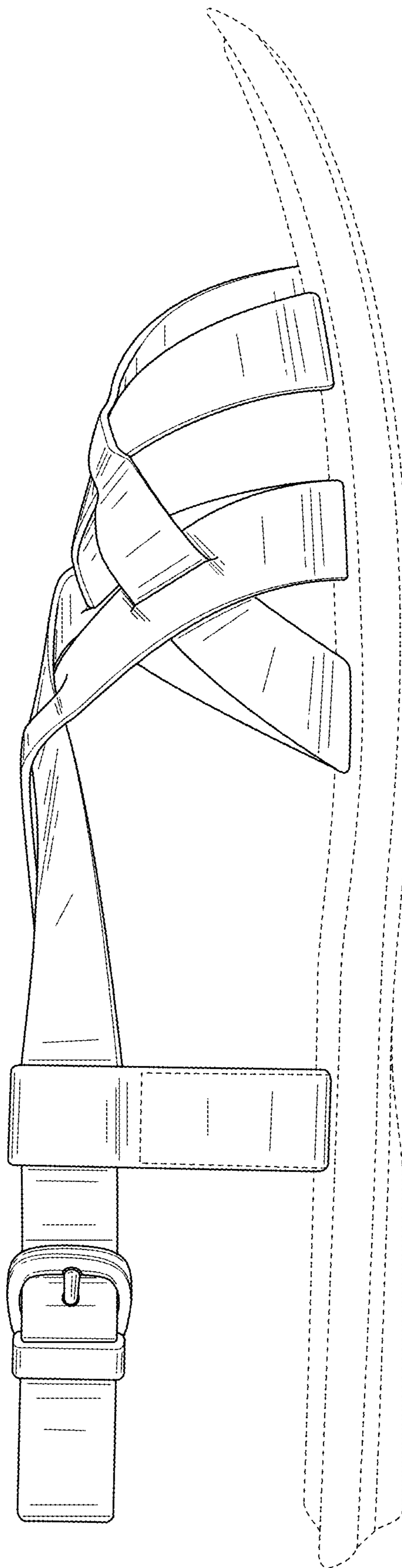

FIG. 4

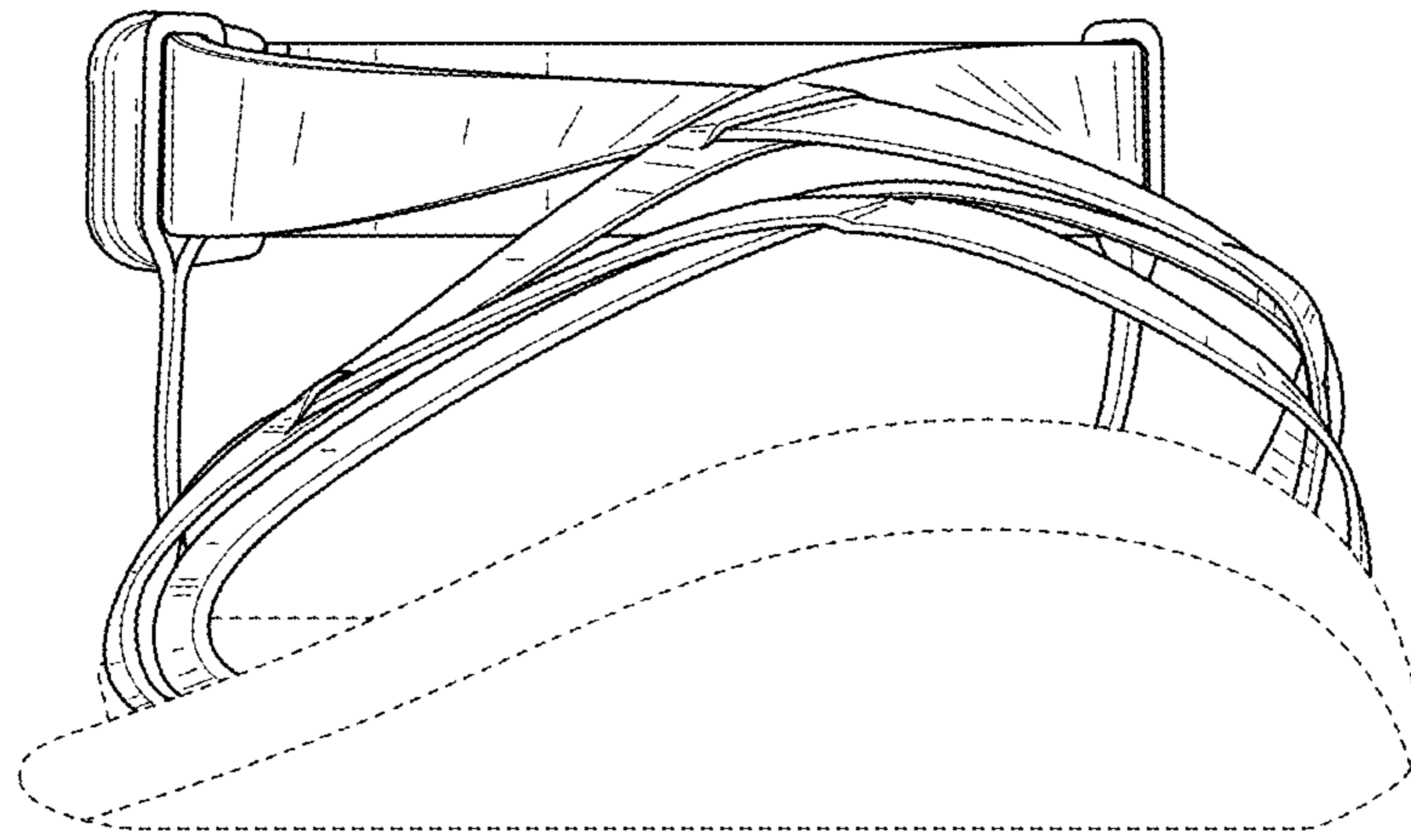

FIG. 5

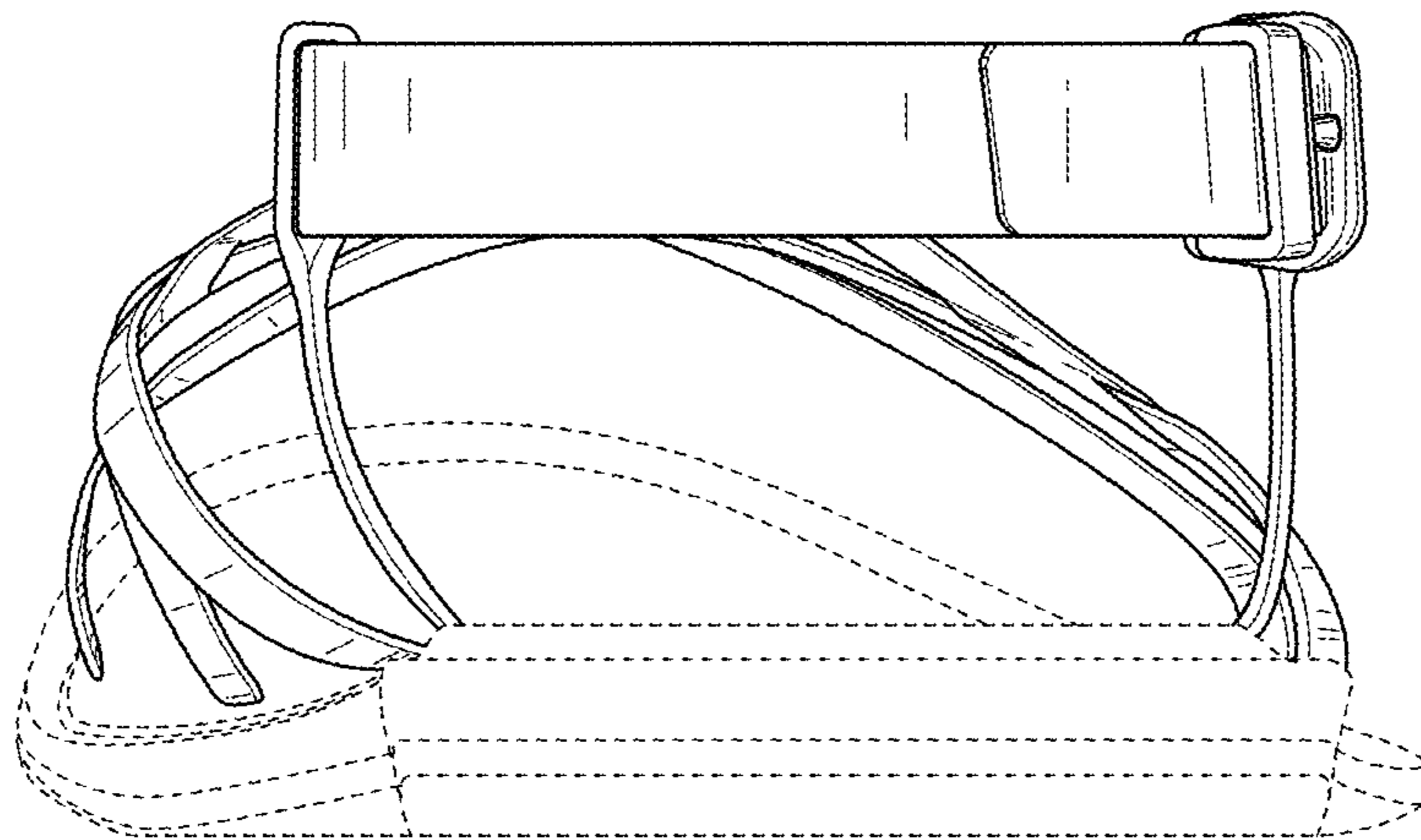

FIG. 6