



US00D813503S

(12) **United States Design Patent**
Brunner

(10) **Patent No.:** **US D813,503 S**

(45) **Date of Patent:** **** Mar. 27, 2018**

(54) **FOOTWEAR**
(71) Applicant: **ON CLOUDS GMBH**, Heiden (CH)
(72) Inventor: **Thilo Alex Brunner**, Zurich (CH)
(**) Term: **15 Years**
(21) Appl. No.: **35/501,944**
(22) Filed: **May 23, 2016**

9,565,898 B2 * 2/2017 Mahoney A43B 23/22
9,717,304 B2 * 8/2017 Bernhard A43B 13/125
D798,547 S * 10/2017 Hobson D2/908
9,775,403 B2 * 10/2017 Bernhard A43B 13/181
2005/0016023 A1 * 1/2005 Burris A43B 5/02
36/45
2012/0073160 A1 * 3/2012 Marvin A43B 13/186
36/28
2013/0152428 A1 * 6/2013 Bishop A43B 13/16
36/103
2013/0212909 A1 * 8/2013 Bates A43B 13/189
36/102
2015/0230549 A1 * 8/2015 Bernhard A43B 13/181
36/25 R

(80) **Hague Agreement Data**

Int. Filing Date: **May 23, 2016**
Int. Reg. No.: **DM/091323**
Int. Reg. Date: **May 23, 2016**
Int. Reg. Pub. Date: **Nov. 25, 2016**

* cited by examiner

Primary Examiner — George D Kirschbaum

Assistant Examiner — Jennifer Watkins

(51) **LOC (11) Cl.** **02-04**
(52) **U.S. Cl.**
USPC **D2/908**

(57) **CLAIM**

The ornamental design for footwear, as shown and described.

(58) **Field of Classification Search**
USPC D2/896, 902, 905, 906, 907, 908, 943,
D2/944, 945, 947, 951, 960, 972
CPC ... A43B 13/141; A43B 23/0235; A43B 13/16;
A43B 13/181; A43B 13/184; A43B
13/187; A43B 13/188
See application file for complete search history.

DESCRIPTION

- 1. Footwear
- 1.1 : Perspective
- 1.2 : Perspective
- 1.3 : Back
- 1.4 : Top
- 1.5 : Left
- 1.6 : Right
- 1.7 : Bottom
- 1.8 : Front

(56) **References Cited**

U.S. PATENT DOCUMENTS

D628,778 S * 12/2010 Hardy D2/908
D671,718 S * 12/2012 McVicker D2/908
9,320,317 B2 * 4/2016 Bernhard A43B 13/181

1 Claim, 8 Drawing Sheets

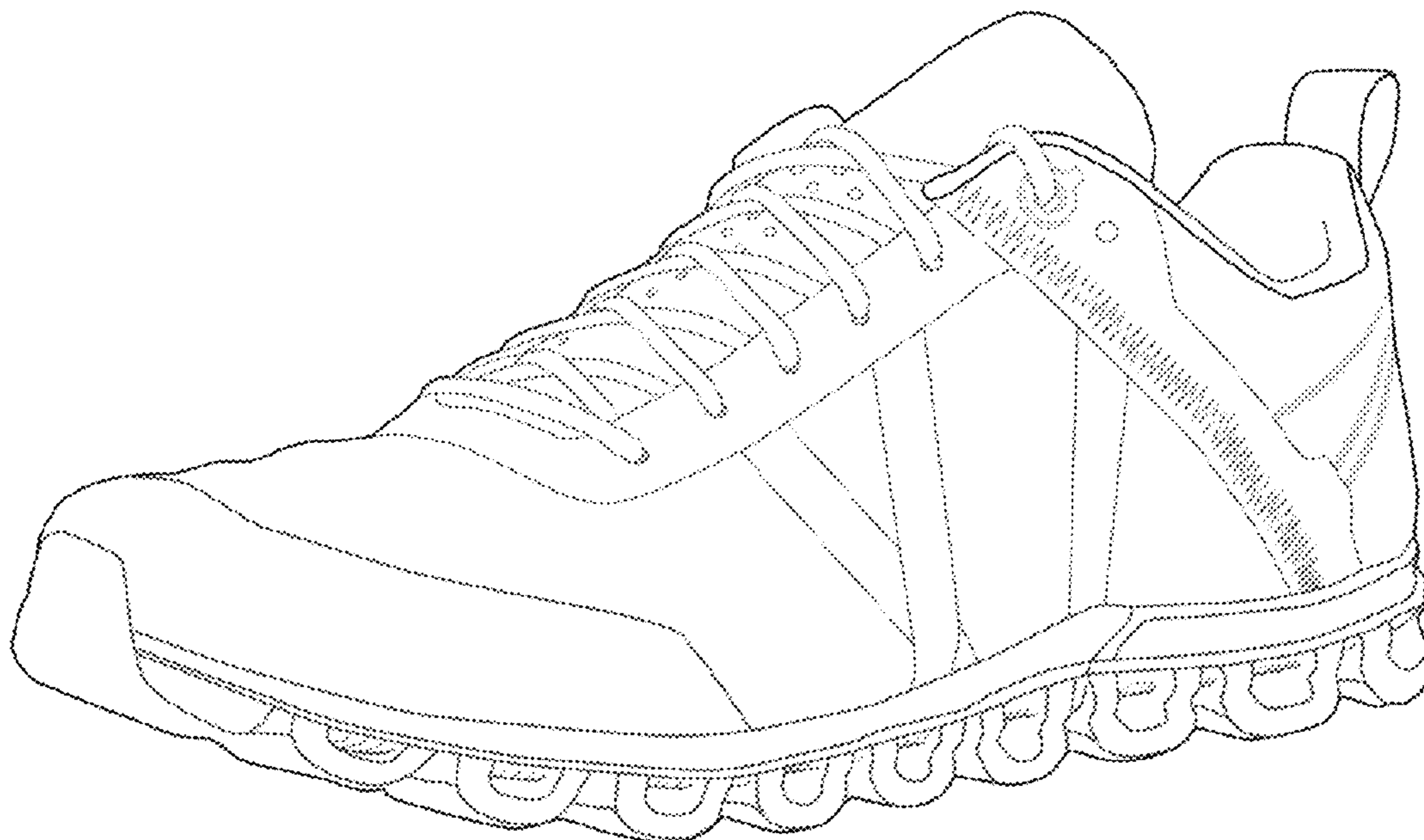

1.1

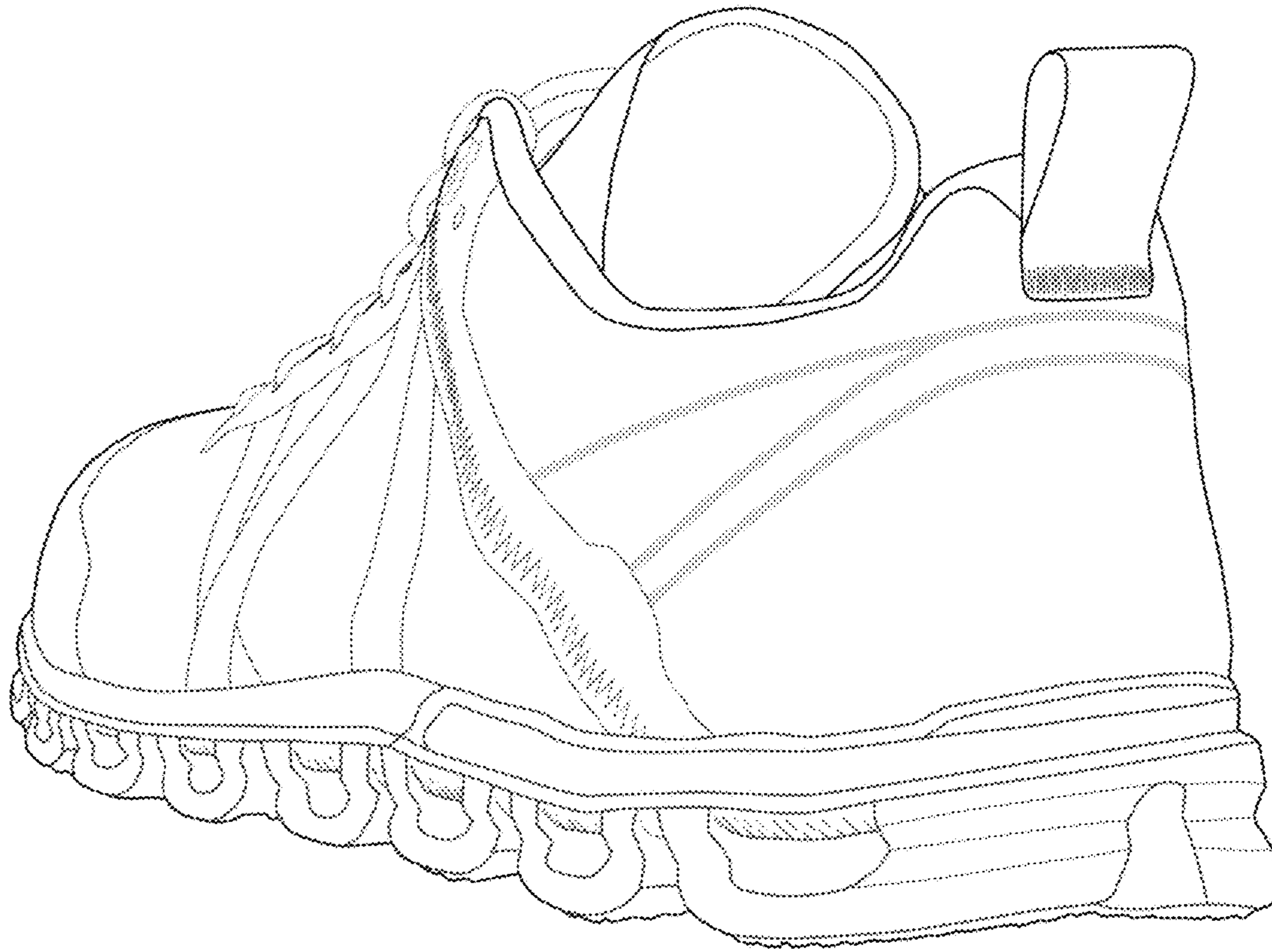

1.2

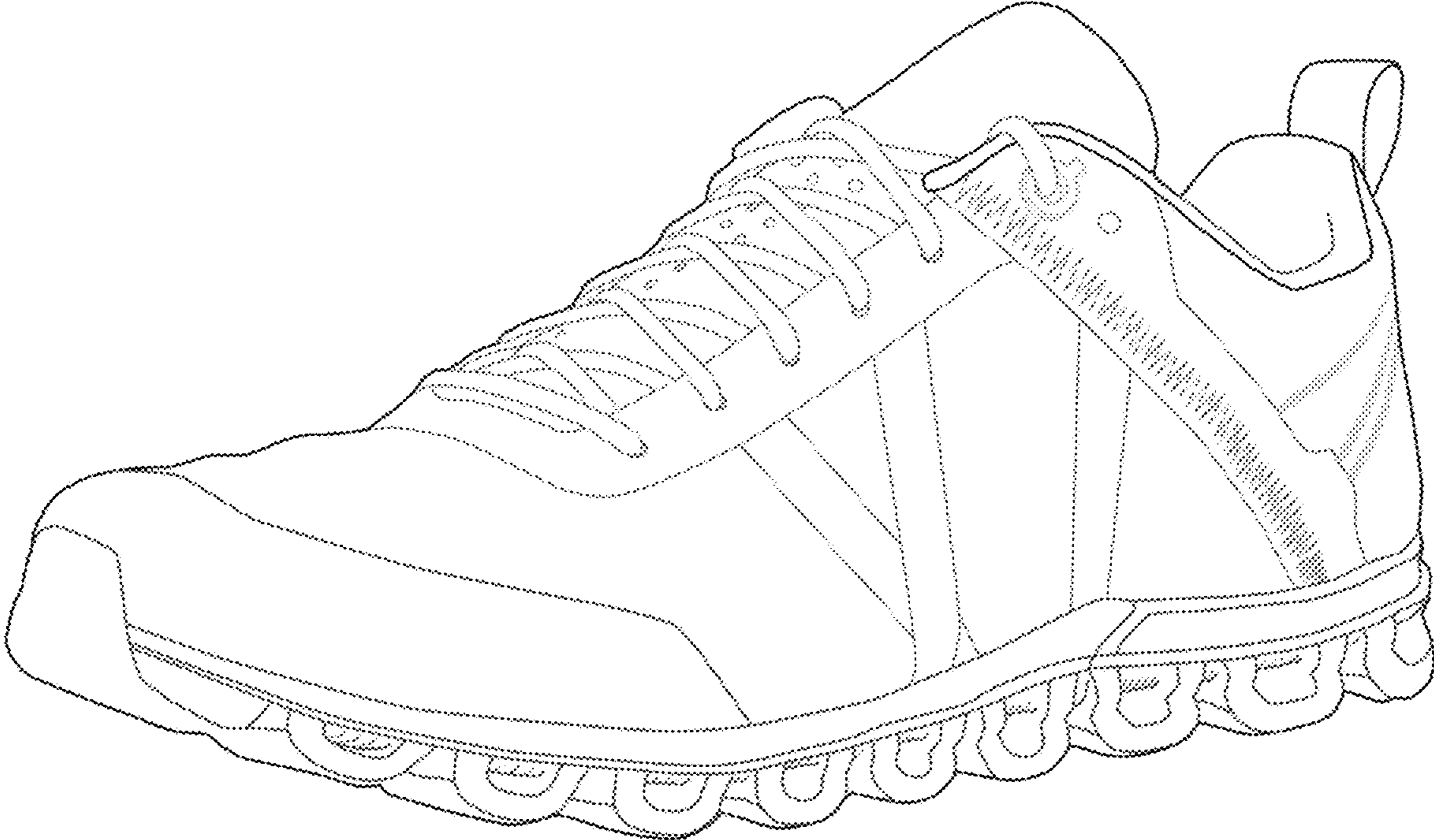

1.3

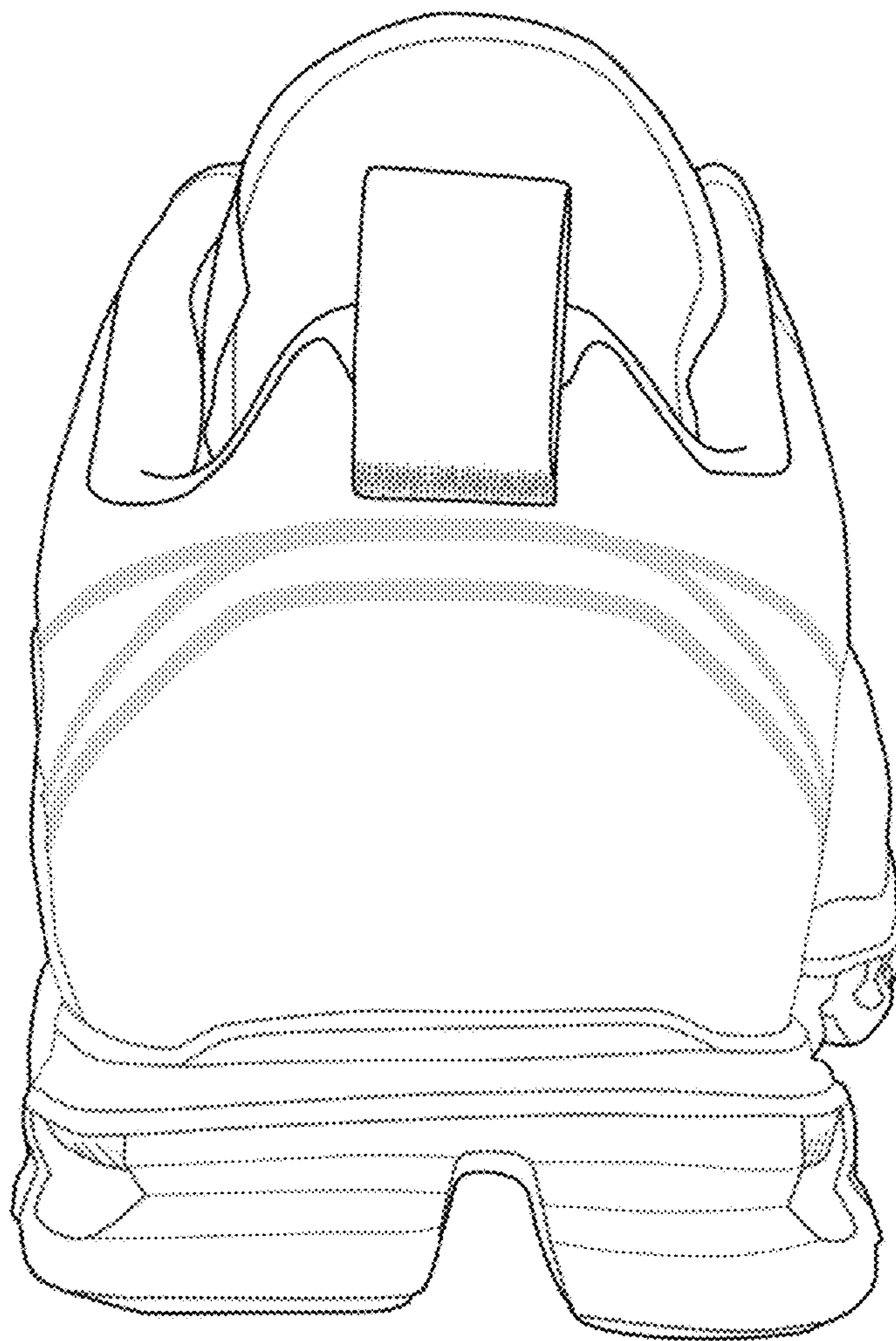

1.4

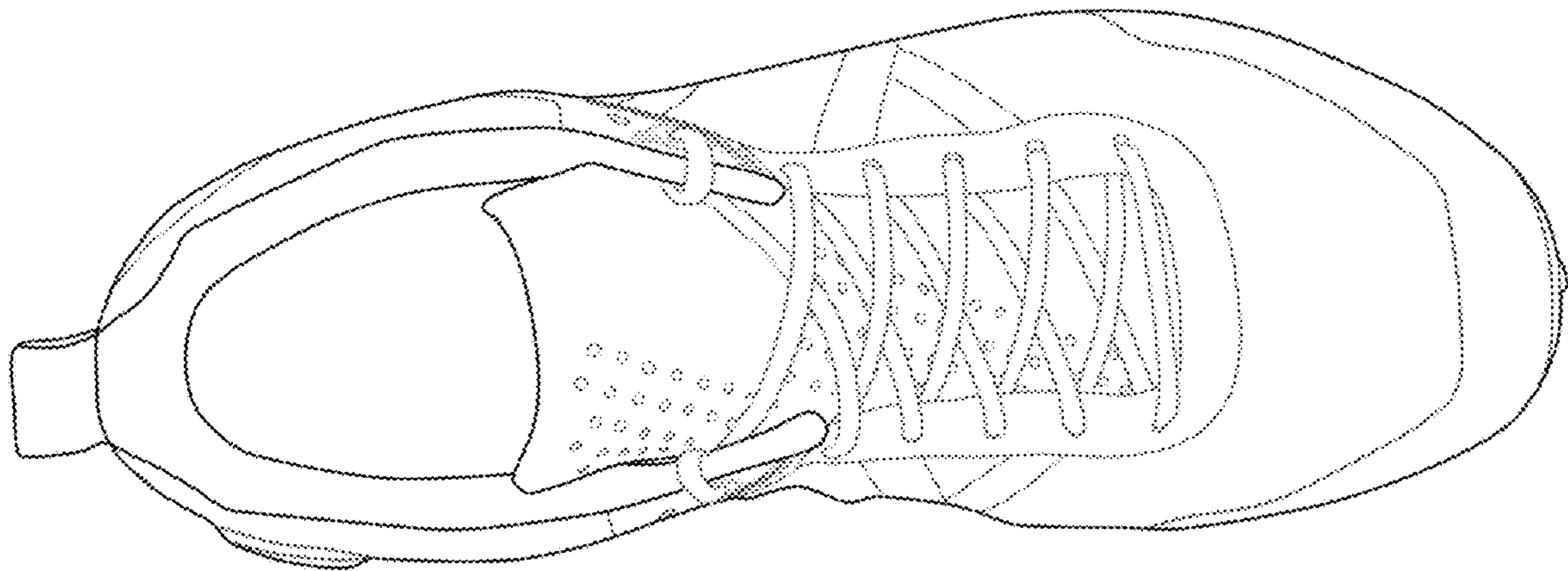

1.5

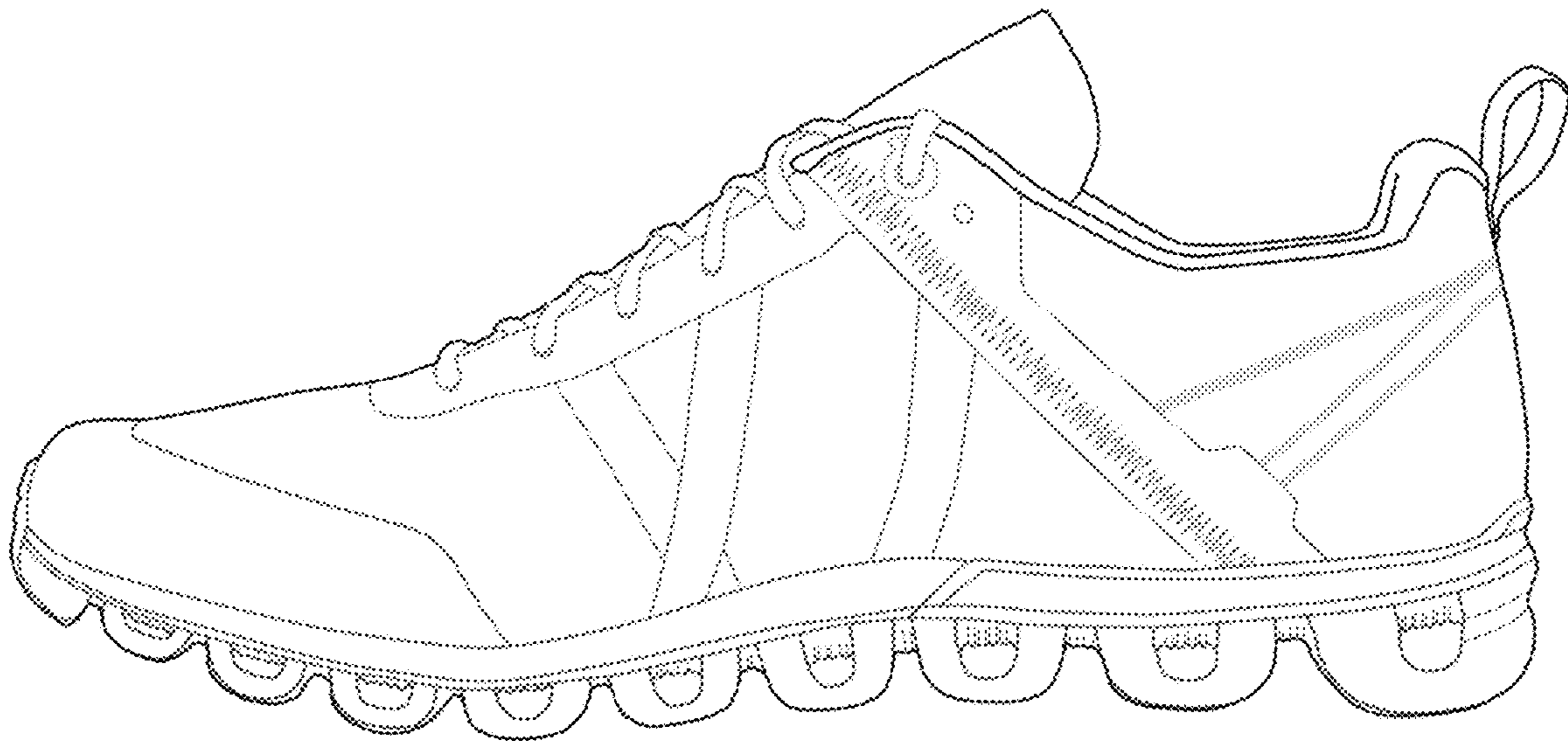

1.6

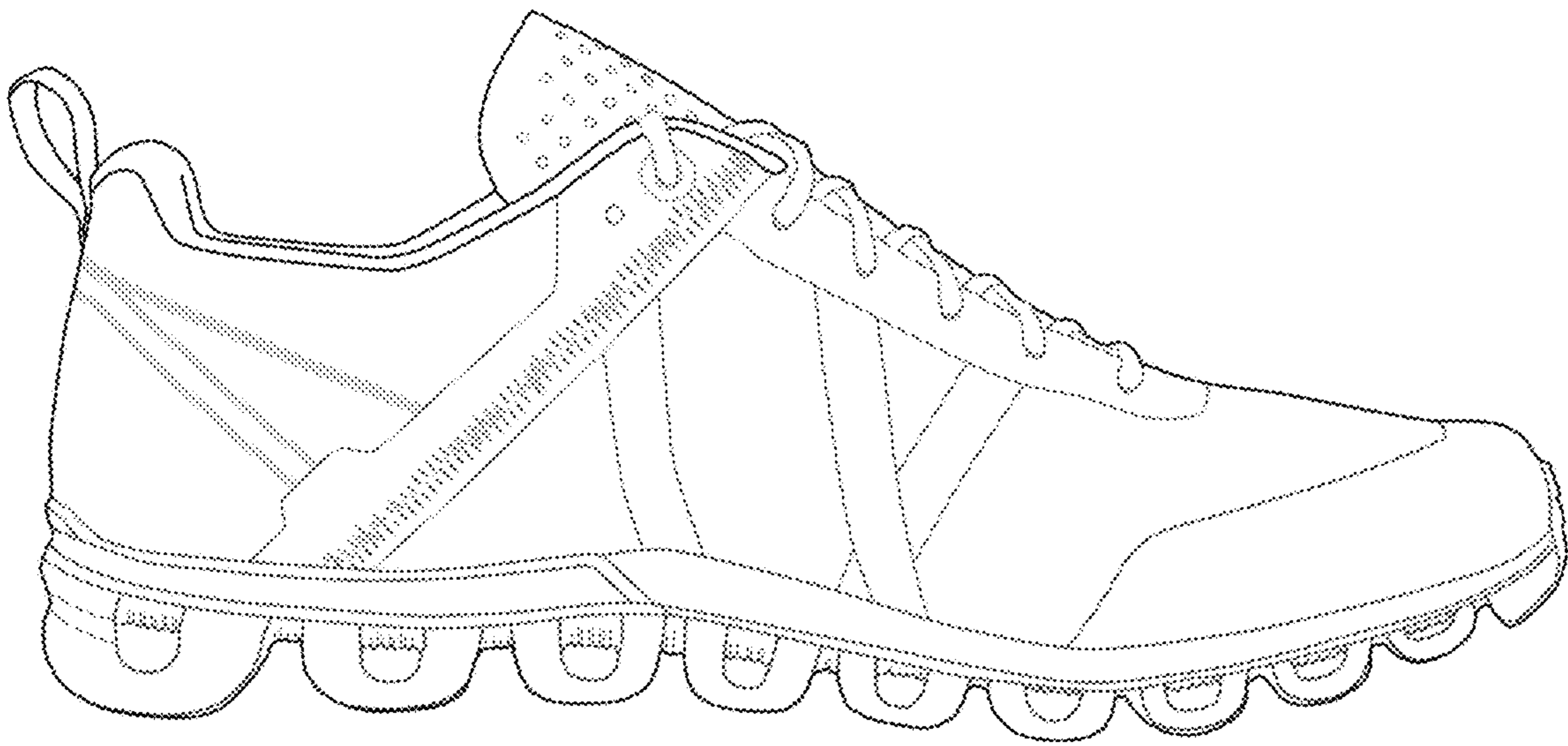

1.7

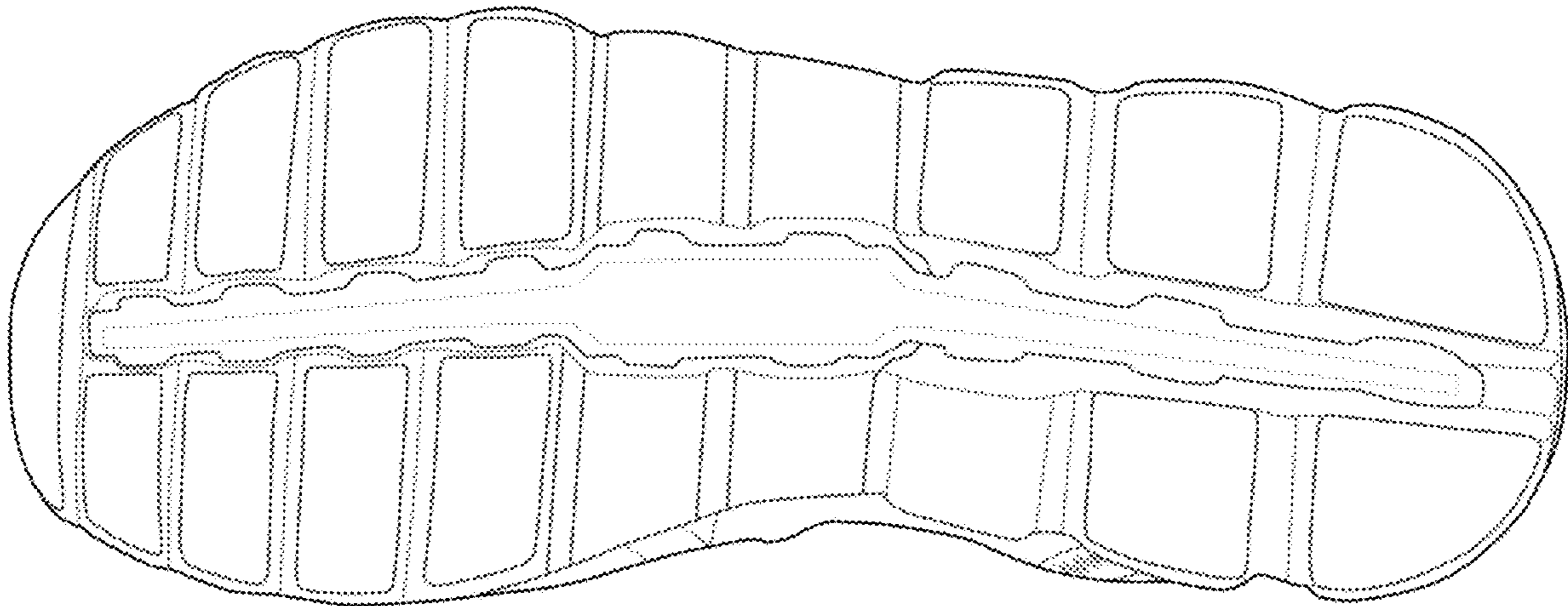

1.8

