



US00D813438S

(12) **United States Design Patent** (10) **Patent No.:** **US D813,438 S**
Vyvey (45) **Date of Patent:** **** Mar. 20, 2018**

(54) **LAMP**

(71) Applicant: **PHILIPS LIGHTING HOLDING B.V.**, Eindhoven (NL)

(72) Inventor: **Christophe Vyvey**, Beerse (BE)

(73) Assignee: **PHILIPS LIGHTING HOLDING B.V.**, Eindhoven (NL)

(**) Term: **15 Years**

(21) Appl. No.: **35/501,959**

(22) Filed: **Nov. 3, 2016**

(80) **Hague Agreement Data**

Int. Filing Date: **Nov. 3, 2016**

Int. Reg. No.: **DM/093409**

Int. Reg. Date: **Nov. 3, 2016**

Int. Reg. Pub. Date: **Nov. 25, 2016**

(51) **LOC (11) Cl.** **26-03**

(52) **U.S. Cl.**
USPC **D26/72**

(58) **Field of Classification Search**
USPC D26/72, 80-84, 88-91, 118, 143, 144
CPC F21S 8/028; F21S 8/036; F21S 8/04; F21S 8/043; F21S 8/046; F21S 8/06; F21S 8/061; F21S 8/063; F21S 8/065; F21S 8/068; F21V 21/03

See application file for complete search history.

(56) **References Cited**

U.S. PATENT DOCUMENTS

D434,518 S *	11/2000	Rivers	D26/110
D480,828 S *	10/2003	Block	D26/110
D485,003 S *	1/2004	Olson	D26/104
D589,203 S *	3/2009	Sabernig	D26/104
D640,821 S *	6/2011	Kocks	D26/89
D655,853 S *	3/2012	Kim	D26/89
D676,996 S *	2/2013	Gismondi	D26/104
D738,559 S *	9/2015	Epstein	D26/106

* cited by examiner

Primary Examiner — Zenia Bennett

(57) **CLAIM**

The ornamental design for a lamp, as shown and described.

DESCRIPTION

- 1. Lamp
- 1.1 : Perspective
- 1.2 : Left
- 1.3 : Right
- 1.4 : Front
- 1.5 : Back
- 1.6 : Top
- 1.7 : Bottom

1 Claim, 7 Drawing Sheets

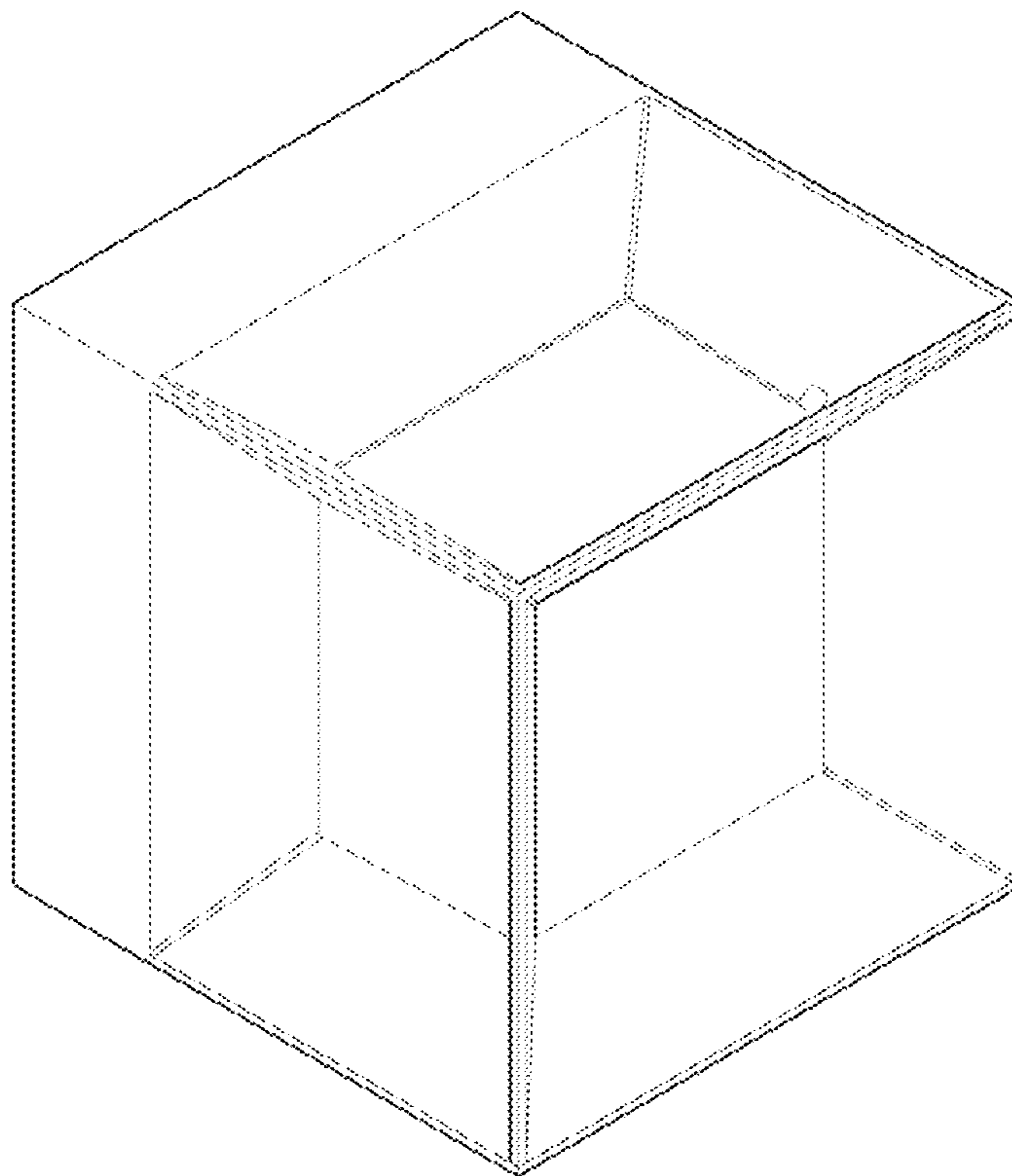

1.1

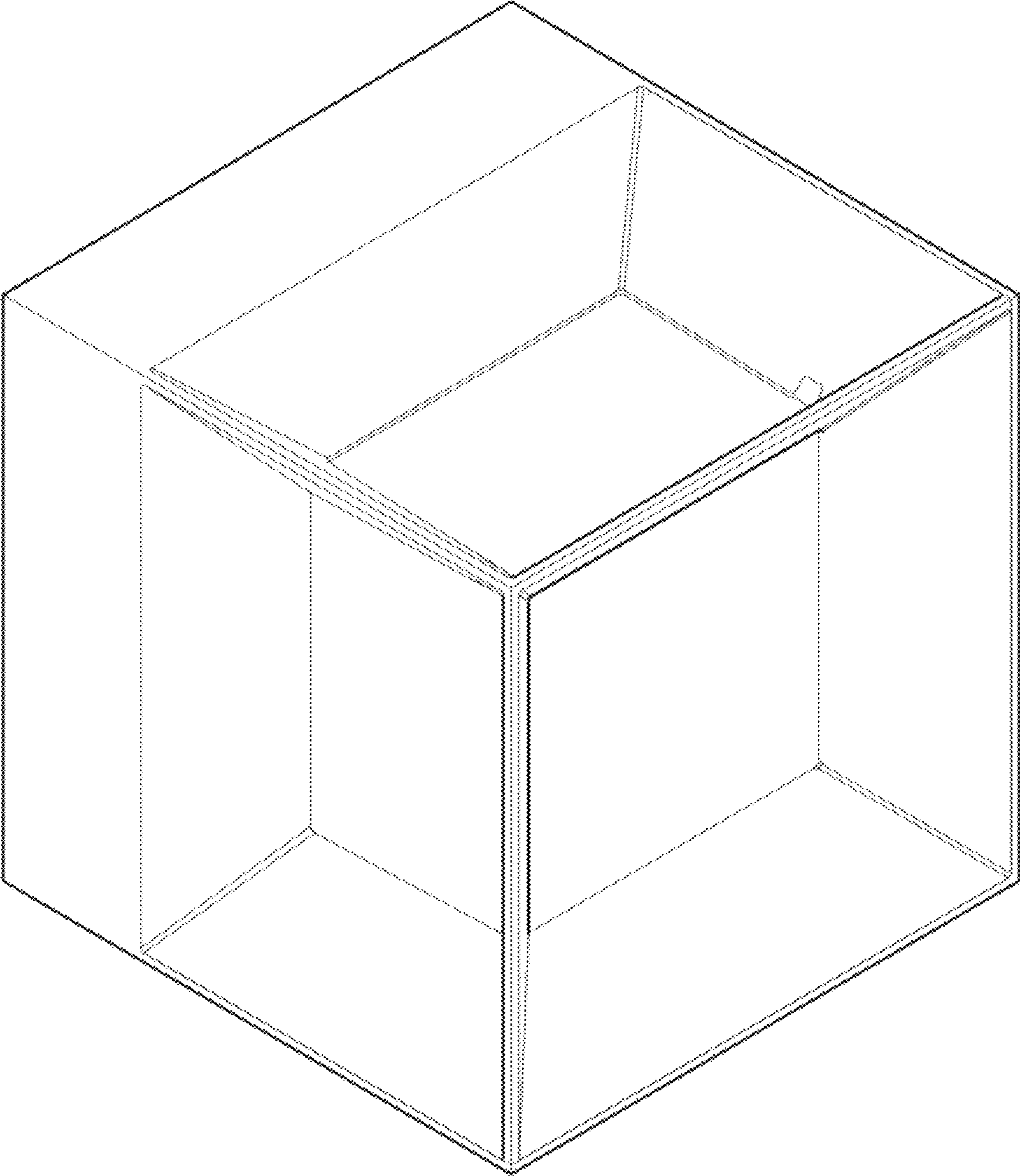

1.2

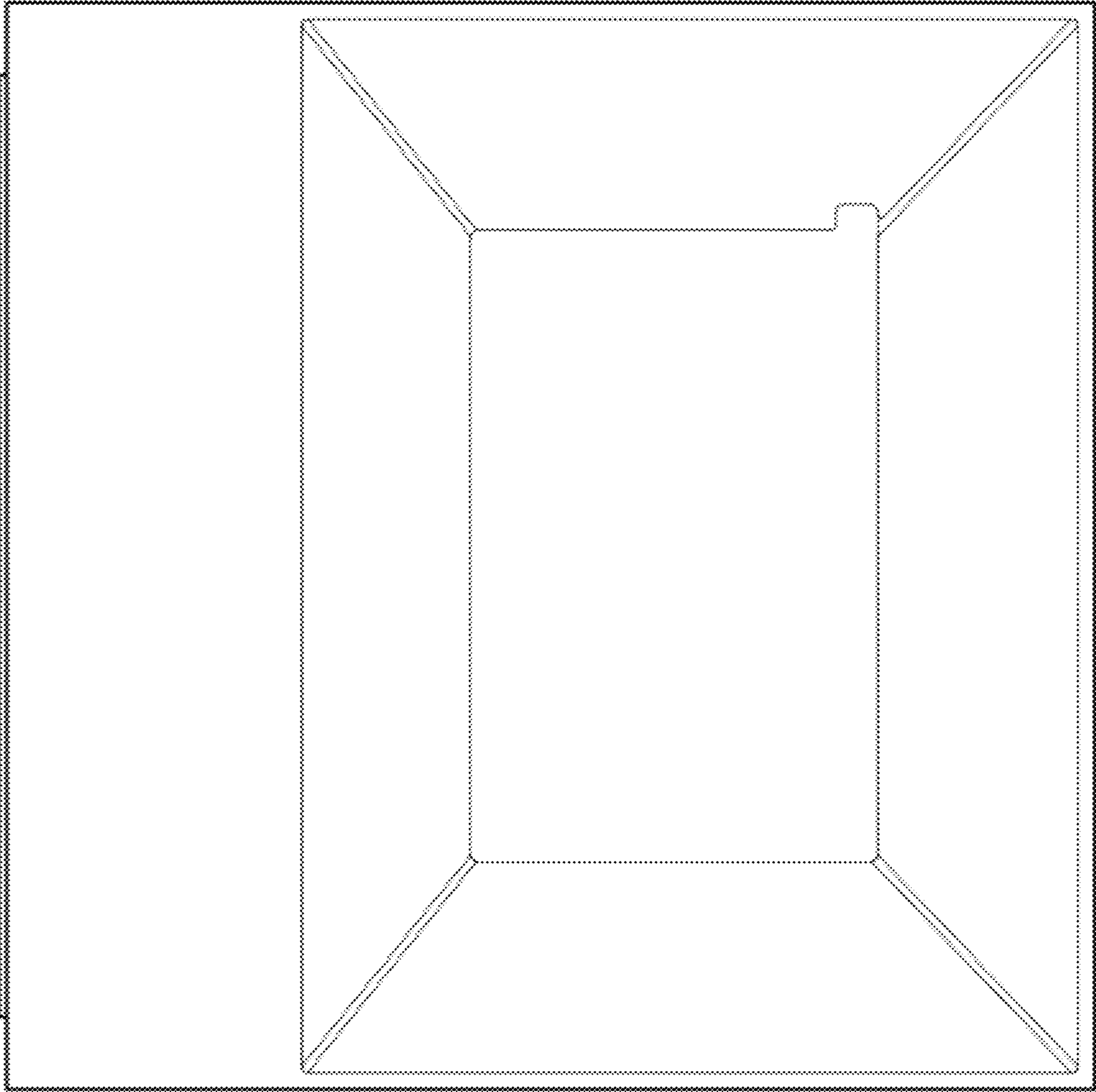

1.3

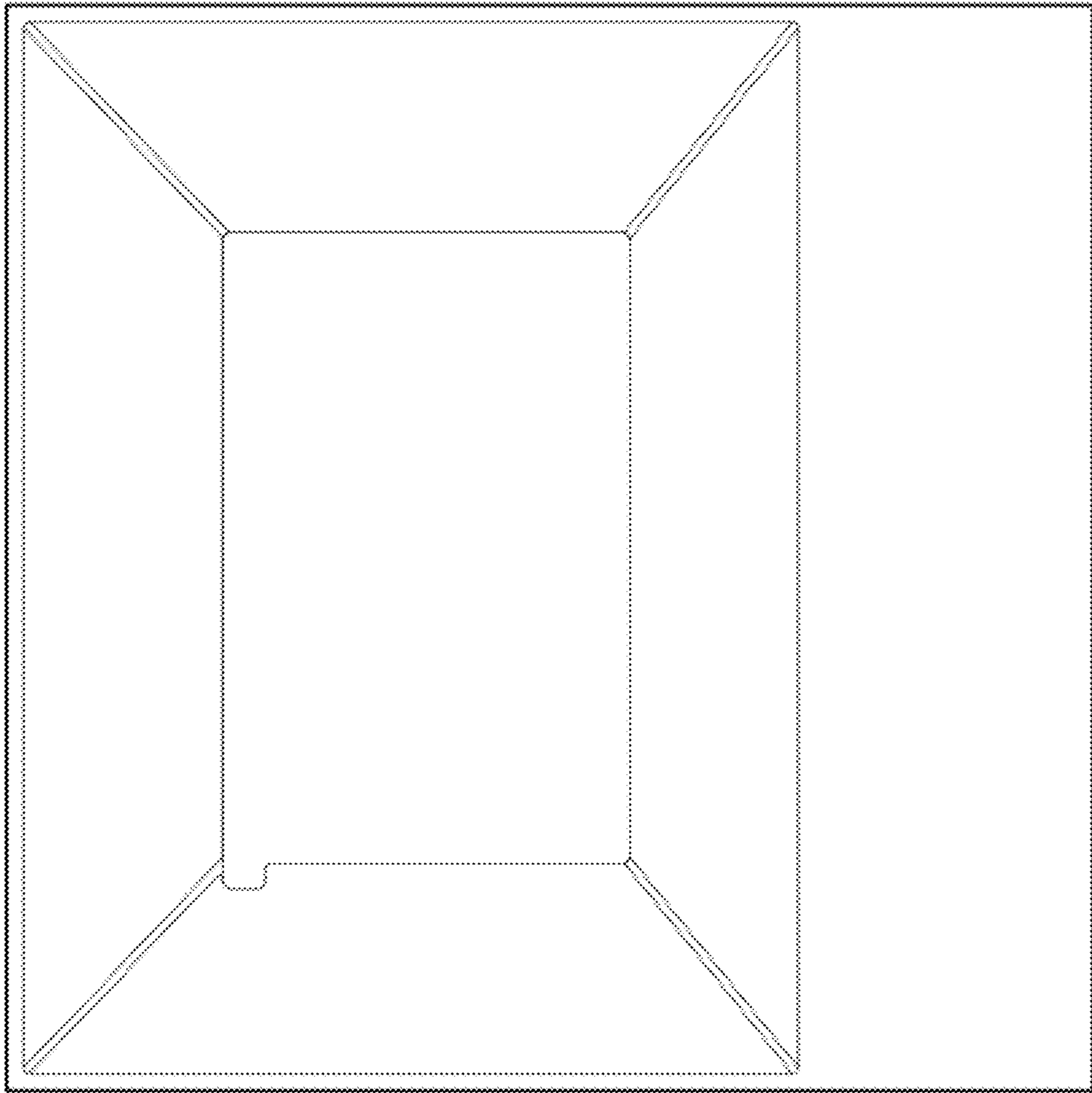

1.4

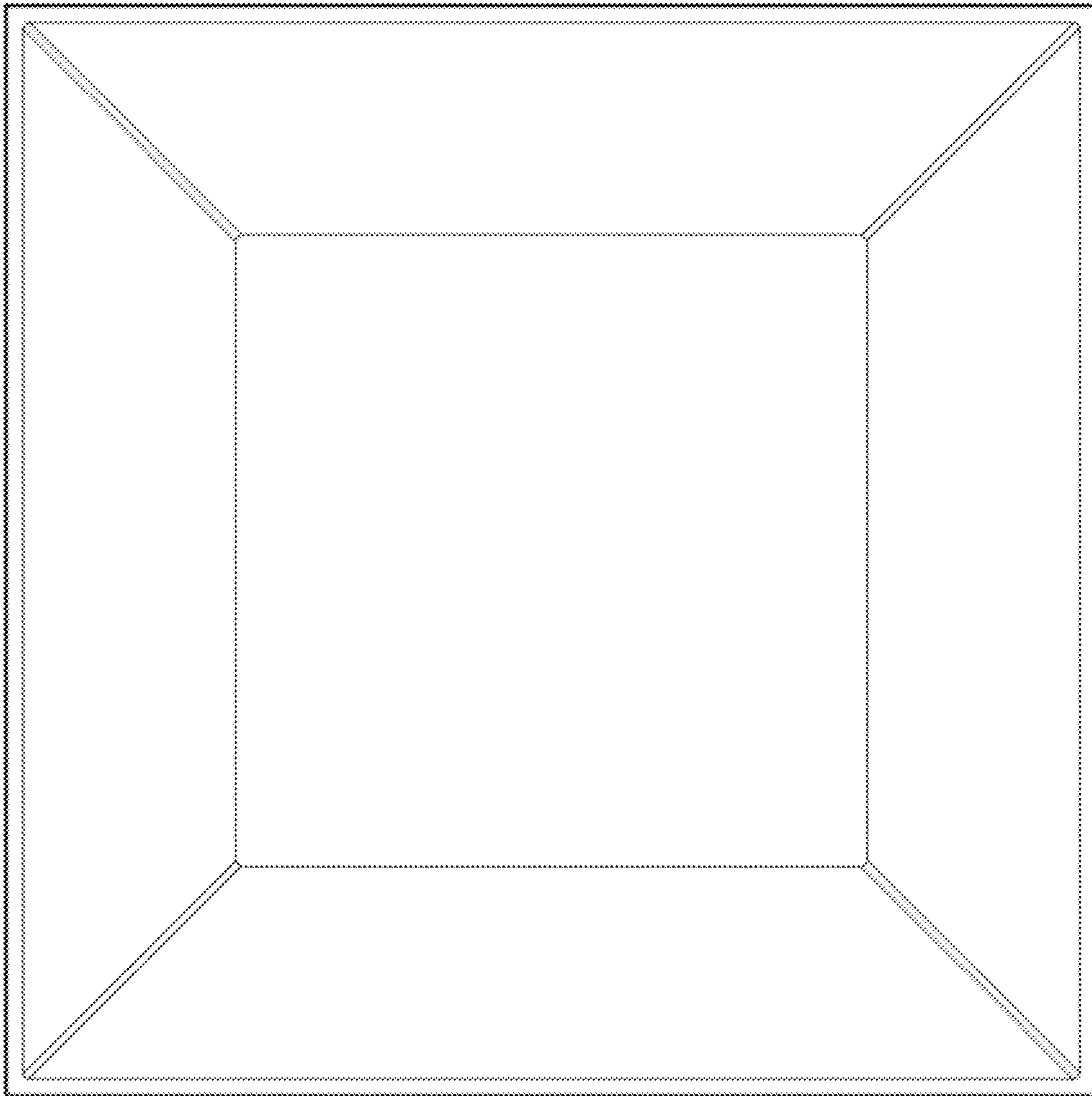

1.5

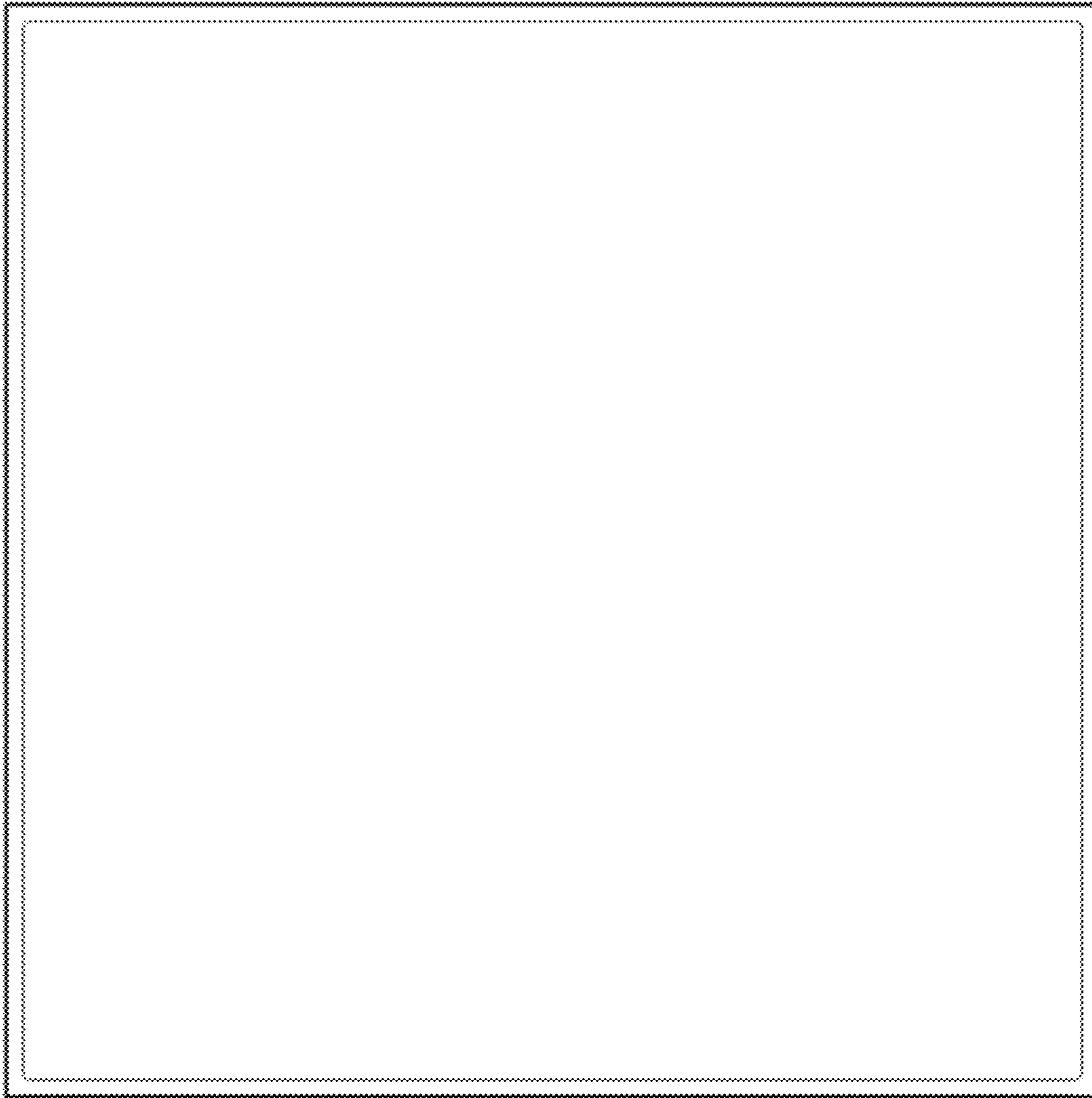

1.6

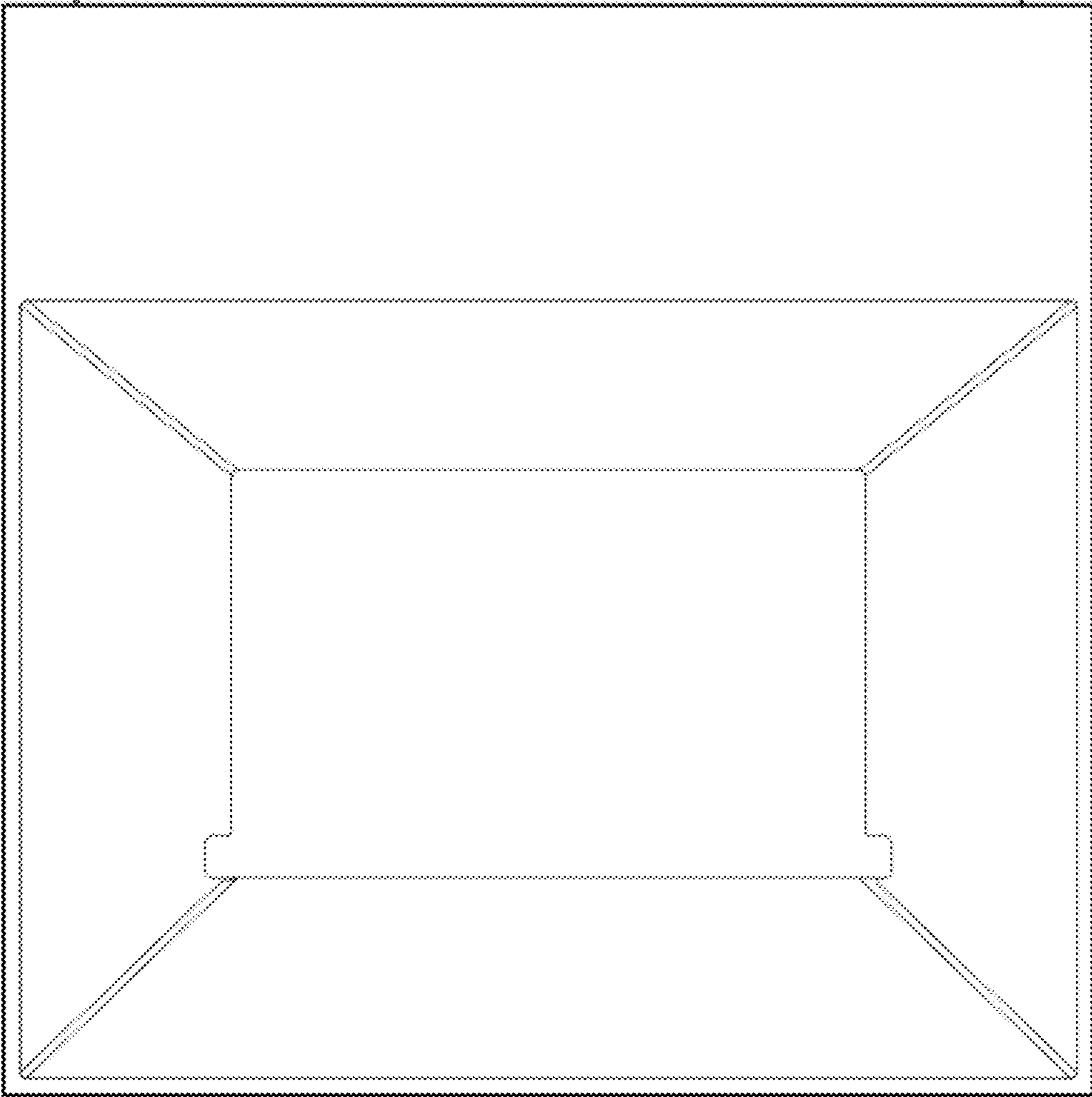

1.7

