



US00D813435S

(12) **United States Design Patent**
Verelst

(10) **Patent No.:** **US D813,435 S**
(45) **Date of Patent:** **** Mar. 20, 2018**

(54) **LAMP**

CPC . F21S 8/033; F21S 8/085; F21S 8/086; F21V
21/30; F21W 2111/02

(71) Applicant: **PHILIPS LIGHTING HOLDING
B.V., Eindhoven (NL)**

See application file for complete search history.

(72) Inventor: **Dirk Maria Karel Rosalia Verelst,
Boechout (NL)**

(56) **References Cited**

(73) Assignee: **PHILIPS LIGHTING HOLDING
B.V., Eindhoven (NL)**

U.S. PATENT DOCUMENTS

(**) Term: **15 Years**

D236,909 S *	9/1975	Richilano	D26/68
D294,066 S *	2/1988	Ewing	D26/71
D383,866 S *	9/1997	Brohard	D26/67
D678,580 S *	3/2013	Rizzi	D26/71
D694,454 S *	11/2013	Fang	D26/71
D783,882 S *	4/2017	Dolan	D26/87
D795,483 S *	8/2017	Sonneman	D26/71
D802,814 S *	11/2017	Sonneman	D26/71

(21) Appl. No.: **35/501,956**

* cited by examiner

(22) Filed: **Nov. 2, 2016**

Primary Examiner — Zenia Bennett

(80) **Hague Agreement Data**

Int. Filing Date: **Nov. 2, 2016**

Int. Reg. No.: **DM/093398**

Int. Reg. Date: **Nov. 2, 2016**

Int. Reg. Pub. Date: **Nov. 25, 2016**

(57) **CLAIM**

The ornamental design for a lamp, as shown and described.

(30) **Foreign Application Priority Data**

May 4, 2016 (EM) 003110006-0005

(51) **LOC (11) Cl.** **26-05**

(52) **U.S. Cl.**
USPC **D26/71**

(58) **Field of Classification Search**
USPC D26/63, 71, 92

DESCRIPTION

- 1. Lamp
- 1.1 : Perspective
- 1.2 : Front
- 1.3 : Back
- 1.4 : Right
- 1.5 : Left
- 1.6 : Top
- 1.7 : Bottom

1 Claim, 7 Drawing Sheets

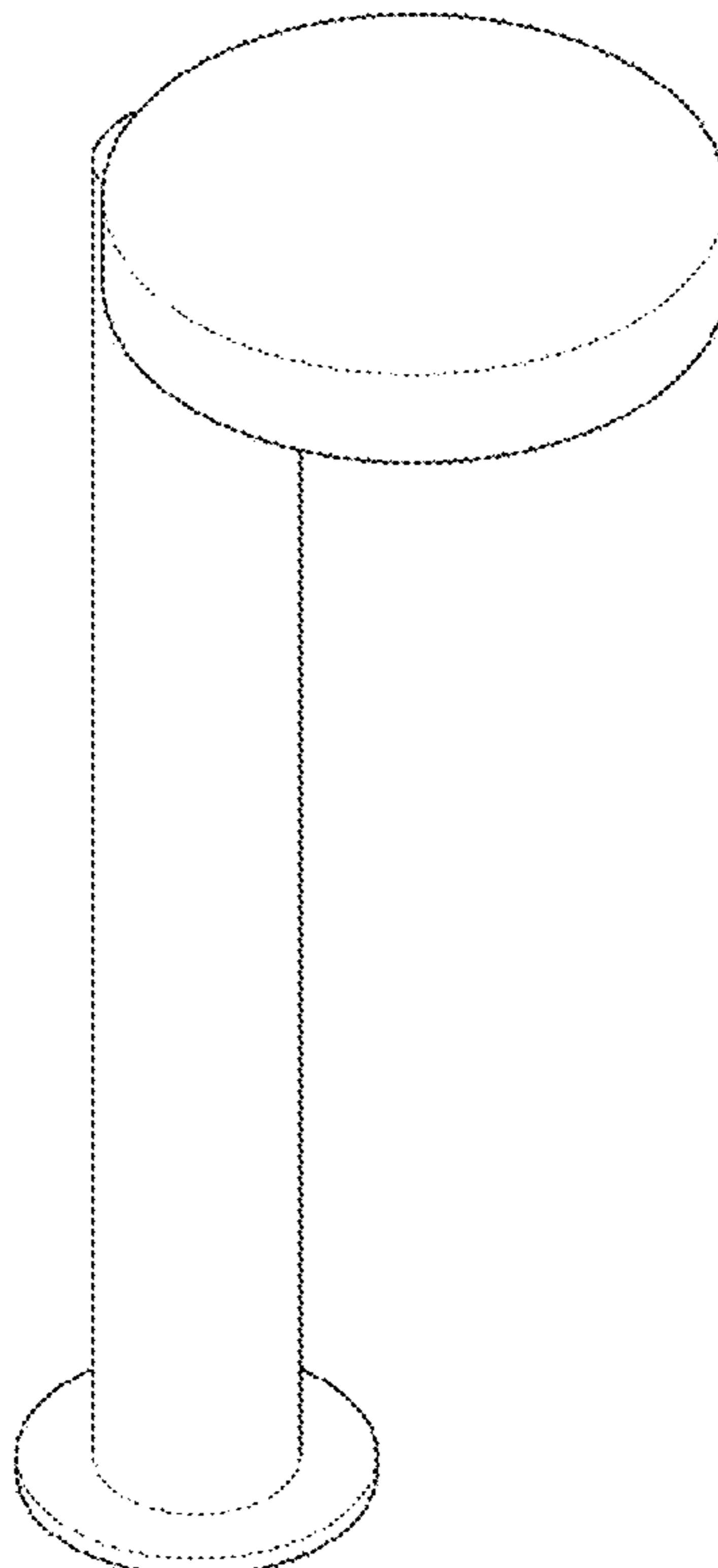

1.1

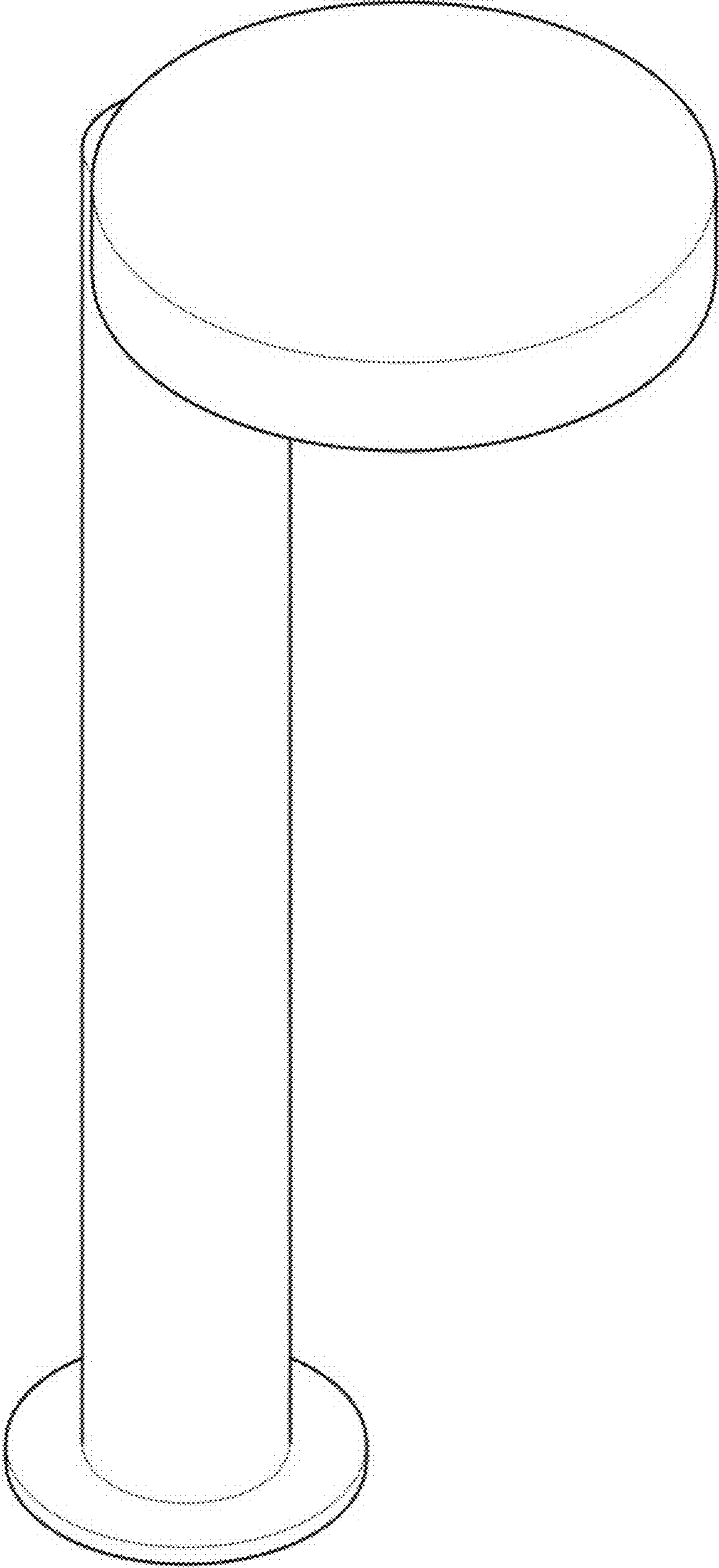

1.2

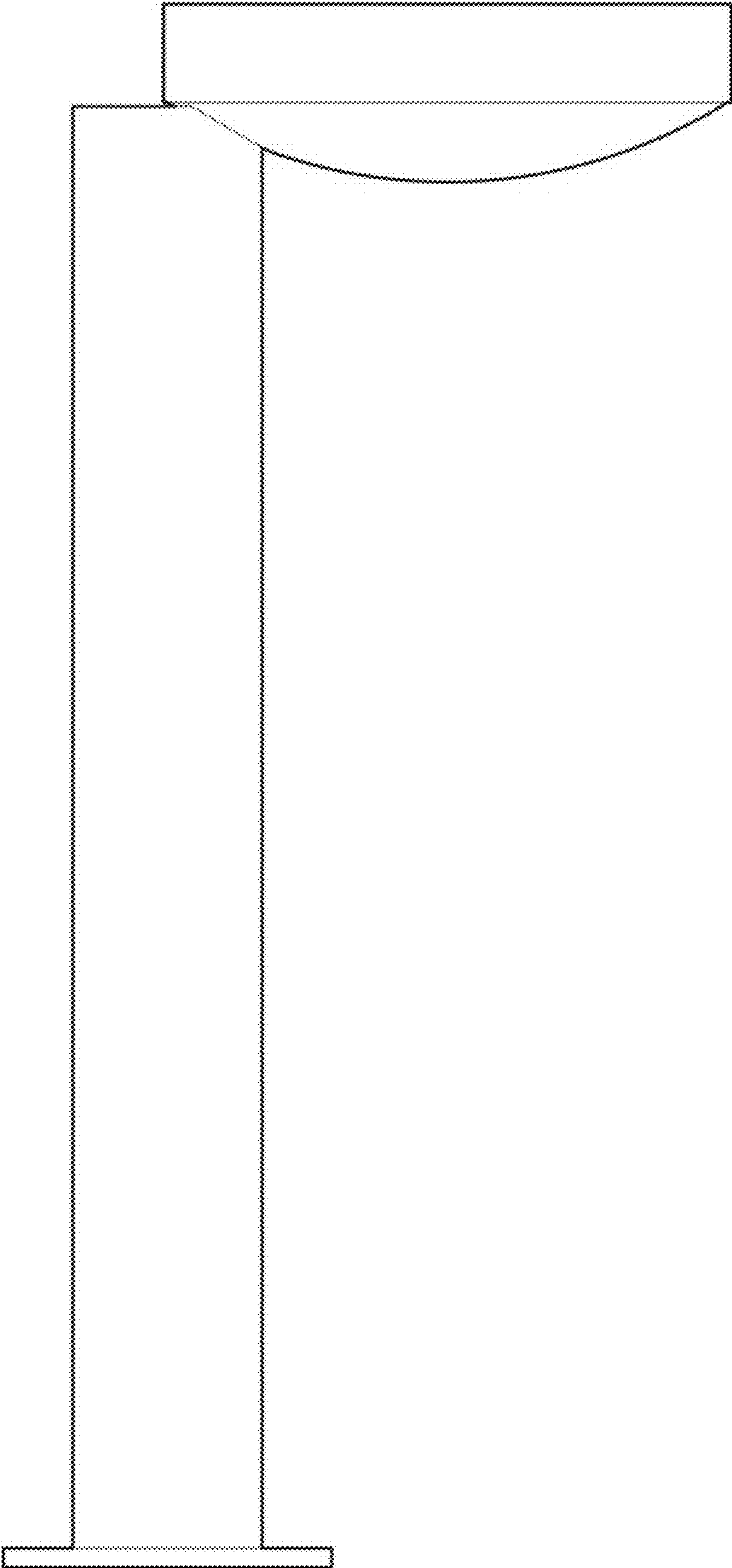

1.3

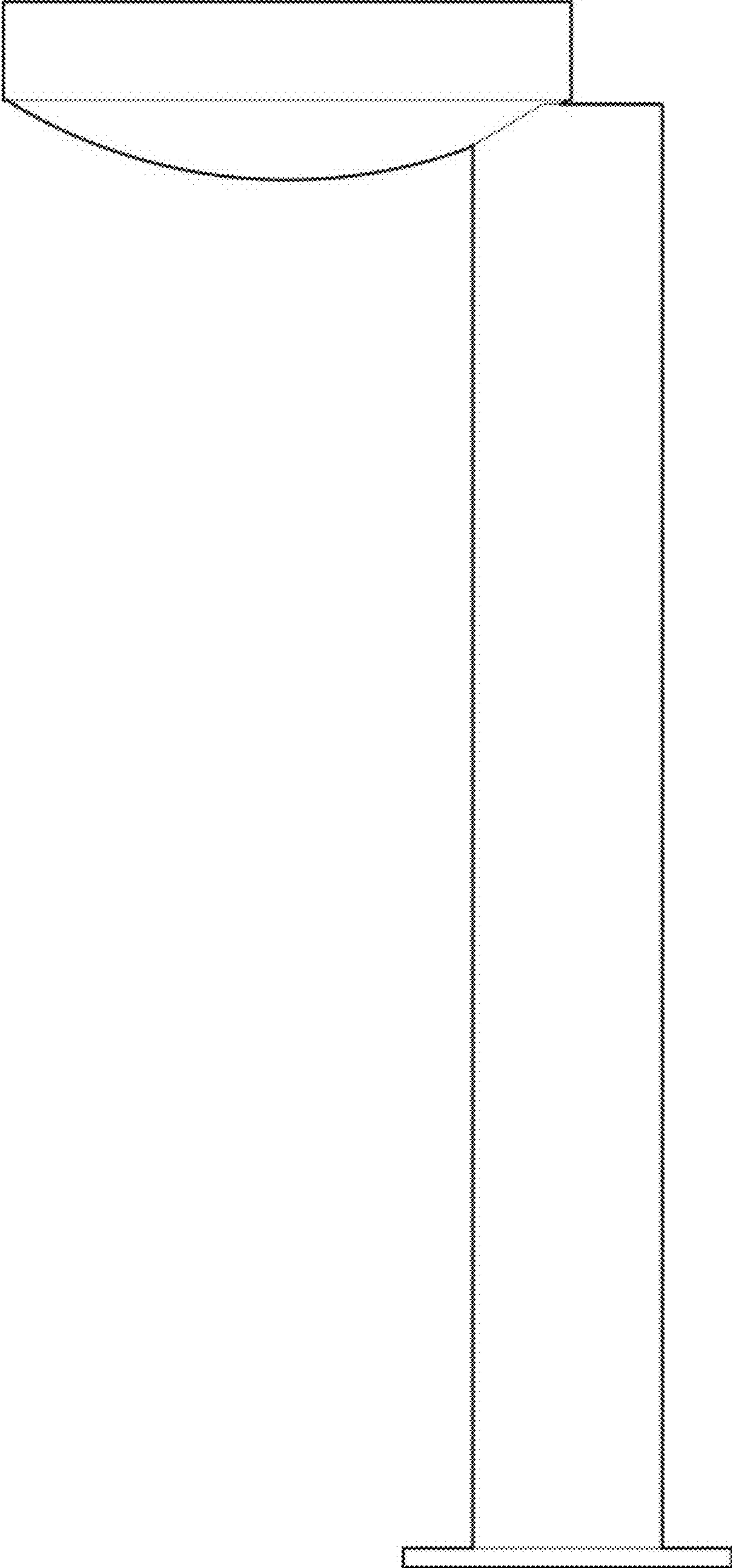

1.4

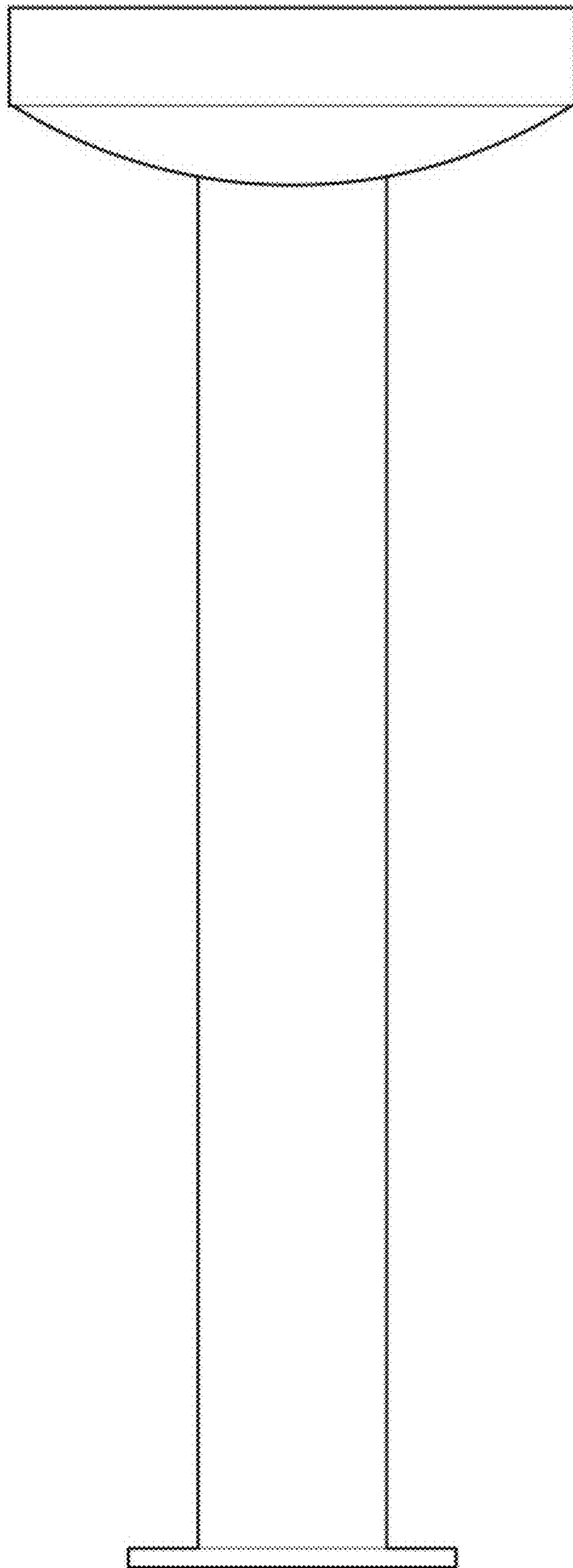

1.5

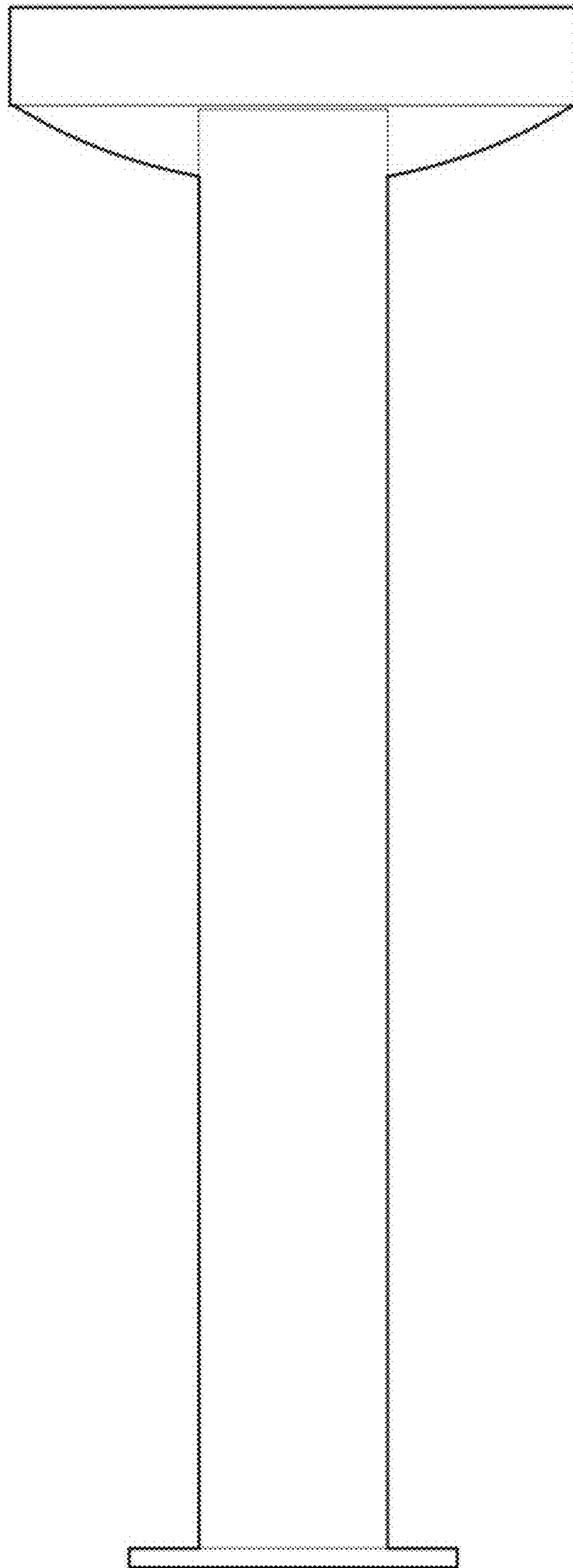

1.6

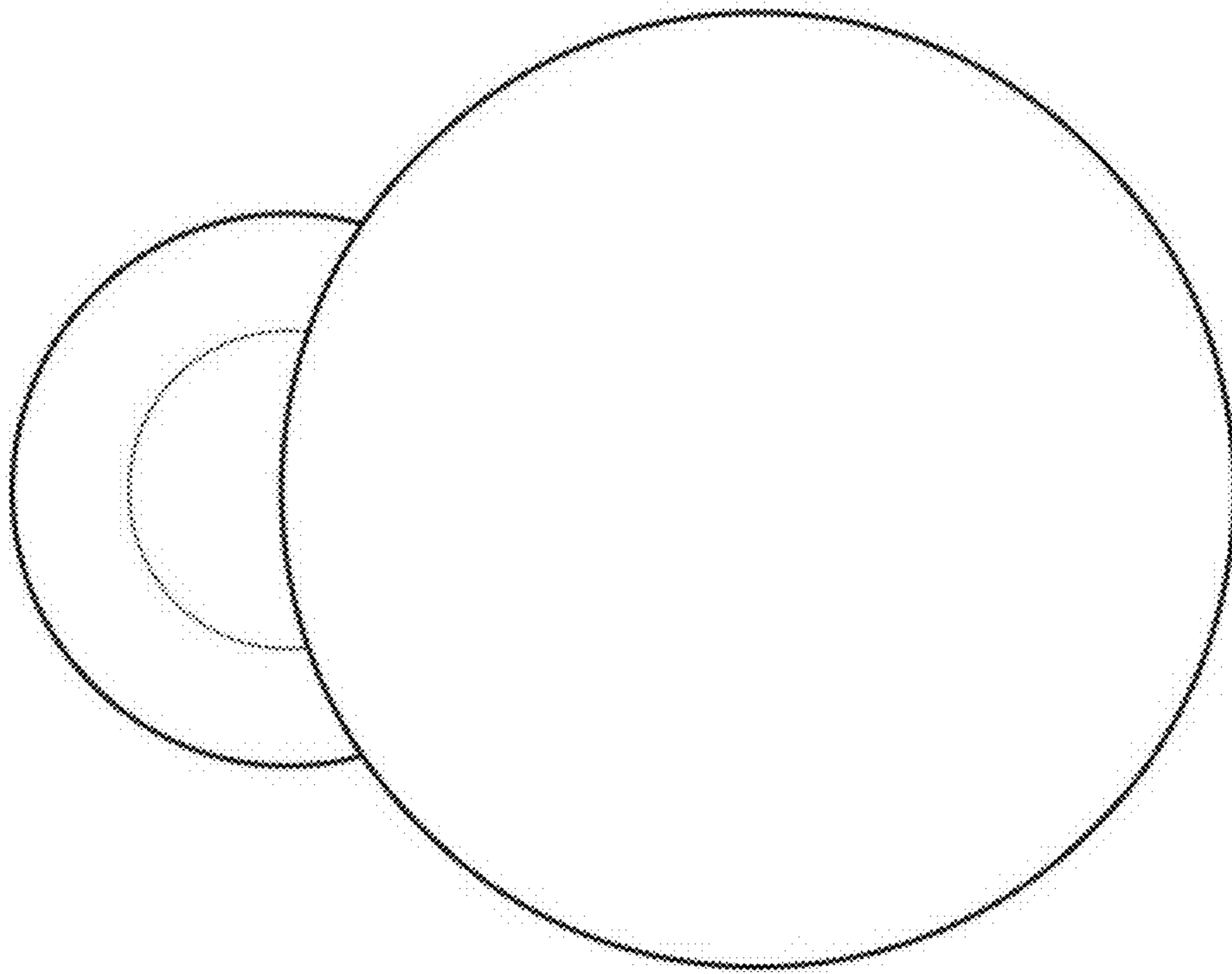

1.7

