



US00D813339S

(12) **United States Design Patent**
Maroney

(10) **Patent No.:** **US D813,339 S**
(45) **Date of Patent:** **** Mar. 20, 2018**

(54) **FIREARM GRIP SLEEVE**

(71) Applicant: **Samuel P. Maroney**, Springfield, VA
(US)

(72) Inventor: **Samuel P. Maroney**, Springfield, VA
(US)

(**) Term: **15 Years**

(21) Appl. No.: **29/562,353**

(22) Filed: **Apr. 25, 2016**

(51) **LOC (11) Cl.** **22-01**

(52) **U.S. Cl.**
USPC **D22/108**

(58) **Field of Classification Search**
USPC D22/108; D8/68

(Continued)

(56) **References Cited**

U.S. PATENT DOCUMENTS

1,751,780 A * 3/1930 Weiger B60L 5/06
148/407

2,437,404 A 3/1948 Robinson
(Continued)

OTHER PUBLICATIONS

Botach, "FAB Defense FN FAL Ergonomic Pistol Grip," printed
Apr. 25, 2016, 6 pages, <https://www.botach.com/fab-defense-fn-fal-ergonomic-pistol-grip/>.

(Continued)

Primary Examiner — Michael A Pratt

(74) *Attorney, Agent, or Firm* — LaBatt, LLC

(57) **CLAIM**

The ornamental design for a firearm grip sleeve, as shown
and described.

DESCRIPTION

FIG. 1 is a perspective view of a firearm grip sleeve in a
position of use on a firearm according to the present design.

FIG. 2 is a right elevation view of the firearm grip sleeve
shown in FIG. 1.

FIG. 3 is a left elevation view of the firearm grip sleeve
shown in FIG. 1.

FIG. 4 is a rear elevation view of the firearm grip sleeve
shown in FIG. 1.

FIG. 5 is a front elevation view of the firearm grip sleeve
shown in FIG. 1.

FIG. 6 is a top elevation view of the firearm grip sleeve
shown in FIG. 1.

FIG. 7 is a bottom elevation view of the firearm grip sleeve
shown in FIG. 1.

FIG. 8 is a perspective view of a firearm grip sleeve in a
position of rest according to a first embodiment of the
present design.

FIG. 9 is a top elevation view of the firearm grip sleeve
shown in FIG. 8.

FIG. 10 is a bottom elevation view of the firearm grip sleeve
shown in FIG. 8.

FIG. 11 is a right elevation view of the firearm grip sleeve
shown in FIG. 8.

FIG. 12 is a left elevation view of the firearm grip sleeve
shown in FIG. 8.

FIG. 13 is a front elevation view of the firearm grip sleeve
shown in FIG. 8.

FIG. 14 is a rear elevation view of the firearm grip sleeve
shown in FIG. 8.

FIG. 15 is a perspective view of a firearm grip sleeve in a
position of rest according to a second embodiment of the
present design.

FIG. 16 is a top elevation view of the firearm grip sleeve
shown in FIG. 15.

FIG. 17 is a bottom elevation view of the firearm grip sleeve
shown in FIG. 15.

FIG. 18 is a right elevation view of the firearm grip sleeve
shown in FIG. 15.

FIG. 19 is a left elevation view of the firearm grip sleeve
shown in FIG. 15.

FIG. 20 is a front elevation view of the firearm grip sleeve
shown in FIG. 15; and,

FIG. 21 is a rear elevation view of the firearm grip sleeve
shown in FIG. 15.

(Continued)

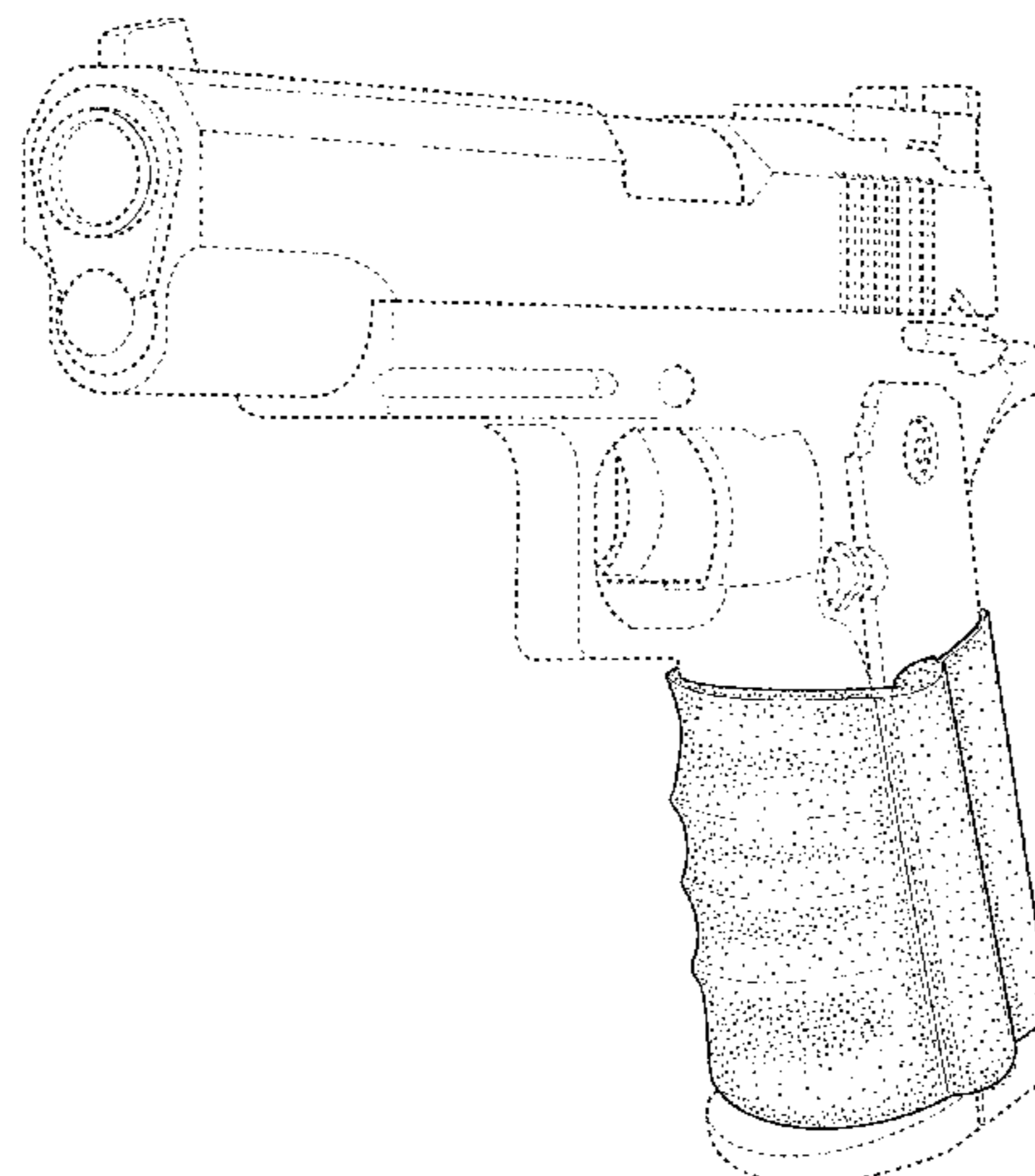

The broken line showing of a firearm in FIG. 1 is for the purpose of illustrating environment and forms no part of the claimed design.

1 Claim, 12 Drawing Sheets

(58) Field of Classification Search

CPC F41C 23/10; F41C 23/14; F41C 23/16;
F41C 23/18

See application file for complete search history.

(56) References Cited

U.S. PATENT DOCUMENTS

2,831,948 A * 4/1958 Fraser H02B 1/048
174/110 R
3,189,069 A 6/1965 Stowell
3,410,017 A * 11/1968 Wilson A01K 87/08
43/22
3,614,100 A * 10/1971 Spitz A63B 49/08
473/298
3,815,270 A 6/1974 Pachmayr
4,098,506 A * 7/1978 Gaiser A63B 49/08
273/DIG. 8
4,440,835 A * 4/1984 Vignaud H01M 4/8626
429/522
4,660,311 A 4/1987 Breitfeld et al.
4,691,986 A * 9/1987 Aberson, Jr. G02B 6/382
385/64
5,125,286 A * 6/1992 Wilson B62K 21/26
473/298
D330,837 S * 11/1992 Harmon D8/80
5,199,706 A * 4/1993 Chen A63B 49/08
473/299
5,231,237 A 7/1993 Cupp
D349,938 S * 8/1994 Hogue D22/104
D351,448 S * 10/1994 Fisher 42/71.02
D351,638 S * 10/1994 Scott 42/71.02
5,406,731 A 4/1995 Stevens
5,469,601 A * 11/1995 Jackson A47J 45/10
16/421

D375,240 S * 11/1996 Campbell D8/80
5,621,834 A * 4/1997 Anderson G02B 6/3874
385/72
D393,194 S * 4/1998 Hogue D8/303
5,810,525 A * 9/1998 Ector, Sr. B25F 5/029
206/362
D424,775 S * 5/2000 Rabinowitz D34/27
6,112,446 A 9/2000 Forster et al.
6,802,148 B1 10/2004 Danas
7,332,238 B2 * 2/2008 Motupally F16K 15/147
429/407
7,435,186 B1 10/2008 Miller
7,467,489 B2 12/2008 Gussalli Beretta
8,857,093 B2 10/2014 Hogue
8,950,098 B2 2/2015 Sims et al.
D733,829 S 7/2015 Chvala
2004/0107621 A1 6/2004 Segalle
2005/0188587 A1 9/2005 Danas
2006/0068148 A1 3/2006 Ulrich
2006/0096147 A1 * 5/2006 Gussalli Beretta F41C 23/10
42/71.02
2006/0287124 A1 12/2006 Han et al.
2010/0011540 A1 * 1/2010 Chen B25G 1/102
16/430
2010/0298063 A1 11/2010 Gill et al.
2011/0167698 A1 7/2011 Hogue
2011/0258900 A1 * 10/2011 Sims F41C 23/08
42/71.02
2013/0047379 A1 2/2013 Zilke
2015/0082679 A1 3/2015 Michal et al.
2015/0300775 A1 10/2015 Combs

OTHER PUBLICATIONS

Klein, G., U.S. Appl. No. 15/137,822, Office Action, dated Dec. 12, 2016, 18 pages.
TUFF1 Gun Grip Covers, <https://web.archive.org/web/20130607044526/http://www.tuff1.com/gun-grips-tuff1-deathgrip-the-worlds-best-universal-gun-grip/>. Jun. 7, 2013.
Klein, G., U.S. Appl. No. 15/137,822, Final Rejection1, dated Oct. 23, 2017, 18 pages.

* cited by examiner

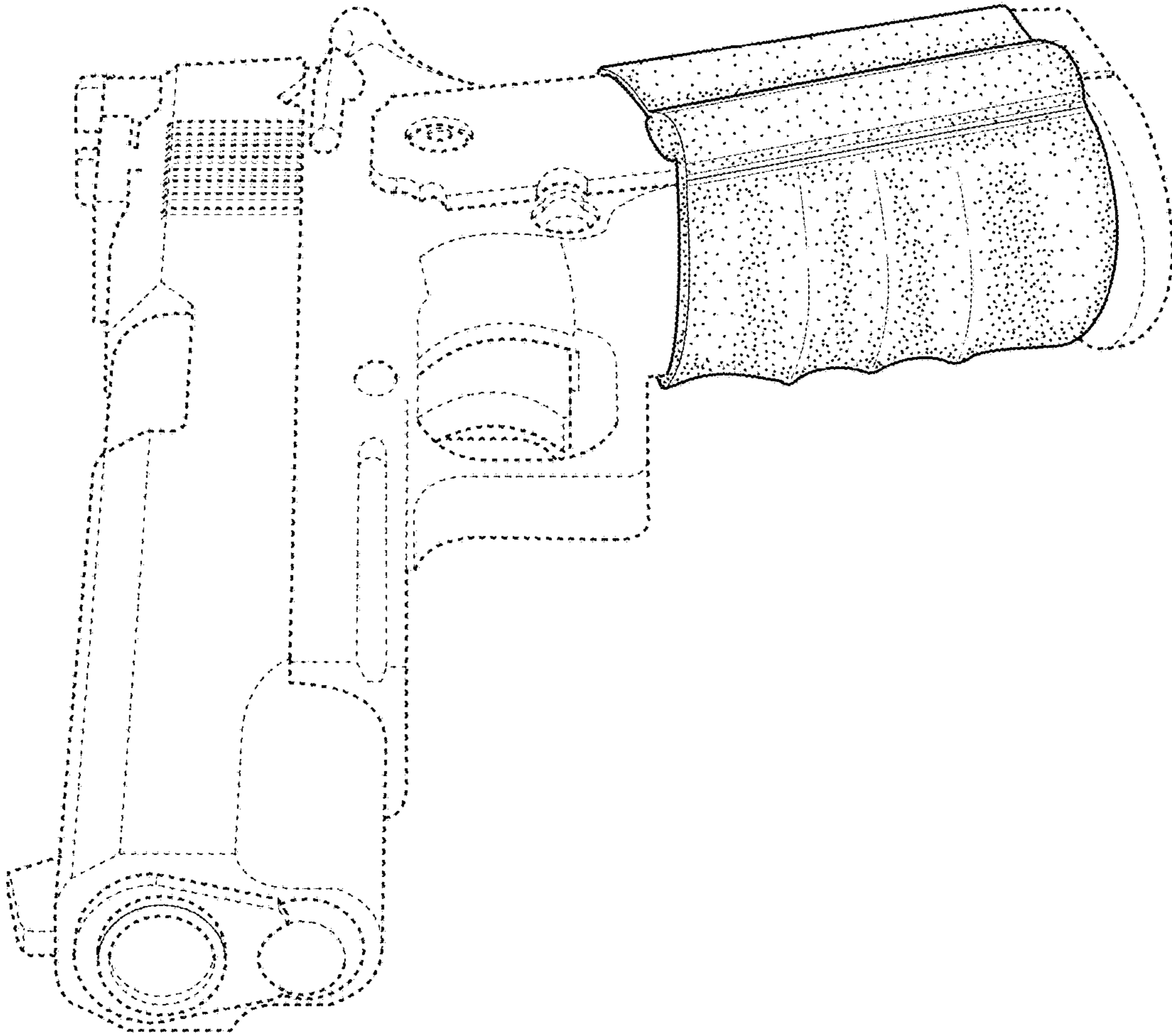

FIG. 1

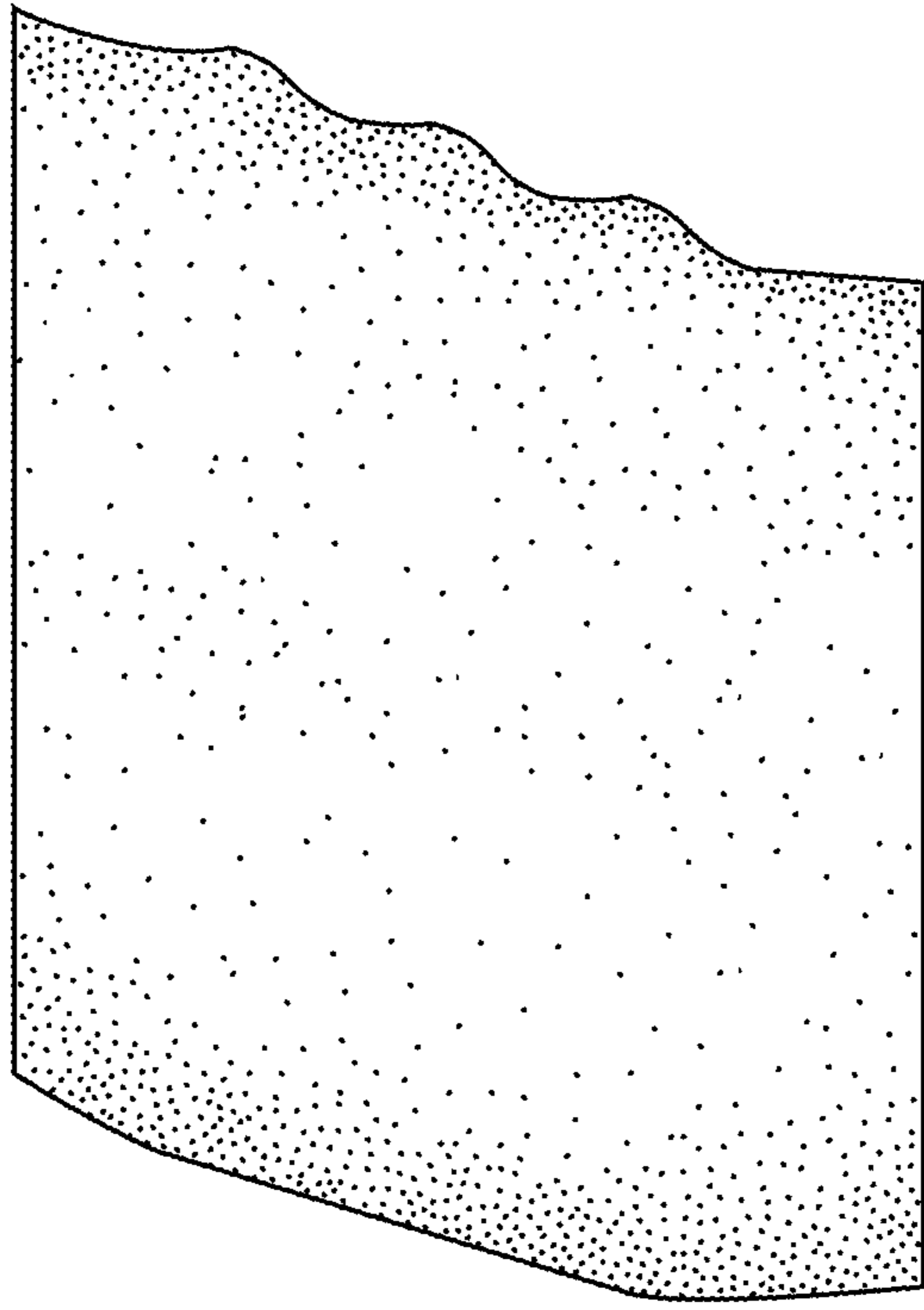

FIG. 3

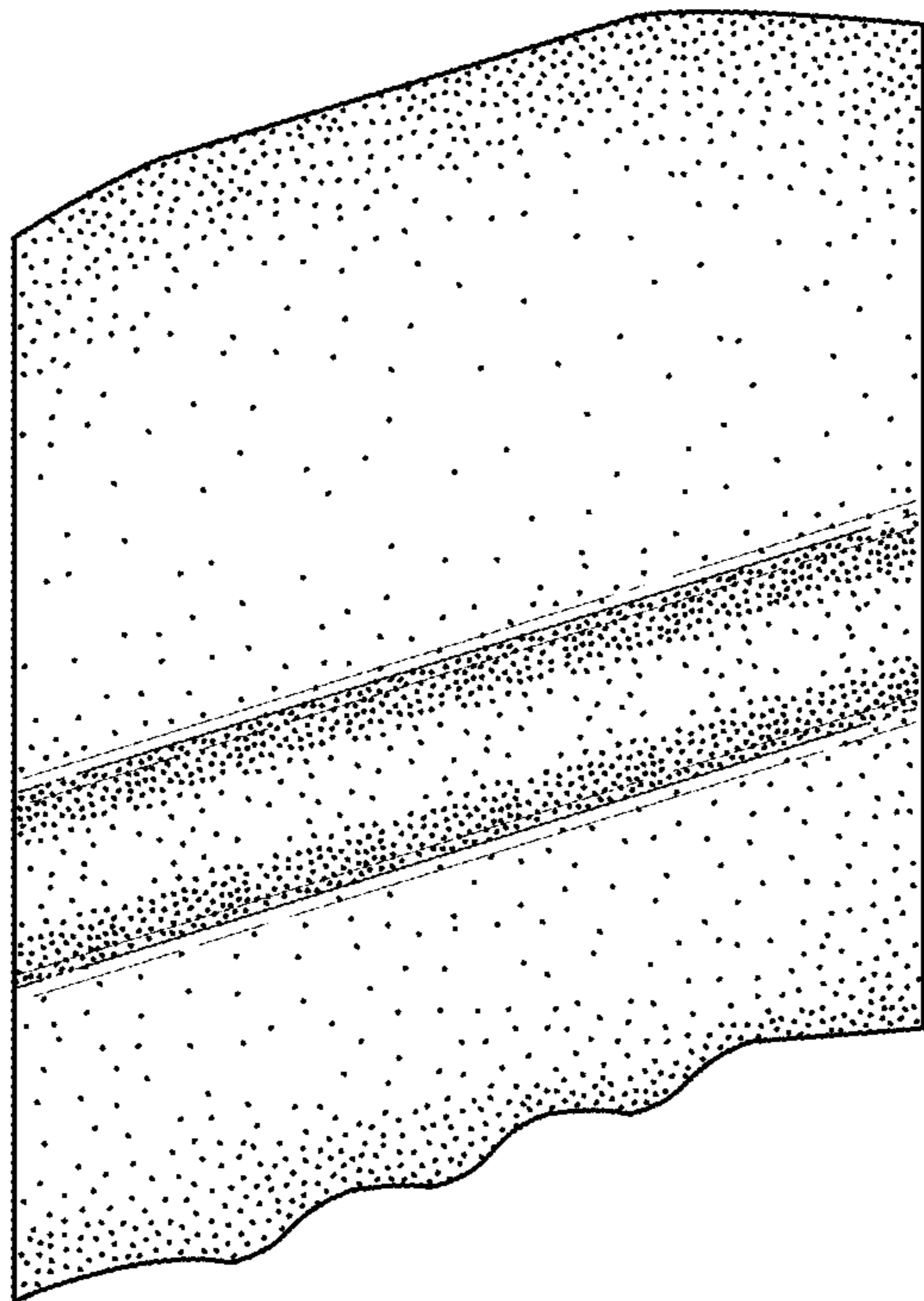

FIG. 2

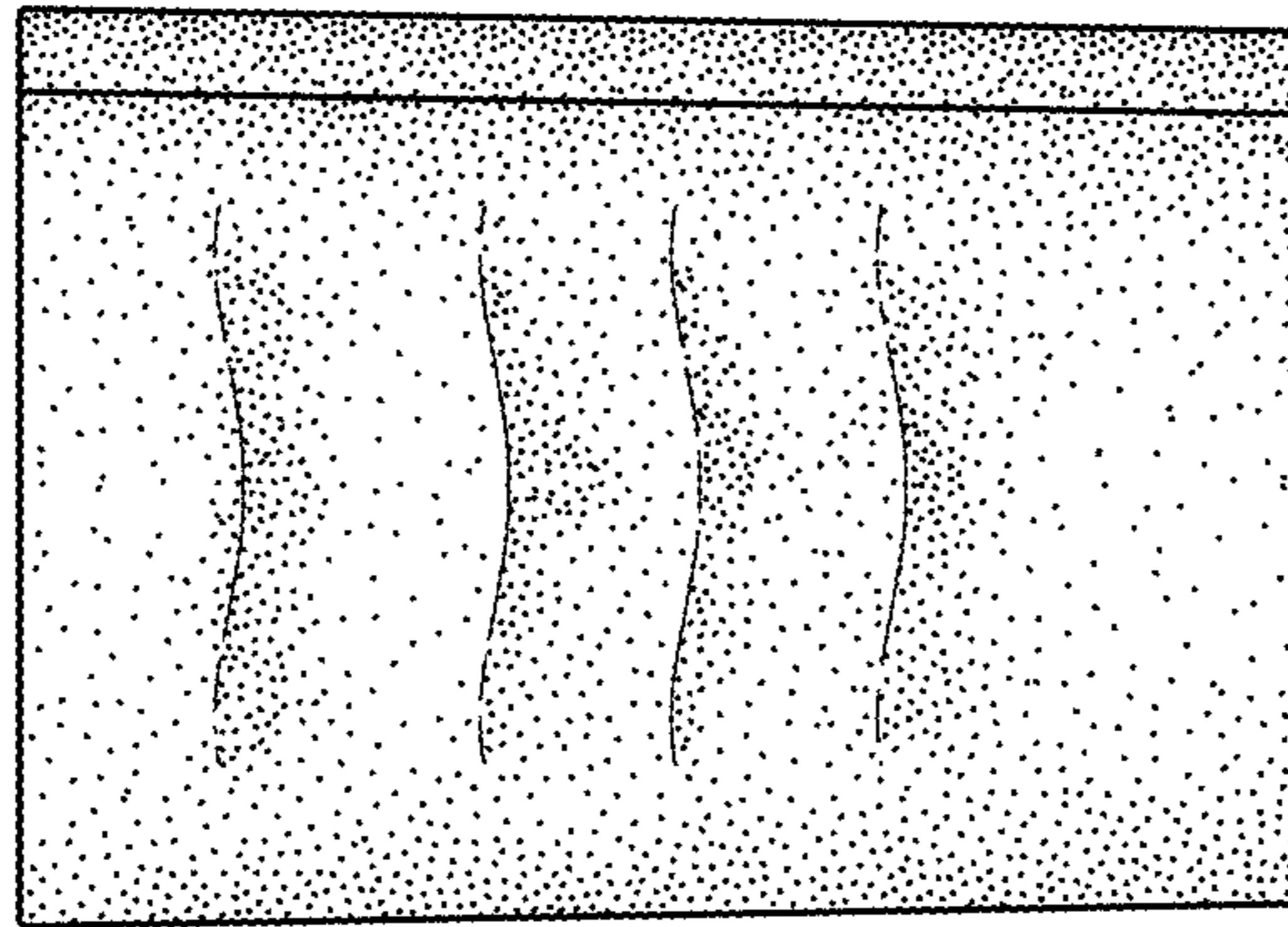

FIG. 5

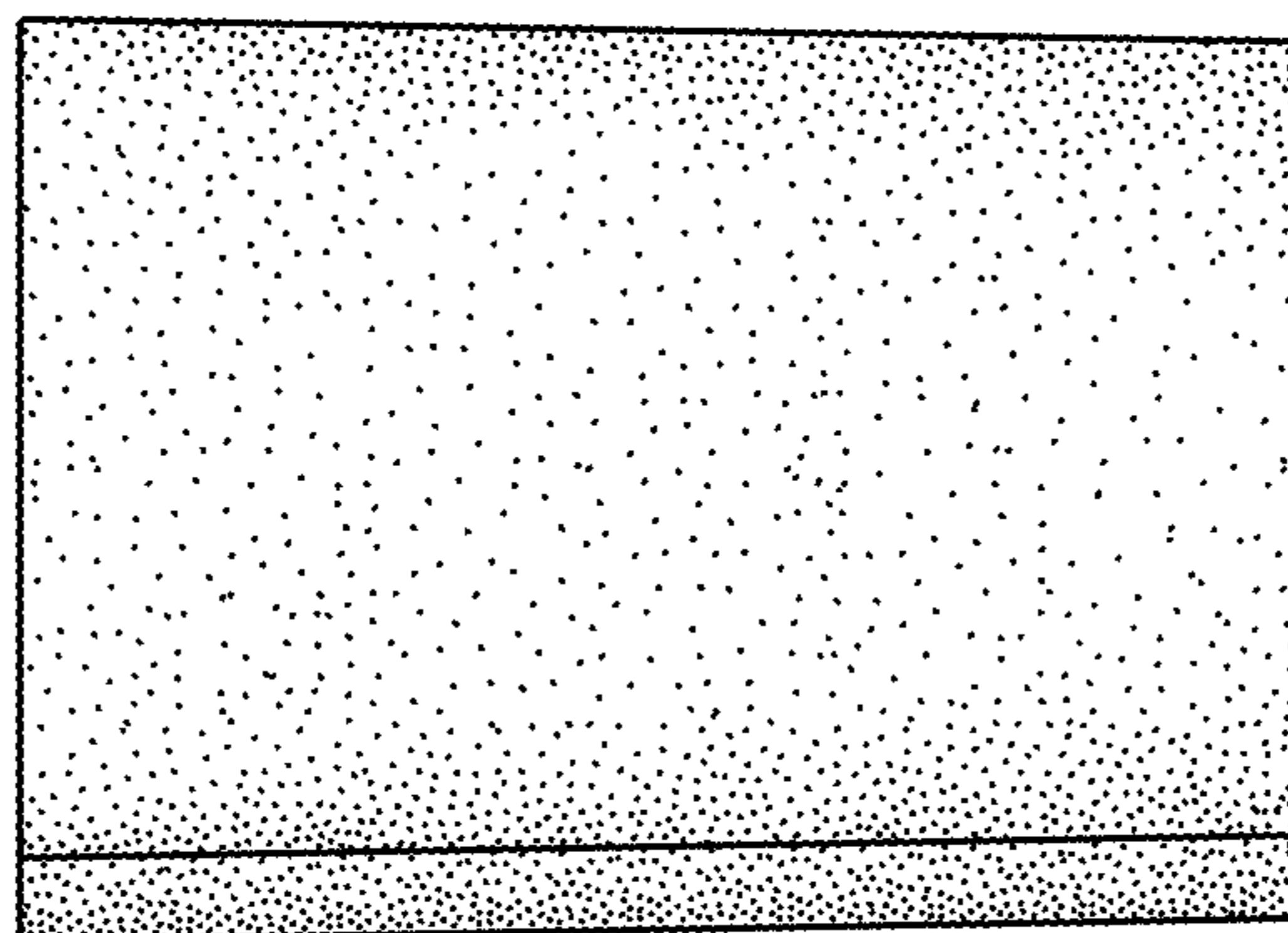

FIG. 4

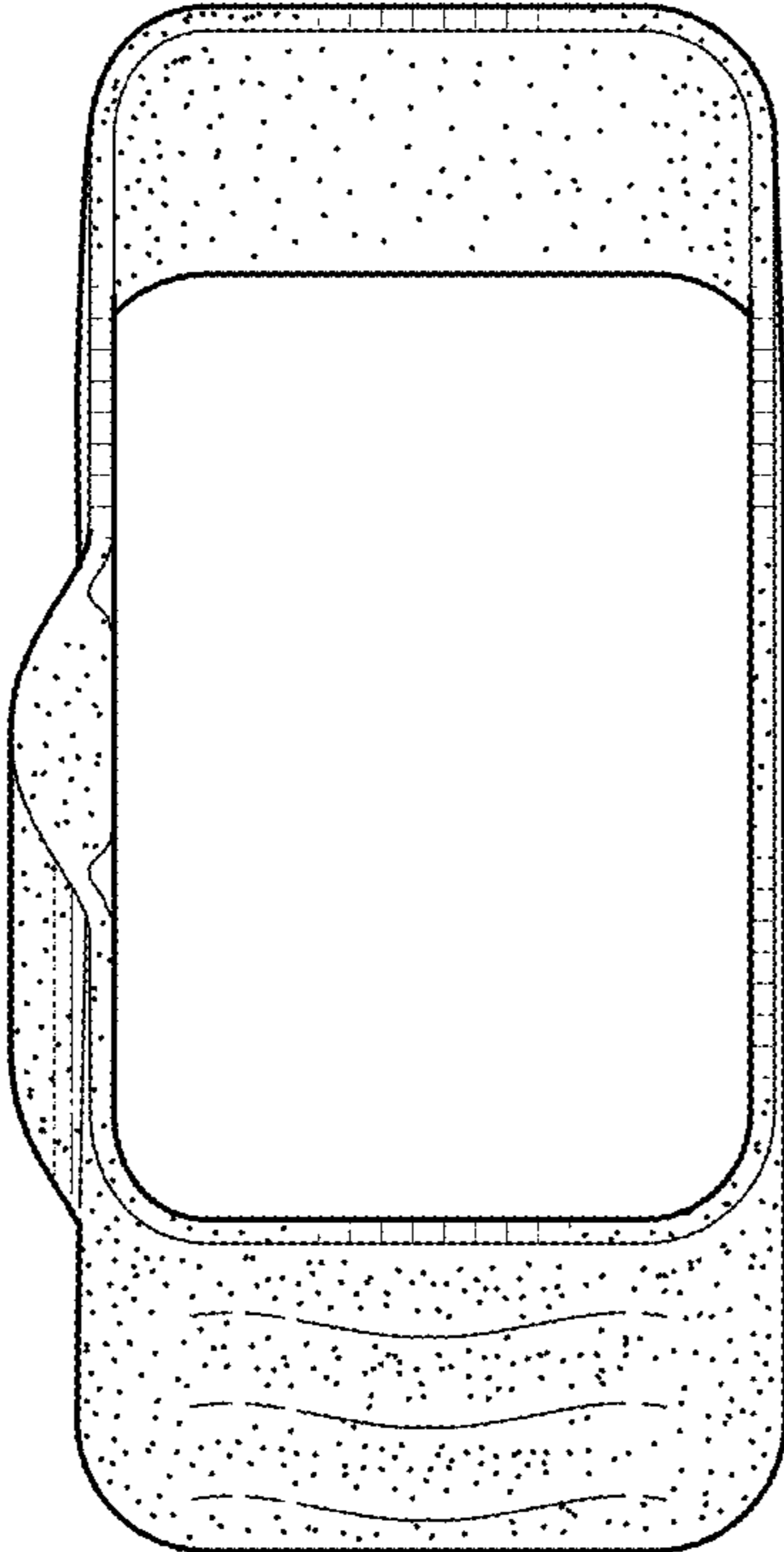

FIG. 7

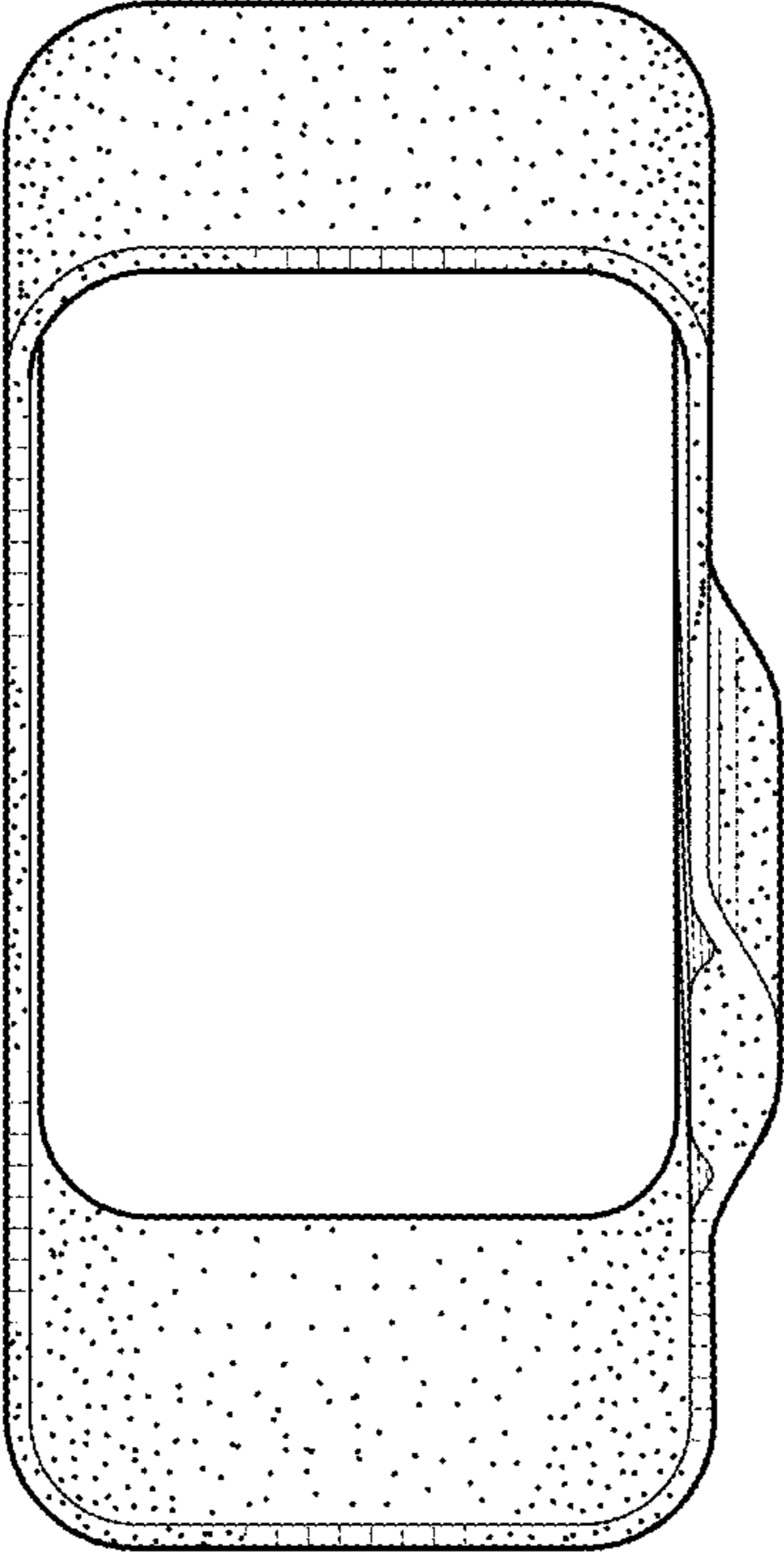

FIG. 6

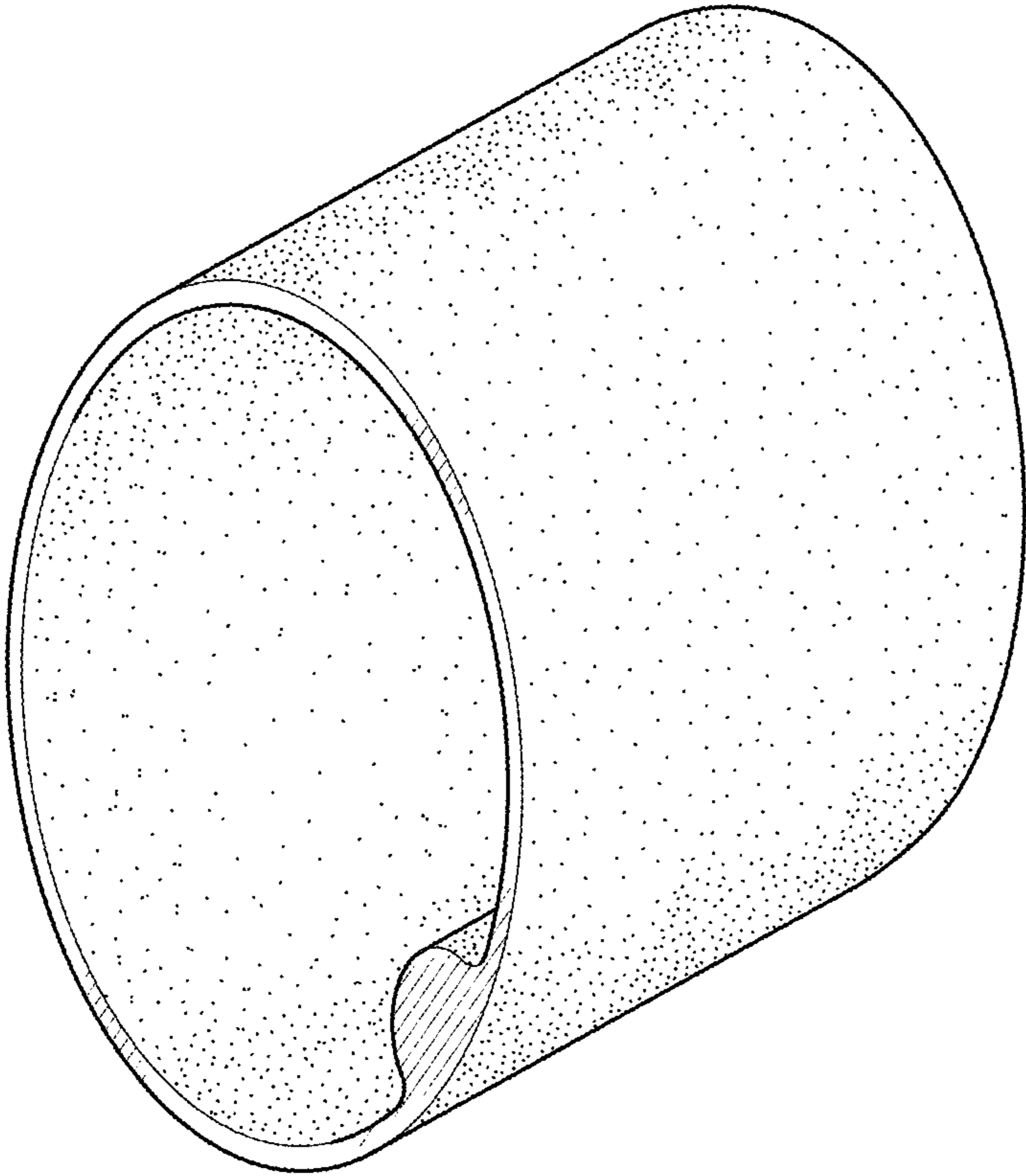

FIG. 8

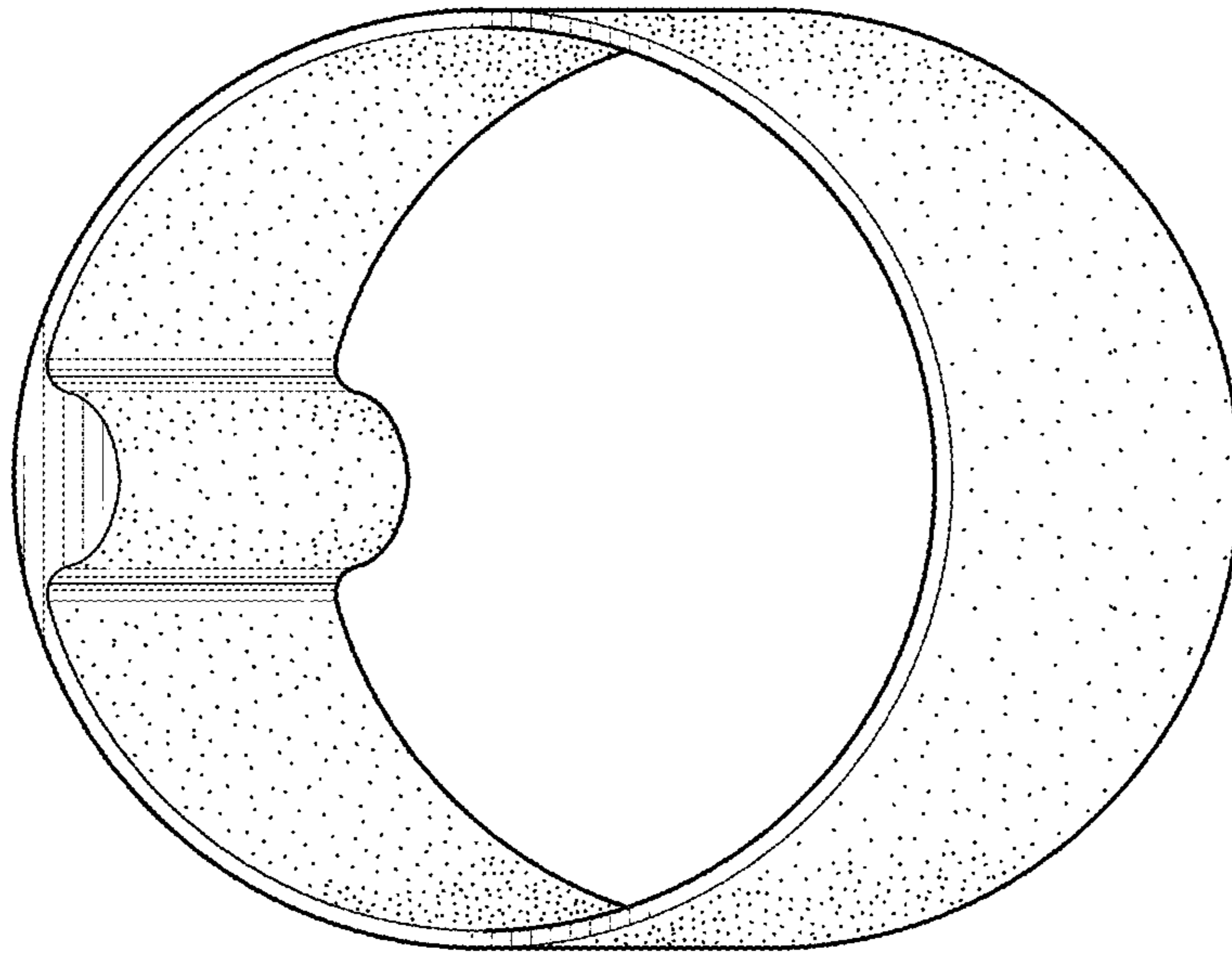

FIG. 10

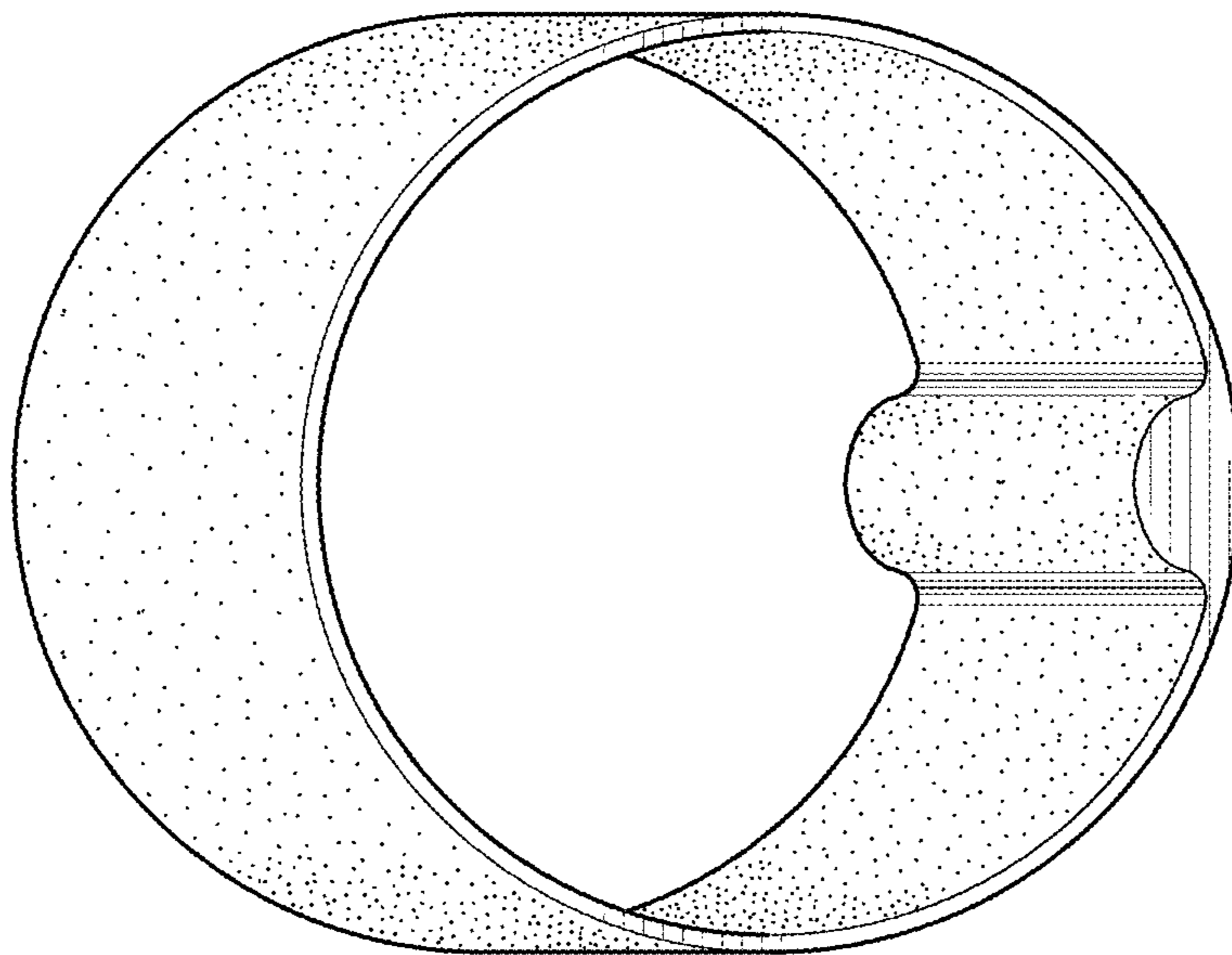

FIG. 9

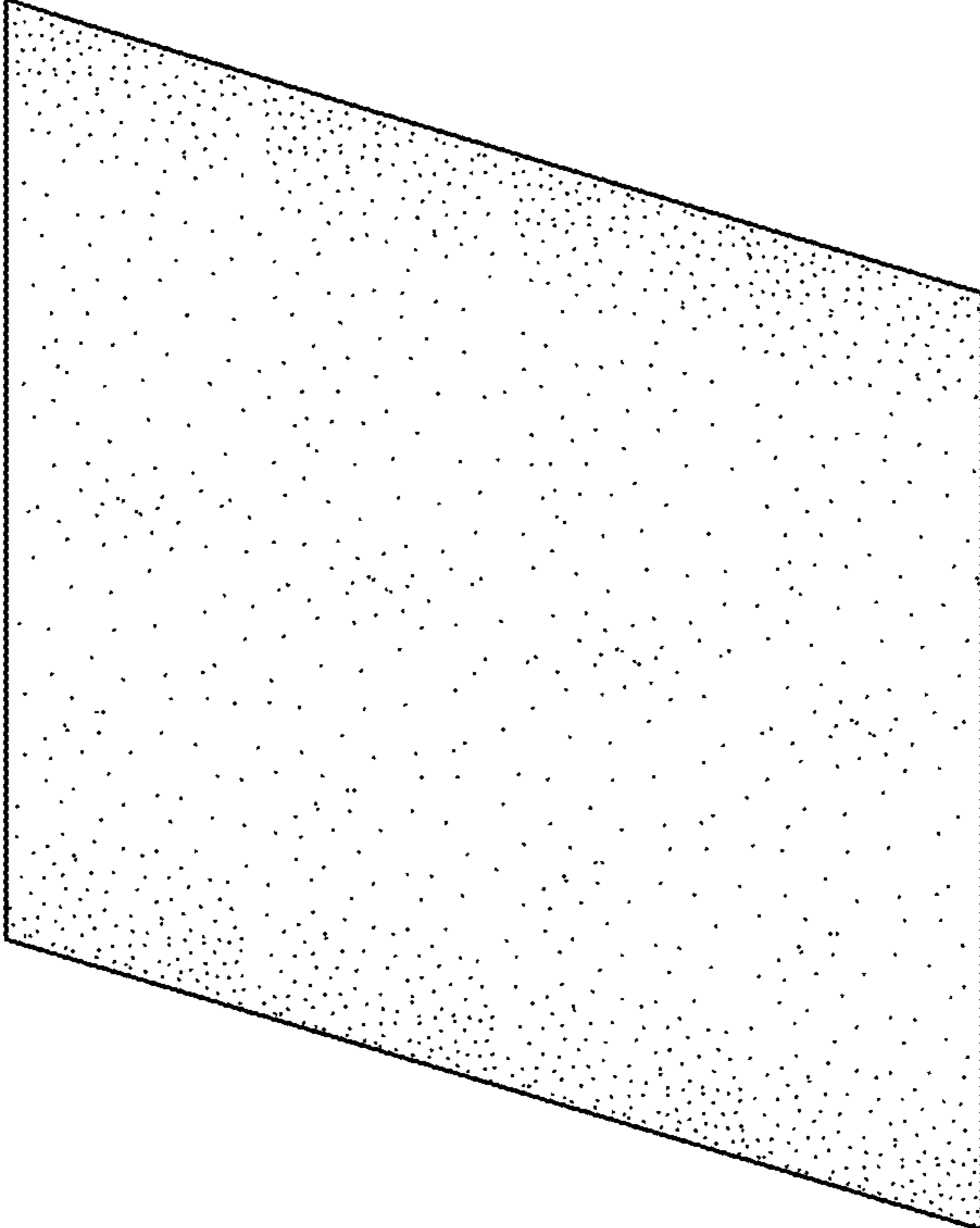

FIG. 12

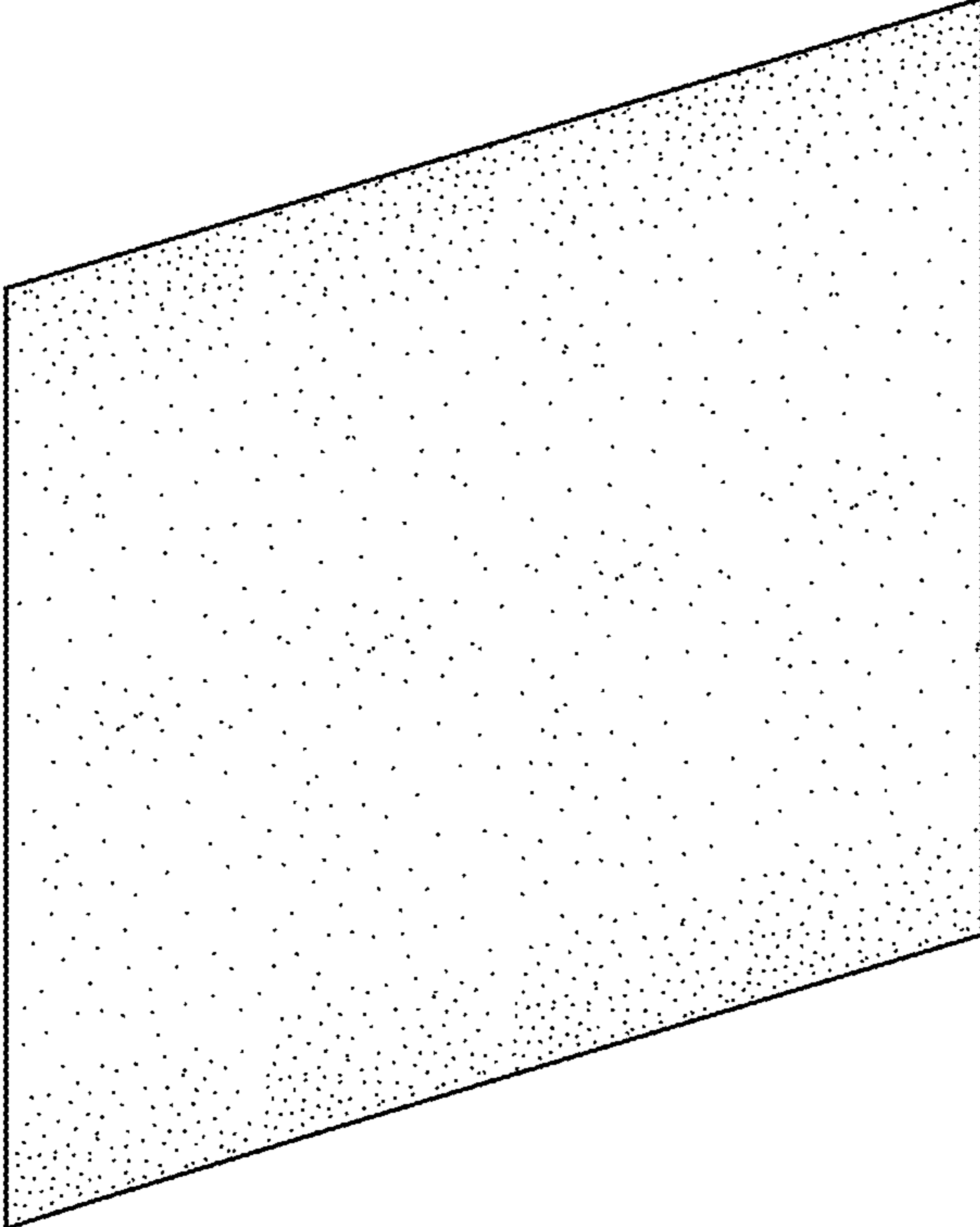

FIG. 11

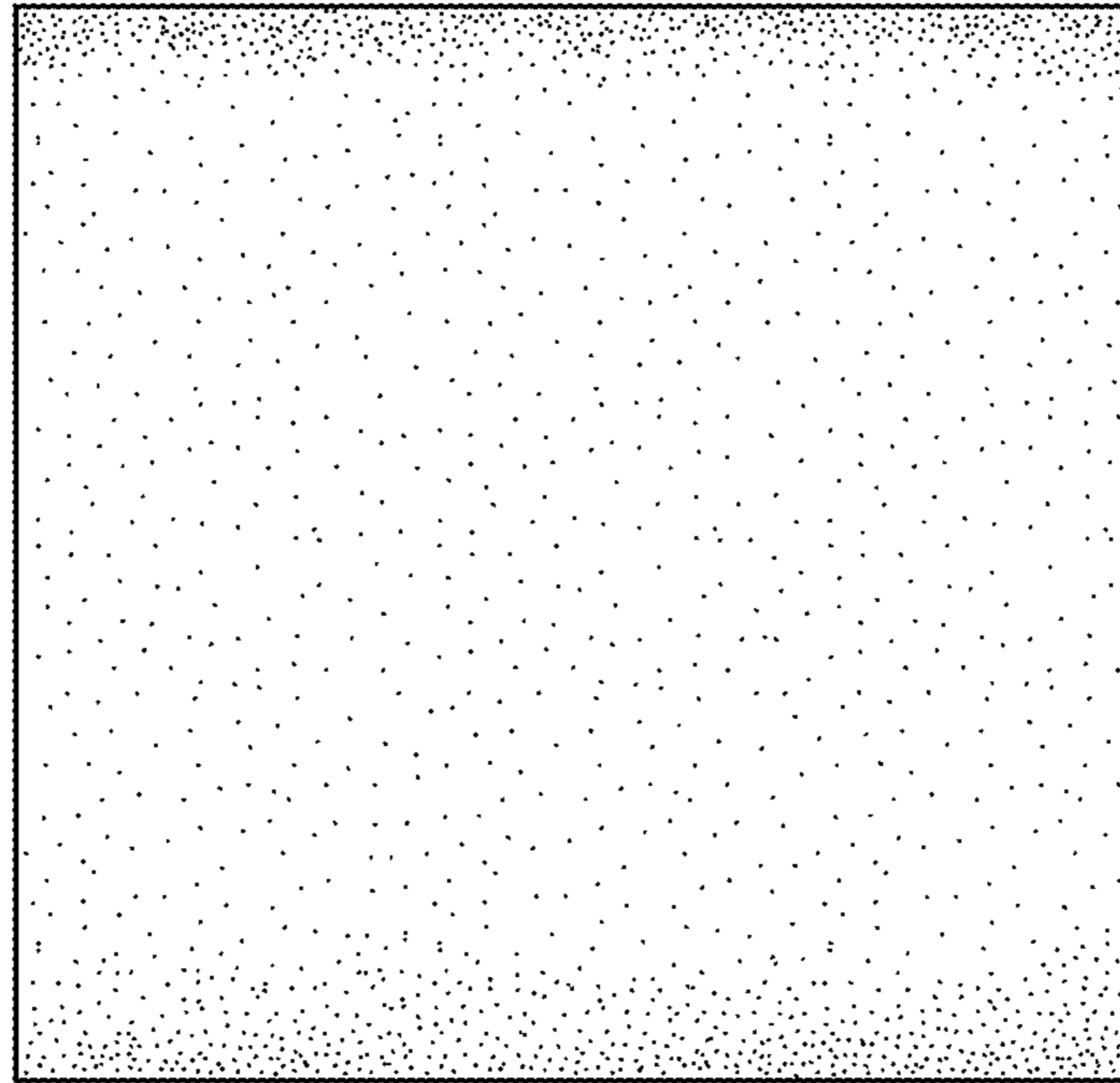

FIG. 14

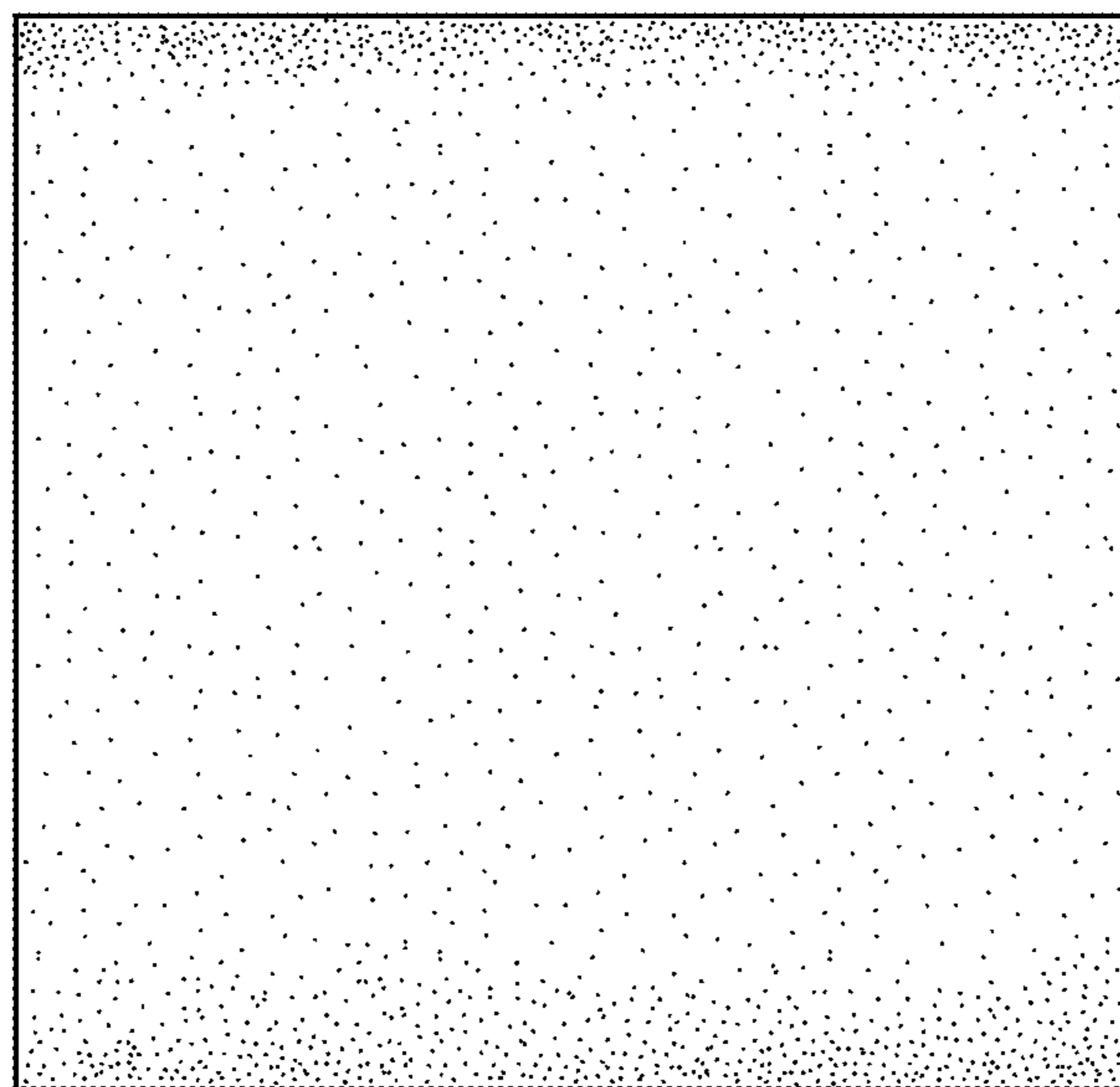

FIG. 13

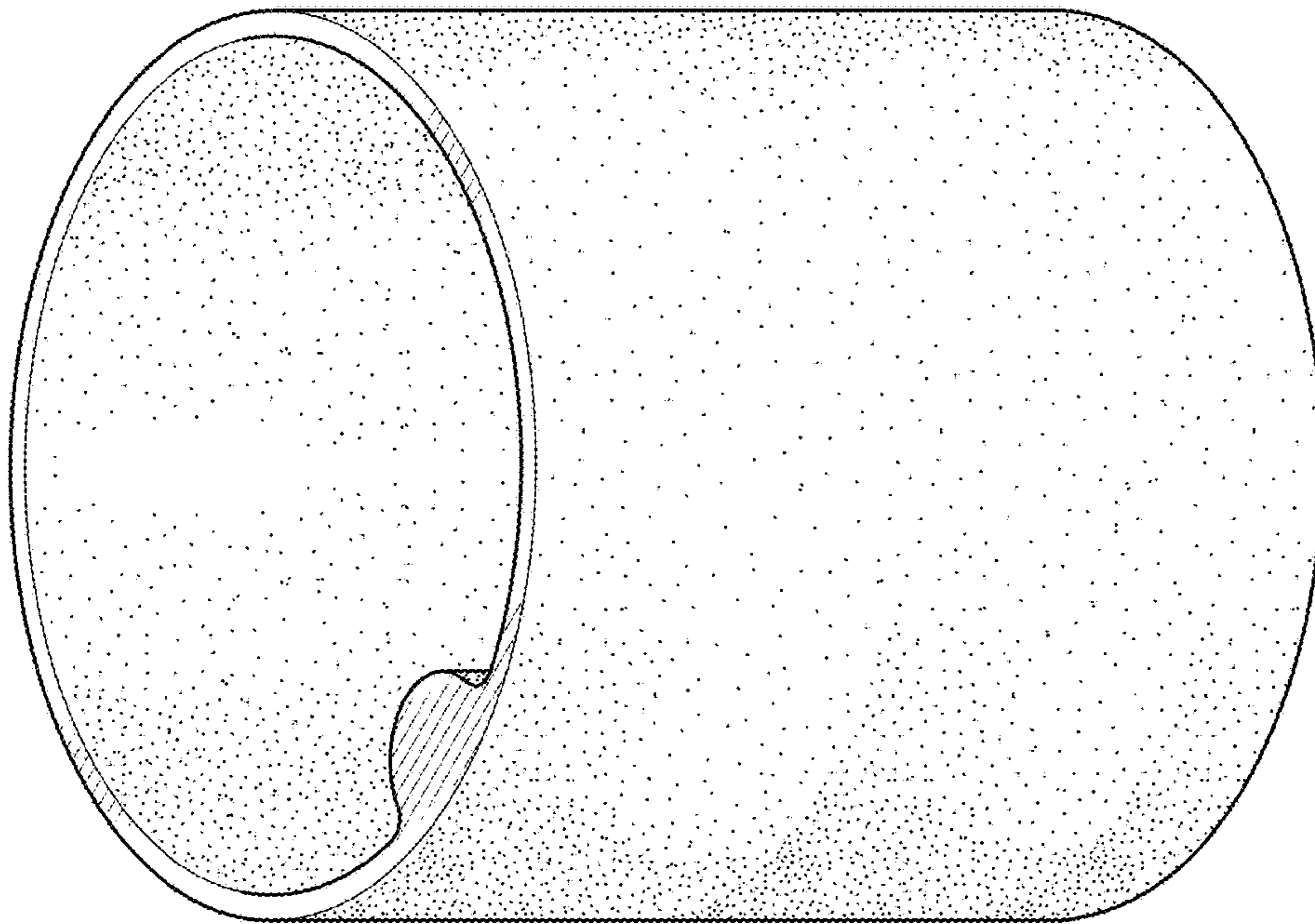

FIG. 15

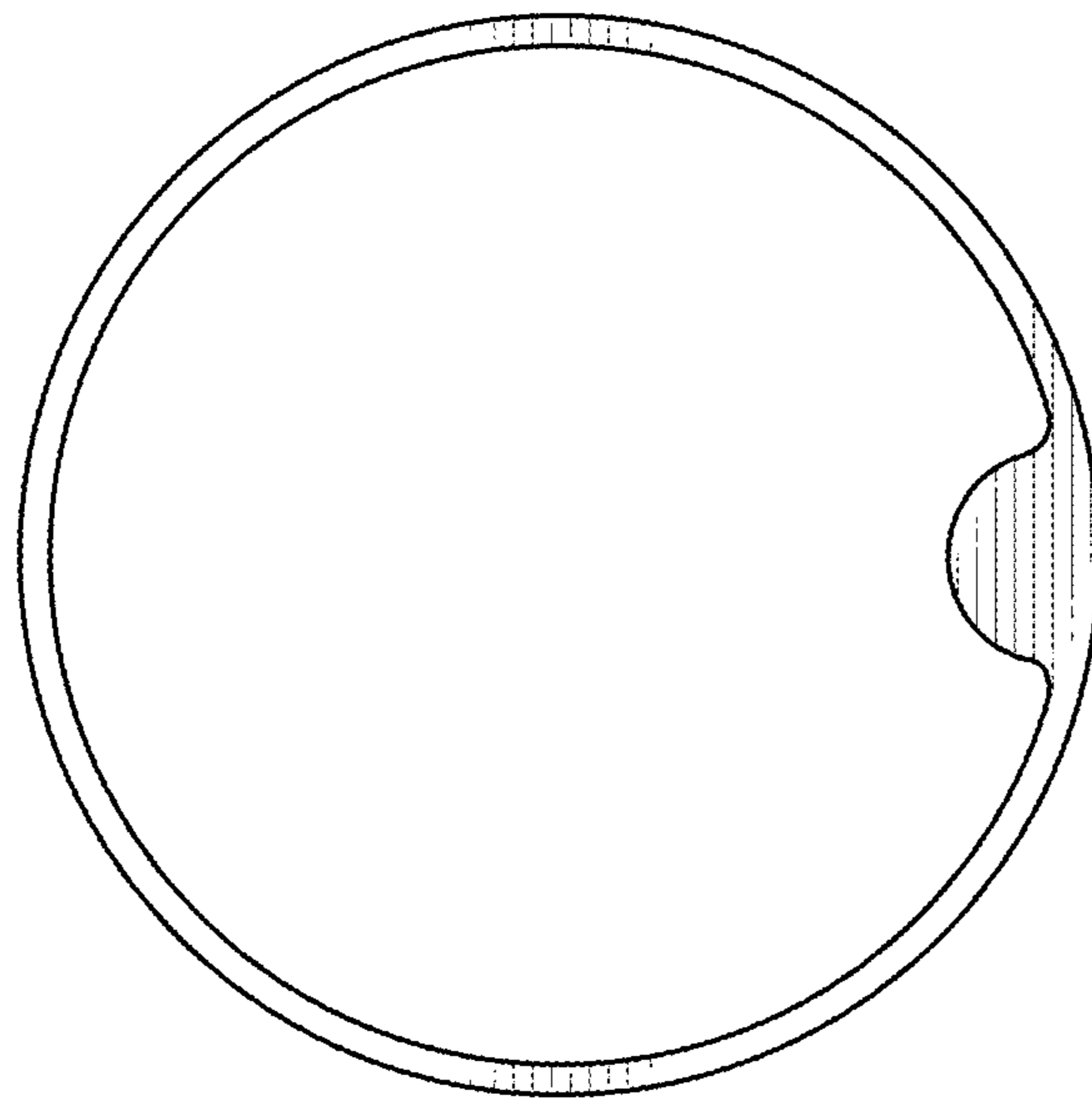

FIG. 17

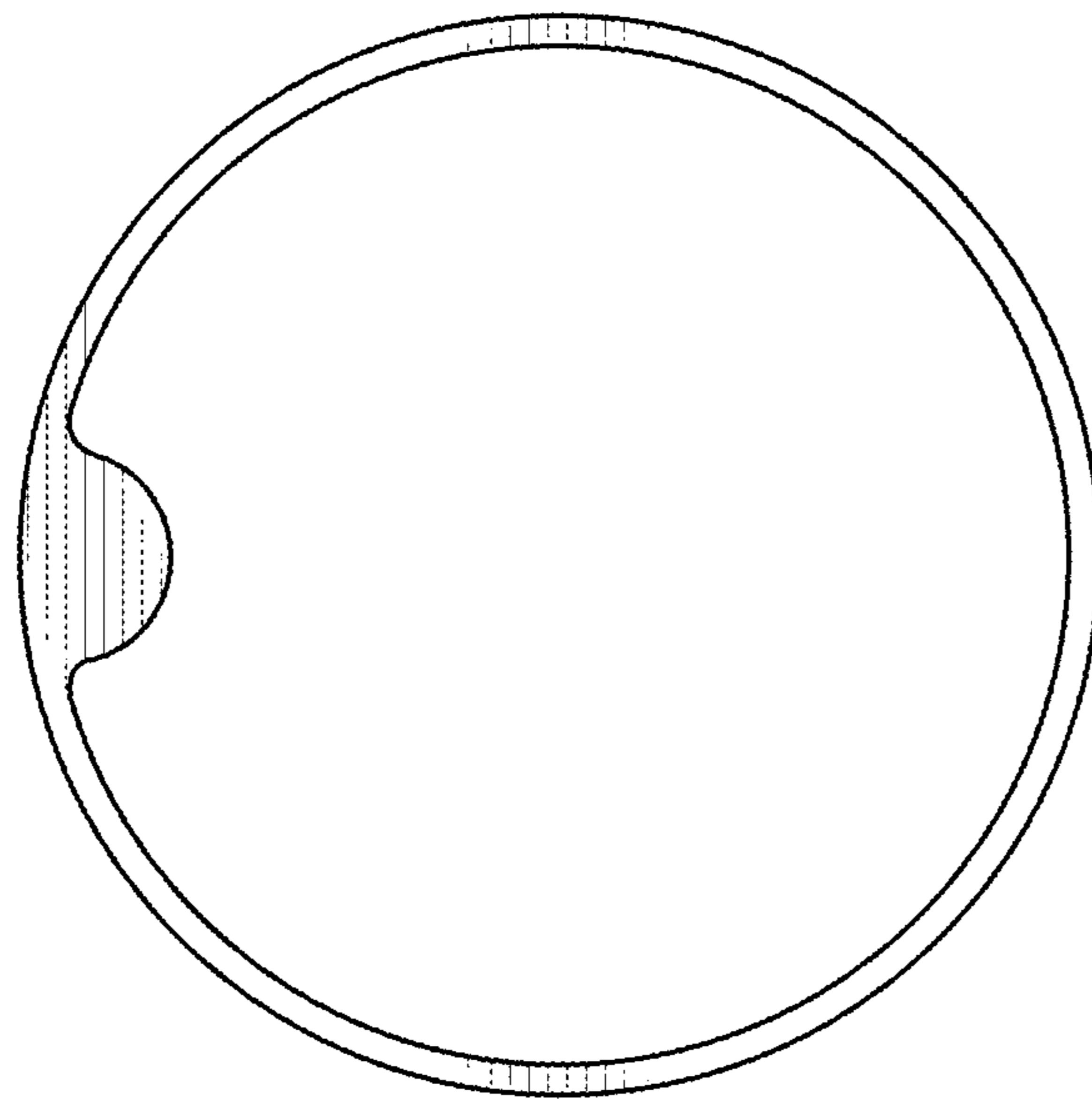

FIG. 16

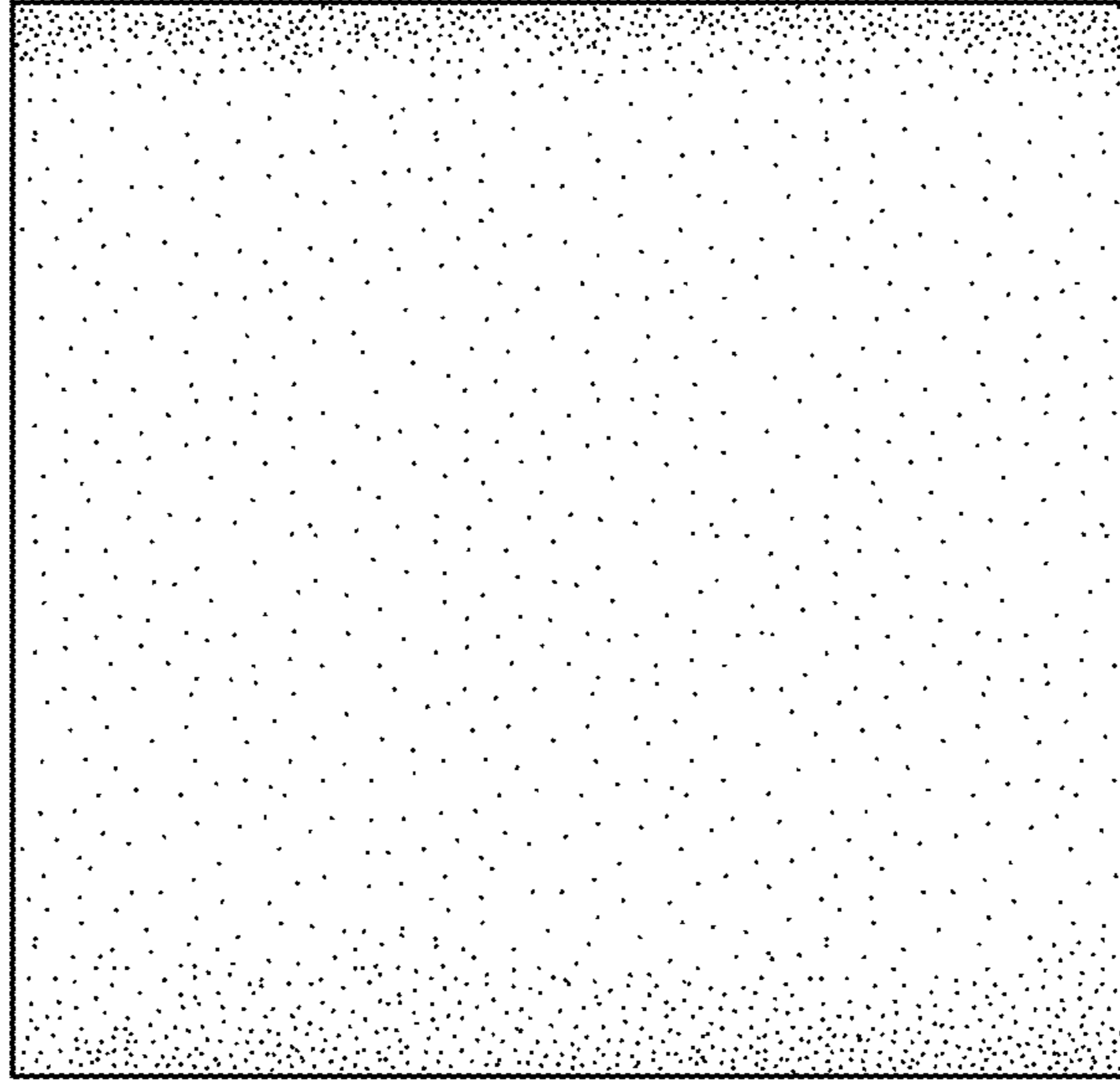

FIG. 19

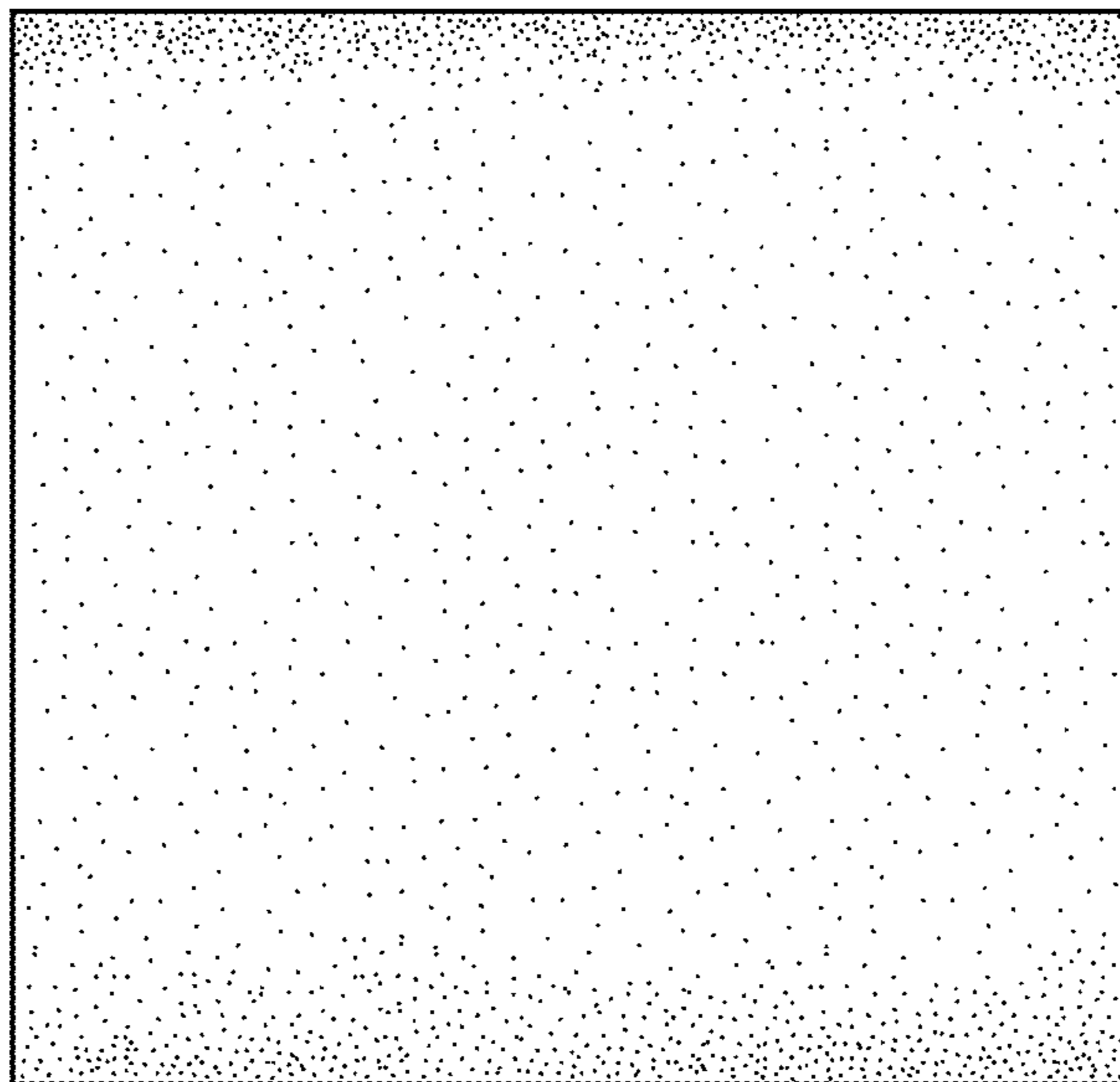

FIG. 18

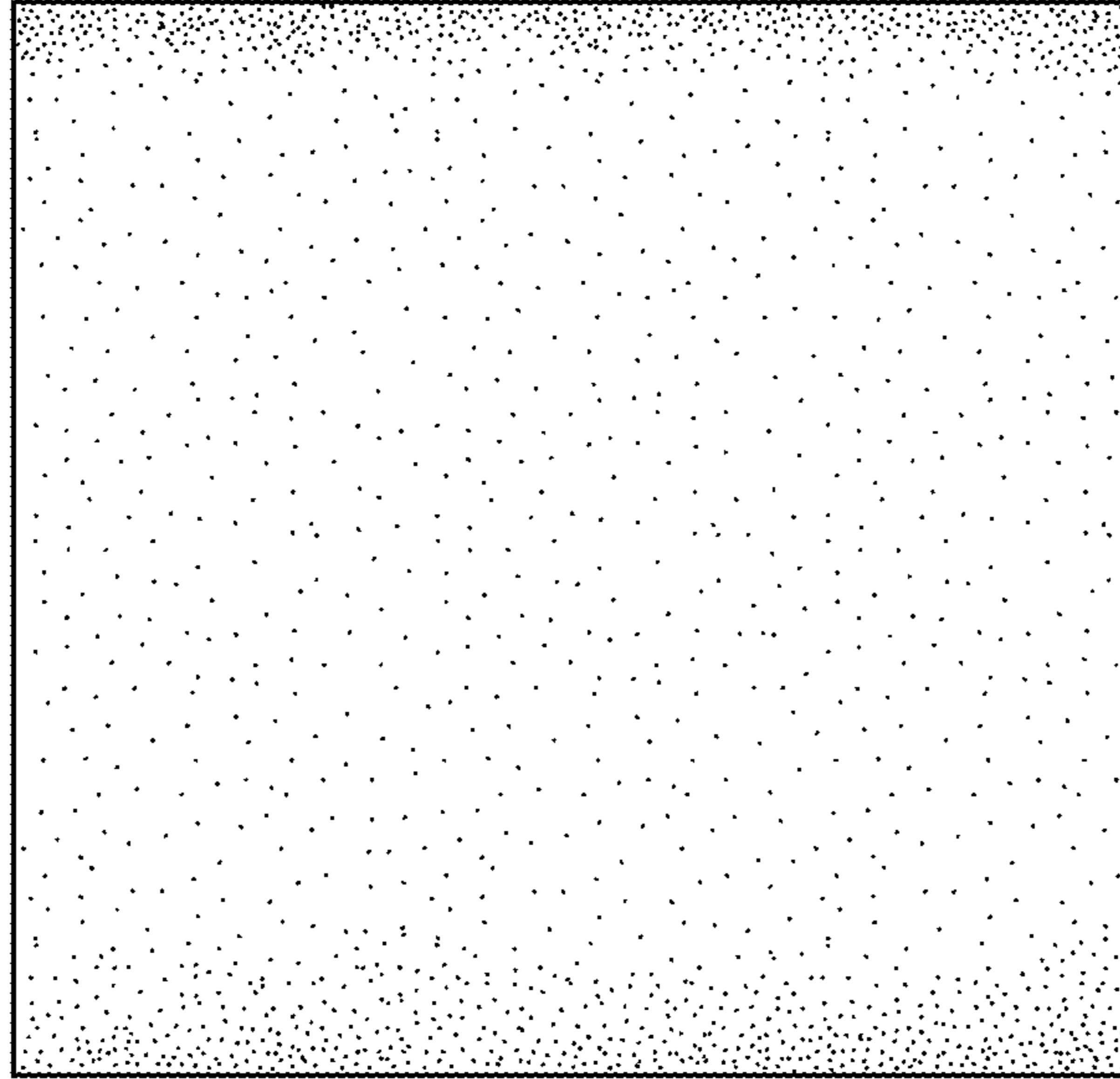

FIG. 21

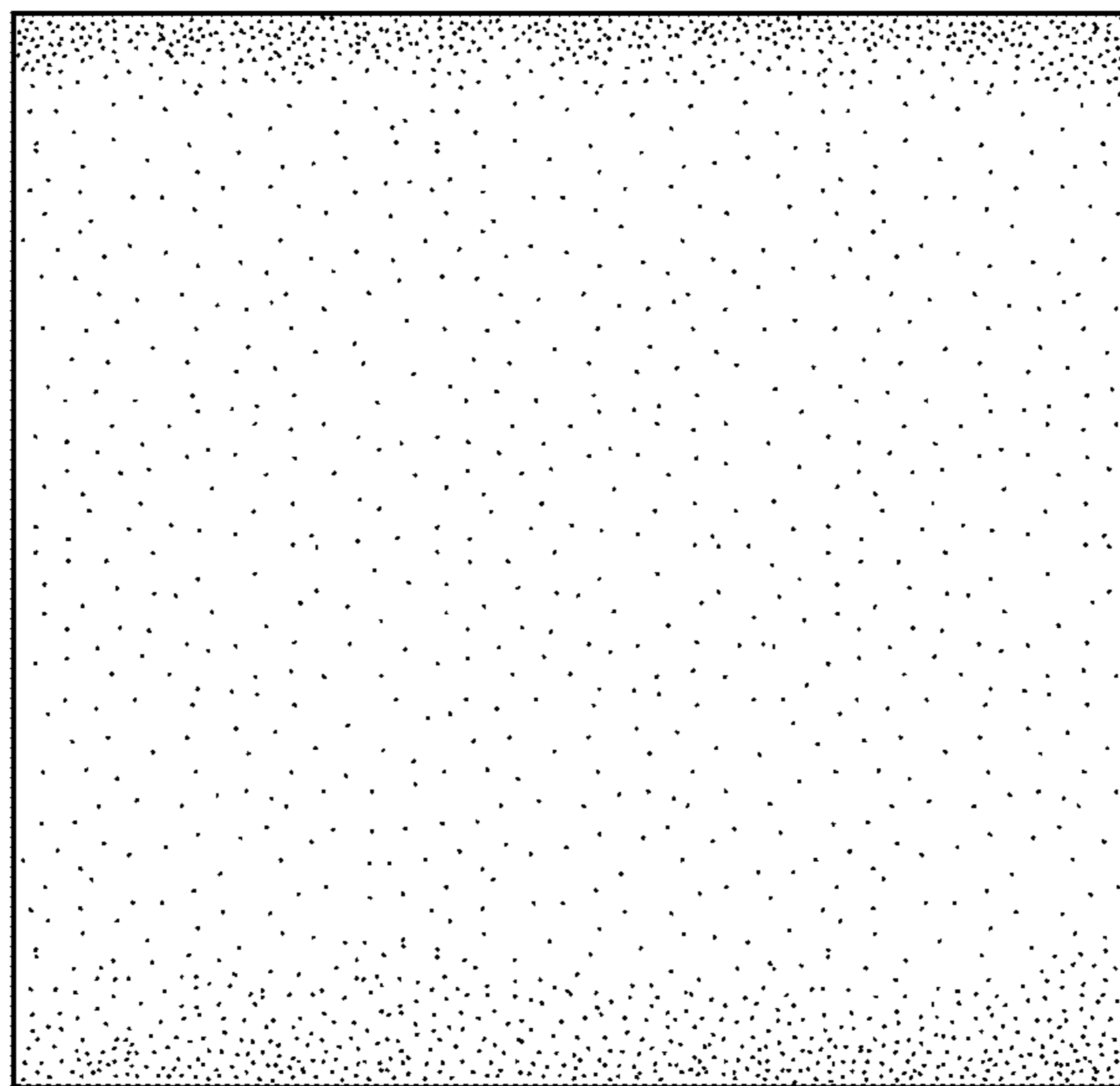

FIG. 20