



US00D813298S

(12) **United States Design Patent**
Lorenzen

(10) **Patent No.:** **US D813,298 S**
(45) **Date of Patent:** **** Mar. 20, 2018**

(54) **FRANKING SYSTEM**

(71) Applicant: **FRANCOTYP-POSTALIA GMBH**,
Berlin (DE)

(72) Inventor: **Matthias Lorenzen**, Berlin (DE)

(73) Assignee: **Francotyp-Postalia GmbH**, Berlin
(DE)

(**) Term: **15 Years**

(21) Appl. No.: **29/565,281**

(22) Filed: **May 19, 2016**

(30) **Foreign Application Priority Data**

Dec. 1, 2015 (EM) 001443378-0001

(51) **LOC (11) Cl.** **18-02**

(52) **U.S. Cl.**
USPC **D18/51; D18/35.1**

(58) **Field of Classification Search**
USPC D18/51, 35.1
CPC G01G 23/20; G07B 2017/00217; G07B
2017/00701; G07B 2017/00709; G07B
2017/00717
See application file for complete search history.

(56) **References Cited**

U.S. PATENT DOCUMENTS

4,956,782 A * 9/1990 Freeman G01G 19/4148
177/25.15
D358,415 S * 5/1995 Klein D18/51
D398,335 S * 9/1998 Friedrich D18/51
6,178,410 B1 * 1/2001 Kunde G07B 17/00193
705/406
6,280,104 B1 * 8/2001 Muller B41J 13/12
101/91
6,322,663 B1 * 11/2001 Muller B43M 5/042
156/441.5
D452,266 S * 12/2001 Weirsmann D18/51

(Continued)

FOREIGN PATENT DOCUMENTS

DE EP 0974819 A2 * 1/2000 G01G 19/005
DE EP 2360458 A2 * 8/2011 G01G 19/005

OTHER PUBLICATIONS

YouTube. <URL: <https://www.youtube.com/watch?v=MAY66L8iaFQ>>. Nov. 18, 2010. Neopost IM-16.*

(Continued)

Primary Examiner — Bridget L. Eland

Assistant Examiner — Lauren McVey

(74) *Attorney, Agent, or Firm* — Laurence A. Greenberg;
Werner H. Stemer; Ralph E. Locher

(57) **CLAIM**

The ornamental design for a franking system, as shown and described.

DESCRIPTION

FIG. 1 is a front perspective view of the franking system showing my new invention;
FIG. 2 is an enlarged right side elevation view thereof;
FIG. 3 is an enlarged left side elevation view thereof;
FIG. 4 is a top plan view thereof;
FIG. 5 is a front elevation view thereof; and,
FIG. 6 is a rear elevation view thereof.

The broken lines immediately adjacent the claim represent the bounds of the claimed design while all other broken lines are directed to environment and are for illustrative purposes only; the broken lines form no part of the claimed design.

The bottom surface of the franking system has not been claimed. The wire frame lines shown throughout the views are intended to indicate surface contour.

The "FP" lettering and icon forming part of the disclosure is a registered trademark, Registration No. 3605090, of FRANCOTYP-POSTALIA GMBH.

1 Claim, 6 Drawing Sheets

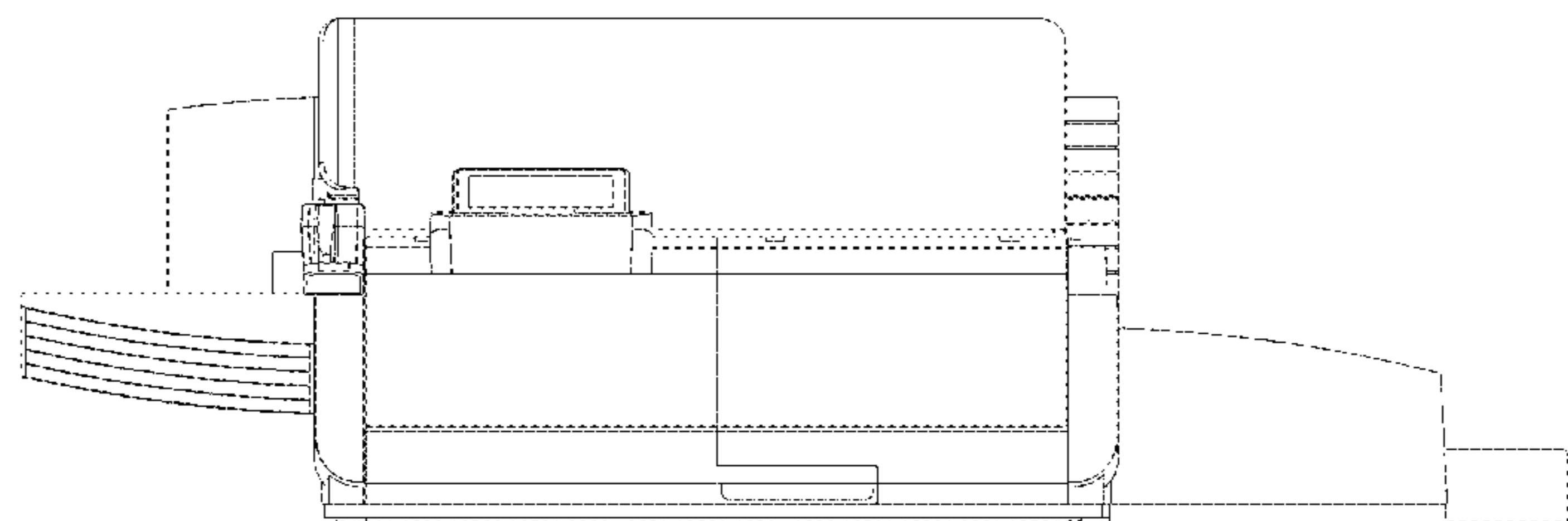
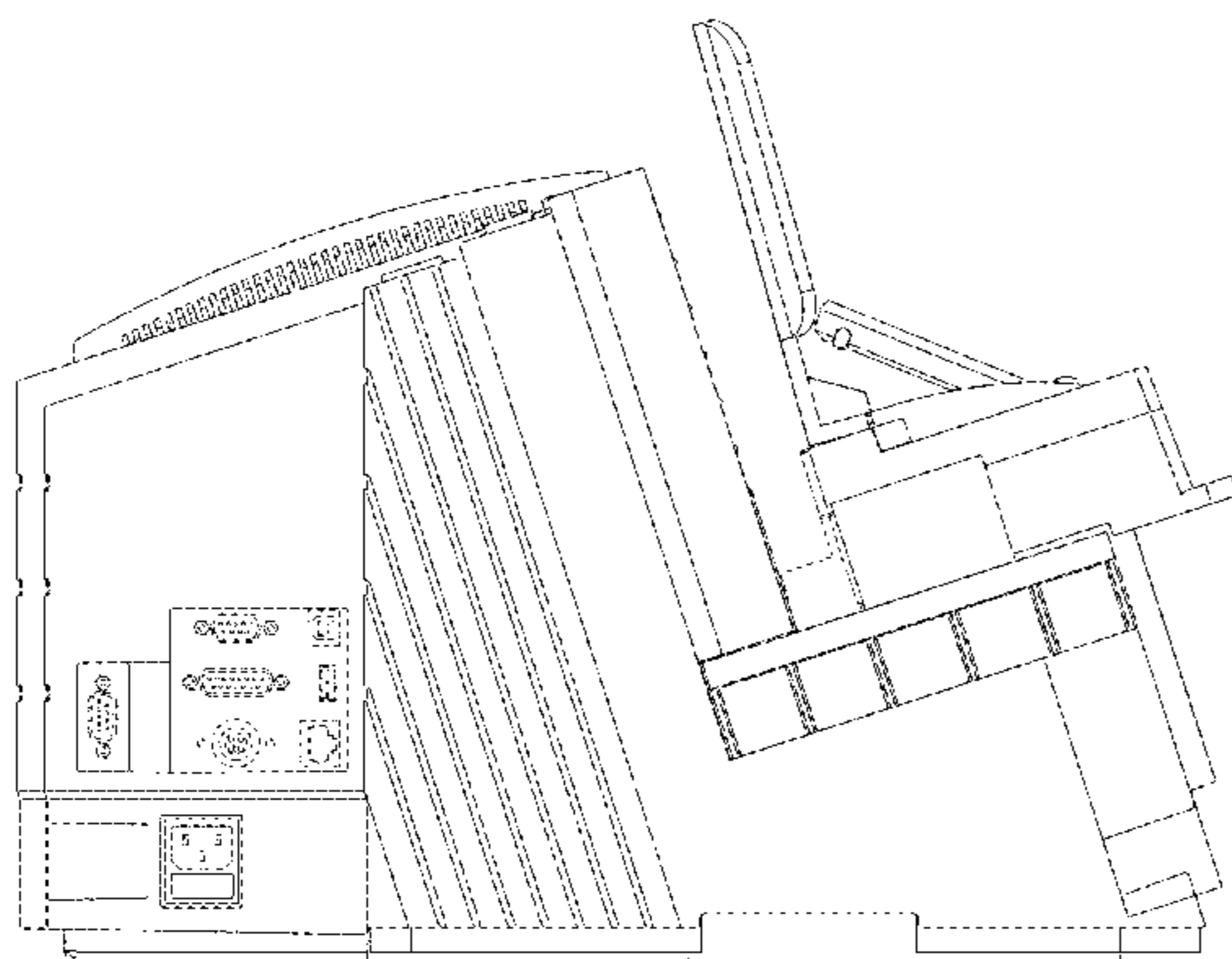

(56)

References Cited

U.S. PATENT DOCUMENTS

6,353,192 B1 * 3/2002 Thiel G01G 19/4148
177/121
6,630,632 B2 * 10/2003 Huebler G01G 19/005
177/25.15
D505,448 S * 5/2005 Huebler D18/51
D505,449 S * 5/2005 Huebler D18/51
D506,497 S * 6/2005 Huebler D18/51
6,907,409 B1 * 6/2005 Huebler G01G 19/005
177/185
6,978,255 B1 * 12/2005 Pauschinger B41J 2/17546
347/32
D587,298 S * 2/2009 Hubler D18/35.1
D587,299 S * 2/2009 Hubler D18/35.1
D587,300 S * 2/2009 Hubler D18/35.1
D587,301 S * 2/2009 Hubler D18/35.1
D587,302 S * 2/2009 Hubler D18/35.1
D587,747 S * 3/2009 Hubler D18/35.1
D589,082 S * 3/2009 Hubler D18/35.1
D596,224 S * 7/2009 Hubler D18/35.1
D602,075 S * 10/2009 Sugrue D18/51
D633,138 S * 2/2011 Sugrue D18/51
D689,130 S * 9/2013 Lorenzen D18/35.1
D689,132 S * 9/2013 Lorenzen D18/35.1

OTHER PUBLICATIONS

YouTube. <URL: <https://www.youtube.com/watch?v=Y4wu9SOdn0w>>. Oct. 30, 2015. Pitney Bowes DM60 Digital Mailing System.*

* cited by examiner

FIG. 1

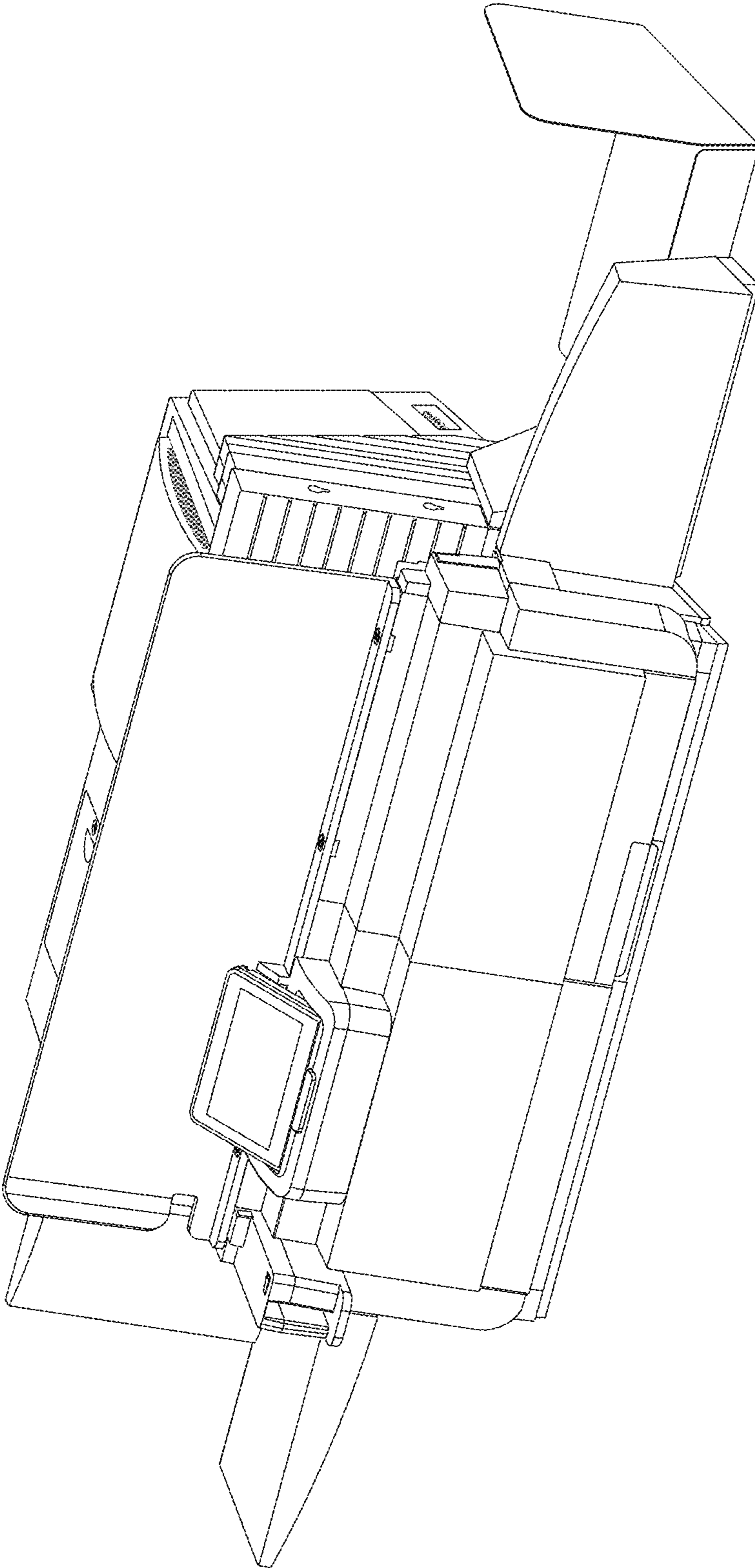

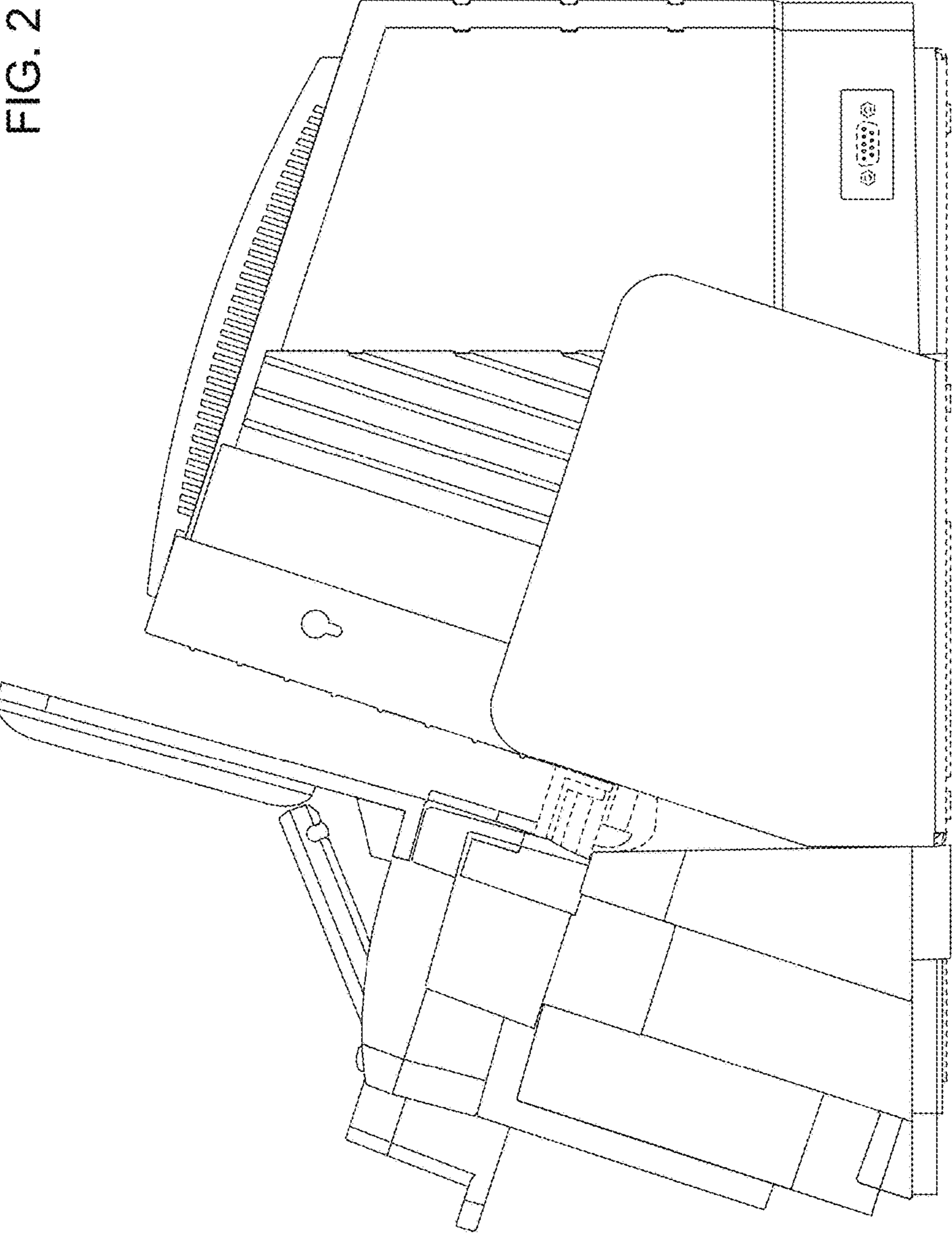

FIG. 2

FIG. 3

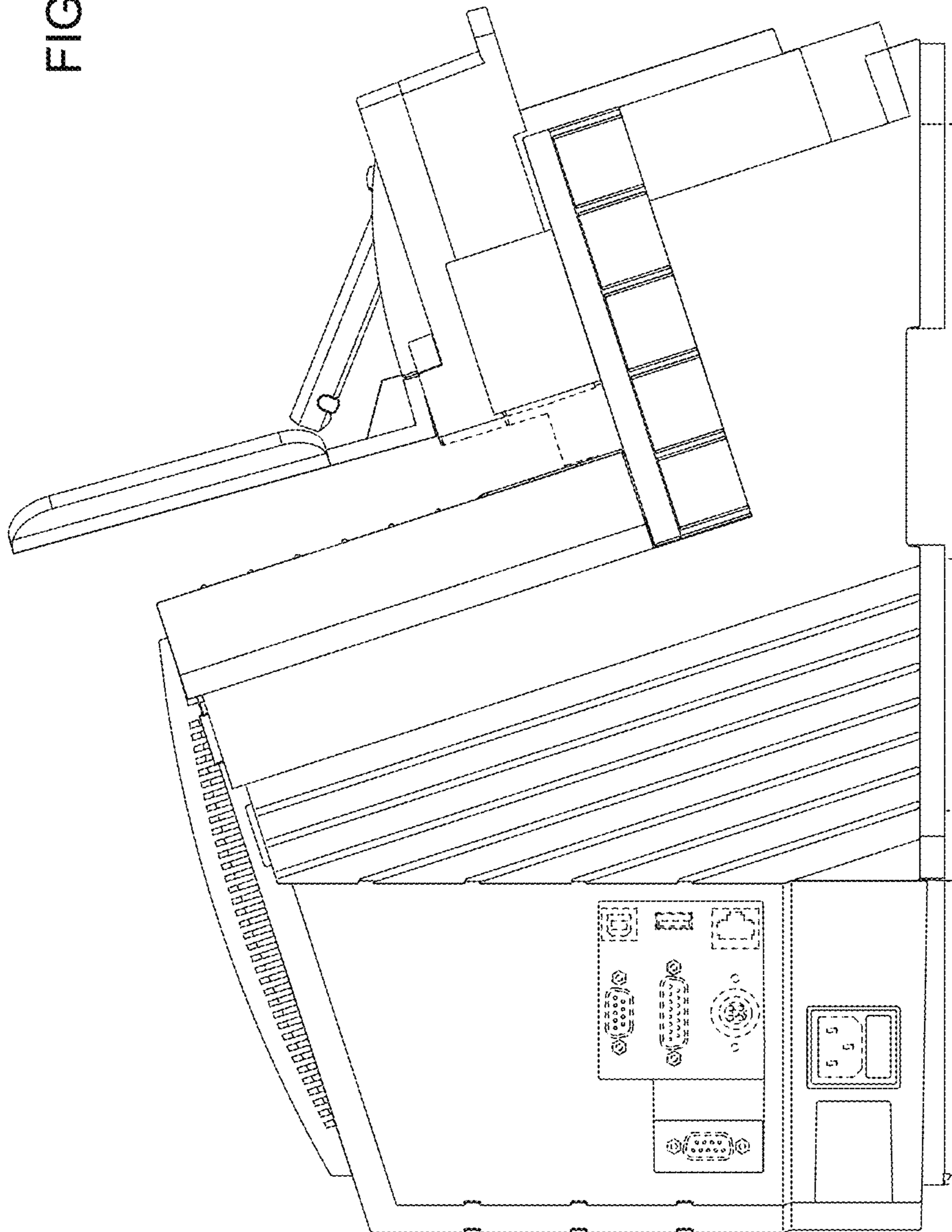

FIG. 4

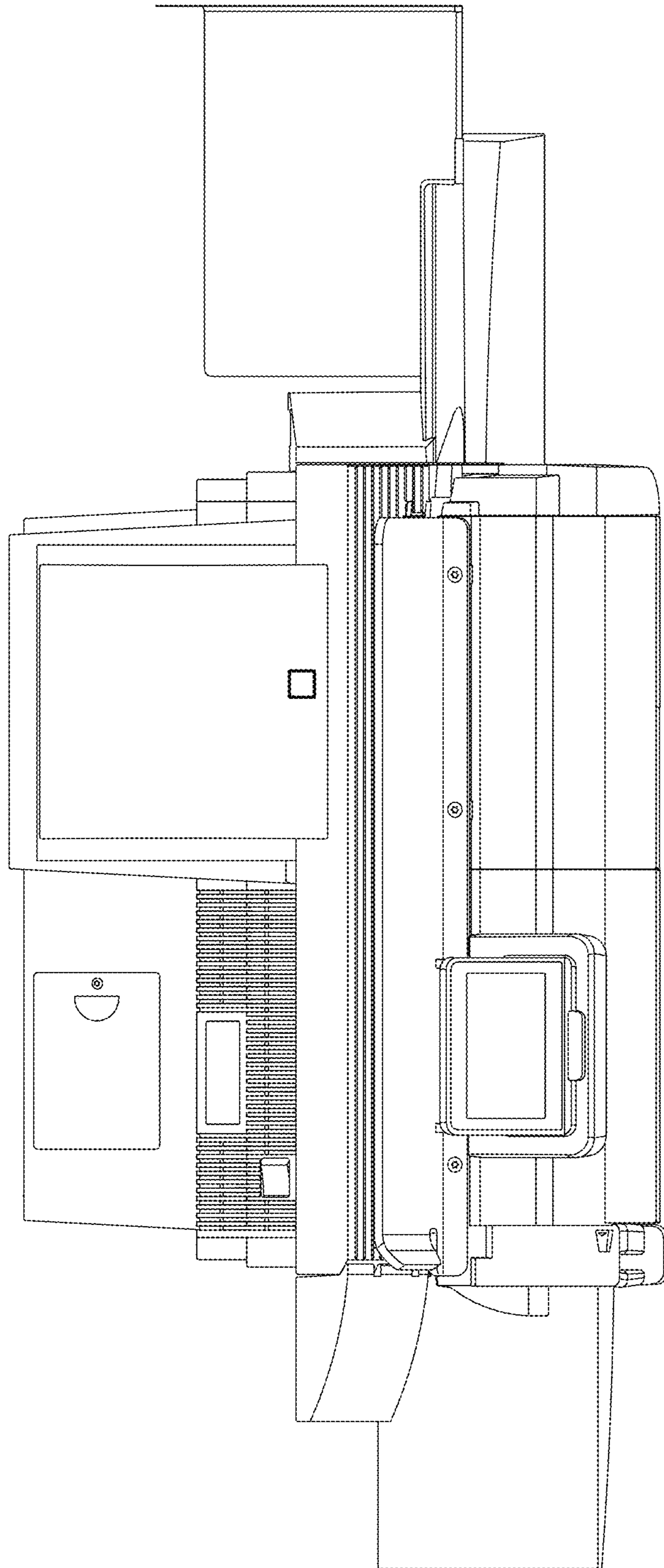

FIG. 5

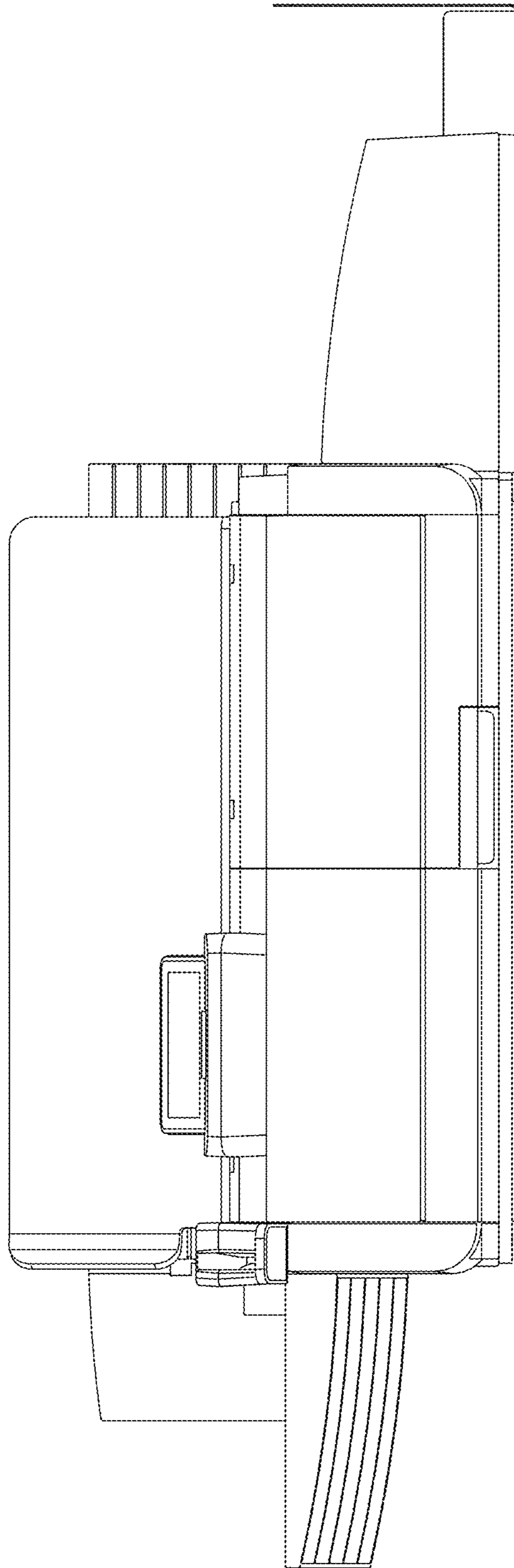

FIG. 6

