



US00D813170S

(12) **United States Design Patent**
Chan et al.

(10) **Patent No.:** **US D813,170 S**
(45) **Date of Patent:** **** Mar. 20, 2018**

(54) **PLUG**
(71) Applicant: **Amphenol Corporation**, Wallingford Center, CT (US)
(72) Inventors: **David Chan**, Xiamen (CN); **Wonder Wang**, Xiamen (CN); **Bob Tang**, Xiamen (CN); **Martin Li**, Xiamen (CN); **Smith Wu**, Xiamen (CN); **Jason Si**, Toronto (CA); **Sam Kocsis**, Nashua, NH (US); **Ba Pham**, Toronto (CA); **Brian Kirk**, Amherst, NH (US)

(73) Assignee: **Amphenol Corporation**, Wallingford, CT (US)

(**) Term: **15 Years**

(21) Appl. No.: **29/575,279**

(22) Filed: **Aug. 23, 2016**

(51) **LOC (11) Cl.** **13-03**

(52) **U.S. Cl.**
USPC **D13/147**

(58) **Field of Classification Search**
USPC D13/133, 146, 147, 154, 156, 184, 199;
D14/432, 433, 434, 435.1, 438
CPC H01R 12/64; H01R 12/71; H01R 13/5219;
H01R 13/6581; H01R 13/6596; H01R
13/6873; H01R 13/748
See application file for complete search history.

(56) **References Cited**

U.S. PATENT DOCUMENTS

D322,604 S	12/1991	Komatsu	
D580,359 S	* 11/2008	Su	D13/147
D583,766 S	* 12/2008	Chiang	D13/147
D598,862 S	* 8/2009	Chen	D13/147
D601,505 S	* 10/2009	Fukazawa	D13/147
D626,077 S	* 10/2010	Huang	D13/147
D671,896 S	* 12/2012	Wang	D13/147

D698,733 S	2/2014	Yokoyama	
D698,734 S	2/2014	Yokoyama	
D699,192 S	2/2014	Takenaga et al.	
D703,615 S	4/2014	Takenaga et al.	
D706,221 S	6/2014	Grant et al.	
D719,922 S	* 12/2014	Yokoyama	D13/147
D721,657 S	1/2015	Yamaguchi	
D722,026 S	* 2/2015	Yokoyama	D13/147

(Continued)

FOREIGN PATENT DOCUMENTS

CN	203574938 U	4/2014
TW	D152287 S1	4/2012
TW	D172199 S1	6/2014

OTHER PUBLICATIONS

U.S. Appl. No. 29/575,635, filed Aug. 26, 2016, Chan et al.
U.S. Appl. No. 29/575,639, filed Aug. 26, 2016, Chan et al.

Primary Examiner — Daniel Bui

(74) *Attorney, Agent, or Firm* — Wolf, Greenfield & Sacks, P.C.

(57) **CLAIM**

The ornamental design for a plug, as shown and described.

DESCRIPTION

FIG. 1 is a top, front, right side perspective view of a plug showing our new design;

FIG. 2 is a front elevation view thereof;

FIG. 3 is a rear elevation view thereof;

FIG. 4 is a left side elevation view thereof;

FIG. 5 is a right side elevation view thereof;

FIG. 6 is a top plan view thereof; and,

FIG. 7 is a bottom plan view thereof.

The dashed broken lines of the figures represent portions of the plug that form no part of the claimed design. The dash-dot broken lines define boundaries of the claimed design, and form no part of the claimed design.

1 Claim, 7 Drawing Sheets

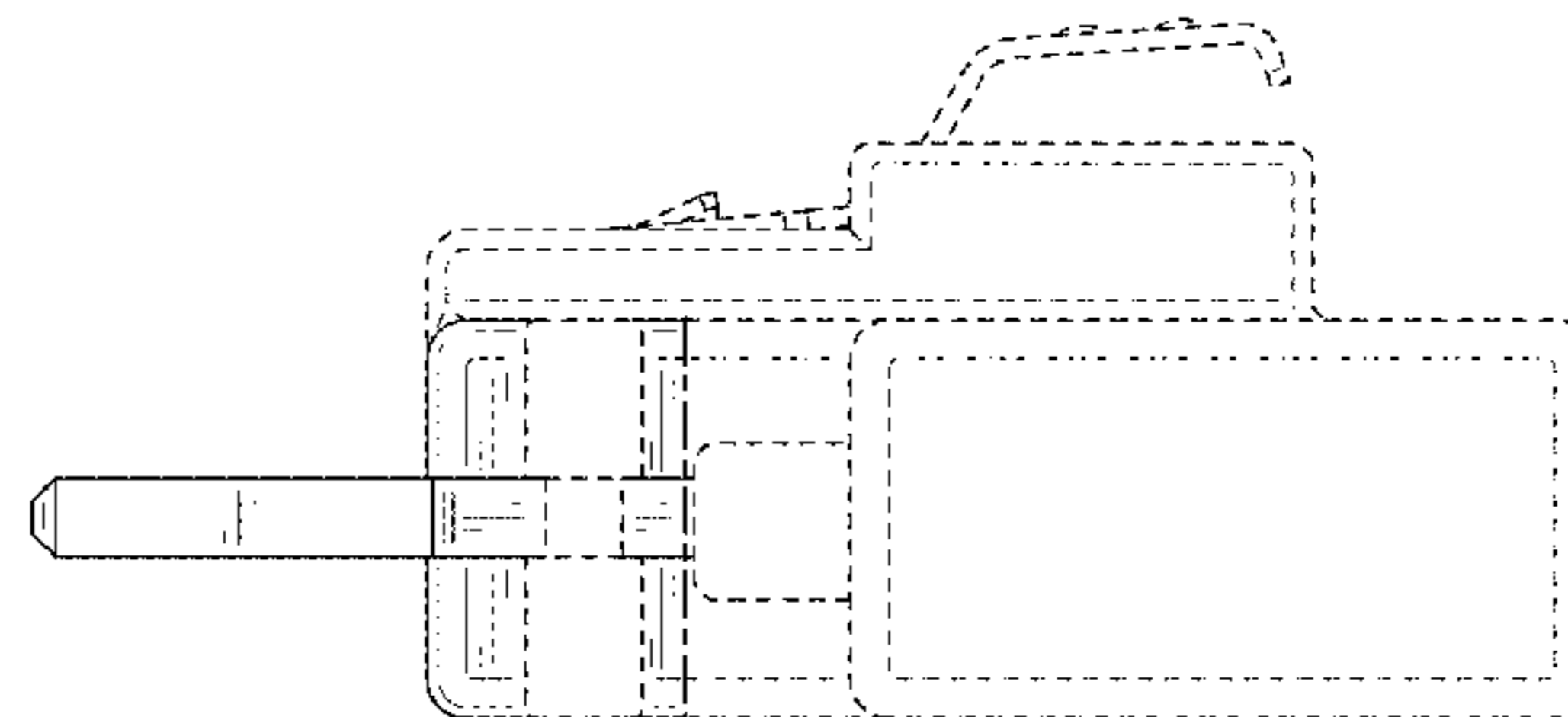
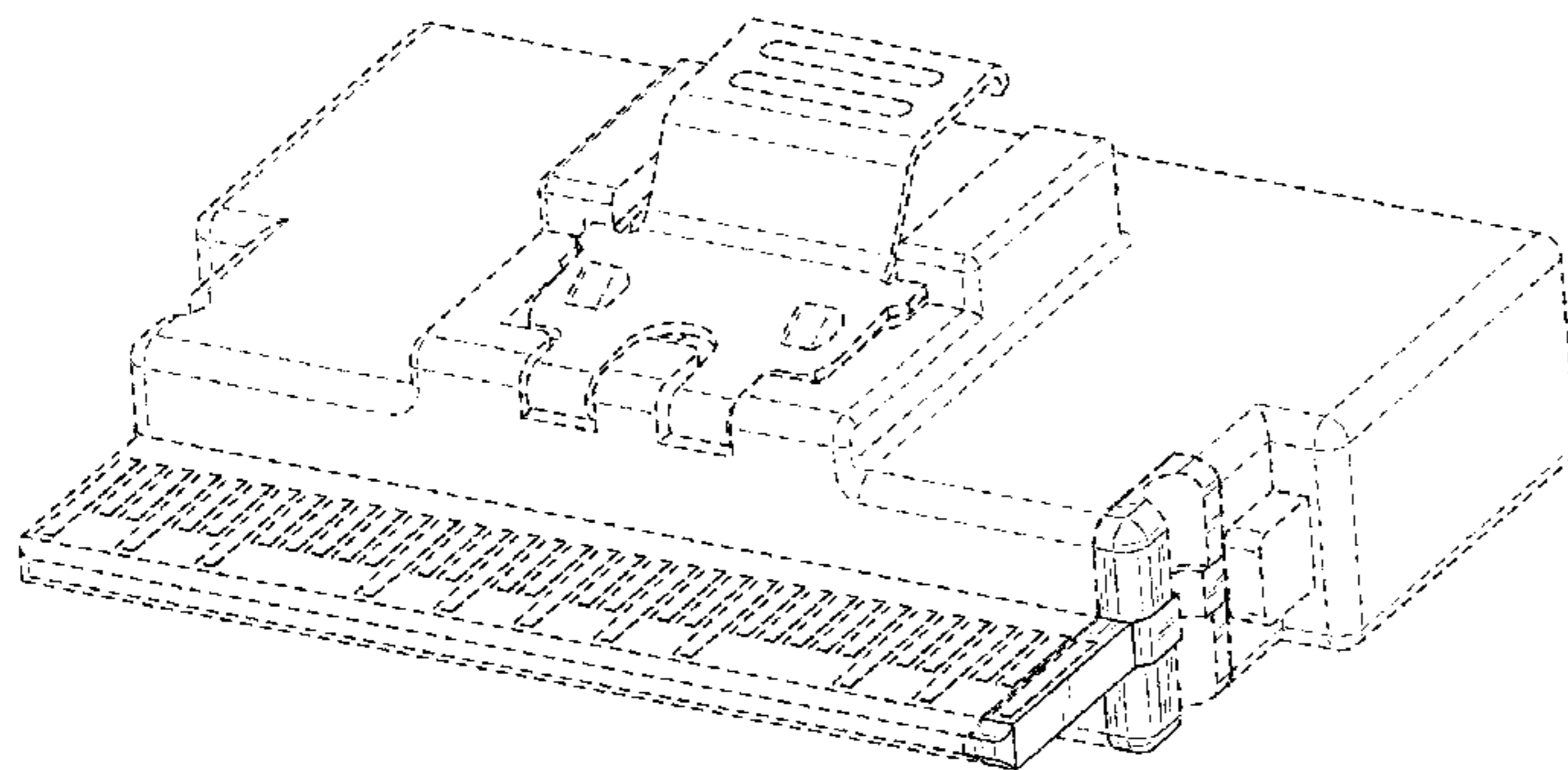

(56)

References Cited

U.S. PATENT DOCUMENTS

D726,657 S 4/2015 Takenaga et al.
D729,173 S * 5/2015 Fukumoto D13/147

* cited by examiner

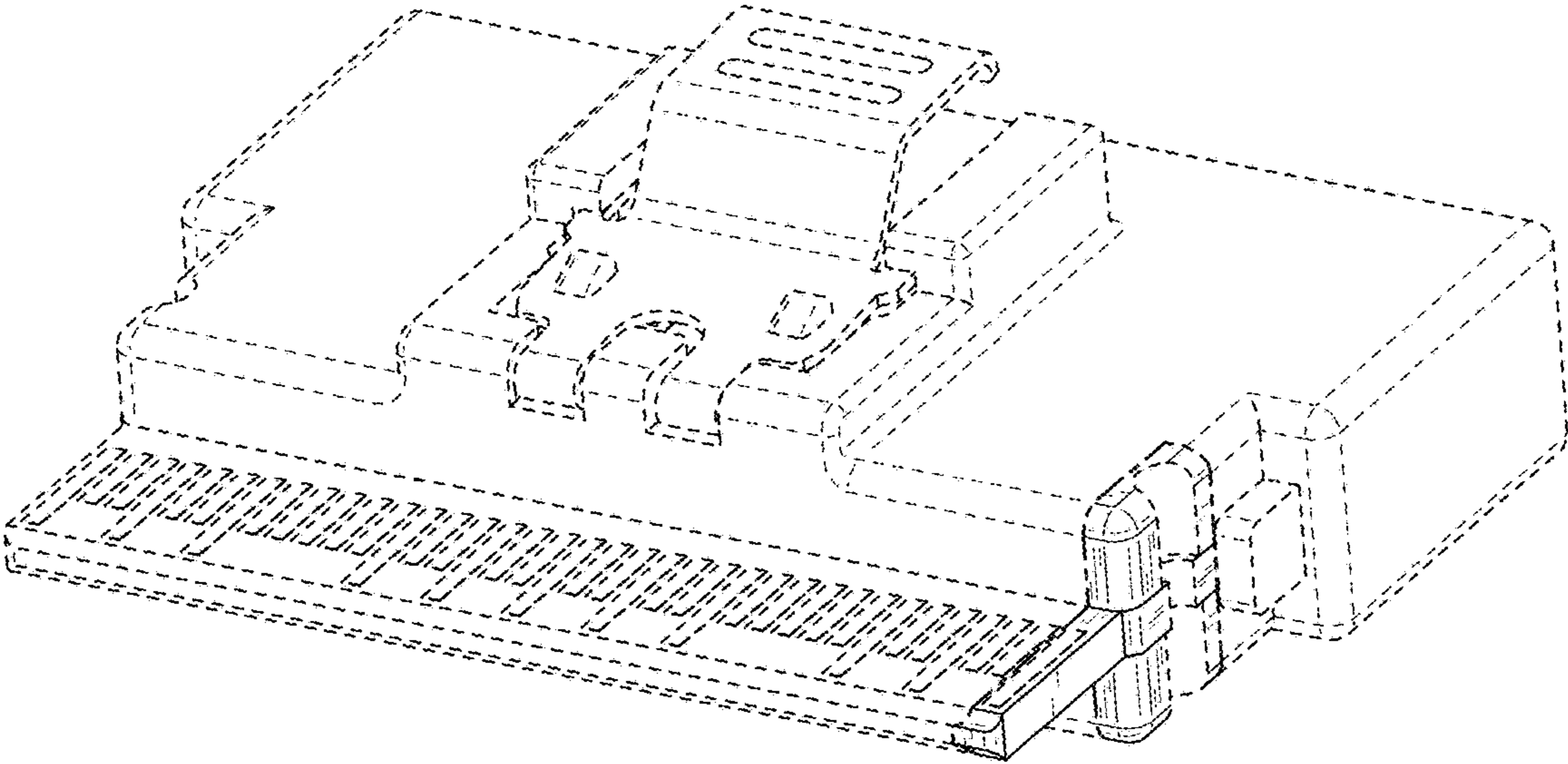

FIG. 1

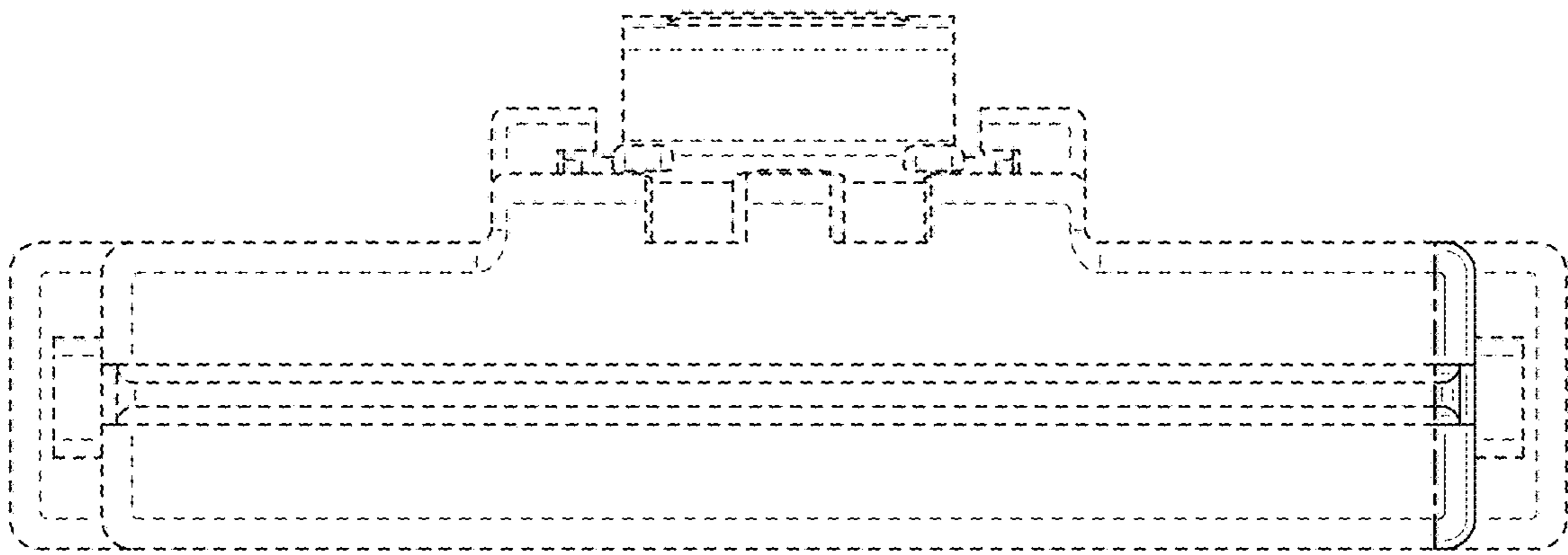

FIG. 2

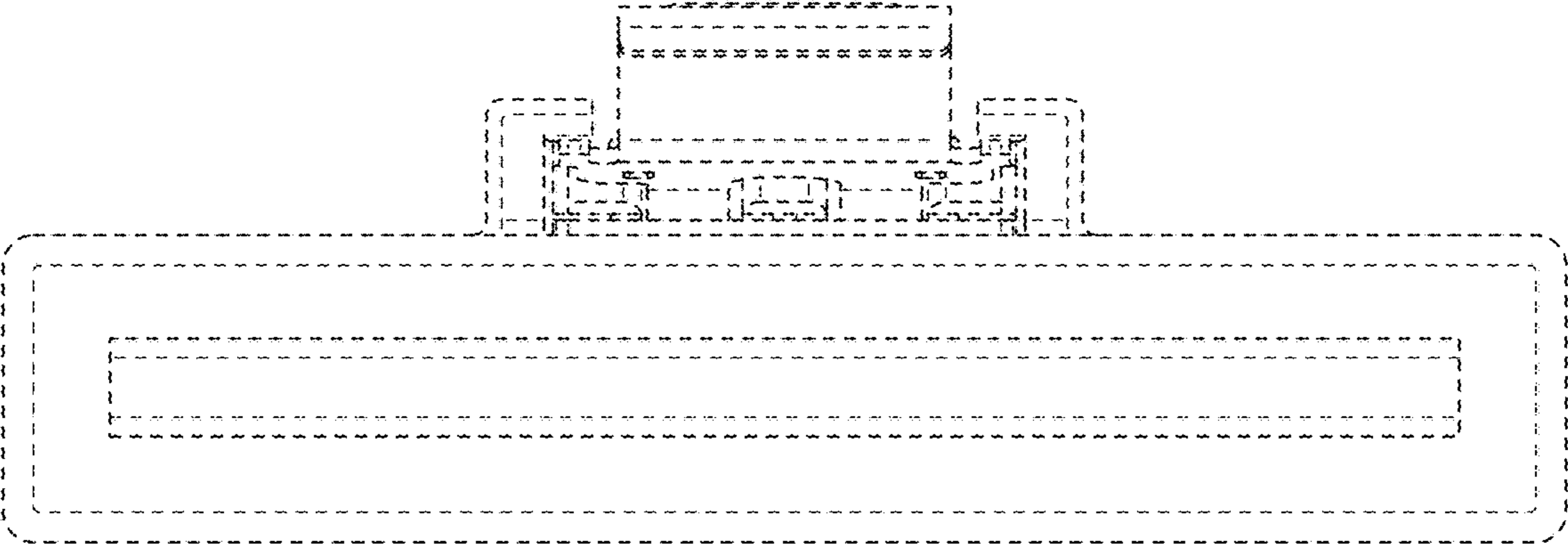

FIG. 3

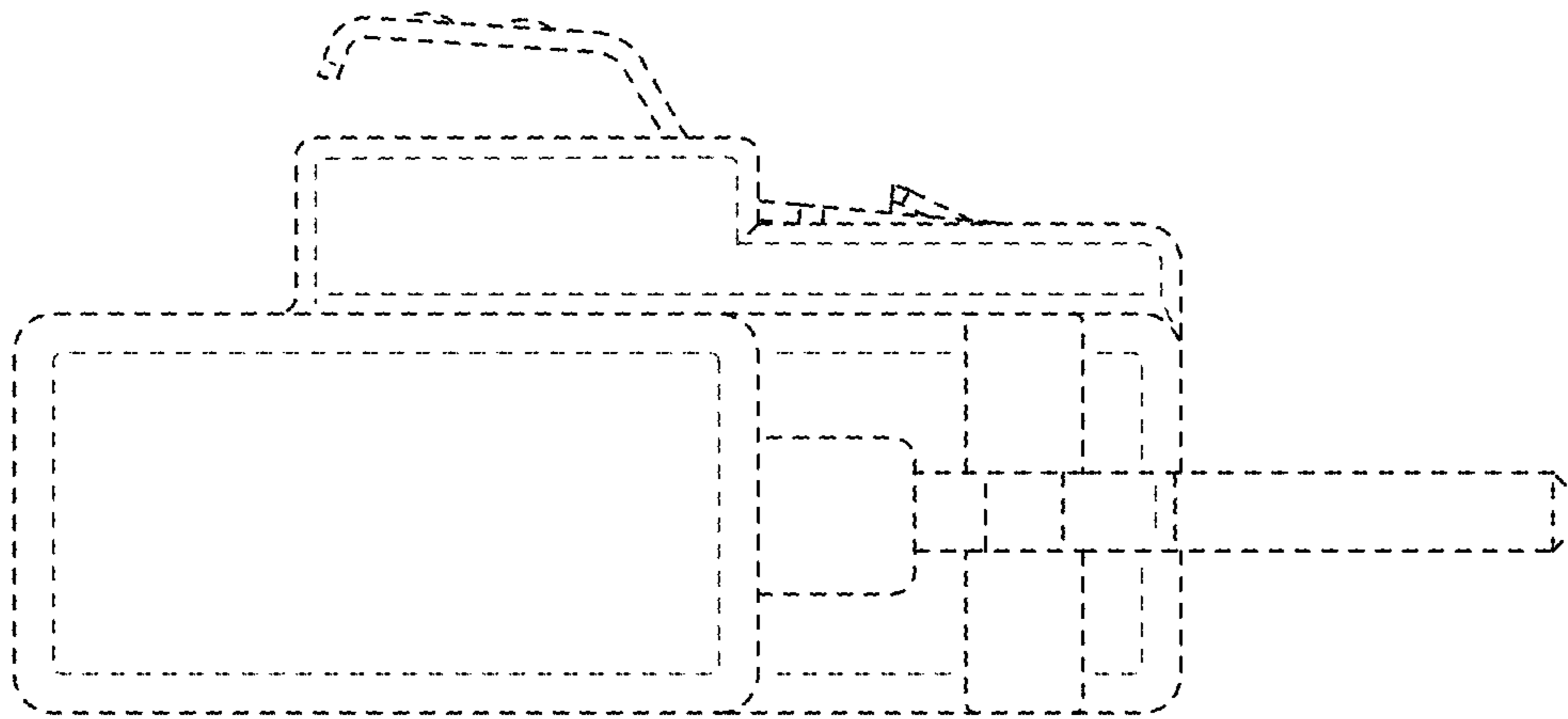

FIG. 4

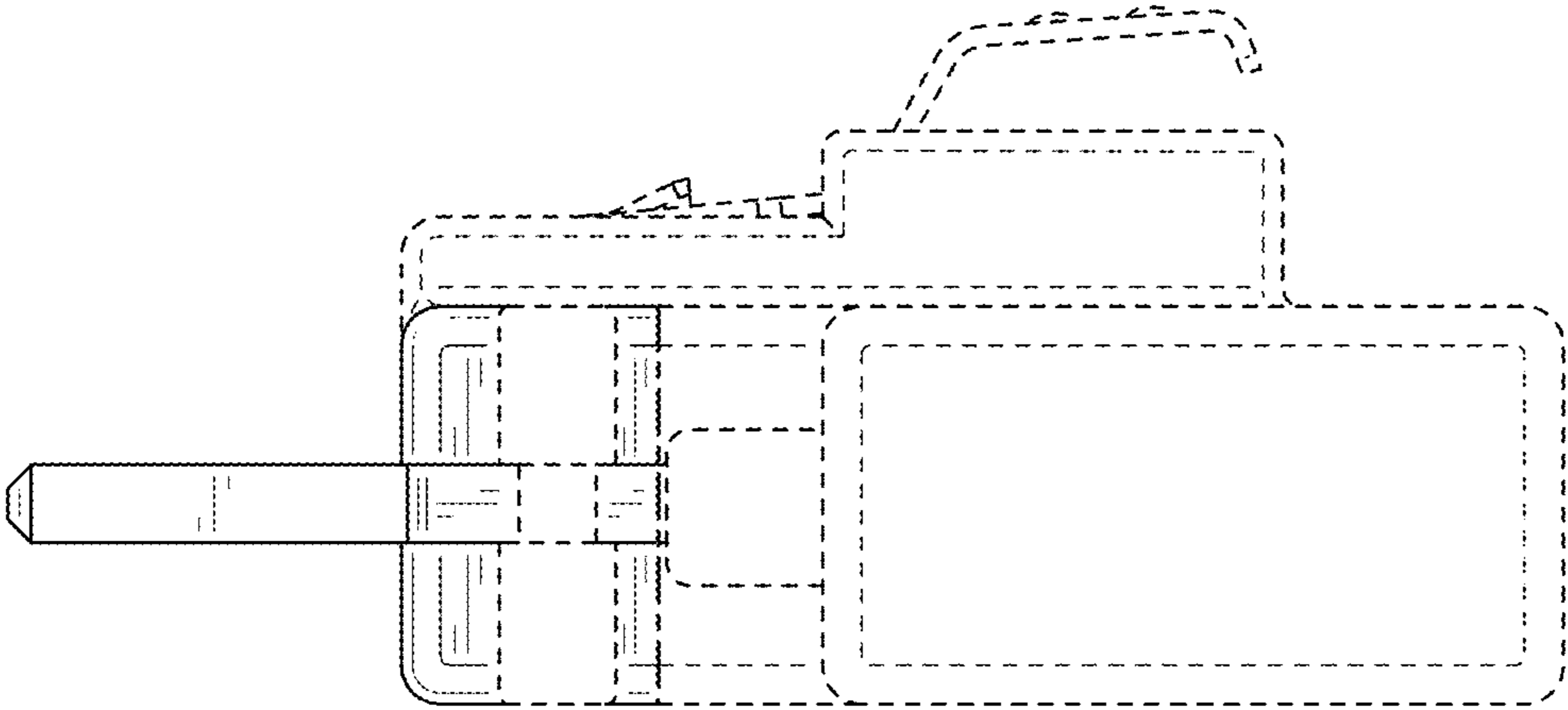

FIG. 5

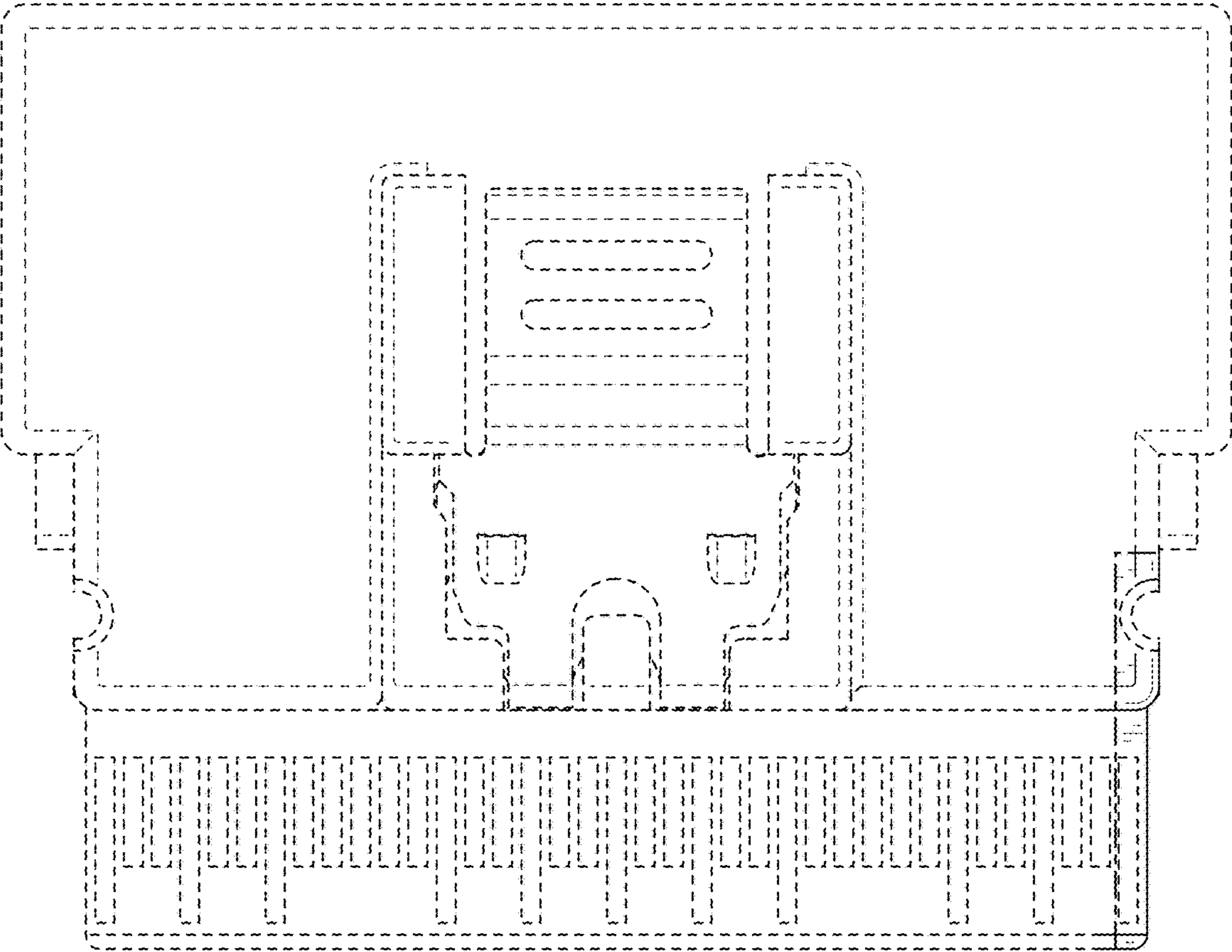

FIG. 6

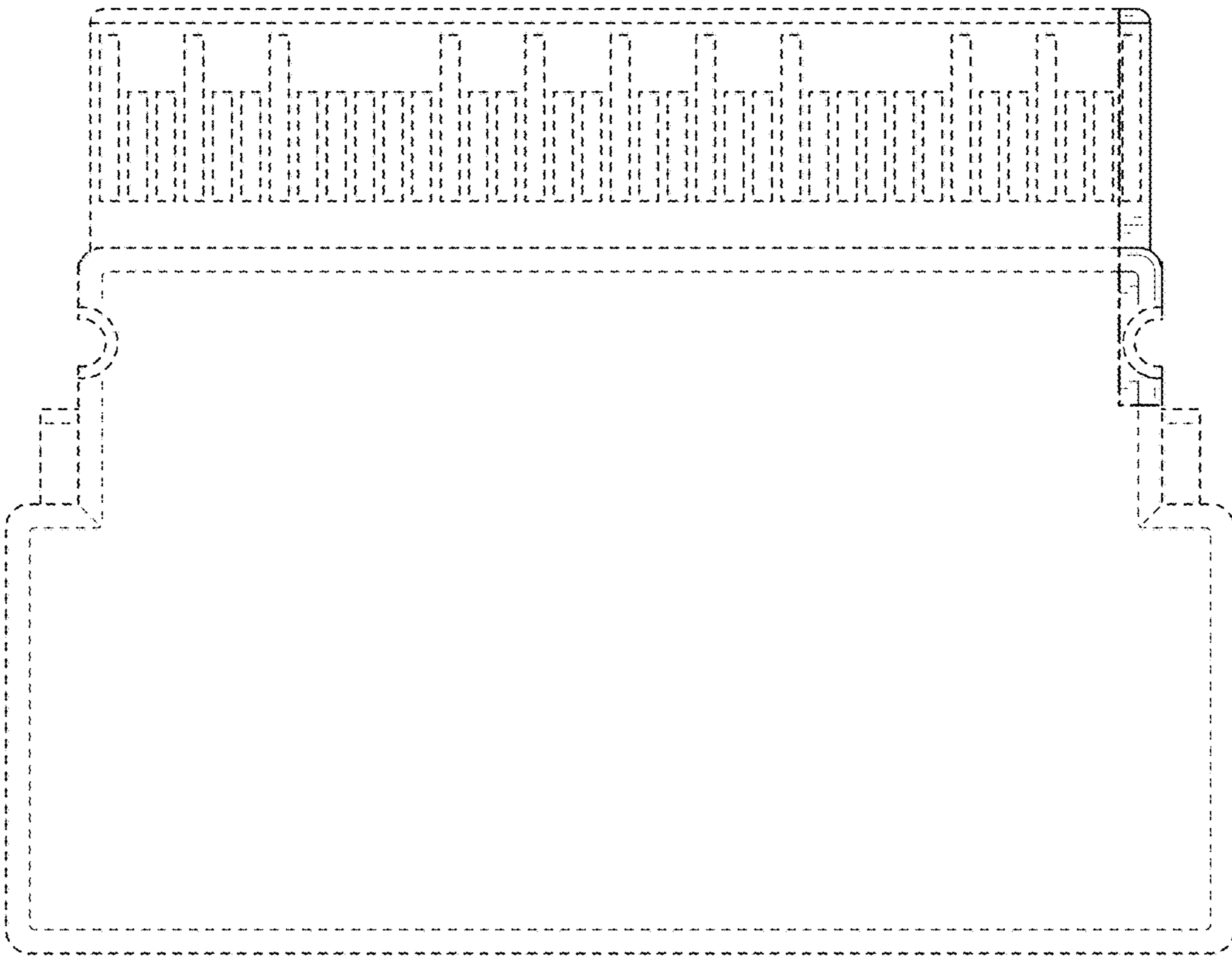

FIG. 7