



US00D813038S

(12) **United States Design Patent** (10) **Patent No.:** **US D813,038 S**  
**Fuchs et al.** (45) **Date of Patent:** **\*\* Mar. 20, 2018**

(54) **BOTTLE**  
(71) Applicant: **Nuapua GmbH**, Kremsmünster (AT)  
(72) Inventors: **Gerhard Fuchs**, Prutz/Kauns (AT);  
**Hermann Bürtlmair**, Kremsmünster (AT)  
(73) Assignee: **NUAPUA GMBH**, Kremsmünster (DE)  
(\*\*) Term: **15 Years**  
(21) Appl. No.: **29/550,311**  
(22) Filed: **Dec. 31, 2015**

(30) **Foreign Application Priority Data**  
Mar. 20, 2015 (EP) ..... 001432124-0002  
(51) **LOC (11) Cl.** ..... **09-01**  
(52) **U.S. Cl.**  
USPC ..... **D9/500**; D9/503; D9/558; D9/575  
(58) **Field of Classification Search**  
USPC ..... D7/300–322, 391–396.2, 509–511, 523,  
D7/589, 598, 612, 615, 619.1;  
(Continued)

(56) **References Cited**  
**U.S. PATENT DOCUMENTS**  
D258,202 S \* 2/1981 Astor ..... D9/503  
D434,974 S \* 12/2000 Weber ..... D9/692  
(Continued)

**OTHER PUBLICATIONS**  
“Nuapua unsweetened, natural and tasty drinking.” lilligreen.de, translated. Accessed via Internet Archive Wayback Machine. Captured Mar. 15, 2015. Accessed Apr. 26, 2017. Available online at URL: <<https://web.archive.org/web/20150315014806/http://www.lilligreen.de/nuapua-natrueerliches-geschmackvolles-trinken/>>.\*  
(Continued)

*Primary Examiner* — Cathron C Brooks  
*Assistant Examiner* — Christian P. McLean  
(74) *Attorney, Agent, or Firm* — Henry M. Feiereisen LLC

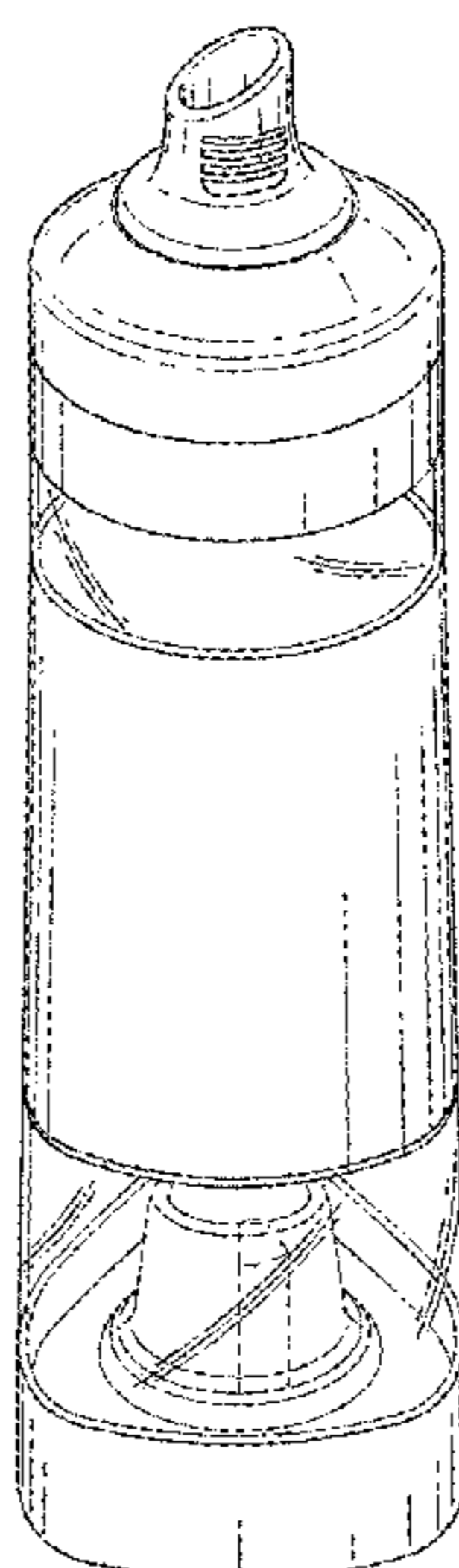
(57) **CLAIM**

The ornamental design for a bottle, as shown and described.

**DESCRIPTION**

FIG. 1 is a top-front-left side perspective view of a bottle, showing our new design;  
FIG. 2 is a bottom front perspective view thereof;  
FIG. 3 is a front view thereof;  
FIG. 4 is a rear view thereof;  
FIG. 5 is a left view thereof;  
FIG. 6 is a right view thereof;  
FIG. 7 is a top view thereof;  
FIG. 8 is a bottom view thereof;  
FIG. 9 is a top-front-left side perspective exploded view thereof;  
FIG. 10 is a bottom front perspective exploded view thereof;  
FIG. 11 is a front view thereof;  
FIG. 12 is a rear view thereof;  
FIG. 13 is a left view thereof;  
FIG. 14 is a right view thereof;  
FIG. 15 is a top-front-left side perspective view of another embodiment of the bottle;  
FIG. 16 is a bottom front perspective view thereof;  
FIG. 17 is a front view thereof;  
FIG. 18 is a rear view thereof;  
FIG. 19 is a left view thereof;  
FIG. 20 is a right view thereof;  
FIG. 21 is a top view thereof; and,  
FIG. 22 is a bottom view thereof.  
The broken line showing of portions of the bottle forms no part of the claimed design.

**1 Claim, 11 Drawing Sheets**



(58) **Field of Classification Search**

USPC ..... D9/500–575; 215/40–55, 316–354,  
215/370–385; 220/574–575  
CPC . B05B 11/0089; B29D 23/20; B29L 2023/20;  
B65D 1/00; B65D 1/02; B65D 1/0223;  
B65D 1/023; B65D 1/0276; B65D  
47/0857; B65D 81/3288; F04B 9/14  
See application file for complete search history.

D747,928 S \* 1/2016 Herbst ..... D7/510  
D749,949 S \* 2/2016 Bruining ..... D9/447  
D758,800 S \* 6/2016 Hayslett ..... D7/300.1  
D763,086 S \* 8/2016 Kalagher ..... D9/504  
D764,870 S \* 8/2016 Choi ..... D7/507  
D767,339 S \* 9/2016 Chitayat ..... D7/399  
D777,575 S \* 1/2017 Harada ..... D9/500  
2015/0291312 A1 \* 10/2015 Kalagher ..... B65D 81/3227  
215/6

(56)

**References Cited**

U.S. PATENT DOCUMENTS

D453,472 S \* 2/2002 Kwong ..... D9/447  
D498,979 S \* 11/2004 Bhavnani ..... D7/510  
D499,342 S \* 12/2004 Klitsner ..... D7/300.1  
7,455,191 B2 \* 11/2008 Bhavnani ..... A47J 41/0016  
220/254.9  
D582,767 S \* 12/2008 Batton ..... D9/447  
D585,599 S \* 1/2009 Mongeon ..... D28/76  
D608,141 S \* 1/2010 Sanders ..... D7/300.1  
D675,481 S \* 2/2013 Enghard ..... D7/510  
D698,244 S \* 1/2014 Lin ..... D9/500  
D721,914 S \* 2/2015 Hakim ..... D7/396.2  
D731,244 S \* 6/2015 Kohl ..... D7/510  
D735,514 S \* 8/2015 Cheung ..... D7/300  
D742,174 S \* 11/2015 Roth ..... D7/300.2

OTHER PUBLICATIONS

“The Fancier—Gerhard Fuchs invented Nuapua: a bottle that gives water flavor.” kurier.at, translated. Posted Jan. 28, 2015. Accessed Apr. 26, 2017. Available online at URL: <<https://kurier.at/wirtschaft/karriere/der-geschmackstraeger/110.692.025>>.\*

“Nuapua. Revolutionizing the Way We Consume Water.” YouTube.com. 01:59. Published Jan. 9, 2015. Accessed Apr. 26, 2017. Available online at URL: <<https://www.youtube.com/watch?v=clw8Qlv-pS8>>.\*

“1<sup>2</sup>/<sub>3</sub> Oz (50 MI) Empty Refillable Glass Perfume Bottle Atomizer Gold Lid.” Amazon.com. Reviewed Sep. 6, 2011. Accessed May 1, 2017. Available online at URL: <<https://www.amazon.com/Empty-Refillable-Perfume-Bottle-Atomizer/dp/B0044PH69A>>.\*

\* cited by examiner

FIG. 1

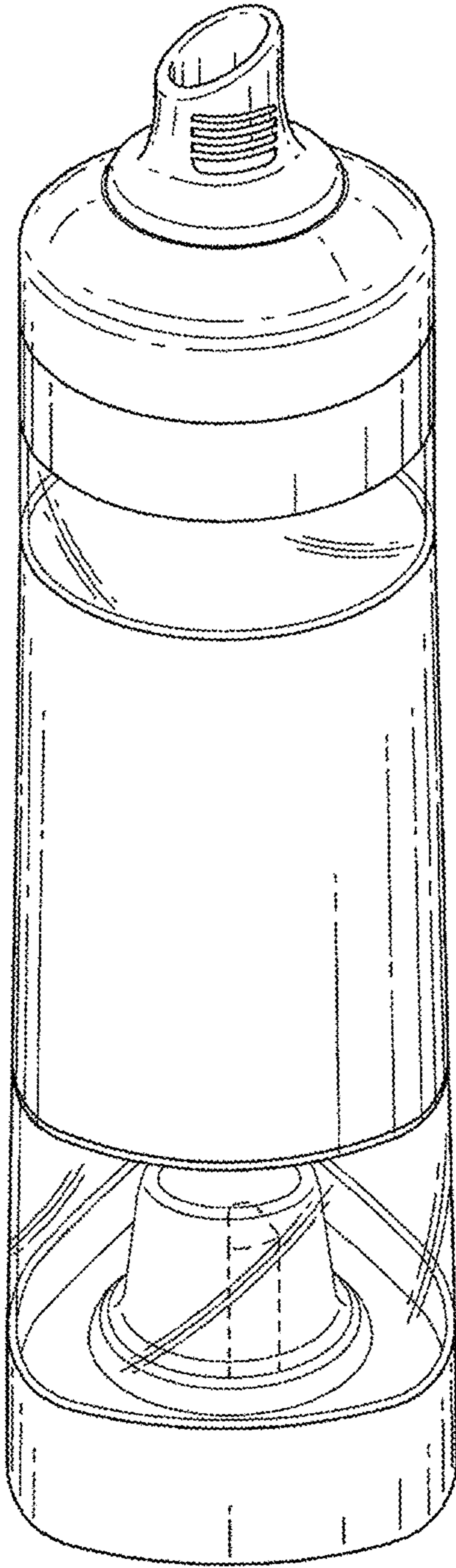


FIG. 2

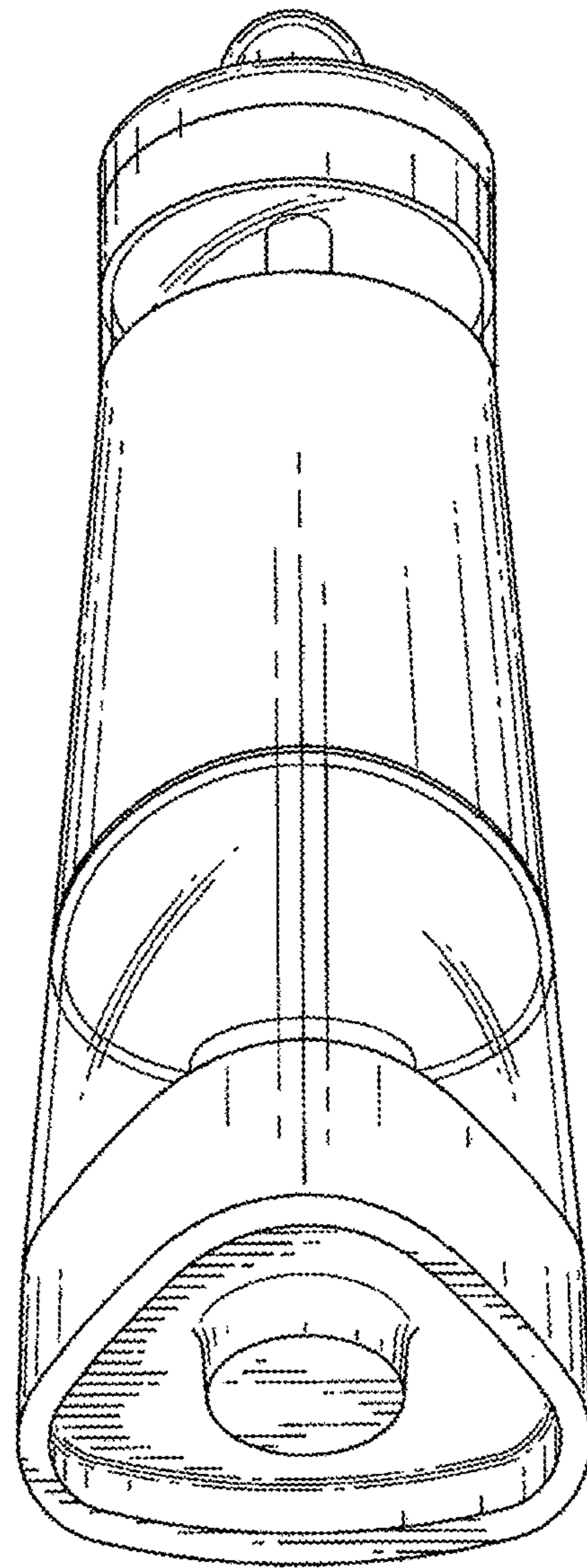




FIG. 3

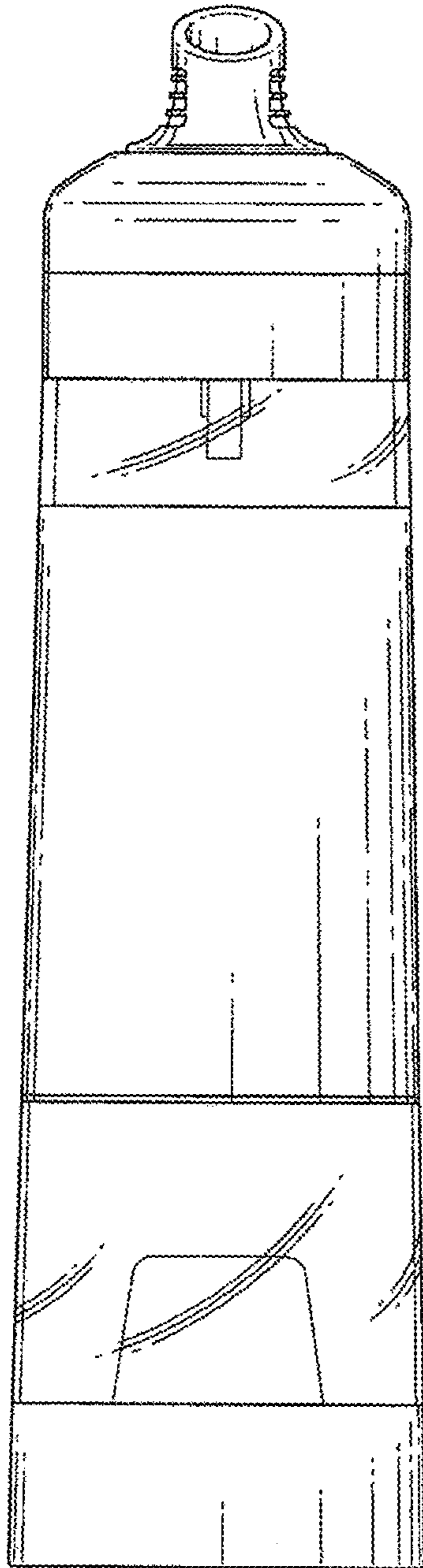


FIG. 4

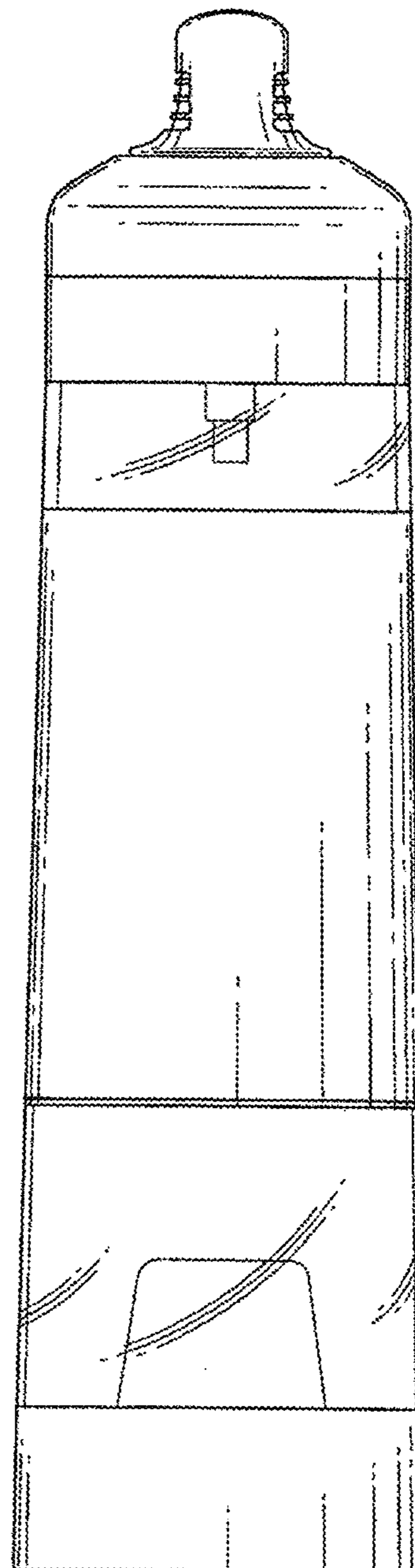


FIG. 5

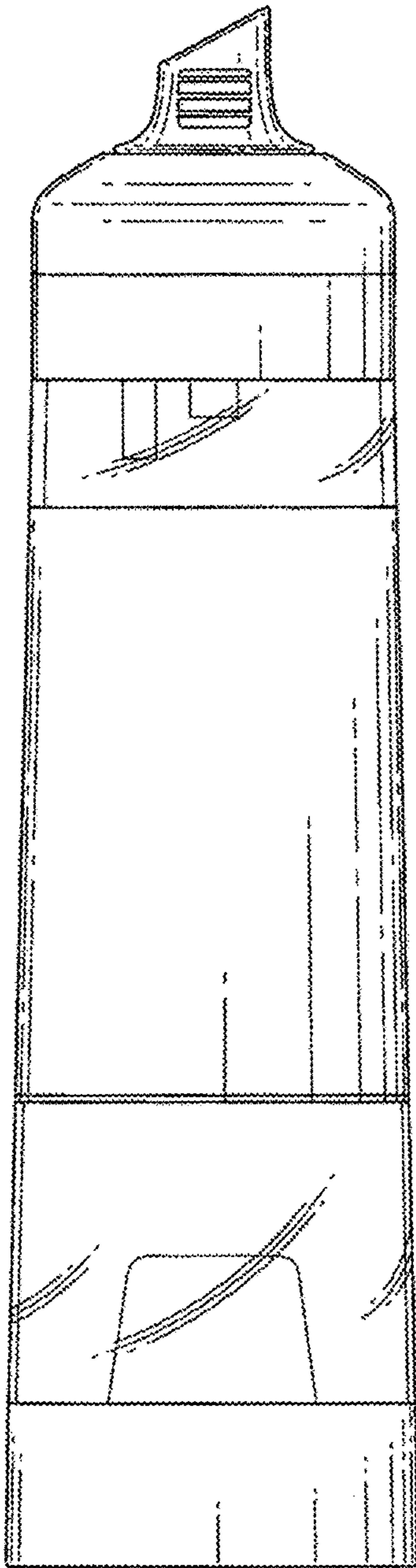


FIG. 6

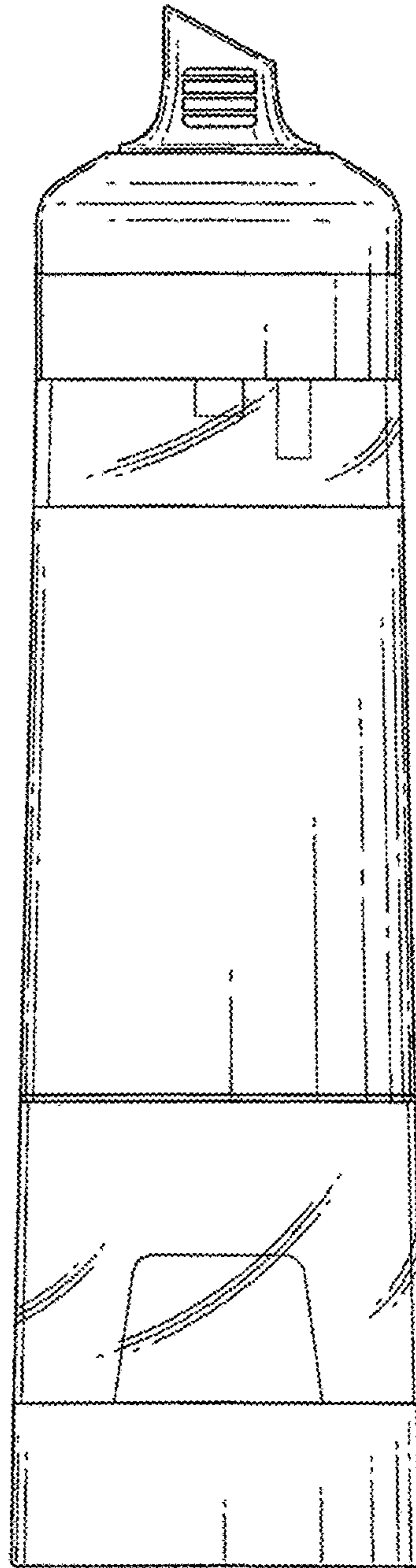


FIG. 7

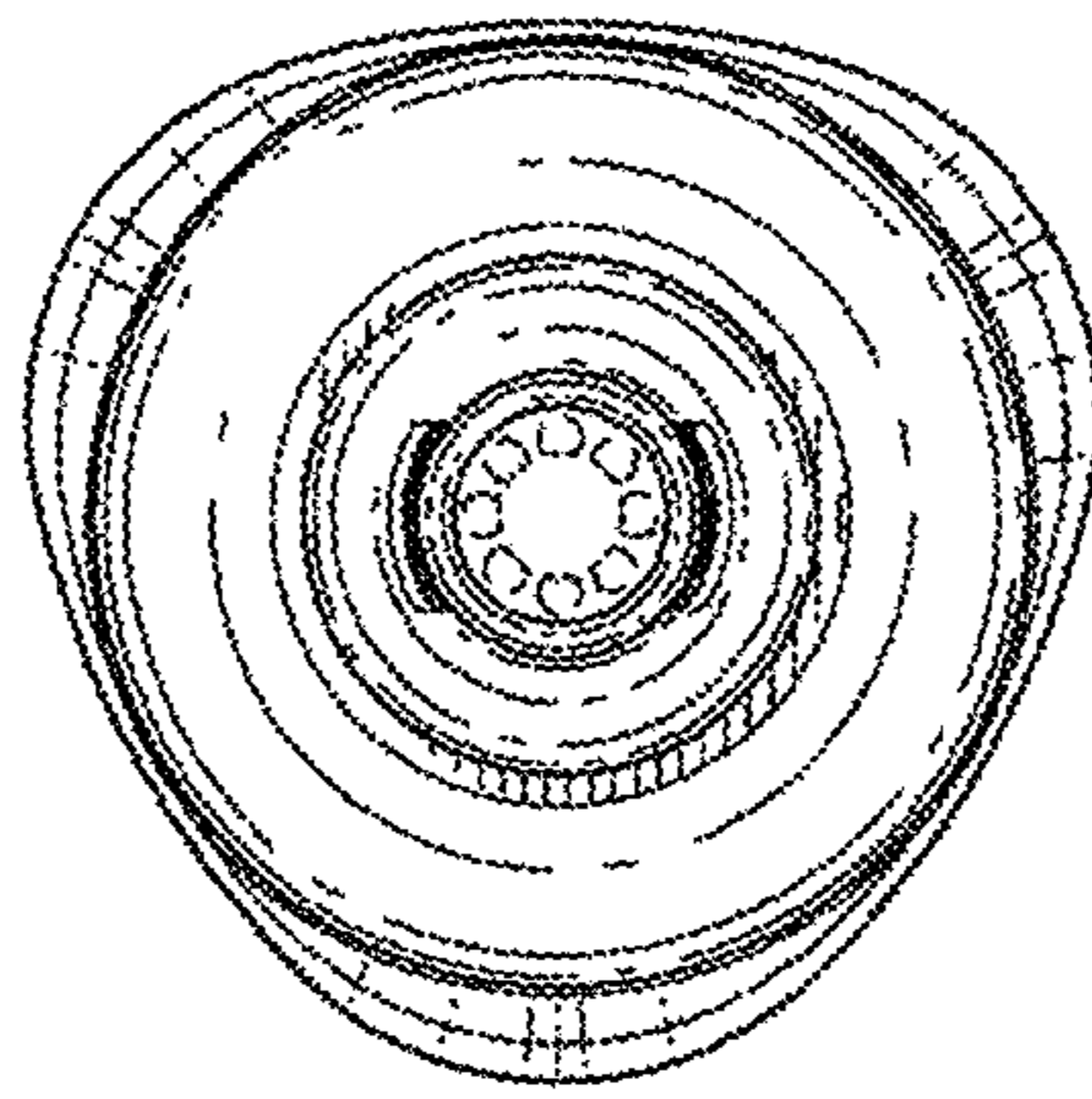


FIG. 8

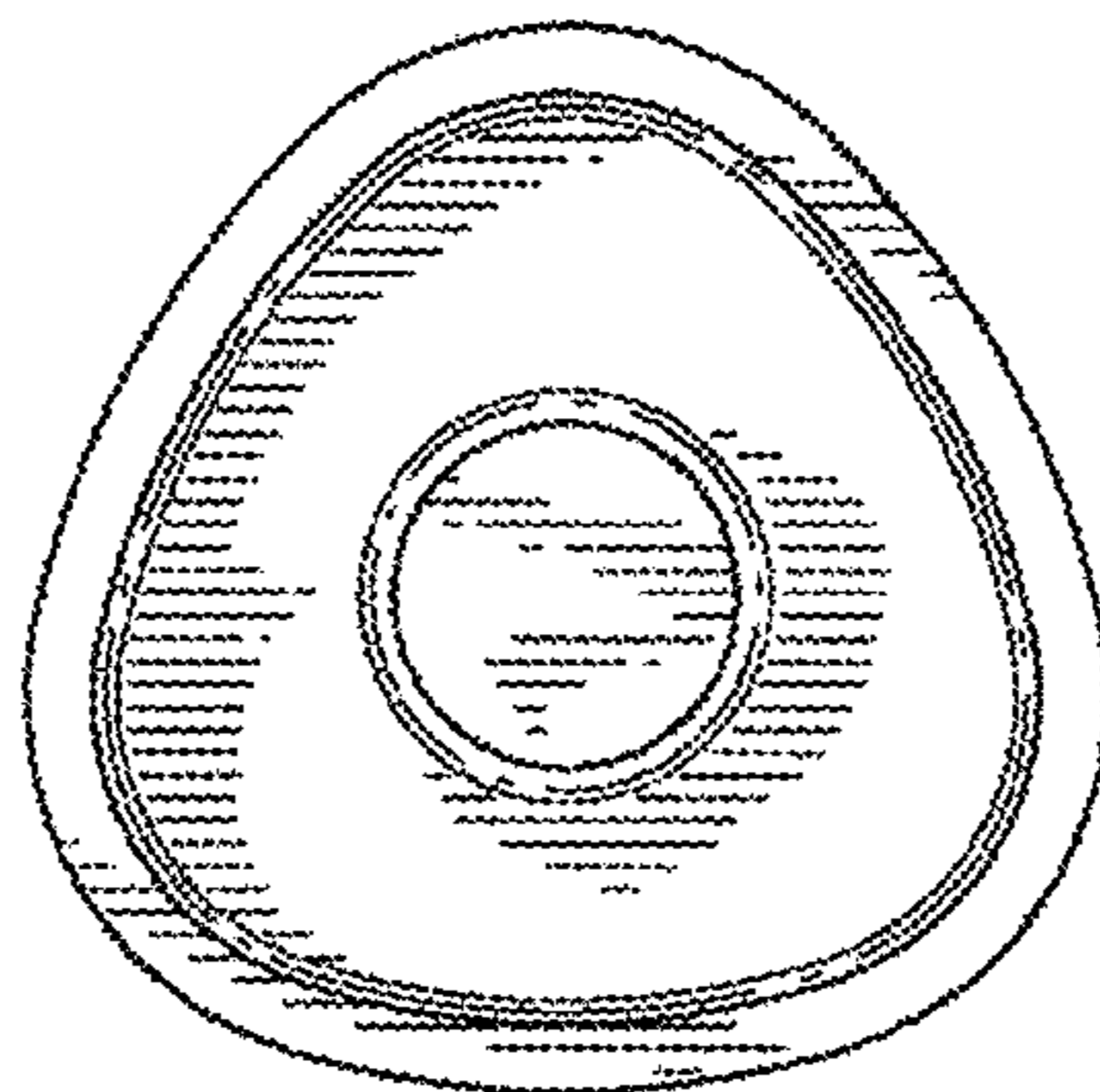




FIG. 9

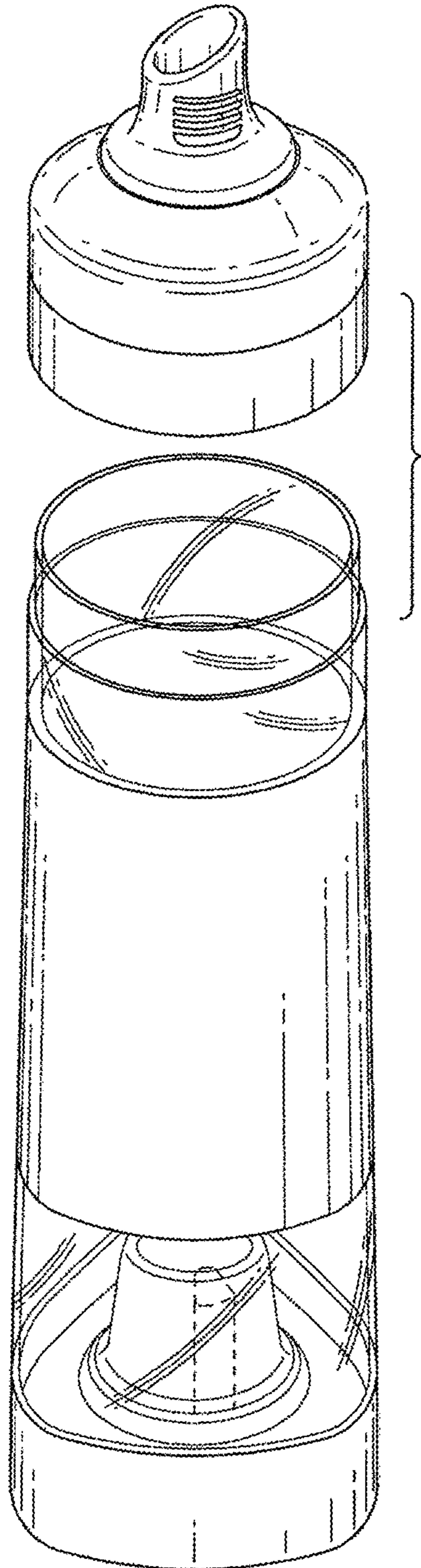


FIG. 10

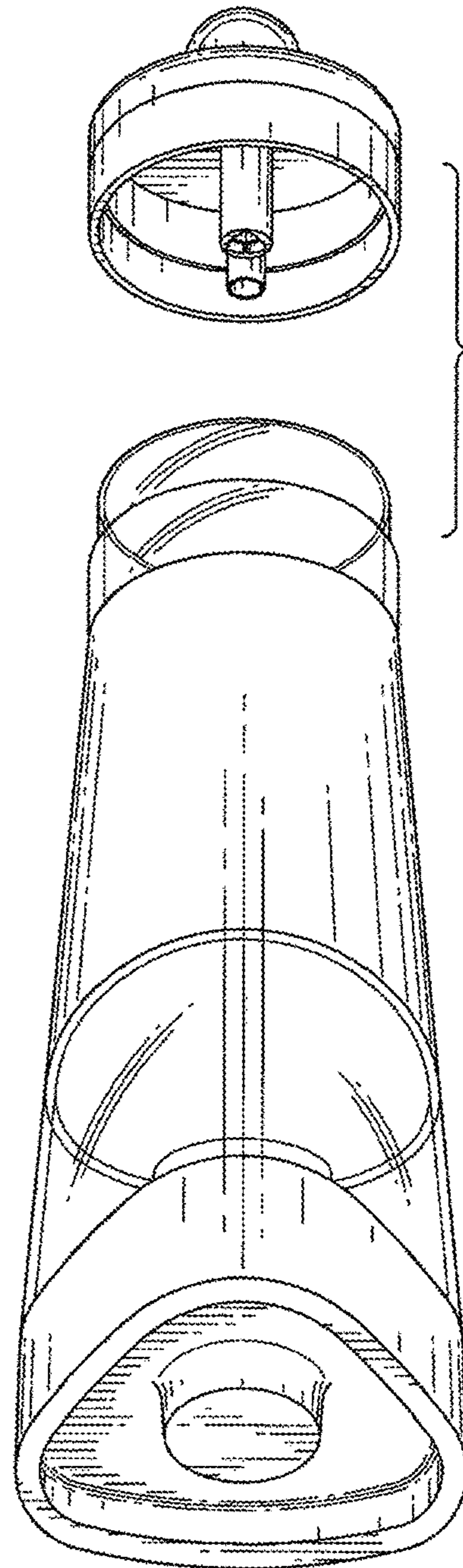


FIG. 11

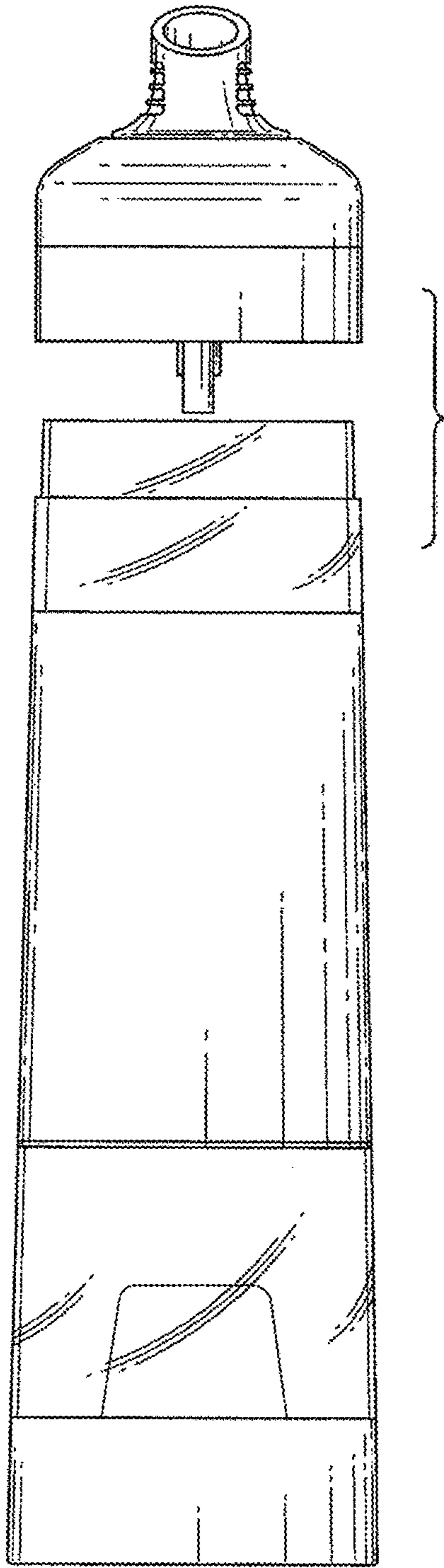


FIG. 12

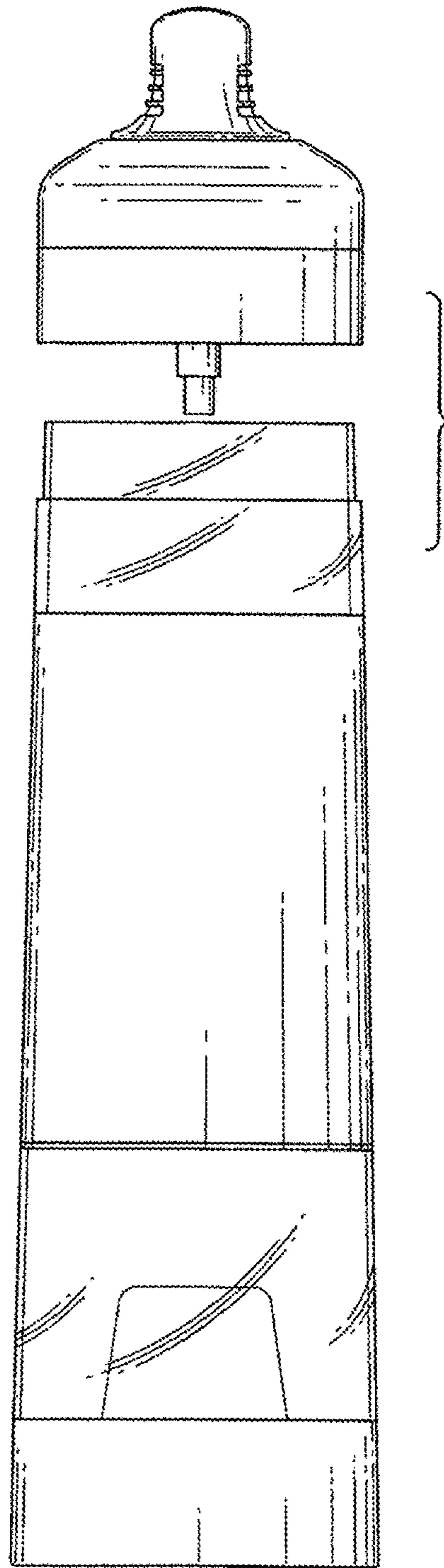




FIG. 13

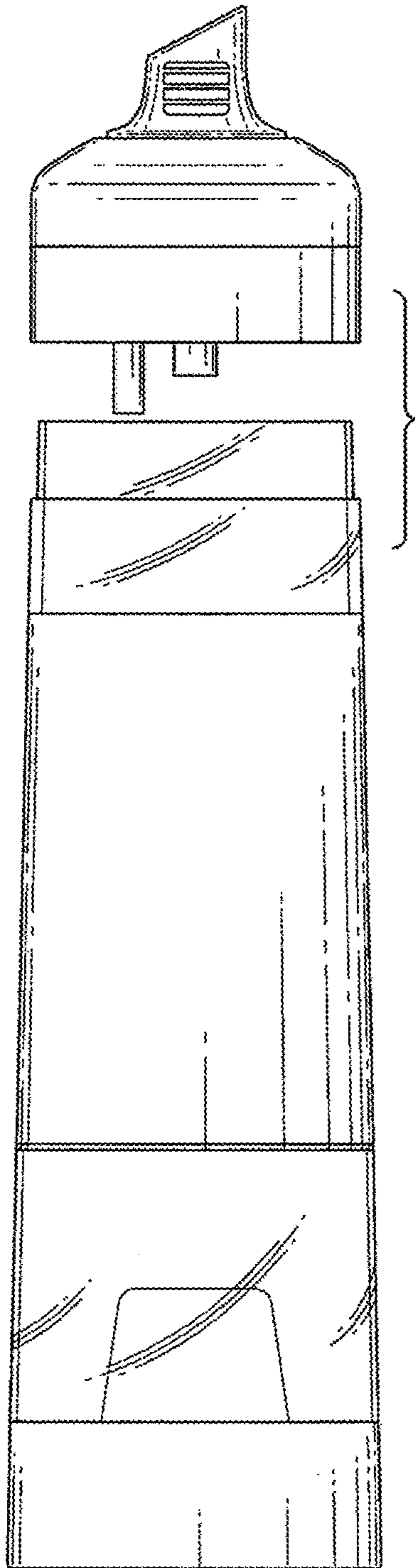
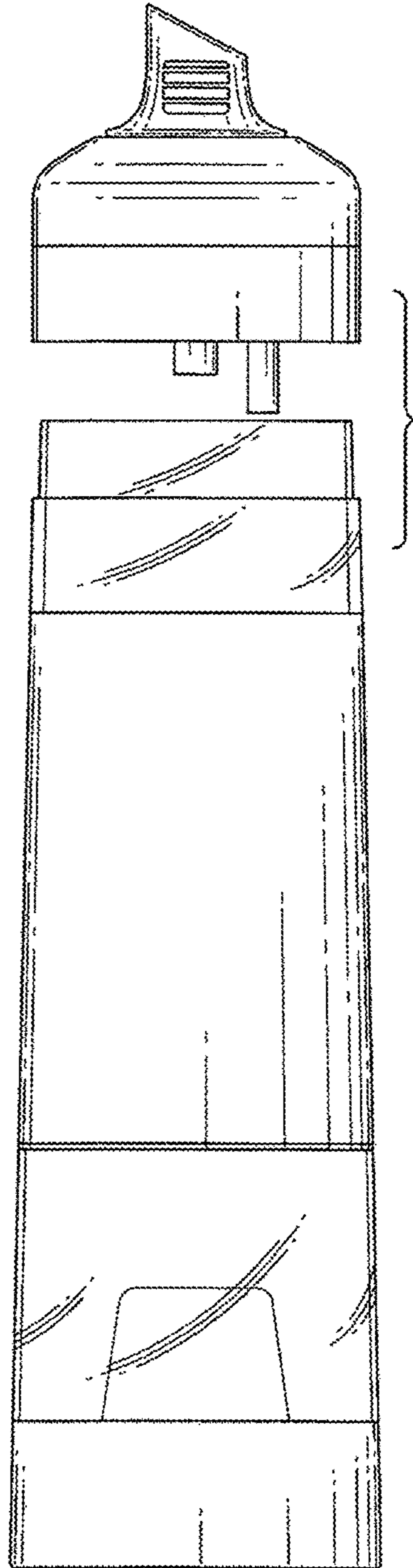
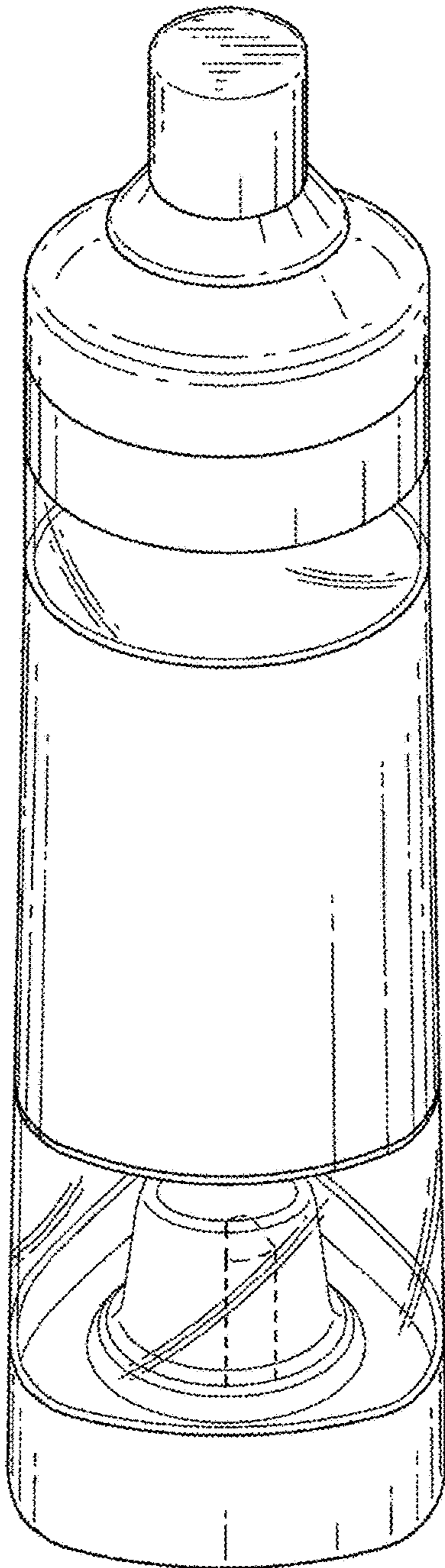


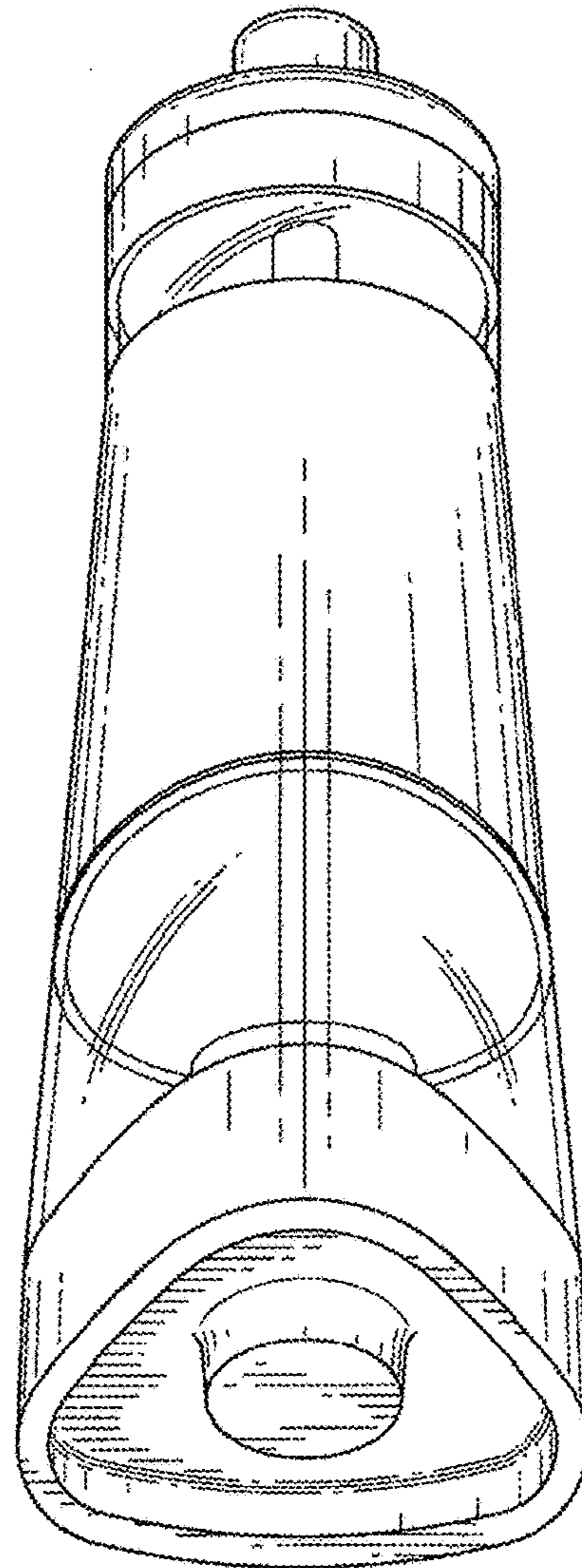
FIG. 14



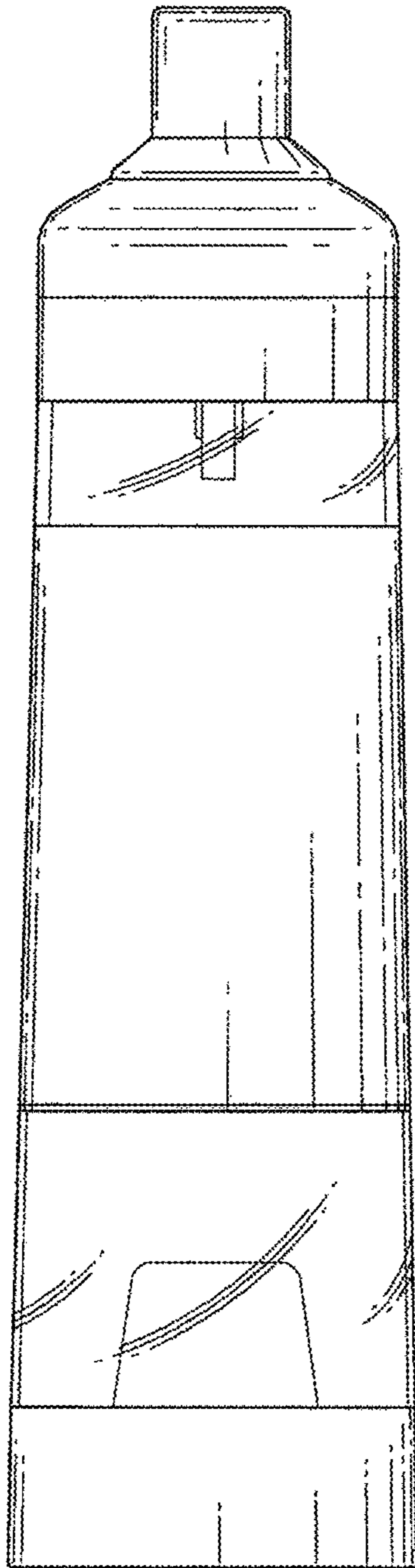
**FIG. 15**



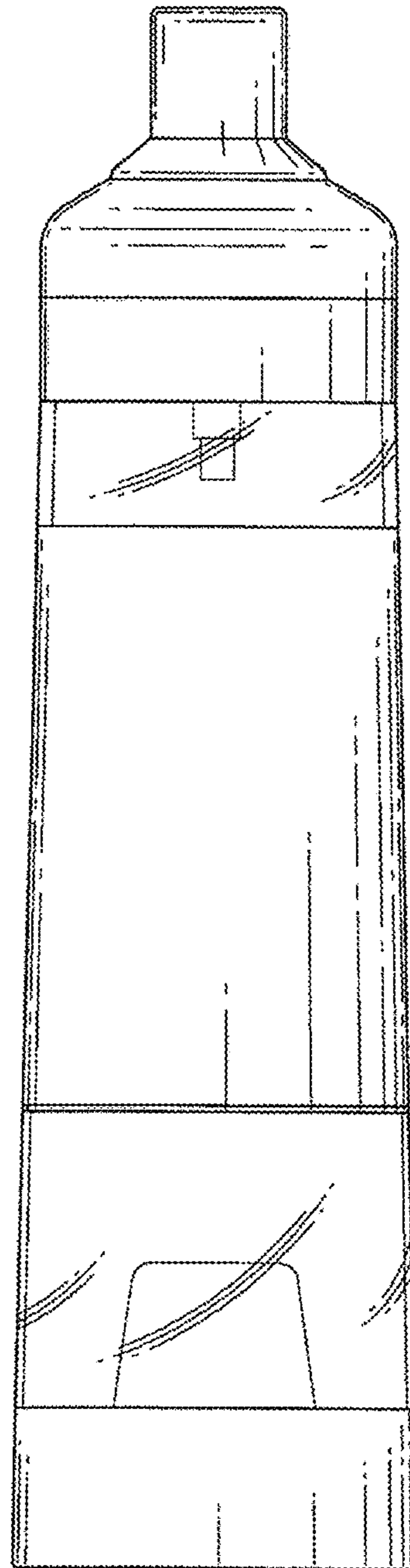
**FIG. 16**



**FIG. 17**

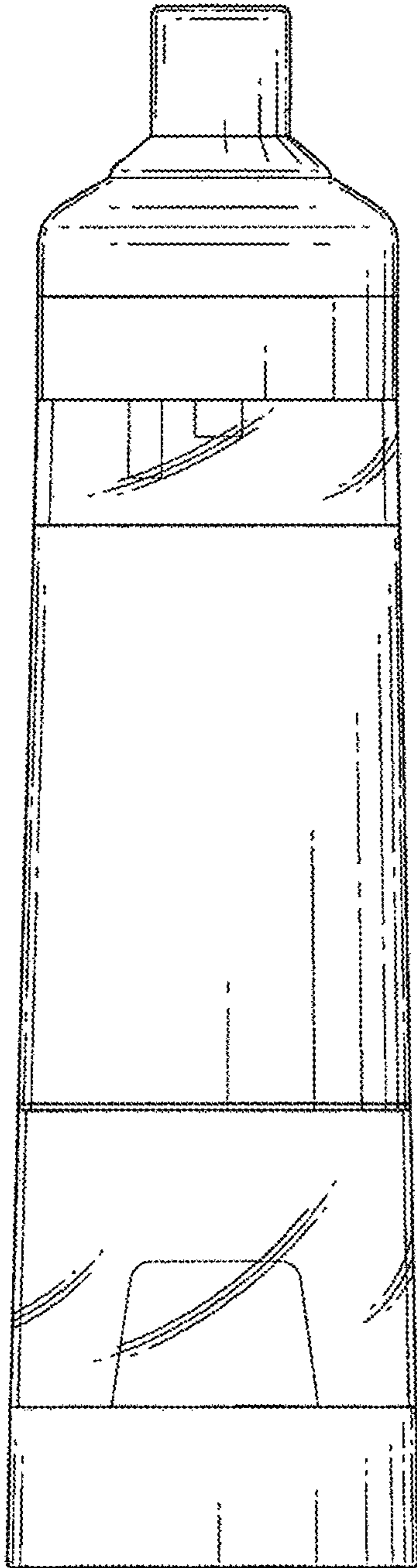


**FIG. 18**





**FIG. 19**



**FIG. 20**

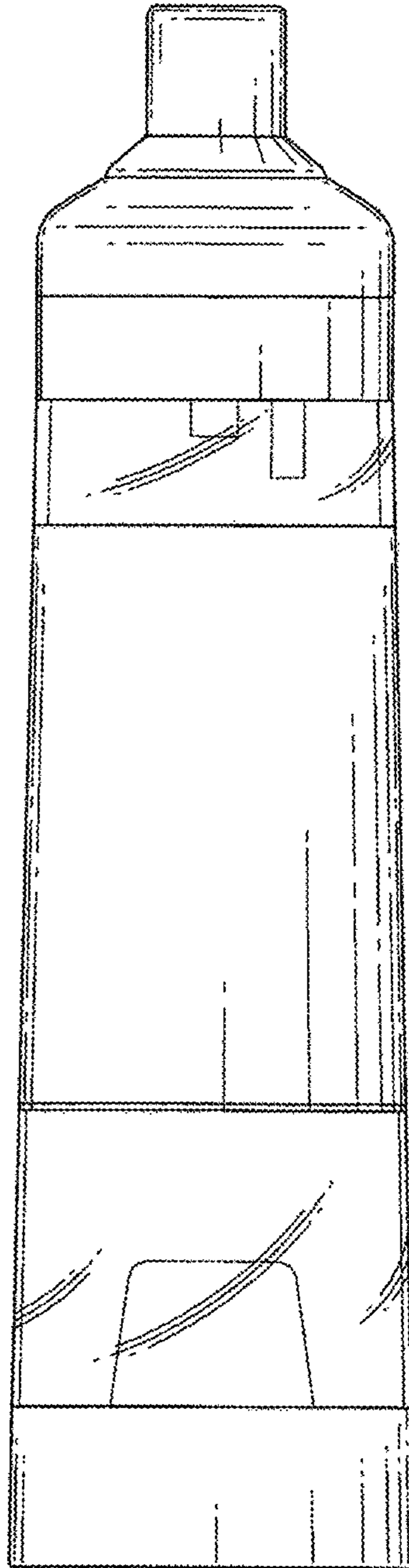


FIG. 21

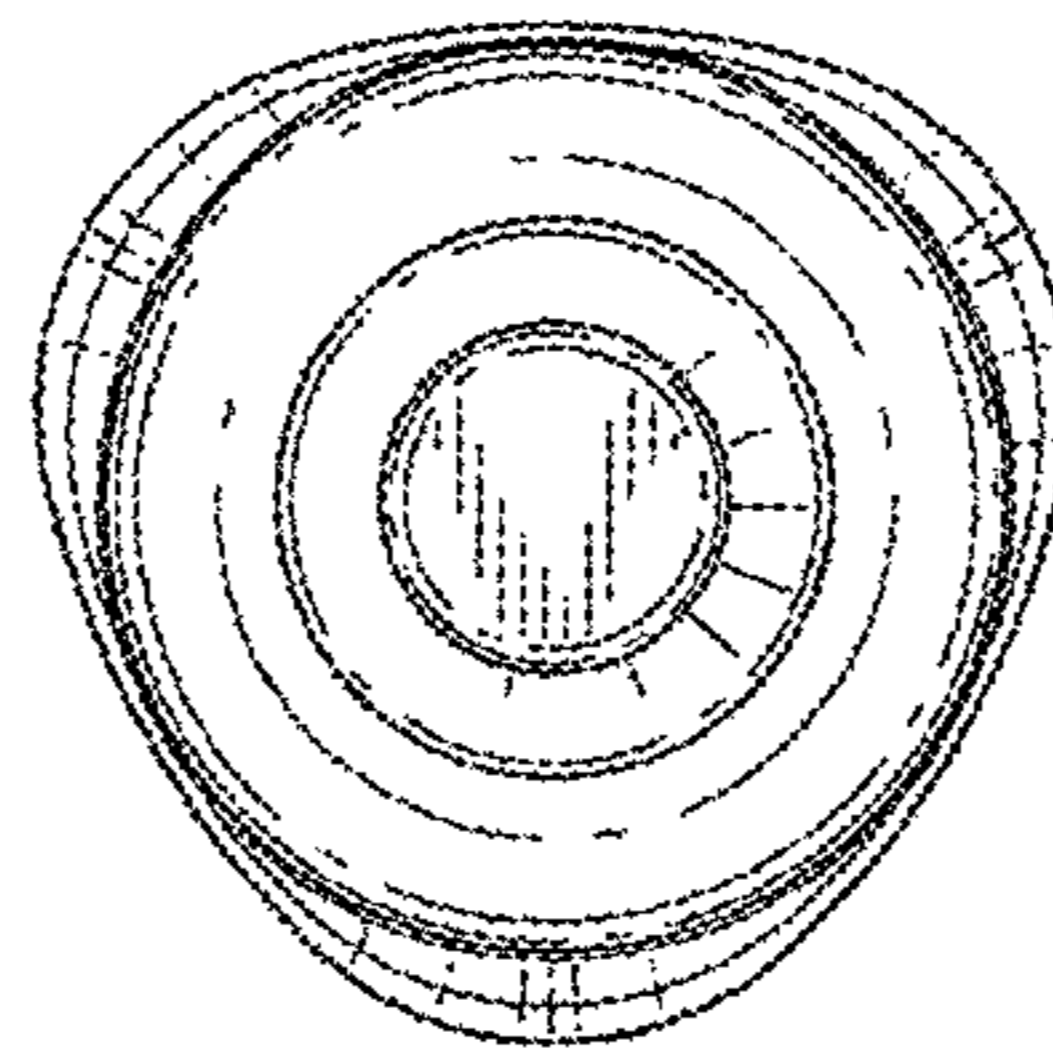


FIG. 22

