



US00D812933S

(12) **United States Design Patent** (10) **Patent No.:** **US D812,933 S**  
**Leonorovitz** (45) **Date of Patent:** **\*\* Mar. 20, 2018**

(54) **LID FOR JEWELRY BOX**  
(71) Applicant: **GLENOR INC**, Brooklyn, NY (US)  
(72) Inventor: **Goldy Leonorovitz**, Brooklyn, NY (US)  
(73) Assignee: **Glenor Inc.**, Brooklyn, NY (US)  
(\*\*) Term: **15 Years**

(21) Appl. No.: **29/581,099**  
(22) Filed: **Oct. 17, 2016**  
(51) **LOC (11) Cl.** ..... **06-04**  
(52) **U.S. Cl.**  
USPC ..... **D6/667**  
(58) **Field of Classification Search**  
USPC ..... D6/384, 515, 663, 667, 671, 671.1,  
D6/675.1; D3/269, 296, 304, 307, 309;  
D7/333, 368; D23/286, 343, 342;  
D24/227-230; D25/48.4, 113, 163  
CPC . A47F 3/043; A47F 7/03; A47F 7/021; A47B  
49/004; A47B 88/90; A47B 2095/024;  
F25D 23/026  
See application file for complete search history.

(56) **References Cited**  
**U.S. PATENT DOCUMENTS**  
310,088 A \* 12/1884 Sherry ..... E04L 32/14  
52/270  
D21,631 S \* 6/1892 Crossley ..... D25/113  
2,793,925 A \* 5/1957 Rosen ..... A47F 3/043  
312/139.2

(Continued)

**OTHER PUBLICATIONS**  
"Sale Black Watch Display Case Large Watch Box Glass Top Ebony Black Jewelry Box with Removable Tray Adjustable Pillows Holds 10 plus Watches." Jul. 19, 2013, etsy.com, site visited Oct. 10, 2017 (Year: 2013).\*

(Continued)

*Primary Examiner* — Kevin K Rudzinski  
*Assistant Examiner* — Paul D Bohannon  
(74) *Attorney, Agent, or Firm* — Baker and Rannells, PA

(57) **CLAIM**

The ornamental design for a lid for jewelry box, as shown and described.

**DESCRIPTION**

FIG. 1 is a perspective view of a first embodiment of a lid for jewelry box in accordance with the new design, whereby the lid is in a closed position;  
FIG. 2 is a front elevational view thereof;  
FIG. 3 is a rear elevational view thereof;  
FIG. 4 is a right side elevational view thereof, whereby, the opposite left side is a mirror image thereof;  
FIG. 5 is a top plan view thereof;  
FIG. 6 is a bottom view thereof;  
FIG. 7 is a perspective view of the first embodiment of a lid for jewelry box in accordance with the new design, whereby the lid is in an open position;  
FIG. 8 is a top plan view thereof;  
FIG. 9 is a perspective view of a second embodiment of a lid for jewelry box in accordance with the new design, whereby the lid is in a closed position;  
FIG. 10 is a front elevational view thereof;  
FIG. 11 is a rear elevational view thereof;  
FIG. 12 is a right side elevational view thereof, whereby, the opposite left side is a mirror image thereof;  
FIG. 13 is a top plan view thereof;  
FIG. 14 is a bottom view thereof;  
FIG. 15 is a perspective view of the second embodiment of a lid for jewelry box in accordance with the new design, whereby the lid is in an open position; and,  
FIG. 16 is a top plan view thereof.  
The broken line showing of a jewelry box is for the purpose of illustrating environmental structure and forms no part of the claimed design.

**1 Claim, 16 Drawing Sheets**

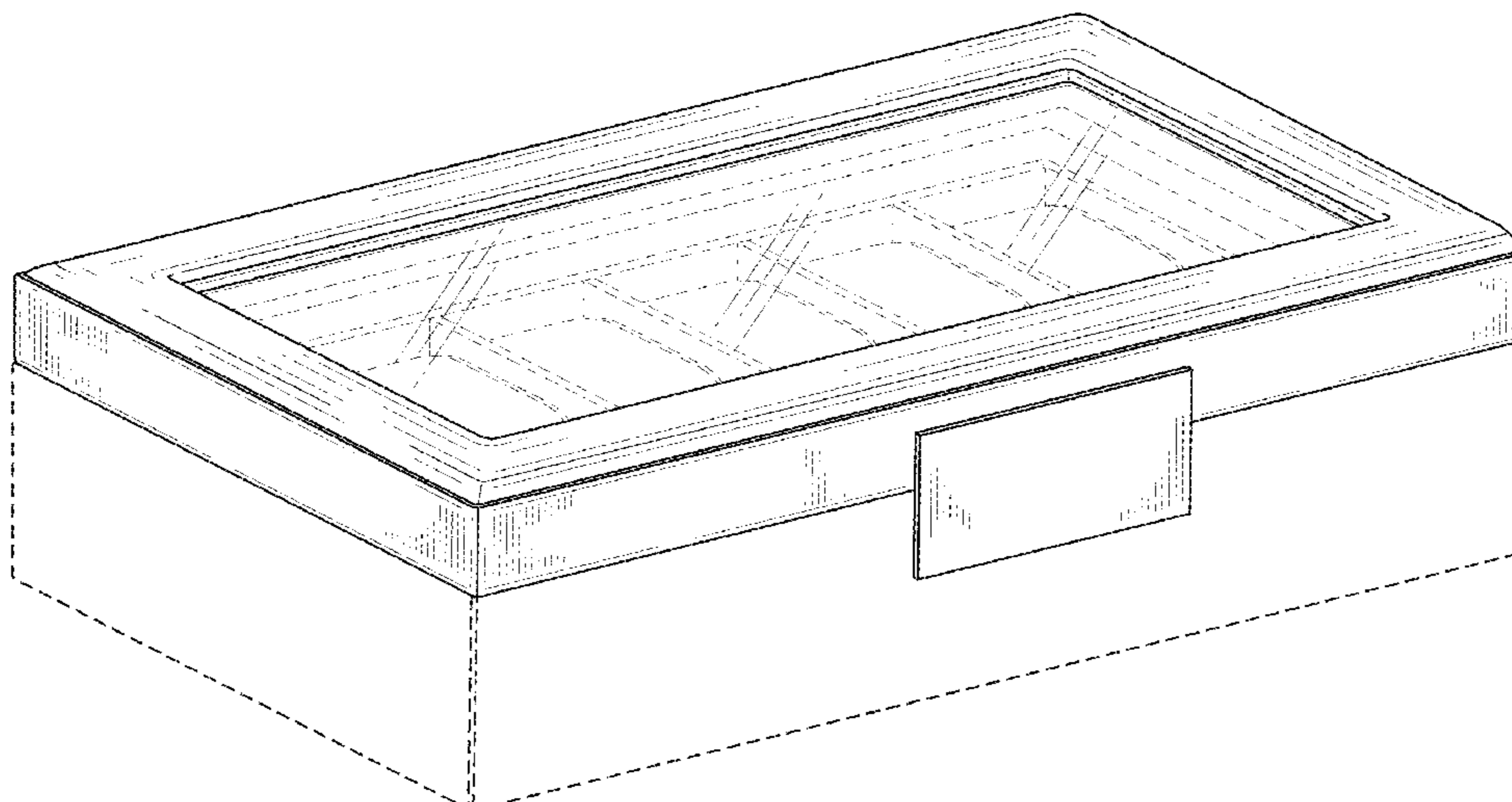

(56)

References Cited

U.S. PATENT DOCUMENTS

2,985,333 A \* 5/1961 Kirkman ..... A47B 88/90  
 220/533  
 D257,496 S \* 11/1980 Berkman ..... D6/631  
 D284,424 S \* 7/1986 Gotlib ..... D3/296  
 D287,800 S \* 1/1987 Lance ..... D6/559  
 D334,308 S \* 3/1993 Verina ..... D3/284  
 D351,073 S \* 10/1994 Palka ..... D6/671.1  
 5,692,605 A \* 12/1997 Lai ..... A45C 11/16  
 206/566  
 D390,106 S \* 2/1998 Dauphin ..... D9/760  
 D403,534 S \* 1/1999 Gregory ..... D6/559  
 D416,736 S \* 11/1999 Bergin ..... D6/559  
 D422,810 S \* 4/2000 Rasp ..... D6/691.4  
 D423,249 S \* 4/2000 Hawang ..... D6/667  
 D506,867 S \* 7/2005 Galan ..... D3/273  
 D587,495 S \* 3/2009 Levinger ..... D3/295  
 D613,522 S \* 4/2010 Kanthasamy ..... D6/667  
 D788,462 S \* 6/2017 Zhu ..... D3/294  
 2001/0017509 A1 \* 8/2001 Hallsten ..... E05B 64/46  
 312/333  
 2003/0205577 A1 \* 11/2003 Au ..... A45C 11/10  
 220/9.1

OTHER PUBLICATIONS

<[https://www.etsy.com/listing/170593689/sale-black-watch-display-case-large?ga\\_order=most\\_relevant&ga\\_\\_search\\_type=all&ga\\_view\\_type=gallery&ga\\_search\\_query=black%20jewelry%20box&ref=sr\\_gallery\\_31](https://www.etsy.com/listing/170593689/sale-black-watch-display-case-large?ga_order=most_relevant&ga__search_type=all&ga_view_type=gallery&ga_search_query=black%20jewelry%20box&ref=sr_gallery_31)>  
 (Year: 2013).\*  
 “Ebony Watch Case Jewelry Box” Mar. 25, 2014, annsfinegiftsblog.com, site visited Oct. 10, 2017 <[http://www.annsfinegiftsblog.com/img\\_8263/](http://www.annsfinegiftsblog.com/img_8263/)> (Year: 2014).\*  
 “Dumena jewelry box 6 watch box storage box factory custom watch box wholesale jewelry box can be customized” Jul. 24, 2013, shop.xilu.com, site visited Oct. 10, 2017 <[http://shop.xilu.com/product/0002\\_2013\\_07\\_24\\_18\\_7553508.html](http://shop.xilu.com/product/0002_2013_07_24_18_7553508.html)> (Year: 2013).\*  
 “Blush Shagreen Jewellery Box—Large” Mar. 9, 2016, amara.com, site visited Oct. 10, 2017 <<https://www.amara.com/products/blush-shagreen-jewellery-box-1>> (Year: 2016).\*

\* cited by examiner

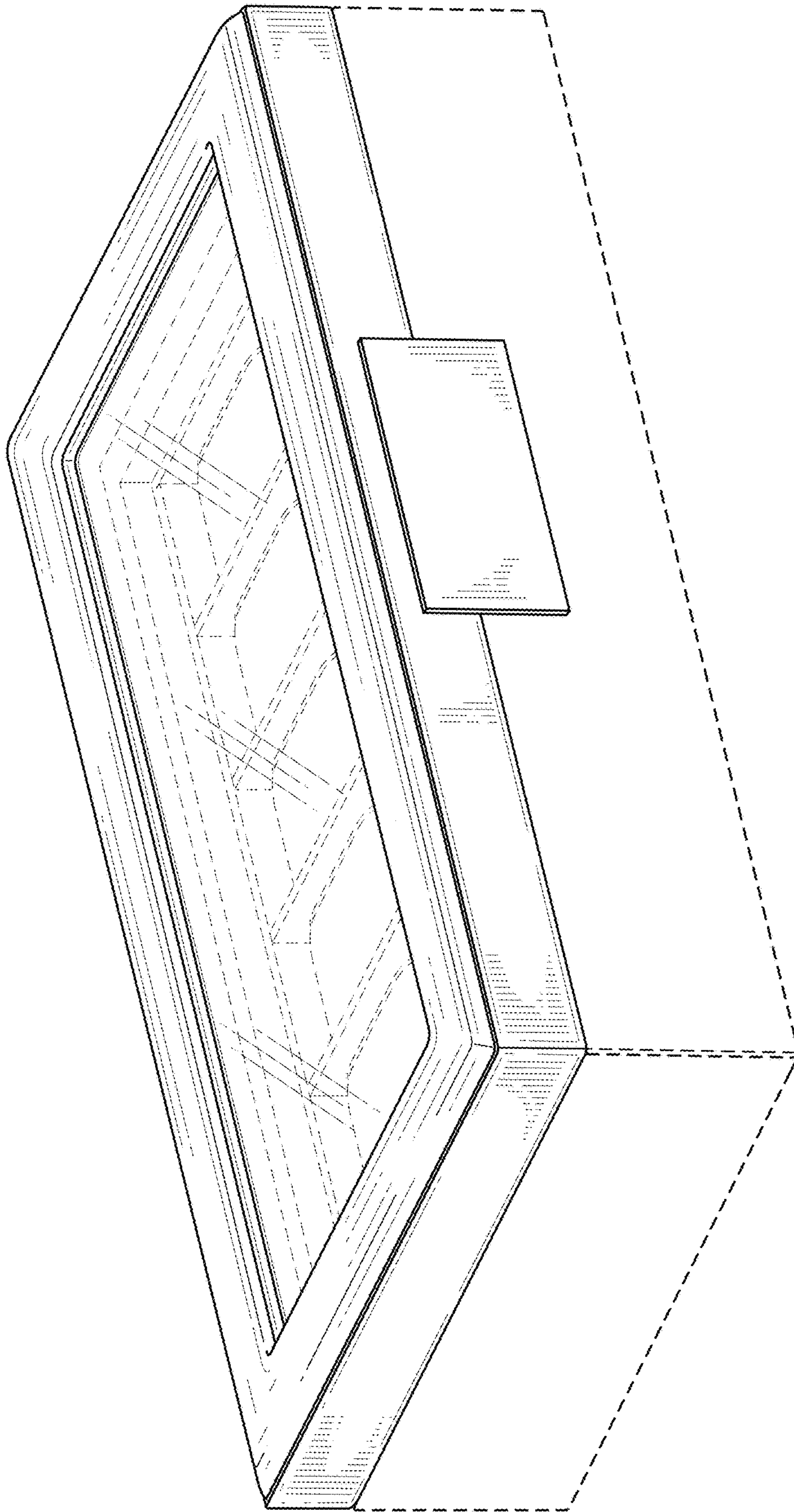

FIG. 1

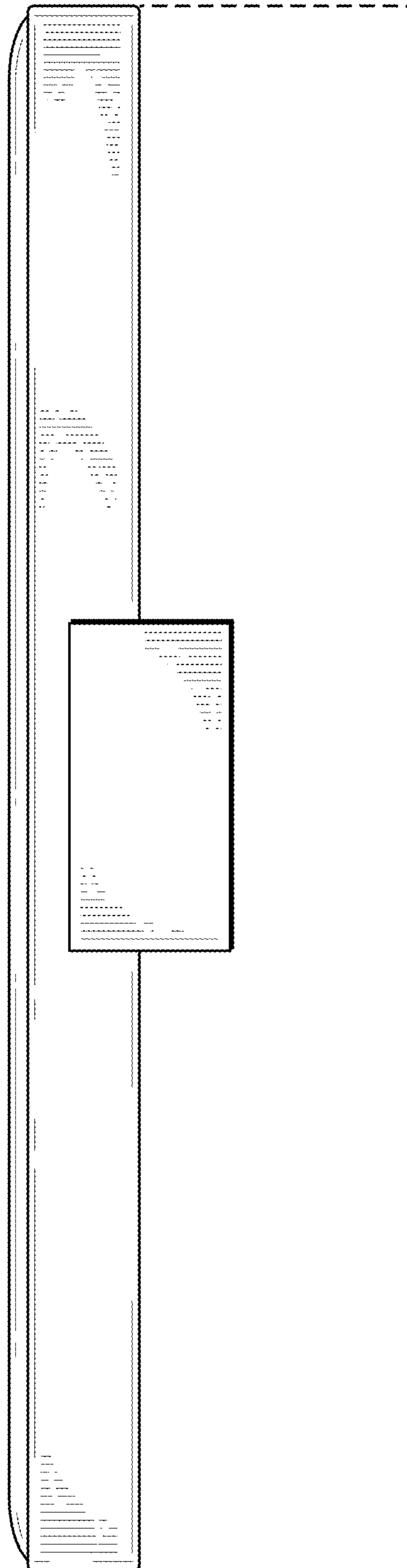

FIG. 2

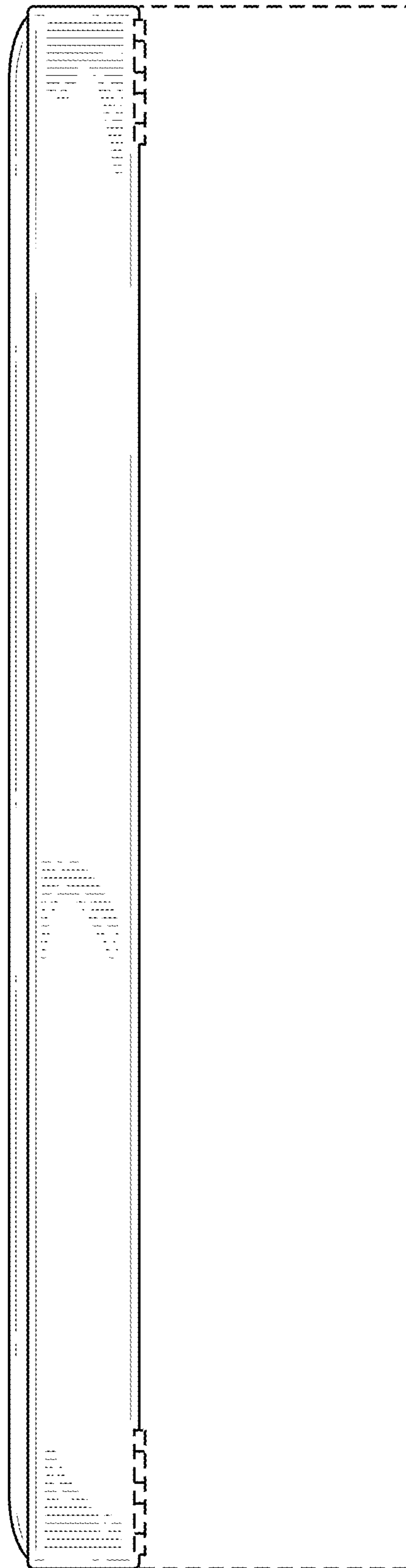

FIG. 3

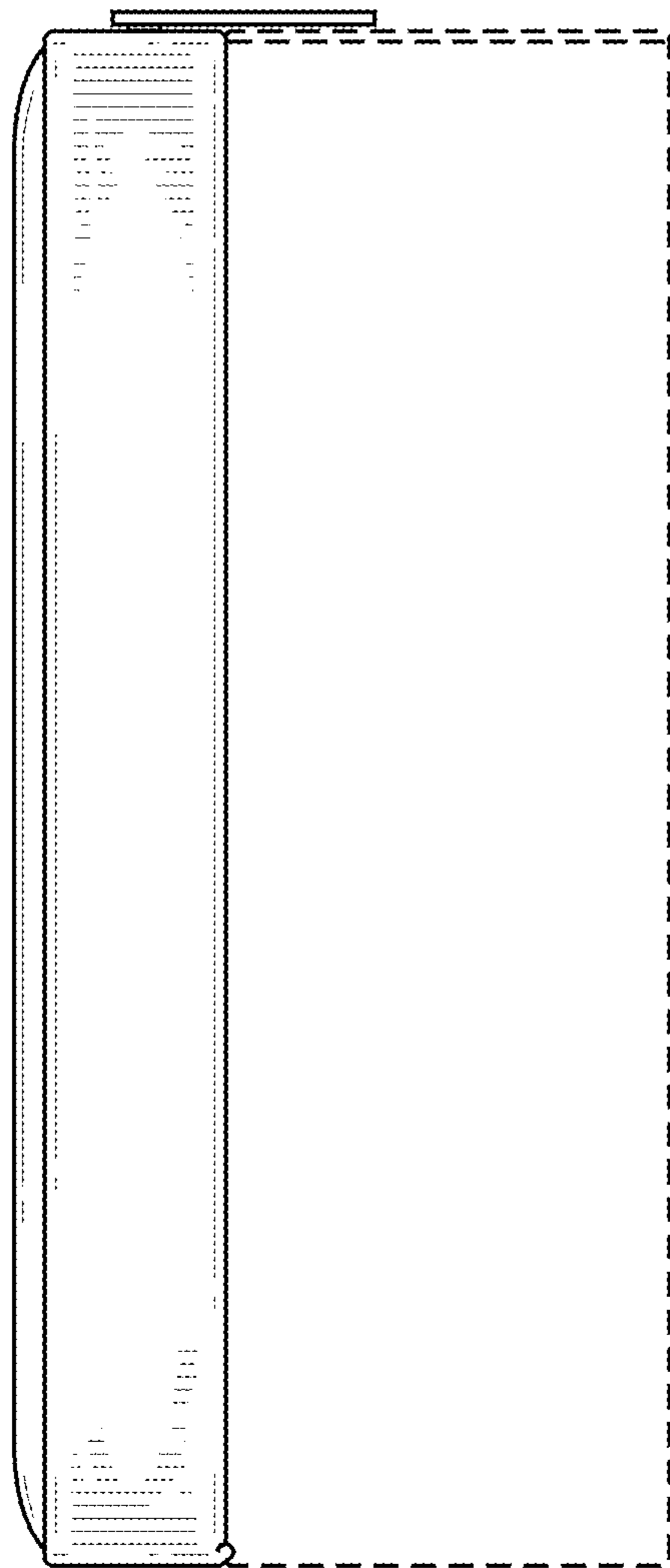

FIG. 4

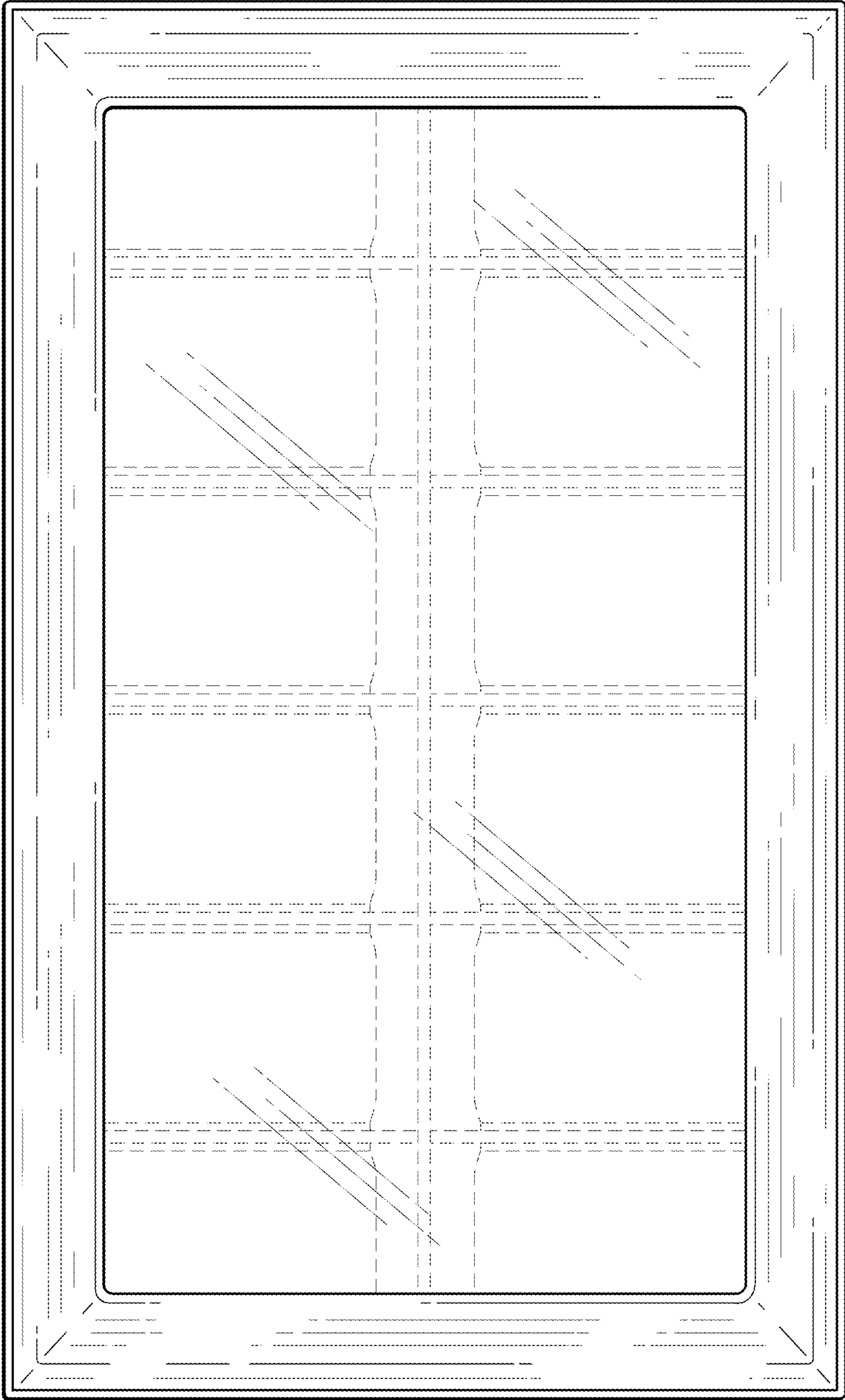

FIG. 5



FIG. 6



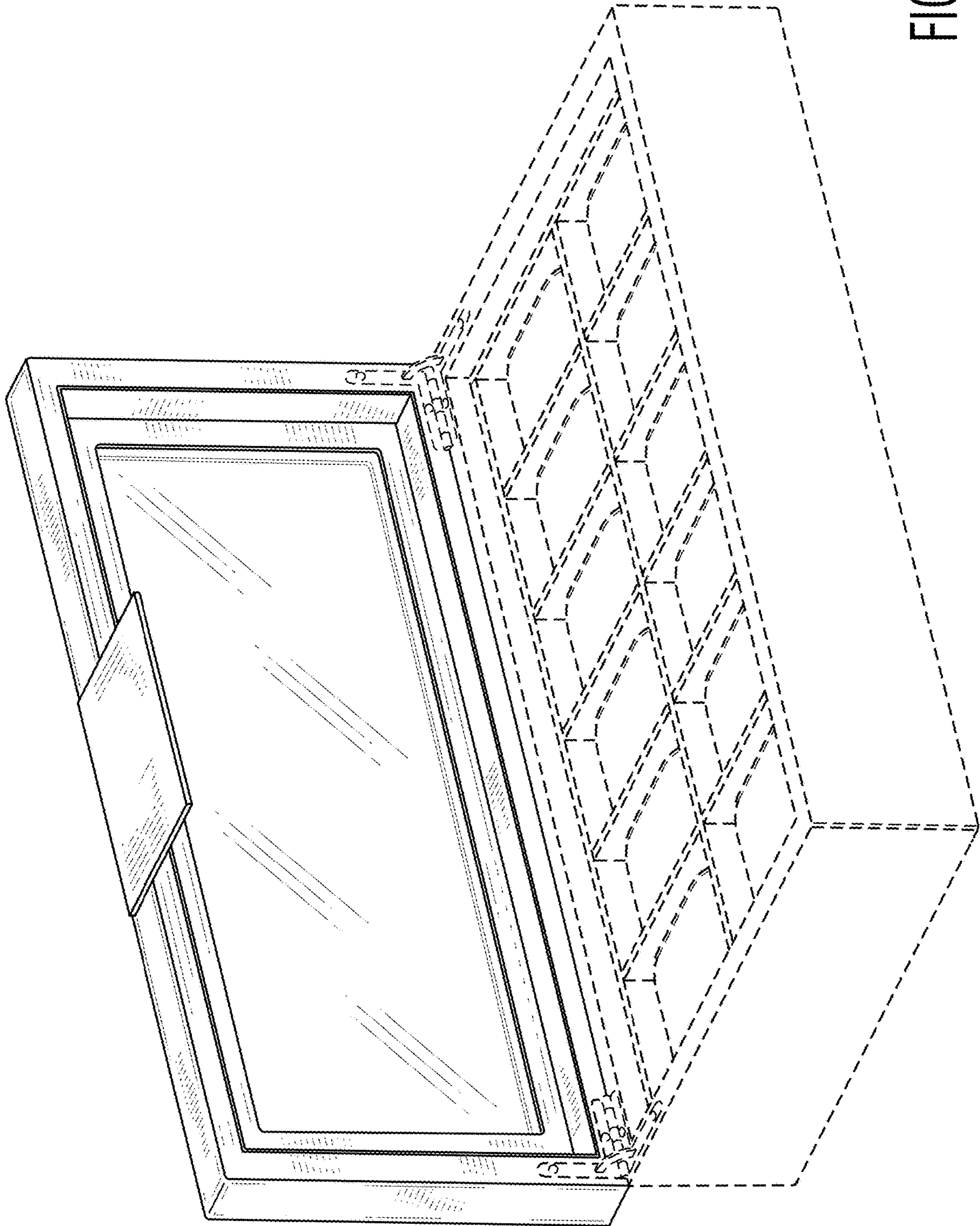

FIG. 7

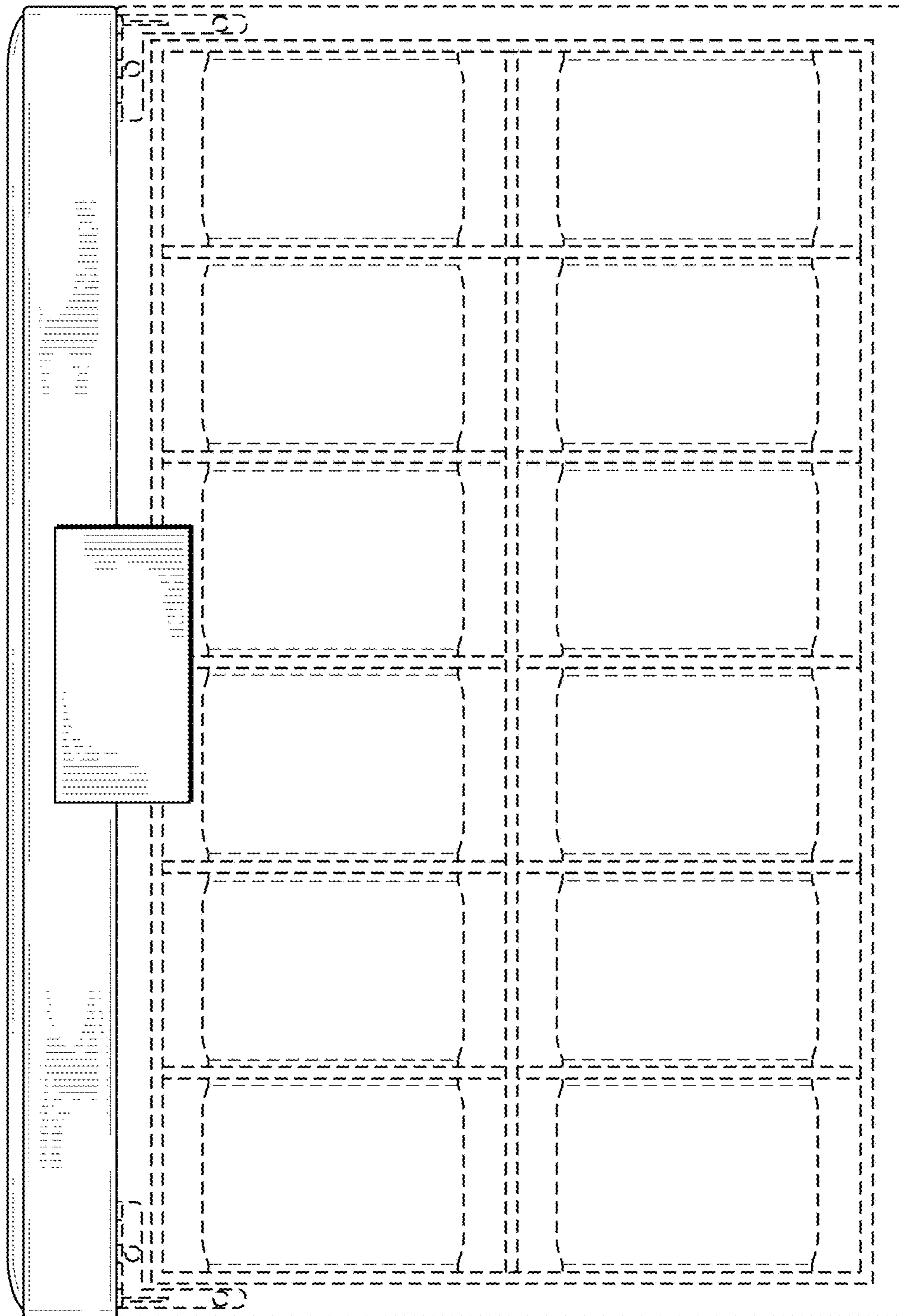

FIG. 8

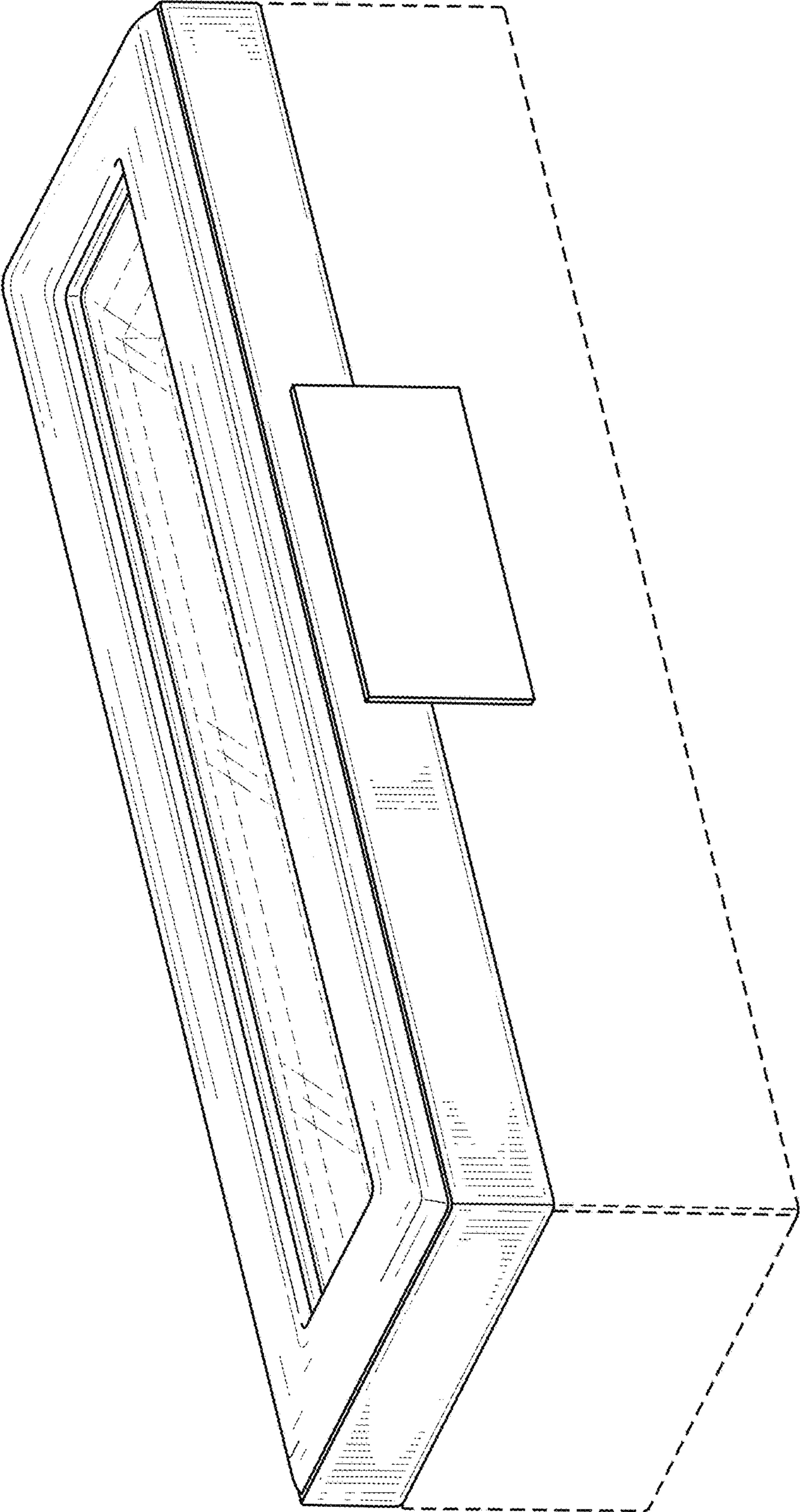

FIG. 9

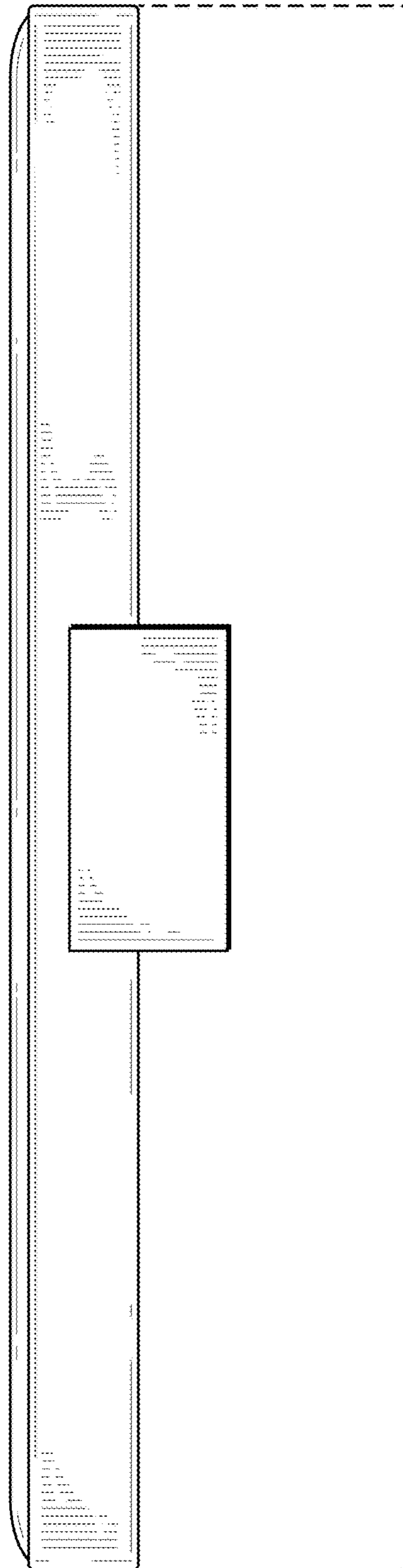

FIG. 10

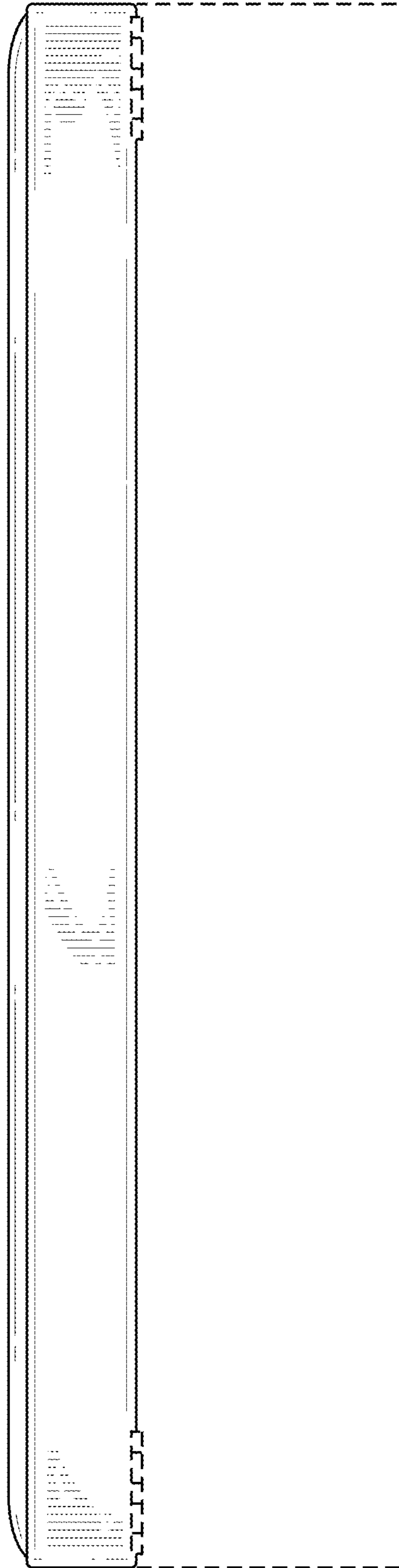

FIG. 11

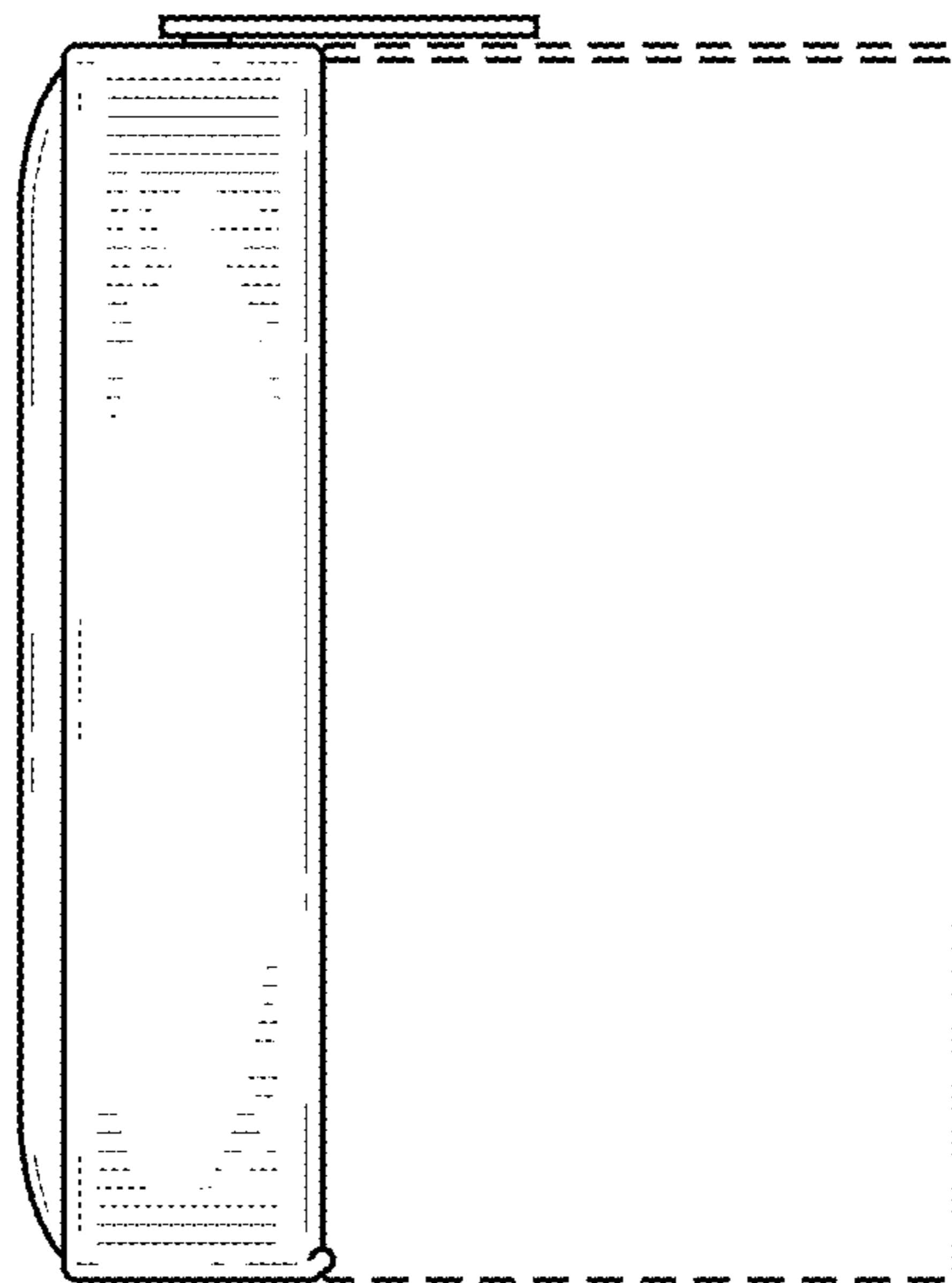

FIG. 12

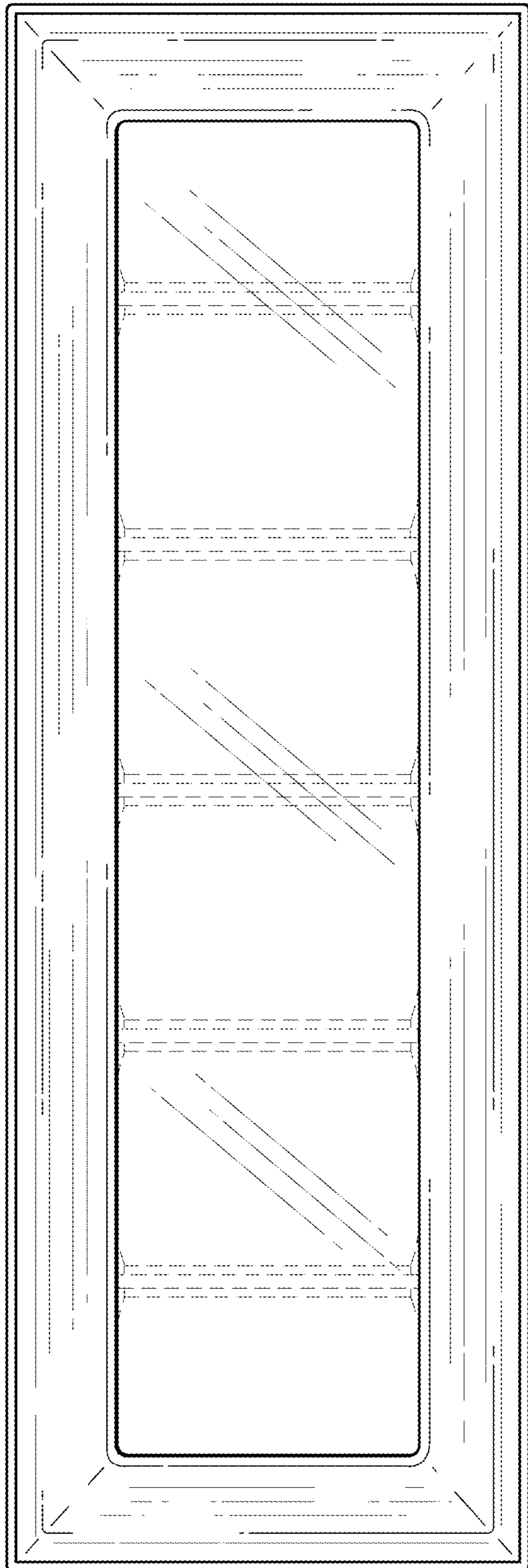

FIG. 13

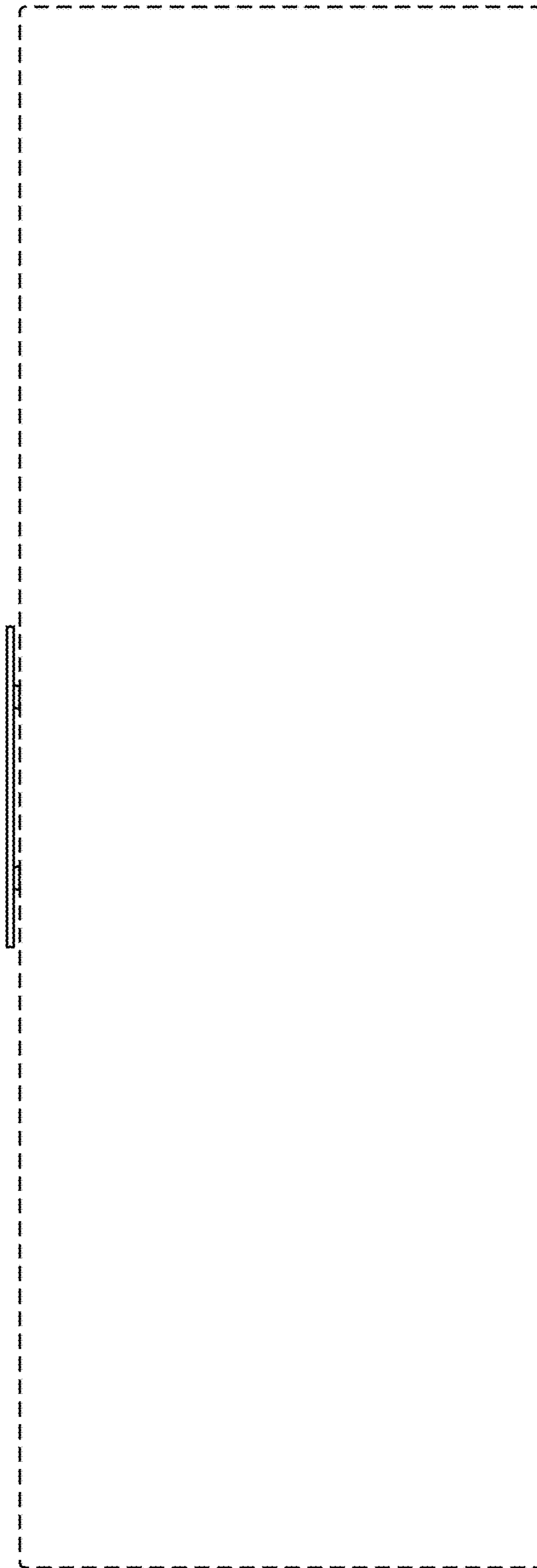

FIG. 14



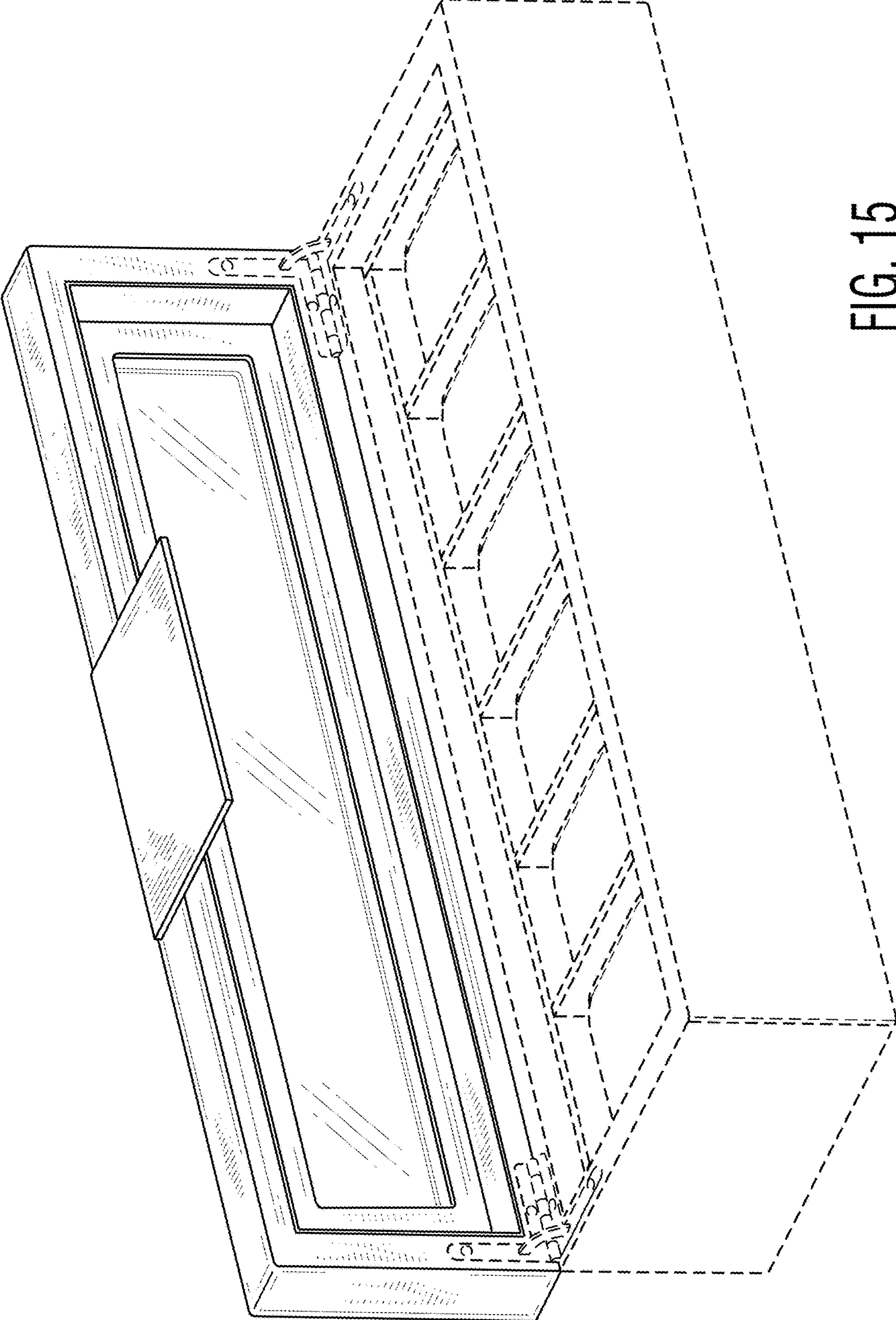

FIG. 15

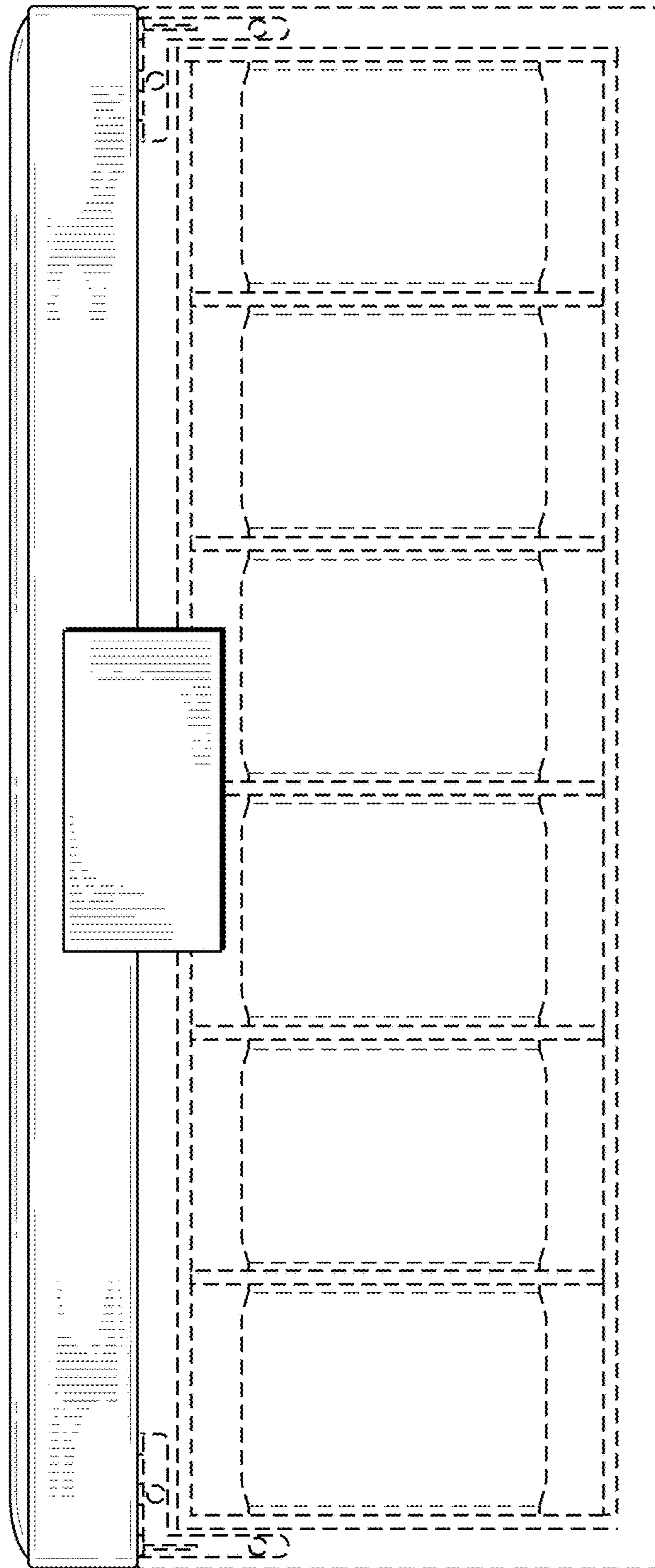

FIG. 16