



US00D812918S

(12) **United States Design Patent**  
**Walser**

(10) **Patent No.:** **US D812,918 S**  
(45) **Date of Patent:** **\*\* Mar. 20, 2018**

(54) **CHAIR**

(71) Applicant: **Inventor Group GmbH**, Wollerau  
(CH)

(72) Inventor: **Thomas Walser**, Kreuzlingen (CH)

(73) Assignee: **Inventor Group GmbH**, Wollerau  
(CH)

(\*\*) Term: **15 Years**

(21) Appl. No.: **29/546,750**

(22) Filed: **Nov. 25, 2015**

**Related U.S. Application Data**

(62) Division of application No. 29/487,105, filed on Apr. 4, 2014, now Pat. No. Des. 748,403.

(51) **LOC (11) Cl.** ..... **06-01**

(52) **U.S. Cl.**

USPC ..... **D6/352**

(58) **Field of Classification Search**

USPC ..... D6/334, 349–355, 363–364, 368–369,  
D6/374, 403, 685, 692–692.6, 708–708.25

CPC .... A47C 9/00–9/105; A47C 7/00–7/02; A47C  
16/00–16/04; A47B 7/00–7/02; A47B  
3/00; A47B 3/02; A47B 3/04; A47B 3/12

See application file for complete search history.

(56) **References Cited**

**U.S. PATENT DOCUMENTS**

D151,188 S \* 9/1948 Price et al. .... 297/462  
D348,361 S \* 7/1994 Beecher ..... D6/364  
D536,542 S \* 2/2007 Chiu ..... D6/352  
D560,378 S \* 1/2008 Audrito ..... D6/351  
D576,808 S \* 9/2008 Ton ..... D6/349

D579,675 S \* 11/2008 Paterson ..... D6/349  
D595,968 S \* 7/2009 Korban ..... D6/349  
D620,265 S \* 7/2010 Dewhurst ..... D6/345  
D623,430 S \* 9/2010 Walser ..... D6/349  
D650,182 S \* 12/2011 Andersson ..... D6/349  
D650,183 S \* 12/2011 Andersson ..... D6/349  
D670,094 S \* 11/2012 Prestandrea ..... D6/351  
D748,403 S \* 2/2016 Walser ..... D6/352  
D767,290 S \* 9/2016 Walser ..... D6/352  
9,655,455 B2 \* 5/2017 Barnett ..... A47C 4/54

\* cited by examiner

*Primary Examiner* — Vy N Koenig

(74) *Attorney, Agent, or Firm* — Smartpat PLC

(57) **CLAIM**

I claim the ornamental design for a chair, as shown and described.

**DESCRIPTION**

FIG. 1 is a top, front, side perspective view of a chair showing my new design without an optional pocket; FIG. 2 is a bottom, front, side perspective view thereof; FIG. 3 is a front view thereof, the rear view, left side view and right side view being identical; FIG. 4 is a top view thereof; FIG. 5 is a bottom view thereof; FIG. 6 is a top, front, right side perspective view of a chair showing my new design with the optional pocket; FIG. 7 is a bottom, front, right side perspective view thereof; FIG. 8 is a front view thereof; FIG. 9 is a rear view thereof; FIG. 10 is a left side view thereof; FIG. 11 is a right side view thereof; FIG. 12 is a top view thereof; and, FIG. 13 is a bottom view thereof.

**1 Claim, 13 Drawing Sheets**

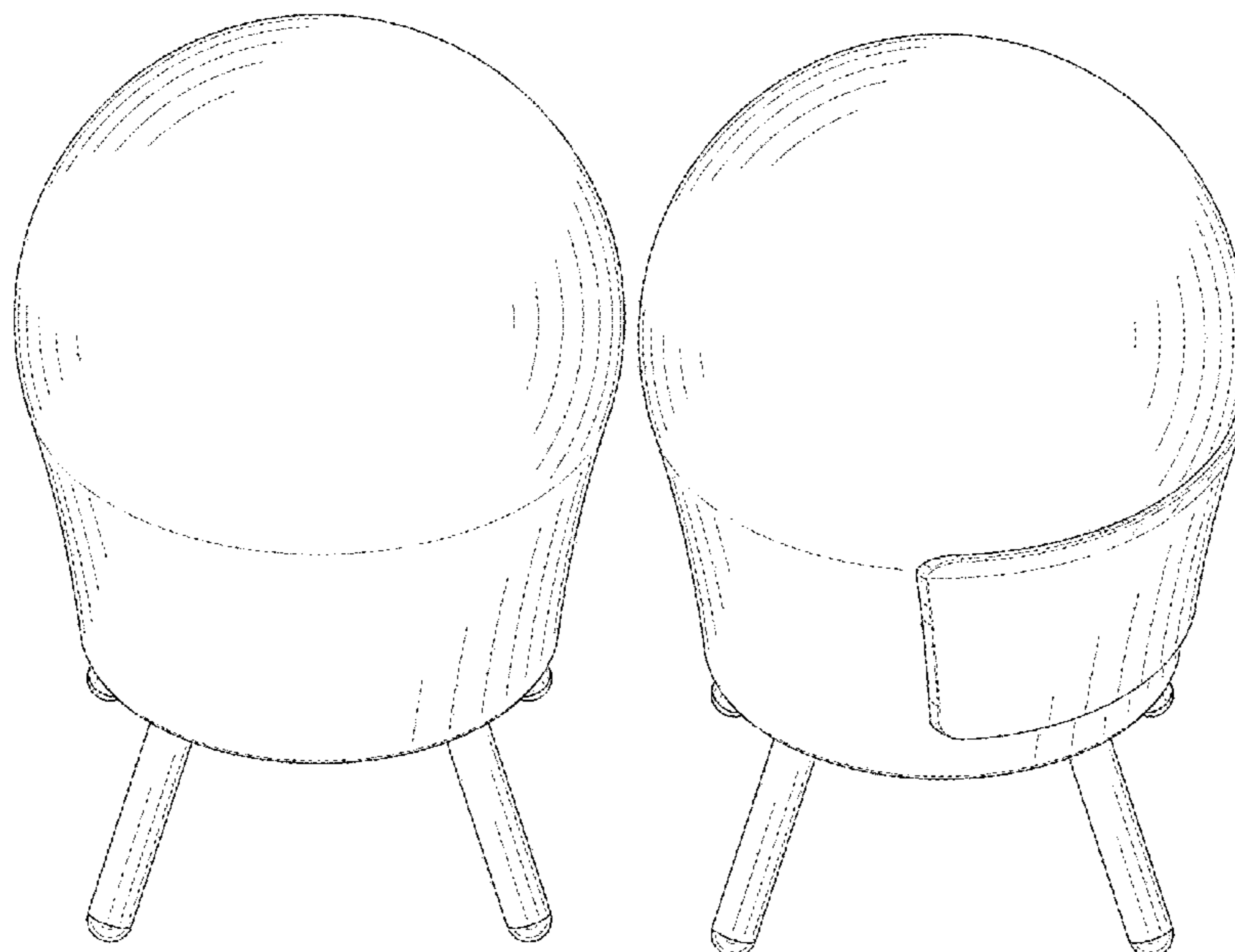

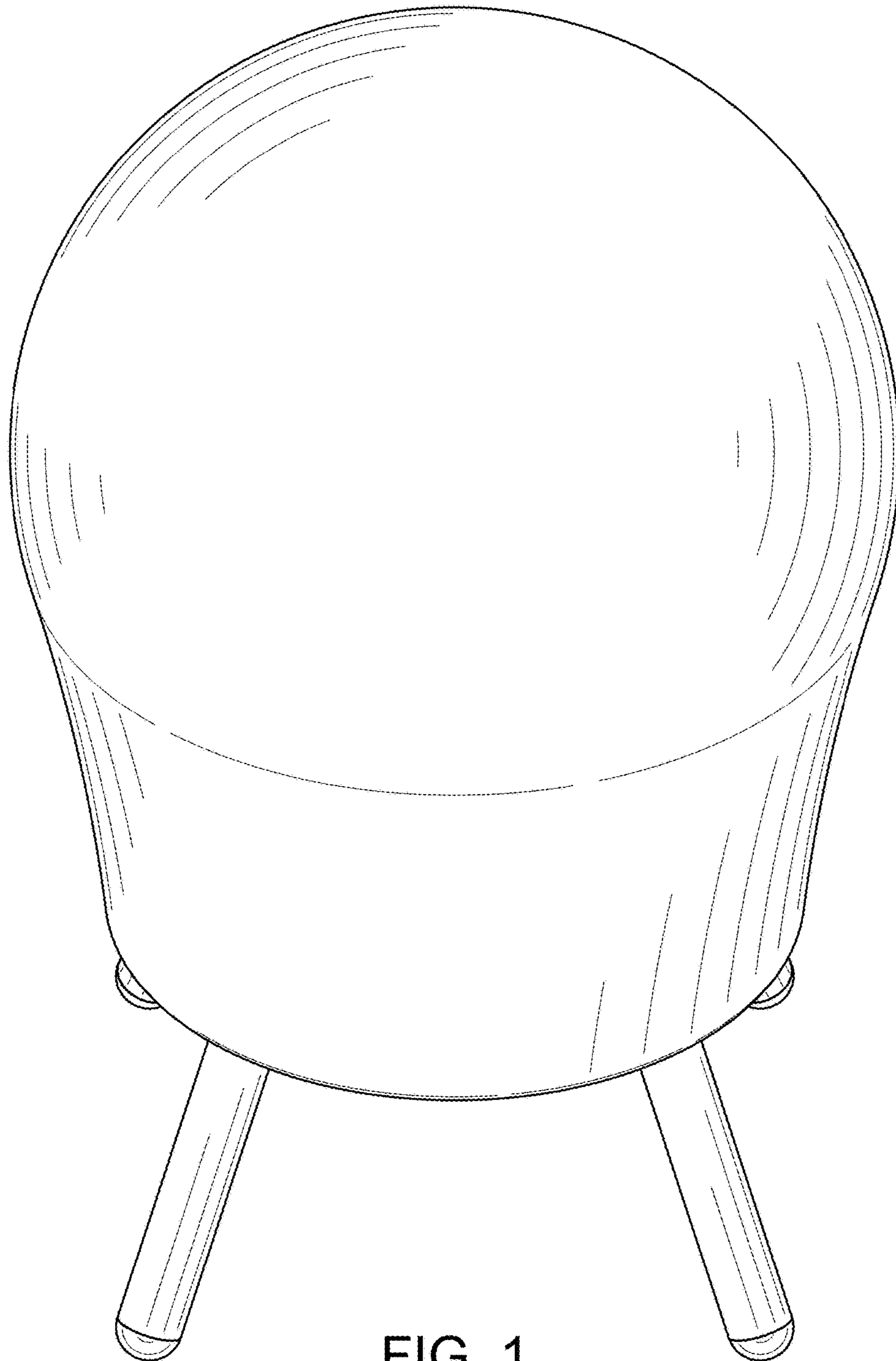

FIG. 1

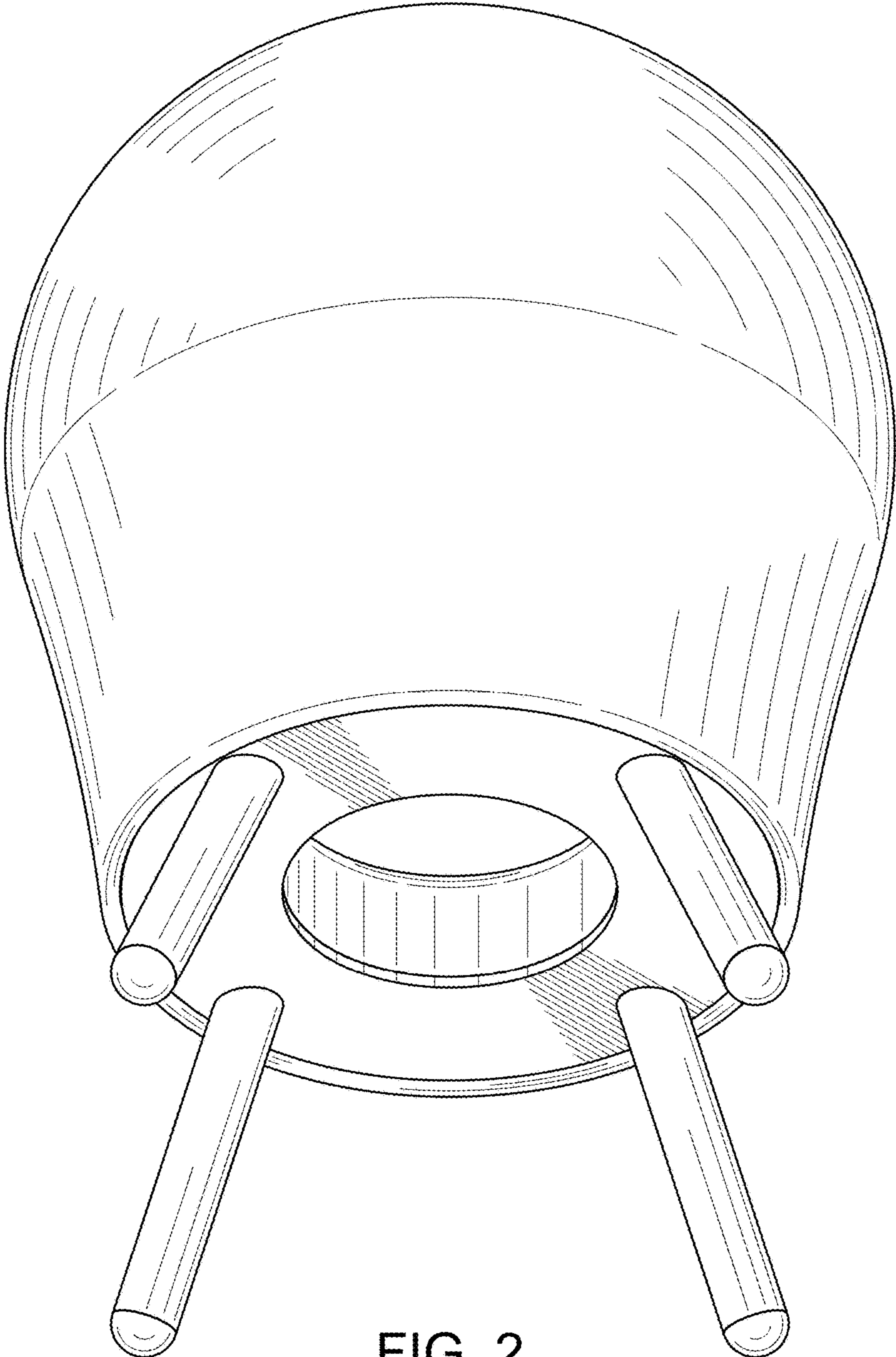

FIG. 2

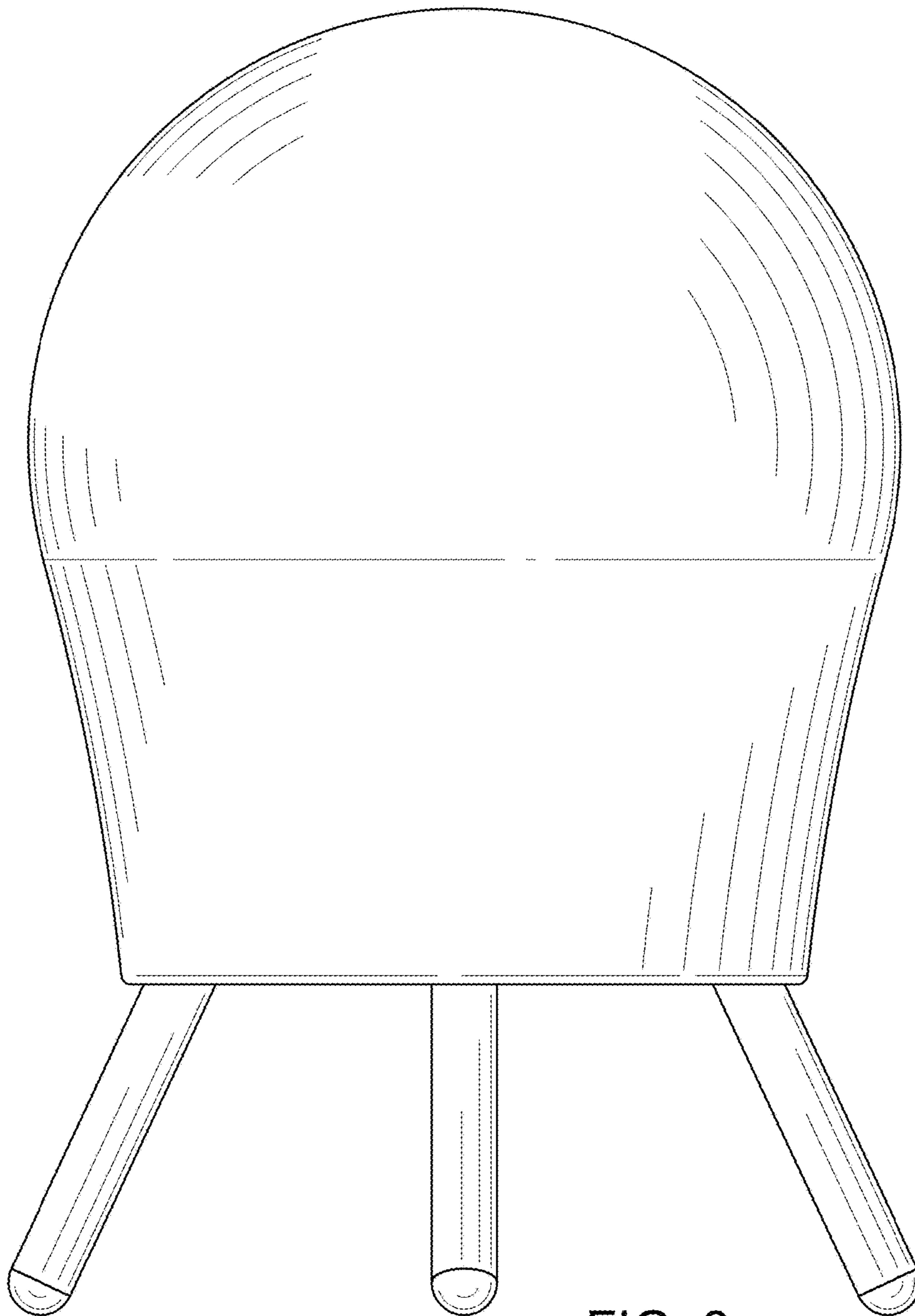

FIG. 3

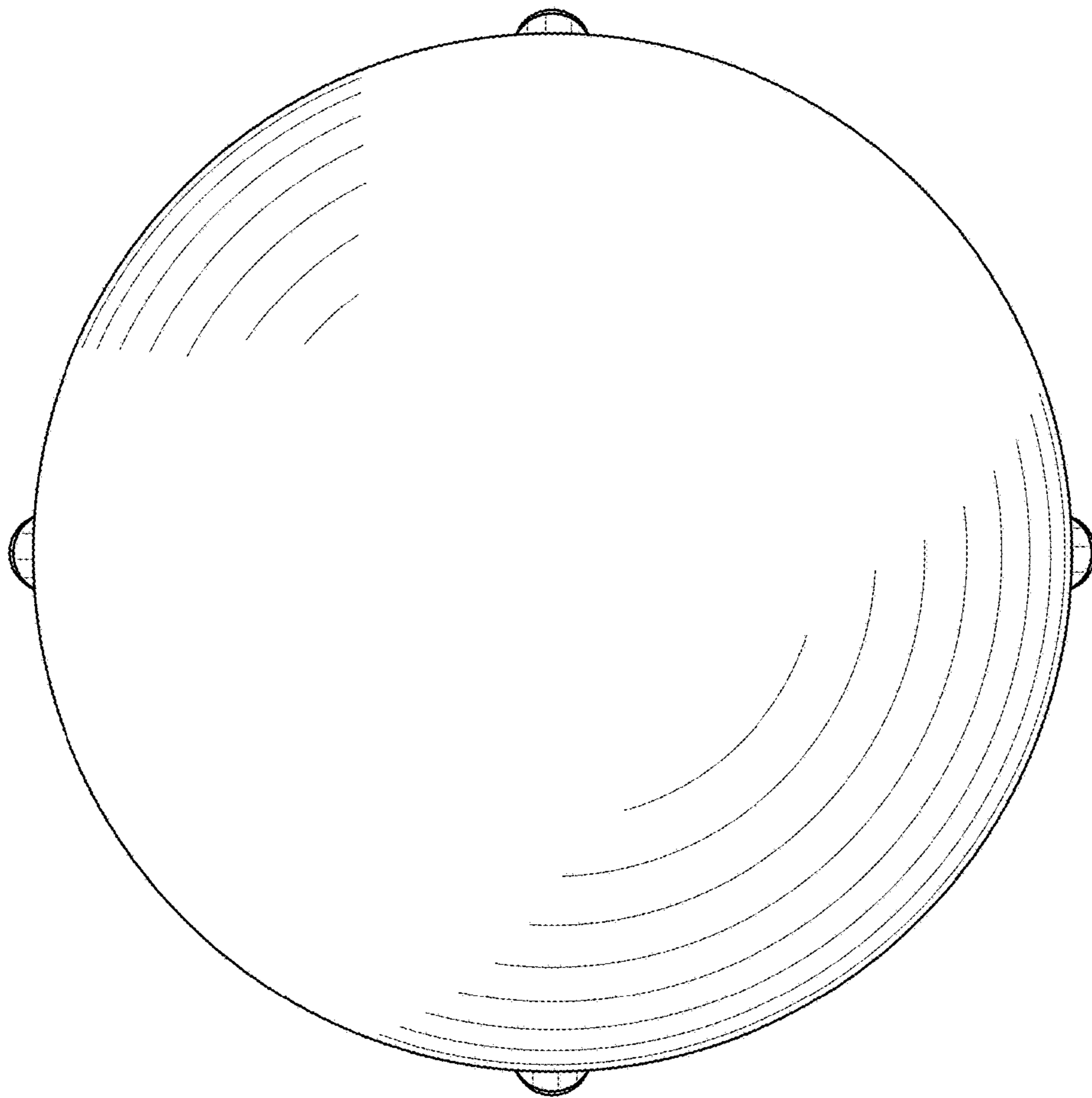

FIG. 4

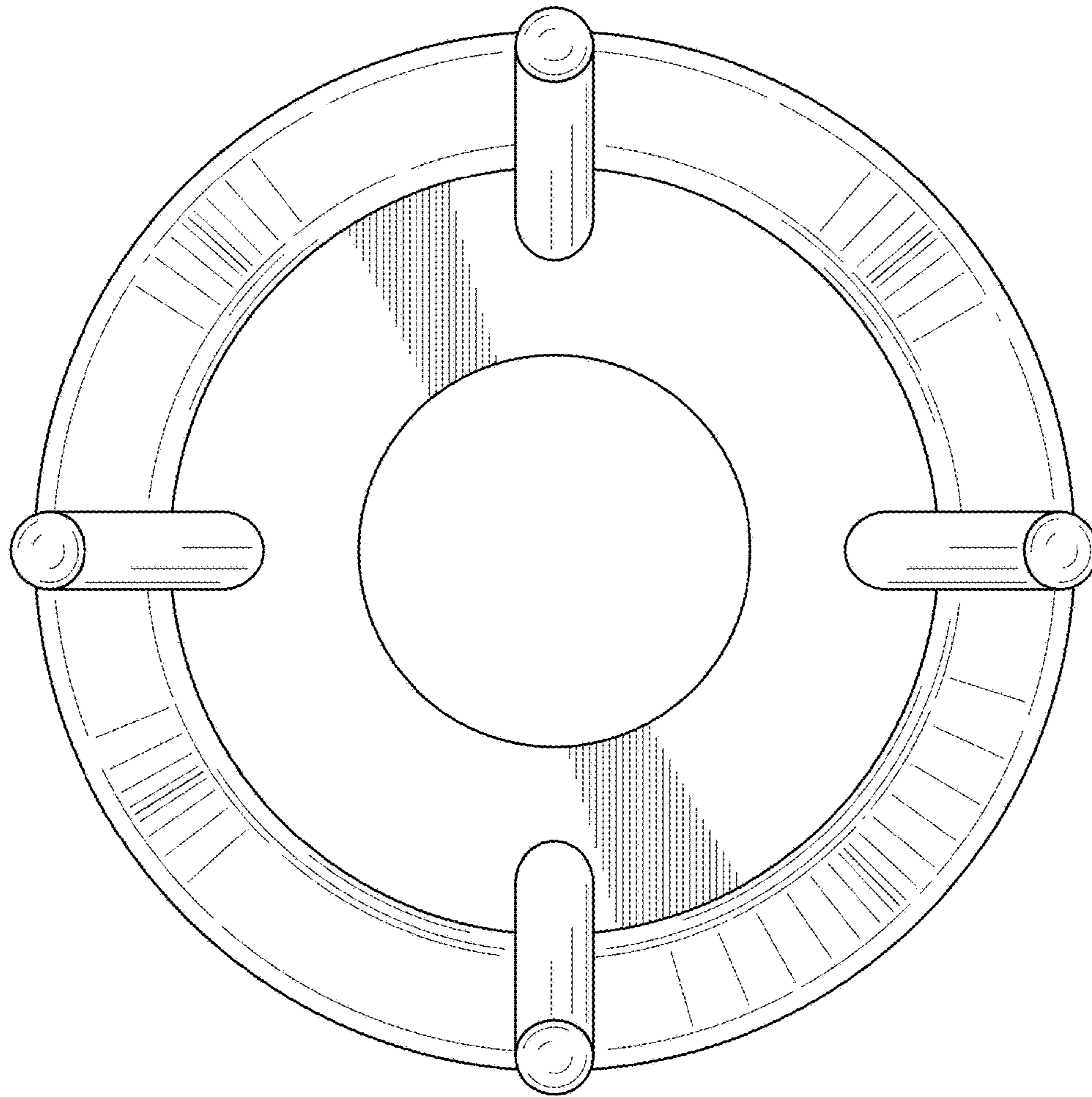

FIG. 5

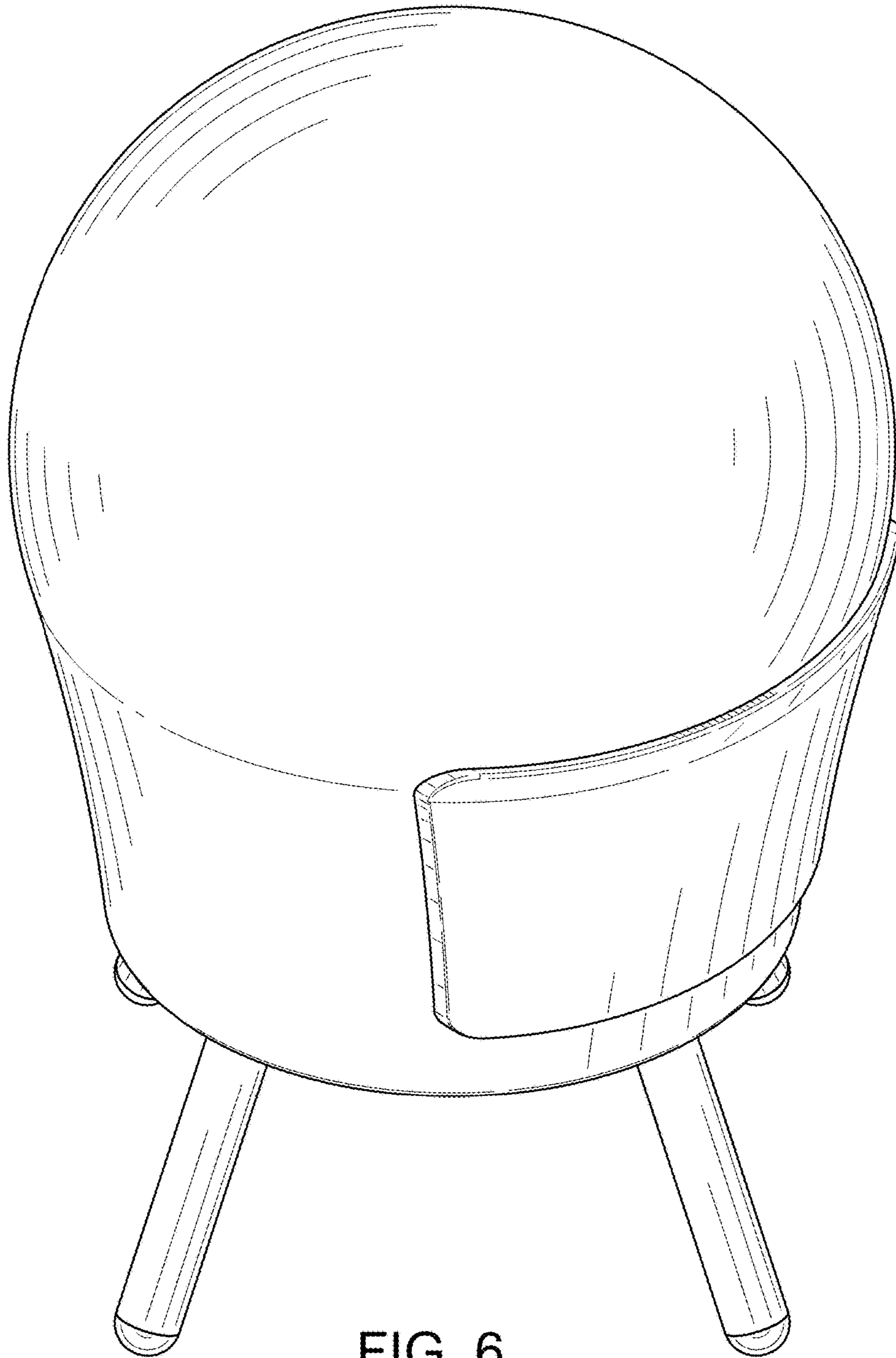

FIG. 6

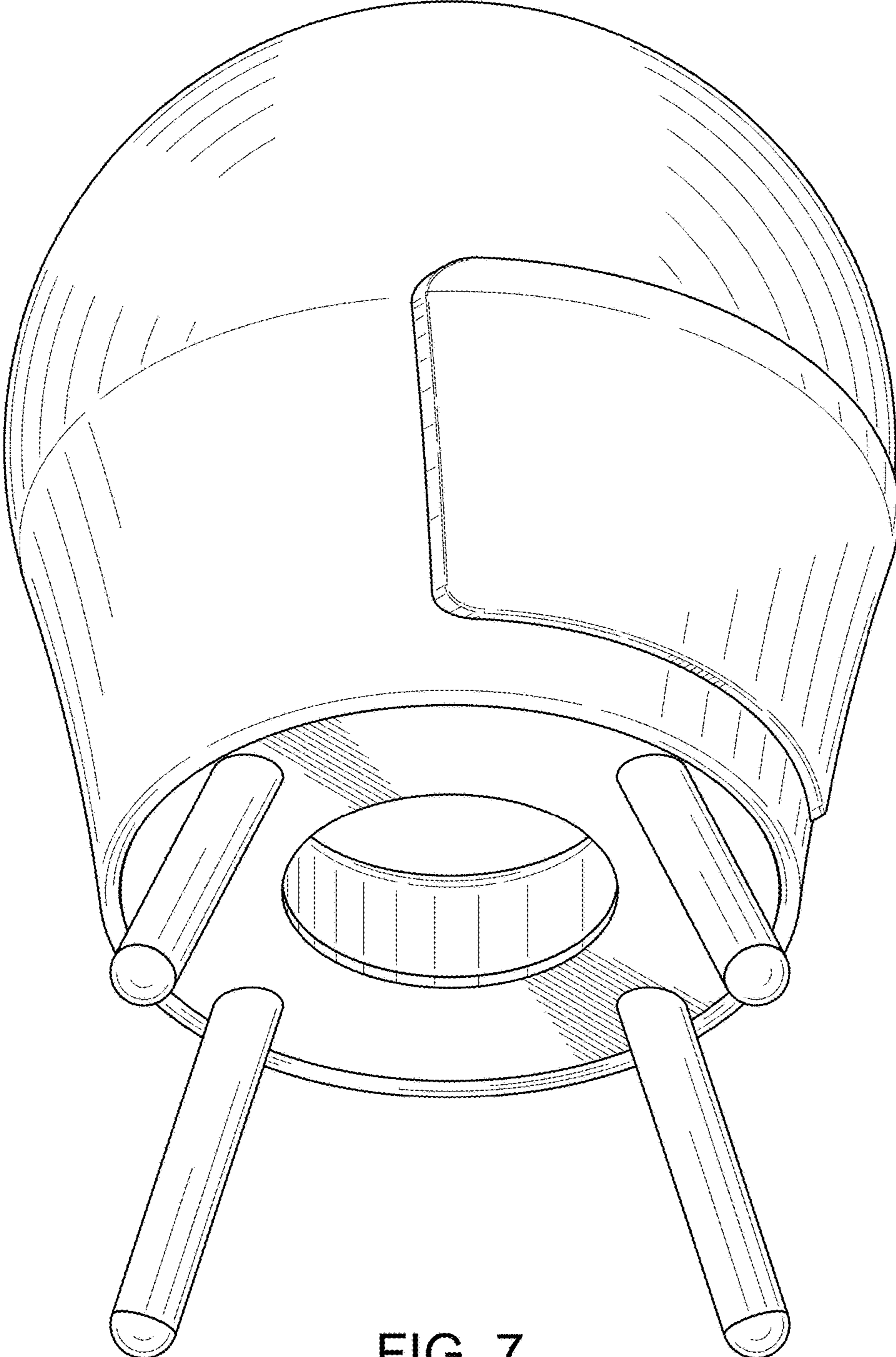

FIG. 7



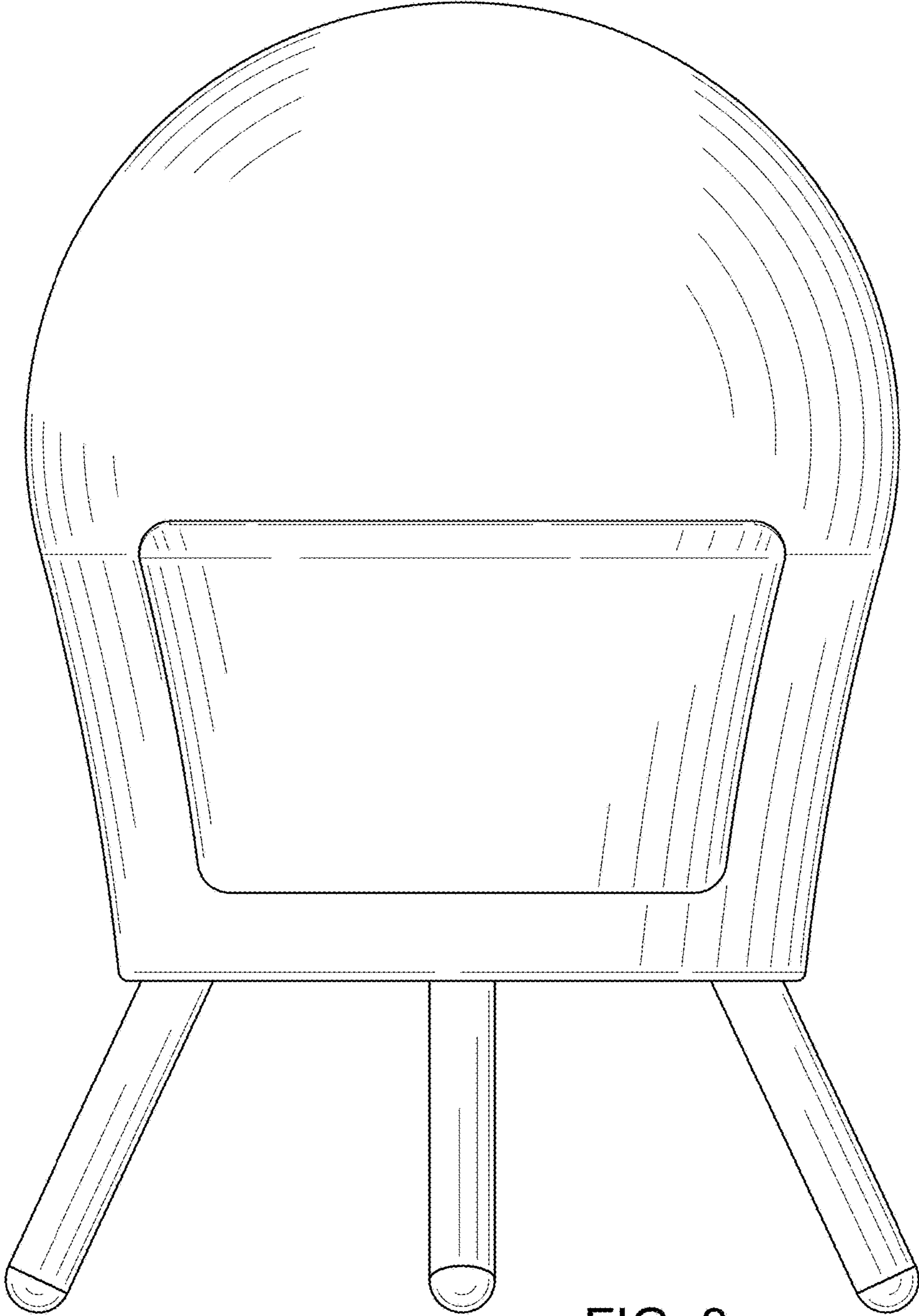

FIG. 8

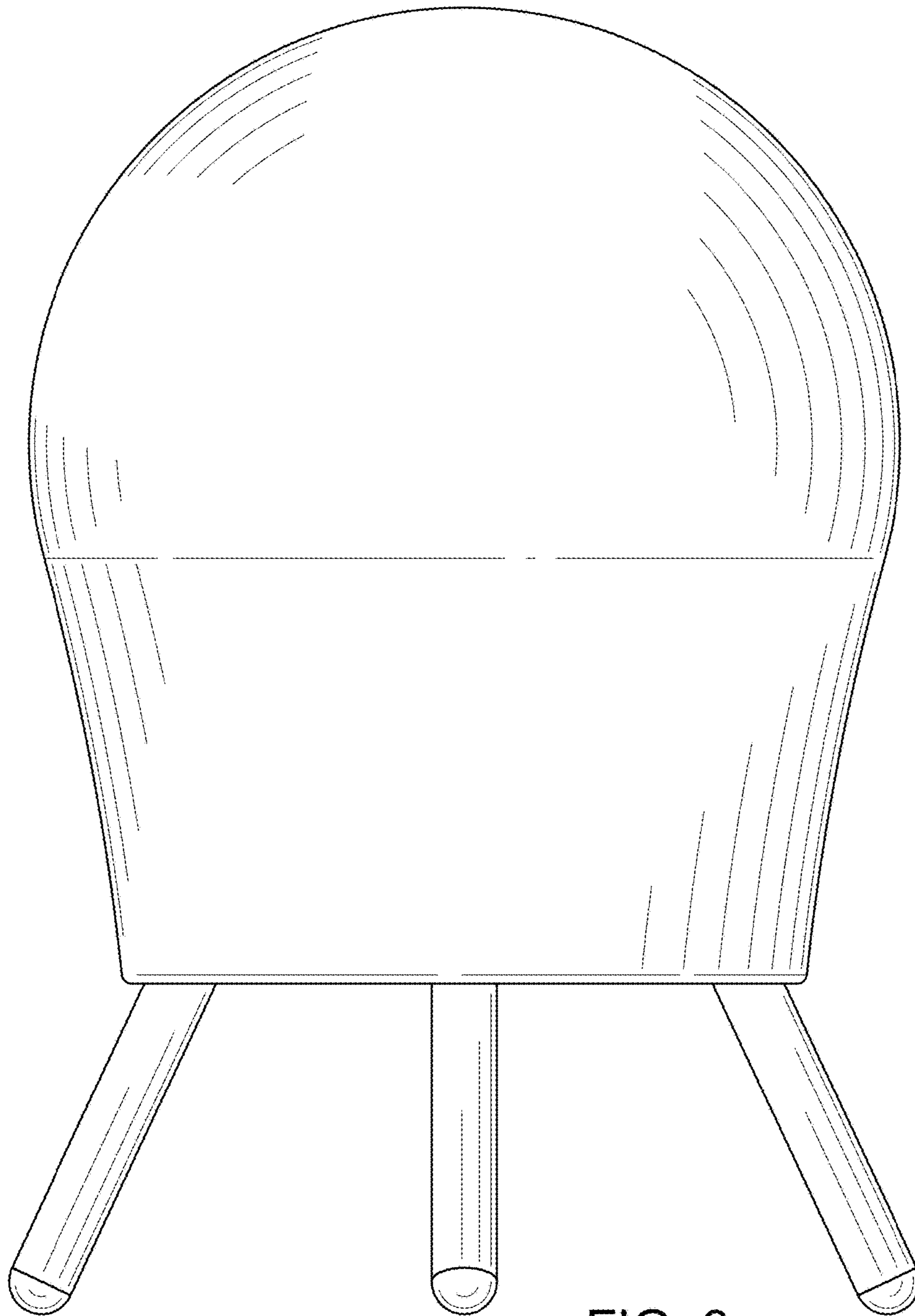

FIG. 9

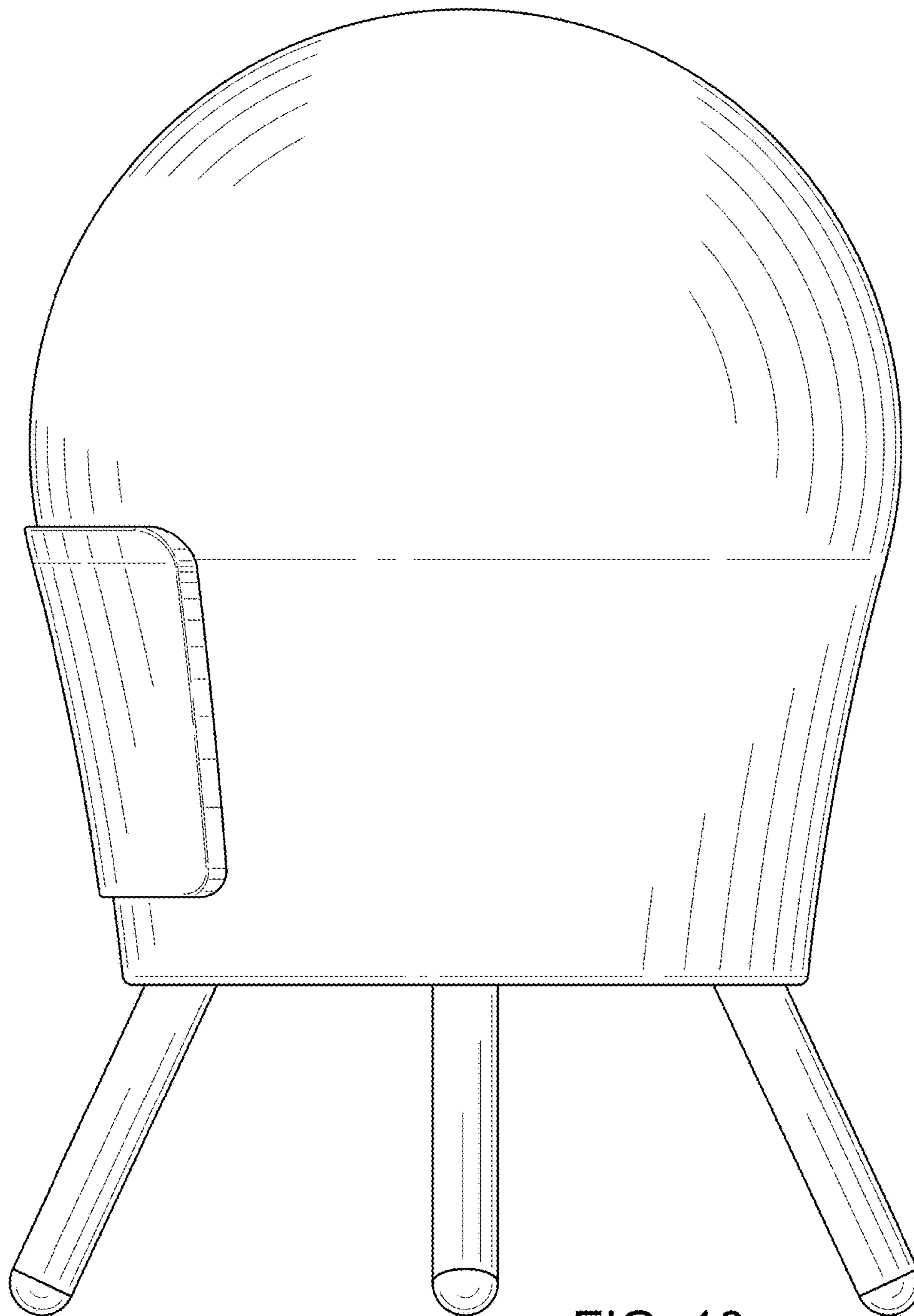

FIG. 10

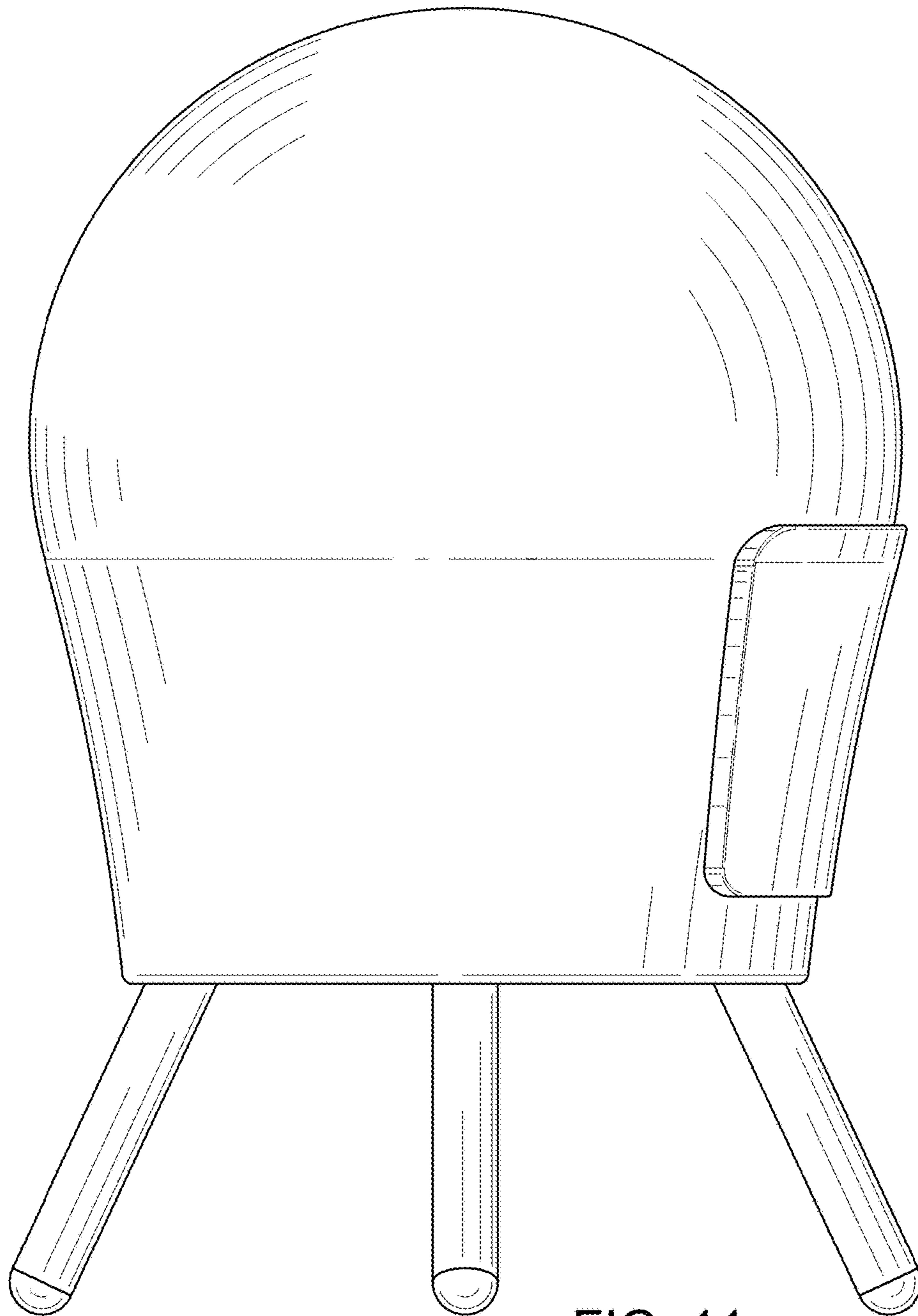

FIG. 11

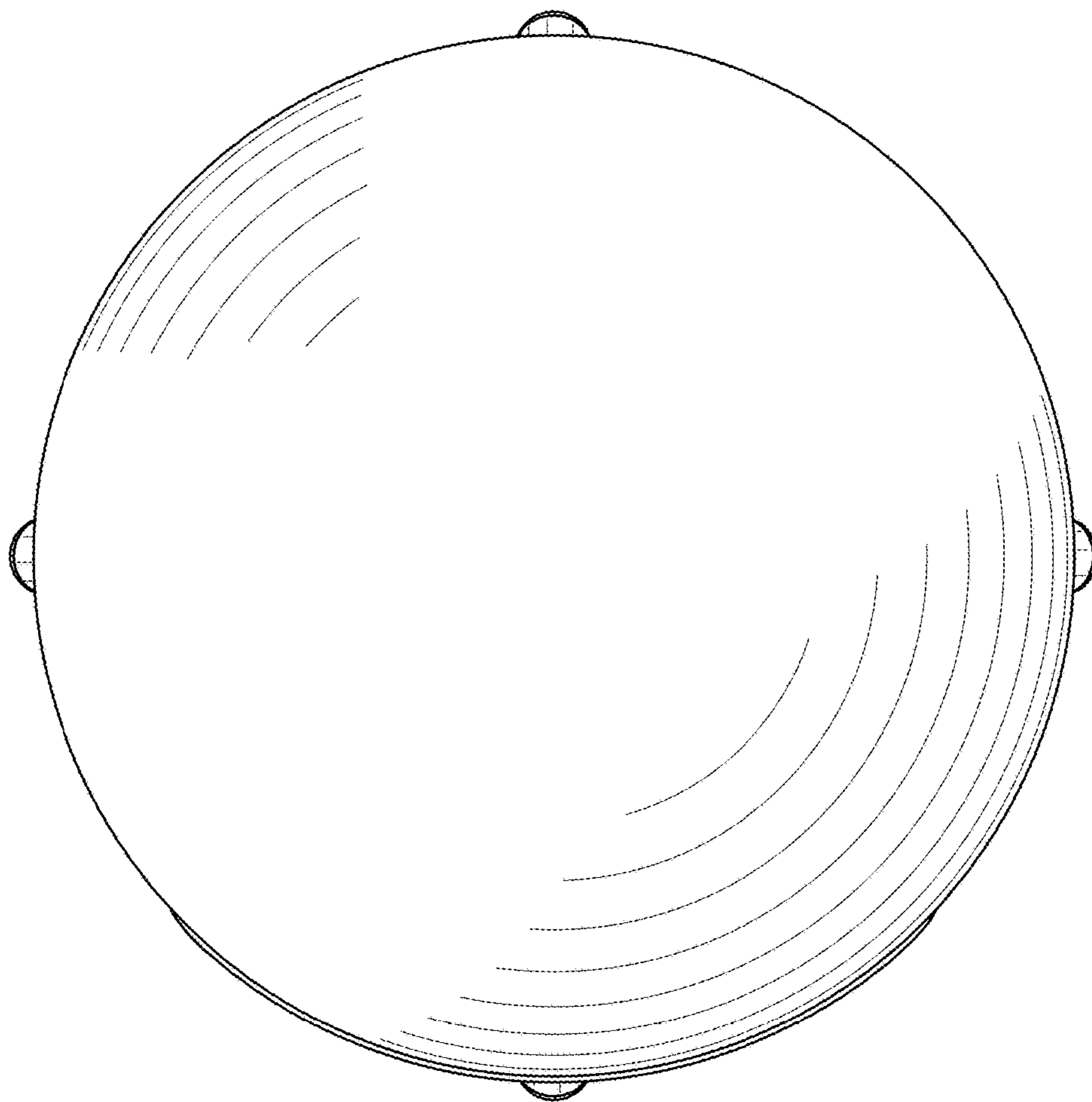

FIG. 12

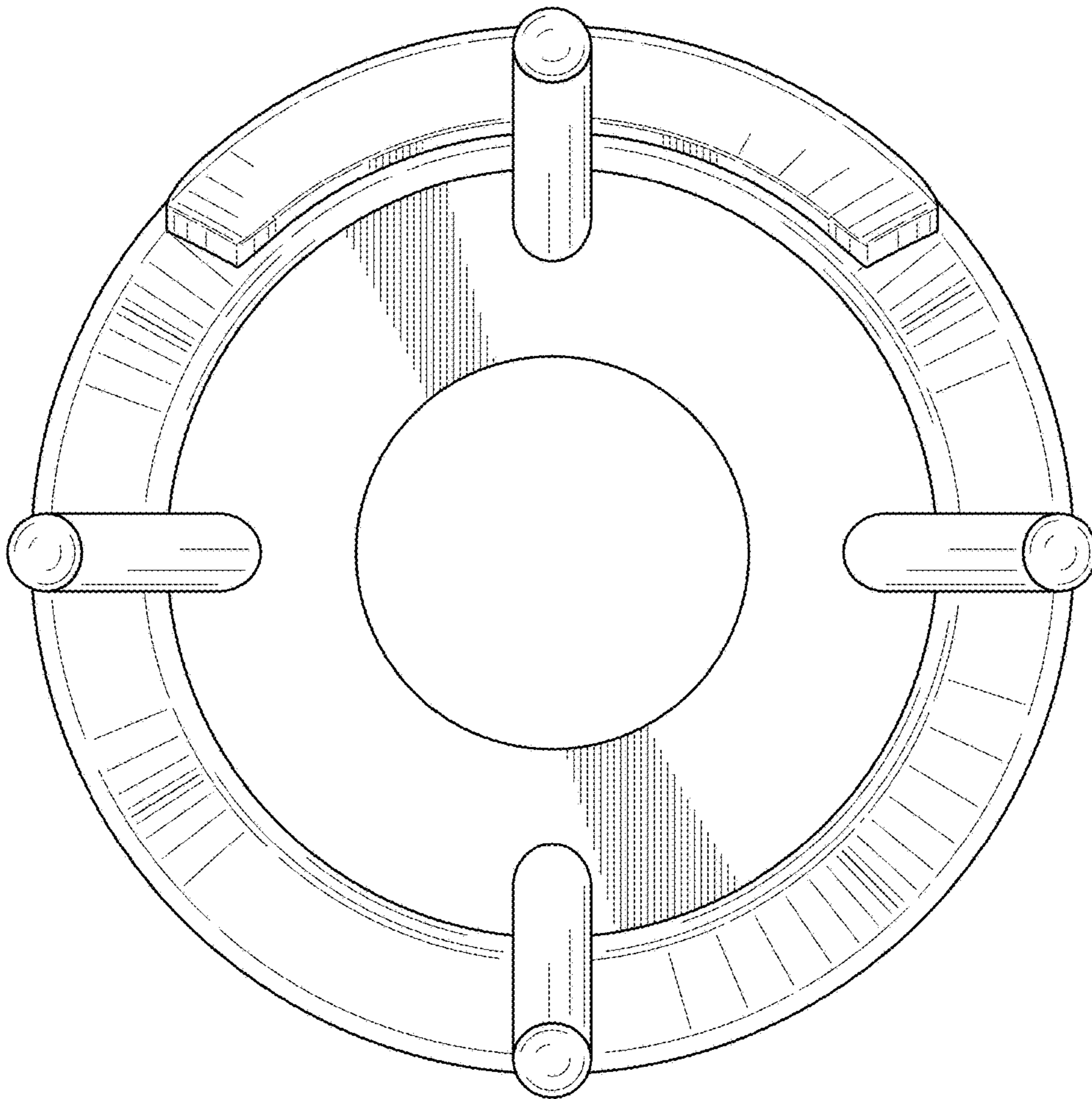

FIG. 13