



US00D812912S

(12) **United States Design Patent**
Eidenbenz

(10) **Patent No.:** **US D812,912 S**
(45) **Date of Patent:** **** Mar. 20, 2018**

(54) **INTERDENTAL CLEANER**
(71) Applicant: **Stefan Eidenbenz**, Zumikon (CH)
(72) Inventor: **Stefan Eidenbenz**, Zumikon (CH)
(**) Term: **15 Years**
(21) Appl. No.: **35/501,174**
(22) Filed: **May 6, 2016**

(80) **Hague Agreement Data**

Int. Filing Date: **May 6, 2016**
Int. Reg. No.: **DM/091227**
Int. Reg. Date: **May 6, 2016**
Int. Reg. Pub. Date: **Jul. 8, 2016**

(51) **LOC (11) Cl.** **04-02**
(52) **U.S. Cl.**
USPC **D4/111**
(58) **Field of Classification Search**
USPC D4/111, 101, 108, 104; D24/152, 147;
D28/65; 15/167.1; 106/35
CPC A46B 9/028; A61C 5/00
See application file for complete search history.

(56) **References Cited**

U.S. PATENT DOCUMENTS

5,244,933 A * 9/1993 Eidenbenz A61C 5/00
106/35
D411,684 S * 6/1999 Zaksenberg D4/111
D423,224 S * 4/2000 Sale D4/101
D480,563 S * 10/2003 Hensel D4/101
D489,534 S * 5/2004 Hensel D4/101
D628,809 S * 12/2010 Daniel D4/108
D638,628 S * 5/2011 Nanda D24/147
D696,023 S * 12/2013 Gebski D4/101
D701,388 S * 3/2014 Chuanzhou D4/101
D703,955 S * 5/2014 Nanda D4/104
D710,113 S * 8/2014 Cho D4/111

8,813,292 B2 * 8/2014 Driesen A46B 9/028
15/167.1
D715,561 S * 10/2014 Erskine-Smith D4/111
D763,578 S * 8/2016 Kato D4/111
D775,765 S * 1/2017 Schmidt D28/65
D776,438 S * 1/2017 Sedic D4/111
D779,830 S * 2/2017 Booth D4/104
D787,128 S * 5/2017 Butz D28/65
D788,304 S * 5/2017 Kikkawa D24/152
D788,305 S * 5/2017 Kikkawa D24/152

* cited by examiner

Primary Examiner — Rhea Shields

(57) **CLAIM**

The ornamental design for an interdental cleaner, as shown and described.

DESCRIPTION

- 1.-2. Interdental cleaner
- 1.1 : Perspective
- 1.2 : Perspective
- 1.3 : Bottom
- 1.4 : Top
- 1.5 : Left
- 1.6 : Right
- 1.7 : Back
- 1.8 : Front
- 2.1 : Perspective
- 2.2 : Perspective
- 2.3 : Bottom
- 2.4 : Top
- 2.5 : Left
- 2.6 : Right
- 2.7 : Back
- 2.8 : Front

Design 1 consists of an interdental cleaner with a holder and a refill; design 2 is a refill for interdental cleaner.

1 Claim, 16 Drawing Sheets

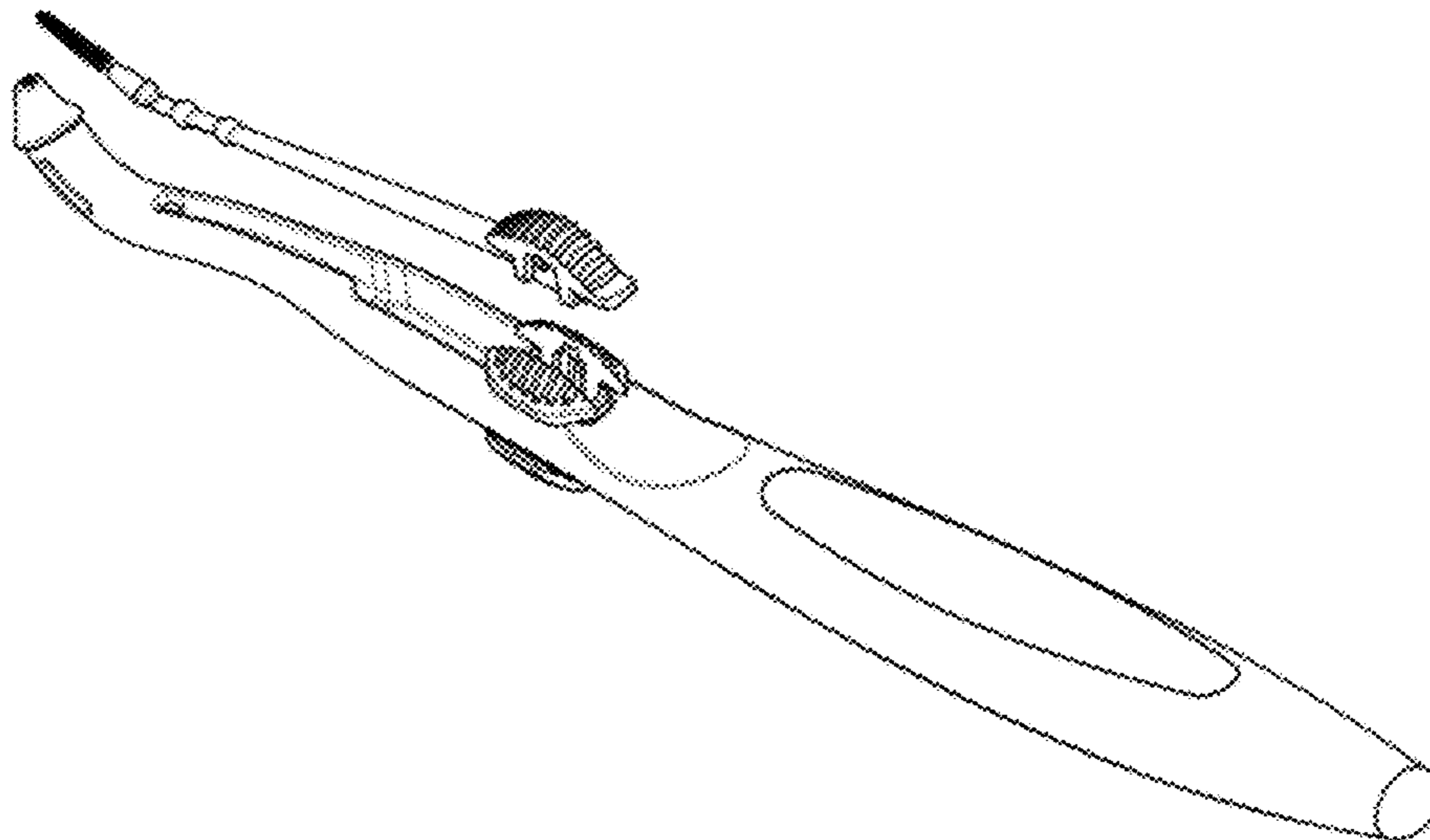

1.1

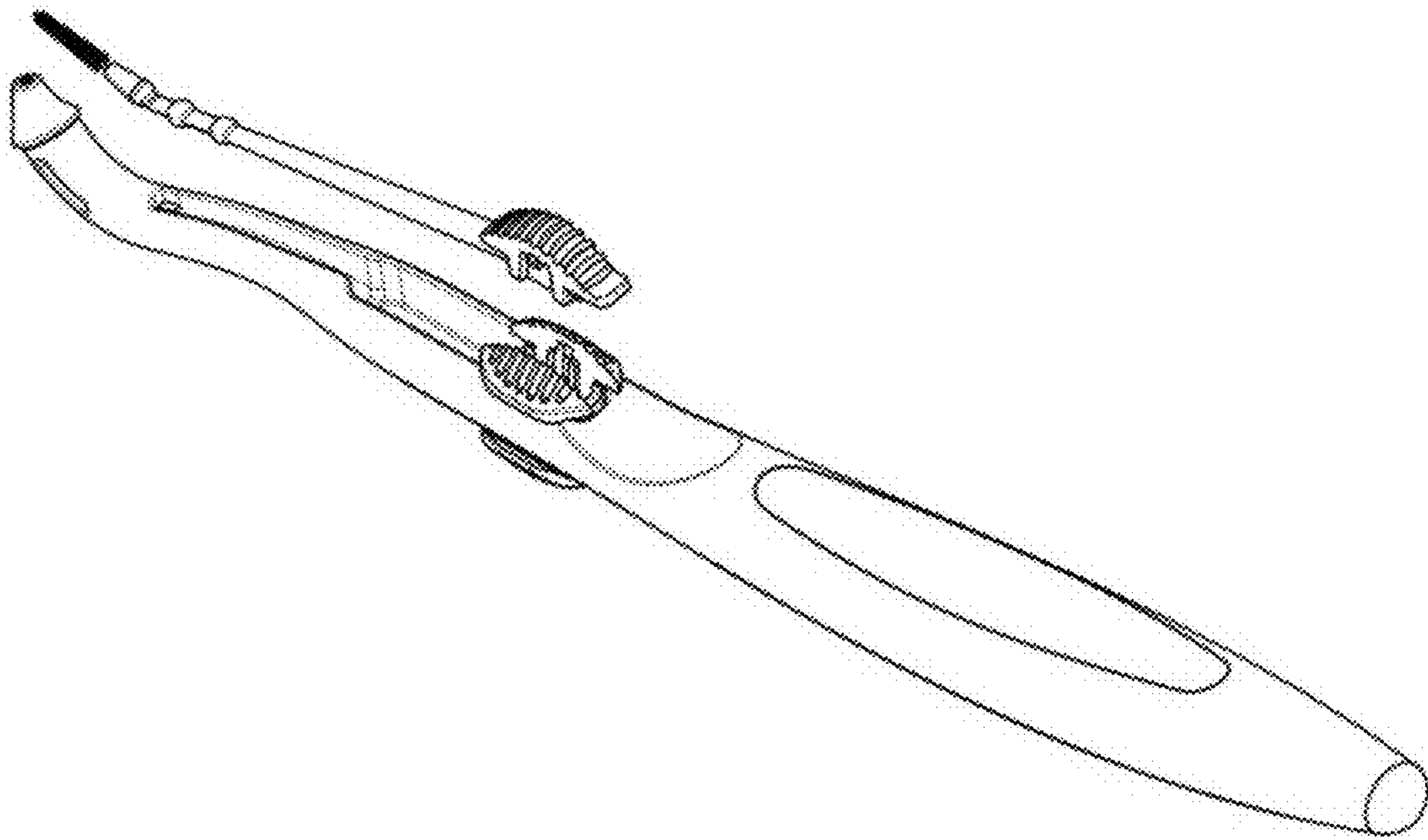

1.2

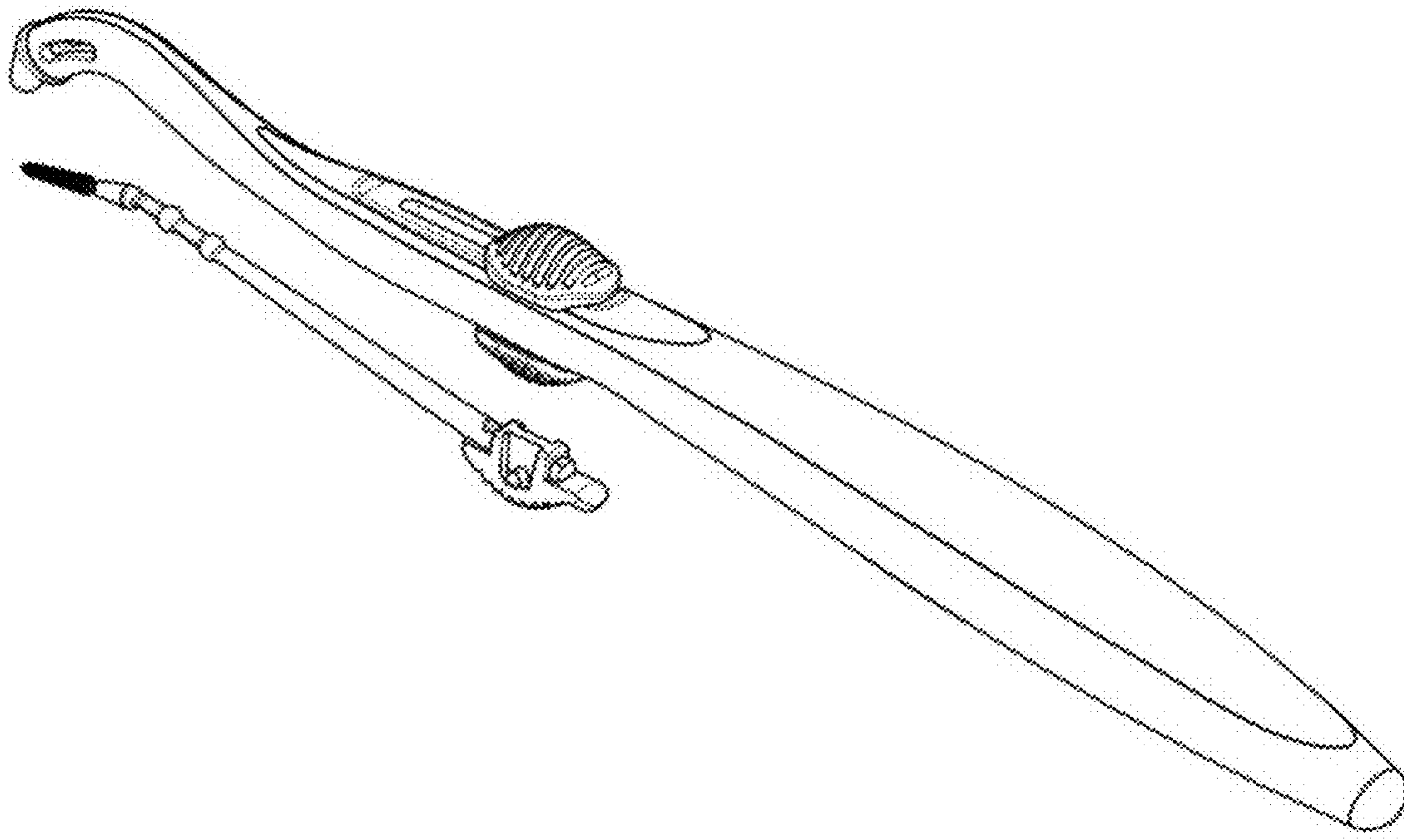

1.3

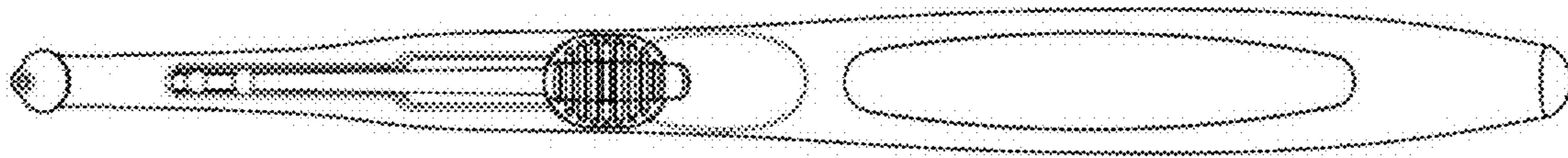

1.4

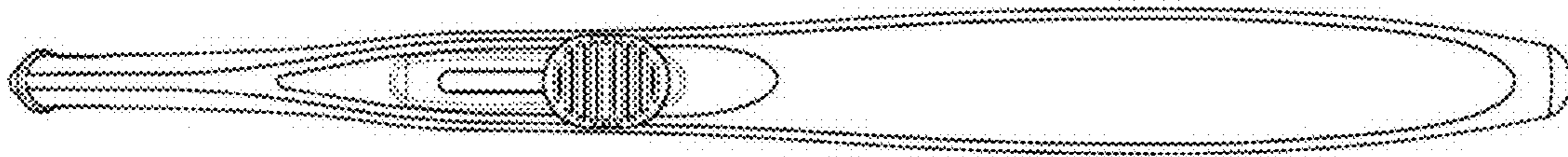

1.5

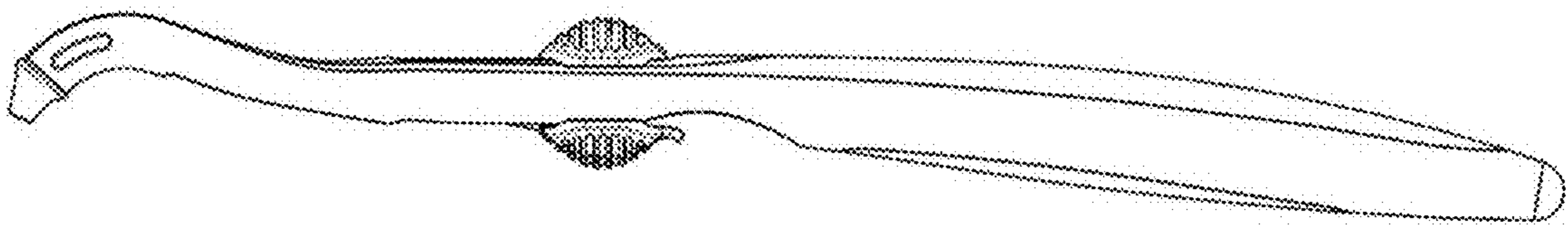

1.6

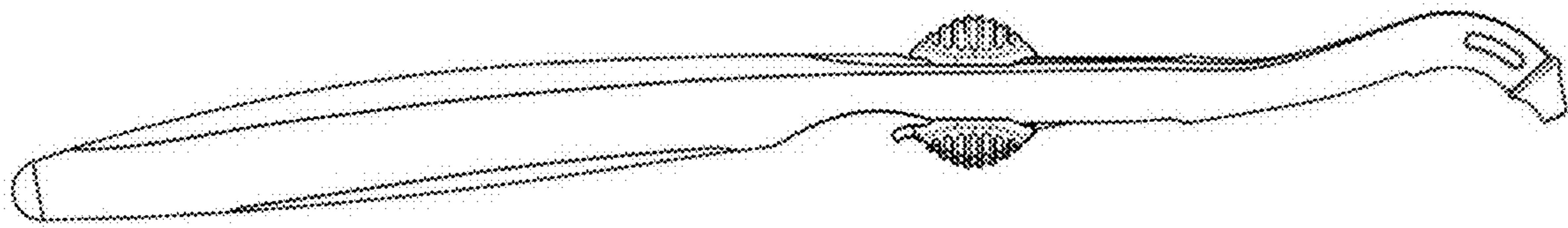

1.7

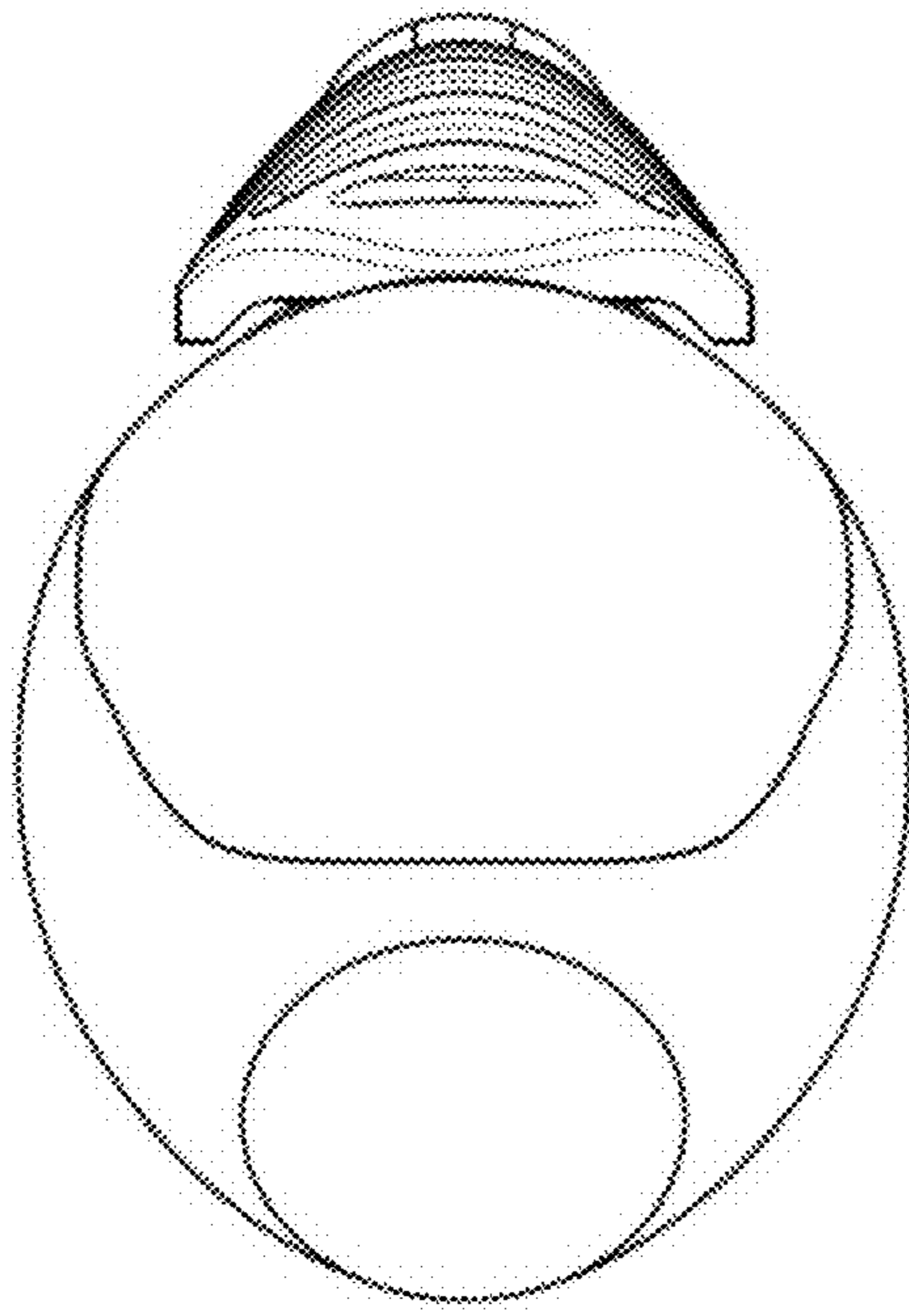

1.8

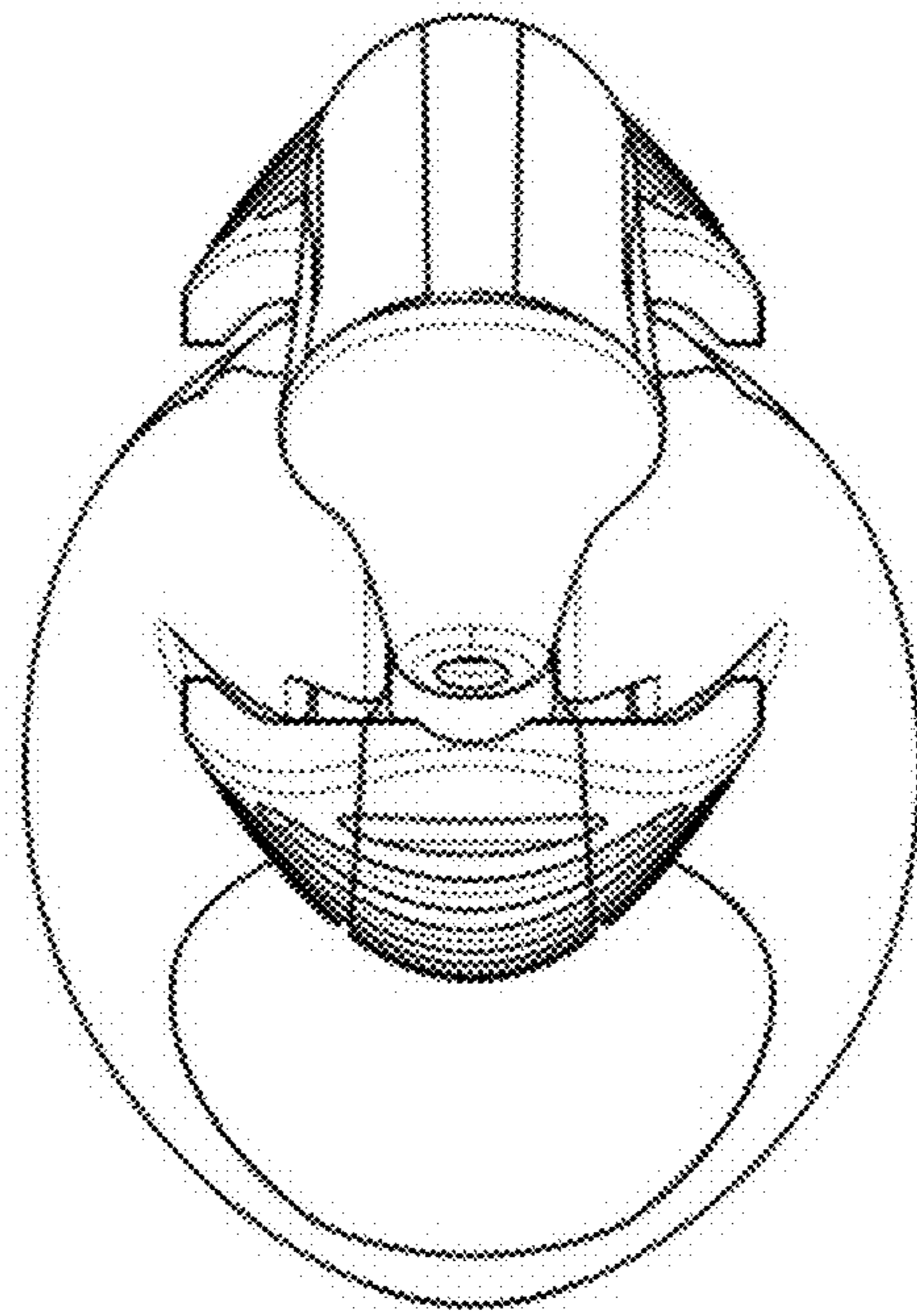

2.1

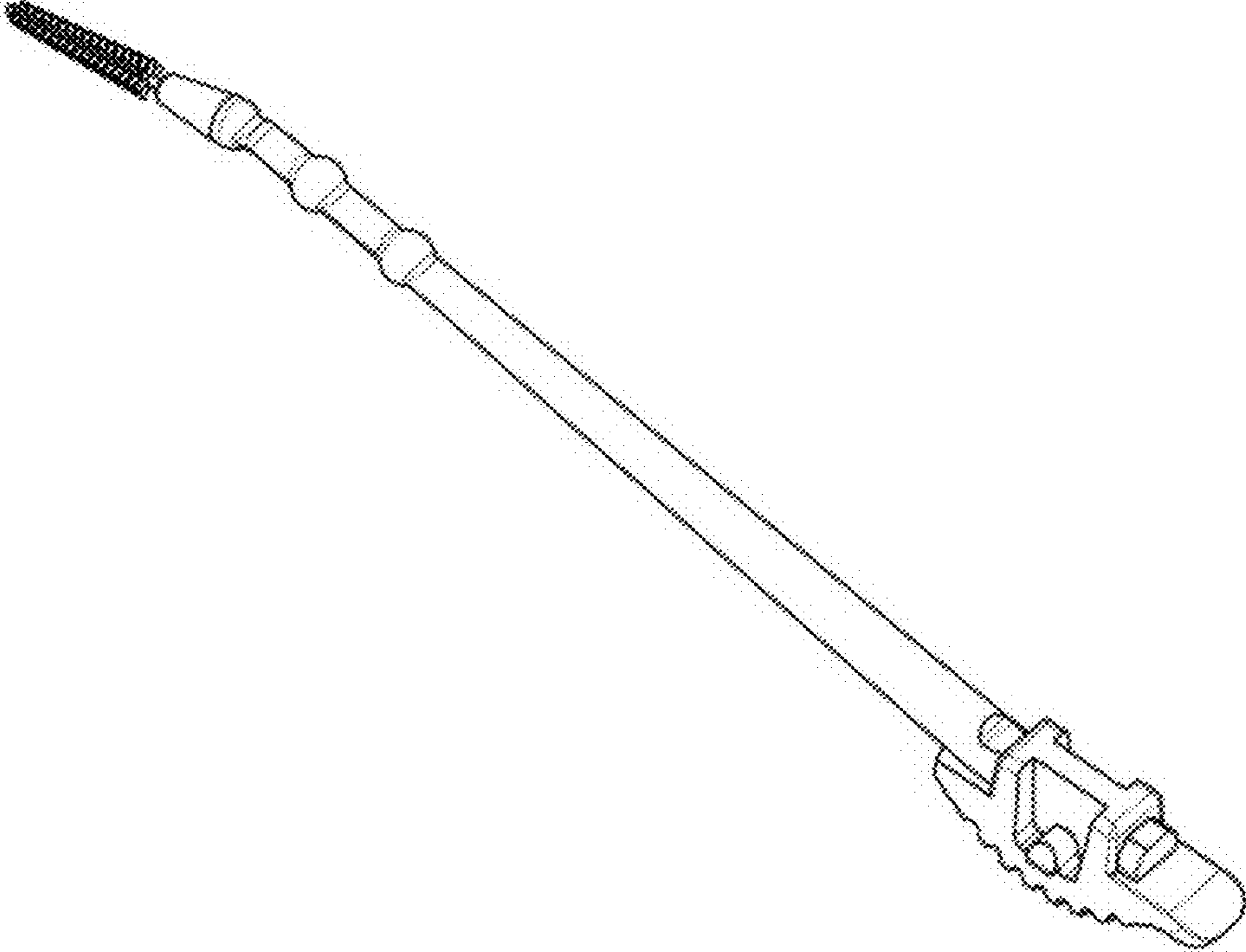

2.2

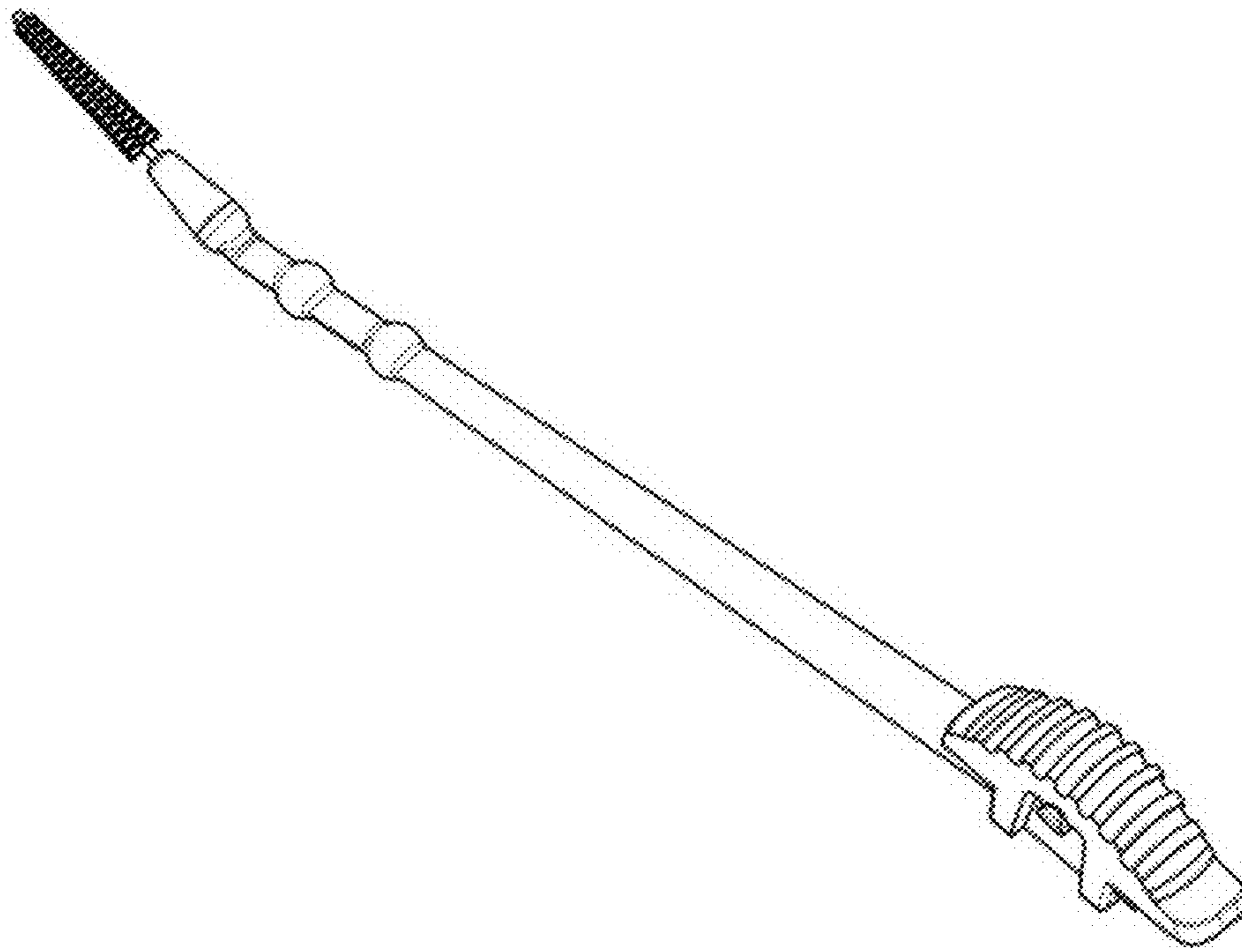

2.3

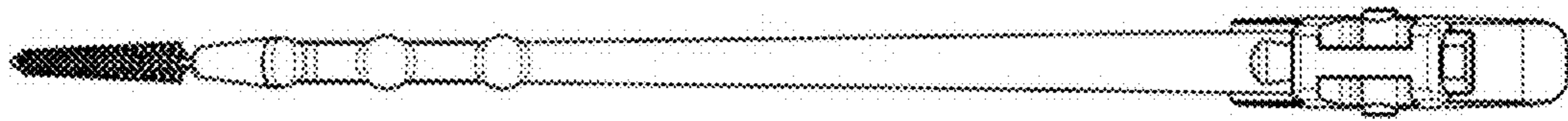

2.4

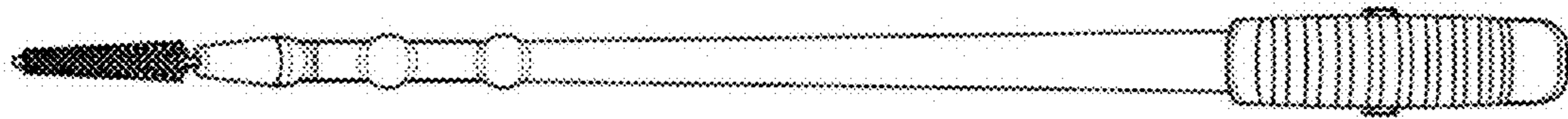

2.5

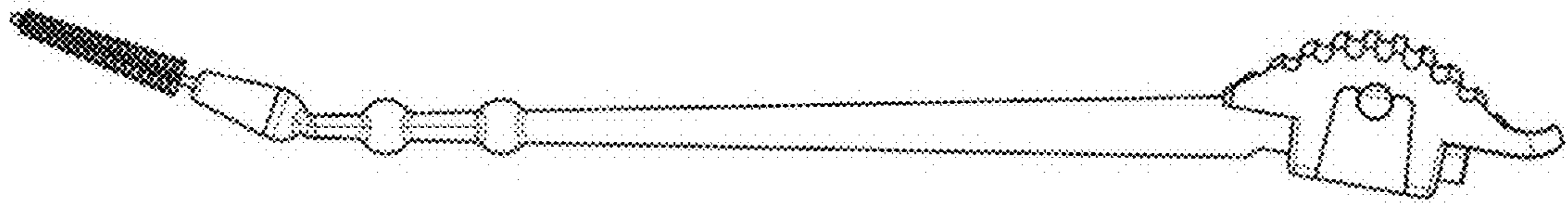

2.6

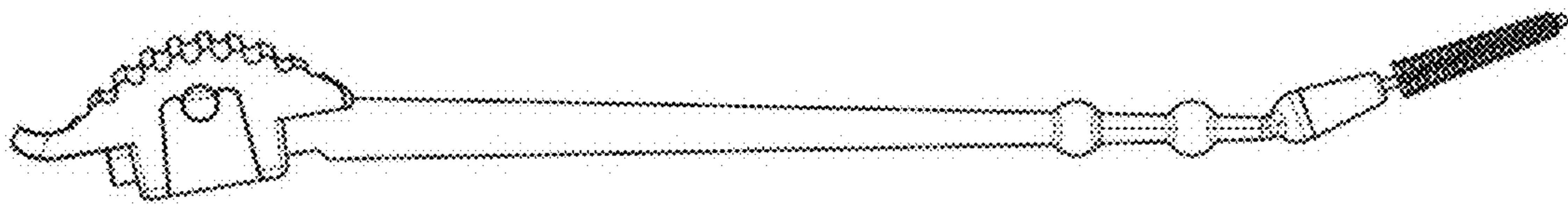

2.7

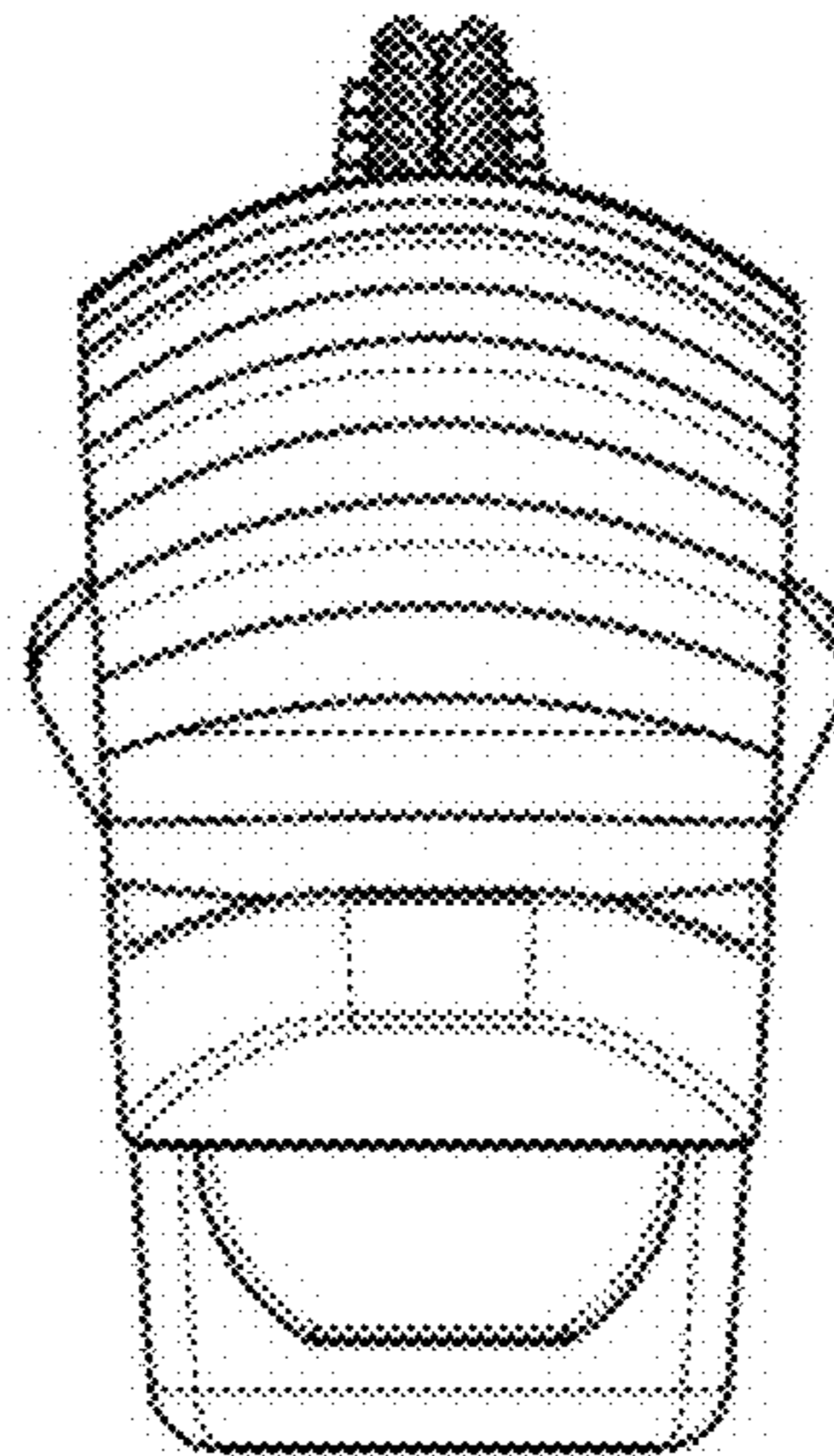

2.8

