



US00D812829S

(12) **United States Design Patent**
Shin et al.

(10) **Patent No.:** **US D812,829 S**
(45) **Date of Patent:** **** Mar. 13, 2018**

(54) **CLOTHES CLEANING MACHINE**
(71) Applicant: **LG ELECTRONICS INC.**, Seoul (KR)
(72) Inventors: **Daekee Shin**, Seoul (KR); **Hophil Lee**, Seoul (KR); **Jaewon Jeong**, Seoul (KR)
(73) Assignee: **LG Electronics Inc.**, Seoul (KR)
(**) Term: **15 Years**
(21) Appl. No.: **35/501,434**
(22) Filed: **Feb. 26, 2016**
(80) **Hague Agreement Data**
Int. Filing Date: **Feb. 26, 2016**
Int. Reg. No.: **DM/090455**
Int. Reg. Date: **Feb. 26, 2016**
Int. Reg. Pub. Date: **Aug. 26, 2016**

(30) **Foreign Application Priority Data**
Sep. 15, 2015 (KR) 30-2015-0046975
(51) **LOC (11) Cl.** **15-05**
(52) **U.S. Cl.**
USPC **D32/25**
CPC **D06F 33/02 (2013.01)**
(58) **Field of Classification Search**
USPC D32/1-8, 25-29
CPC D06F 33/02; D06F 39/02; D06F 2204/065;
D06F 25/00; D06F 35/006
See application file for complete search history.

(56) **References Cited**
U.S. PATENT DOCUMENTS
2,578,549 A * 12/1951 Hooban A46B 13/02
15/182
* cited by examiner
Primary Examiner — Richard E Chilcot
(74) *Attorney, Agent, or Firm* — Birch, Stewart, Kolasch & Birch, LLP

(57) **CLAIM**
The ornamental design for a clothes cleaning machine, as shown and described.

DESCRIPTION
1. Clothes cleaning machine
1.1 is a perspective view of a clothes cleaning machine showing our new design;
1.2 is a front elevation view thereof;
1.3 is a rear elevation view thereof;
1.4 is a left-side elevation view thereof;
1.5 is a right-side elevation view thereof;
1.6 is a top plan view thereof;
1.7 is a bottom plan view thereof;
1.8 is another perspective view thereof in a use condition; and
1.9 is another perspective view thereof in another use condition.
The broken lines in Figures 1.8 and 1.9 are included for the purpose of illustrating environmental structure and form no part of the claimed design.

1 Claim, 9 Drawing Sheets

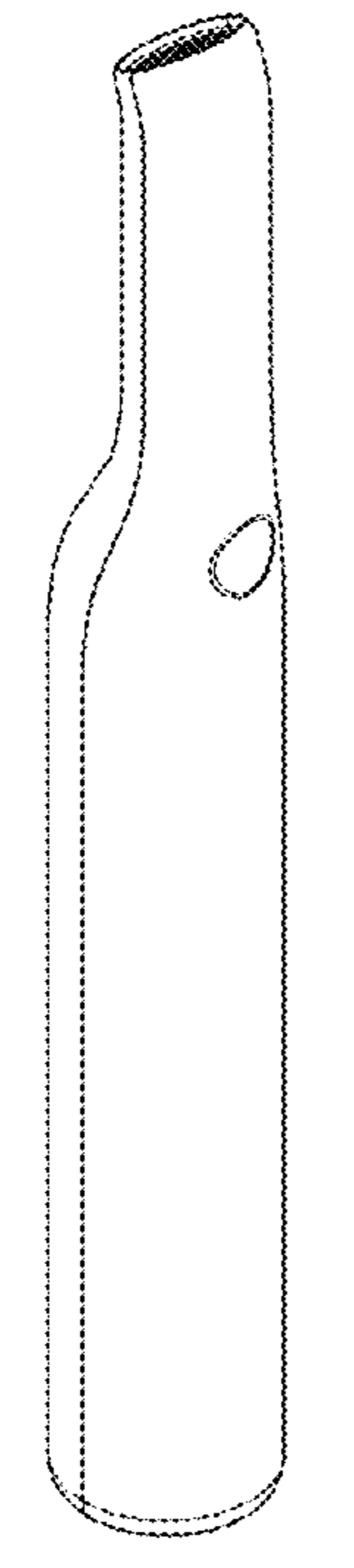

1.1

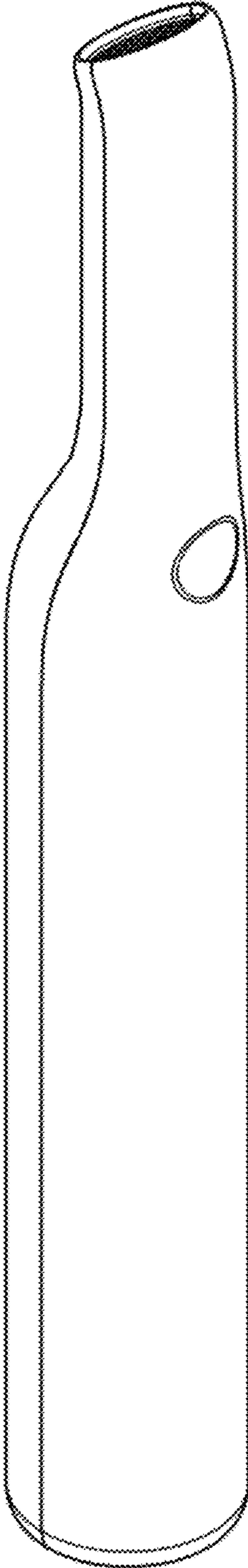

1.2

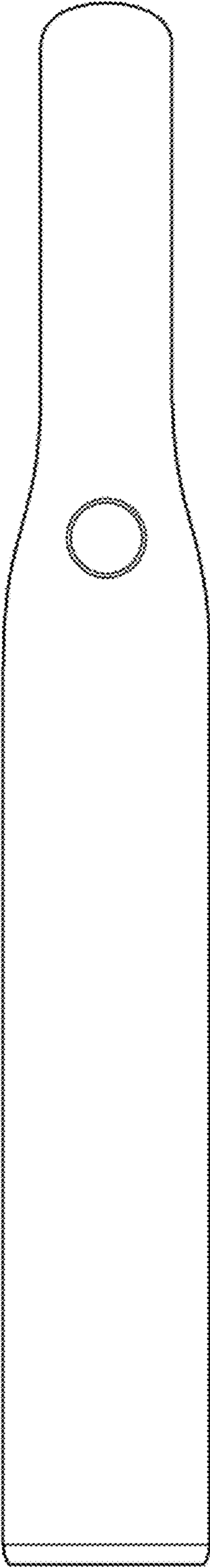

1.3

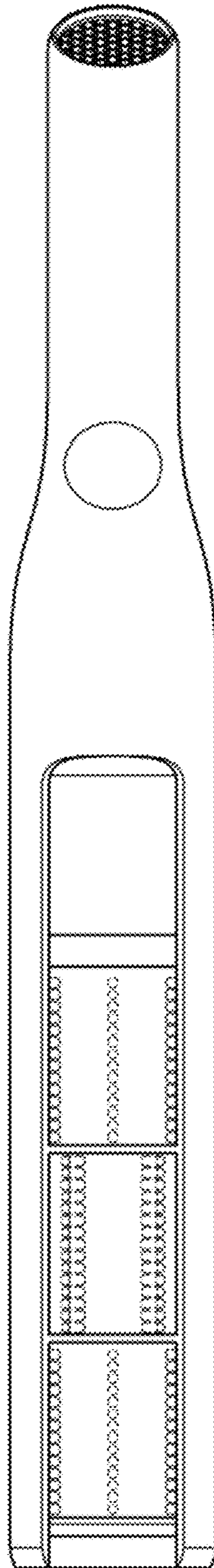

1.4

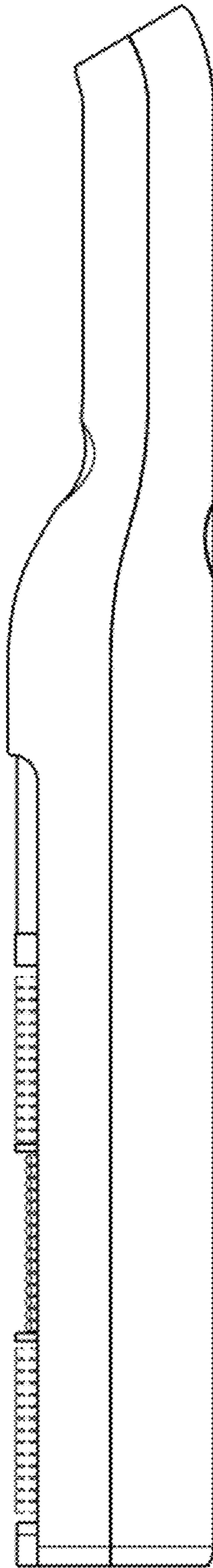

1.5

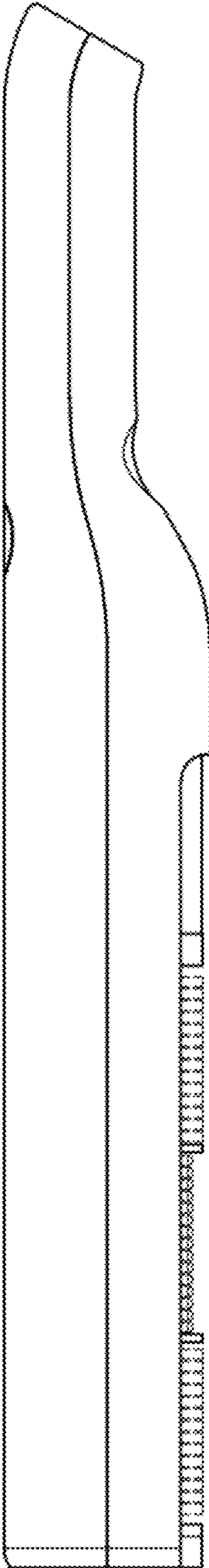

1.6

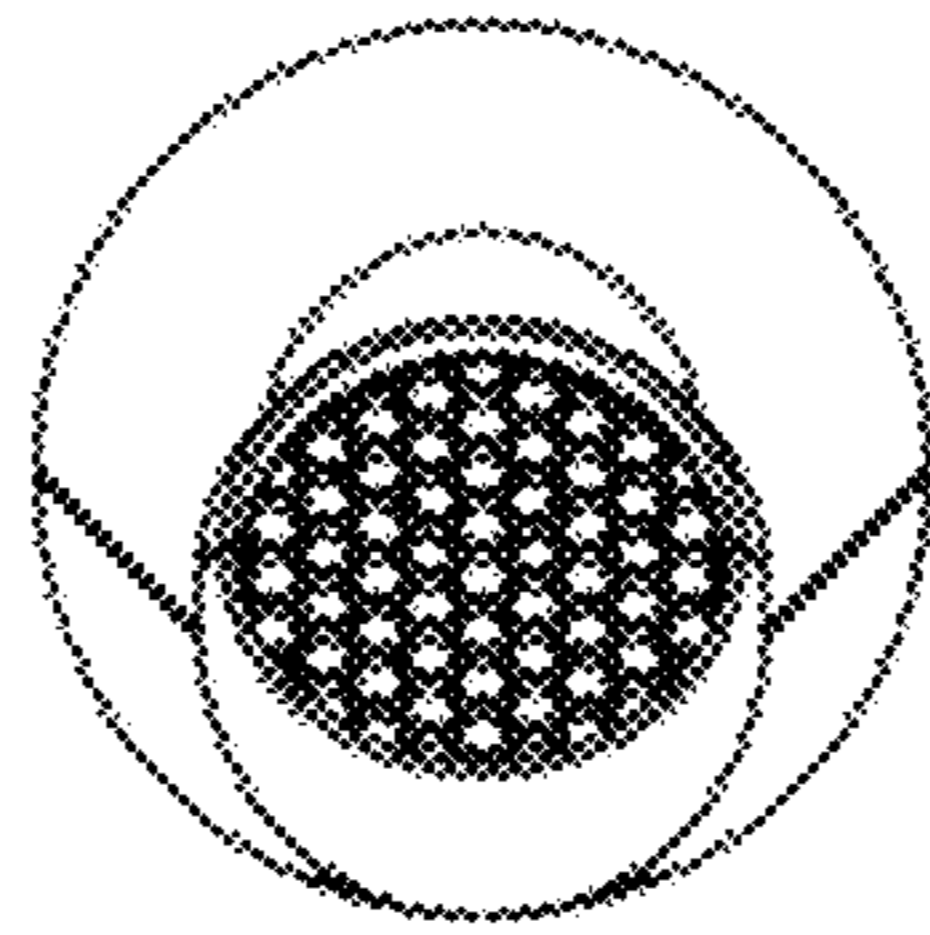

1.7

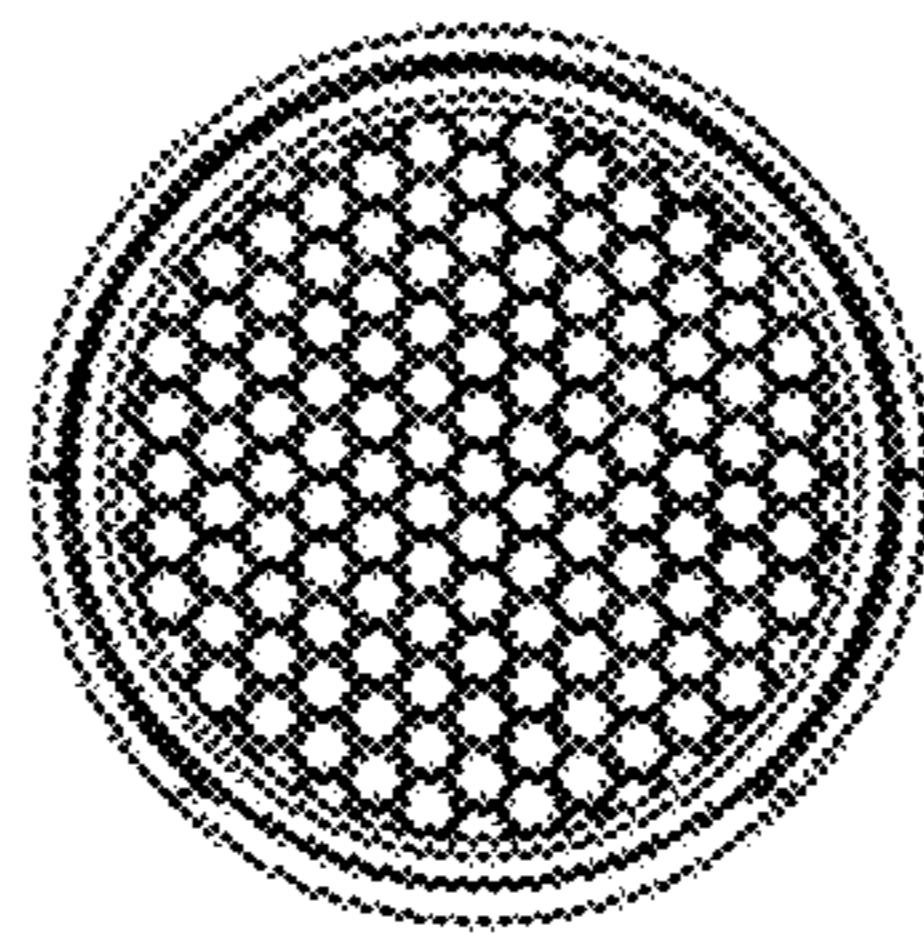

1.8

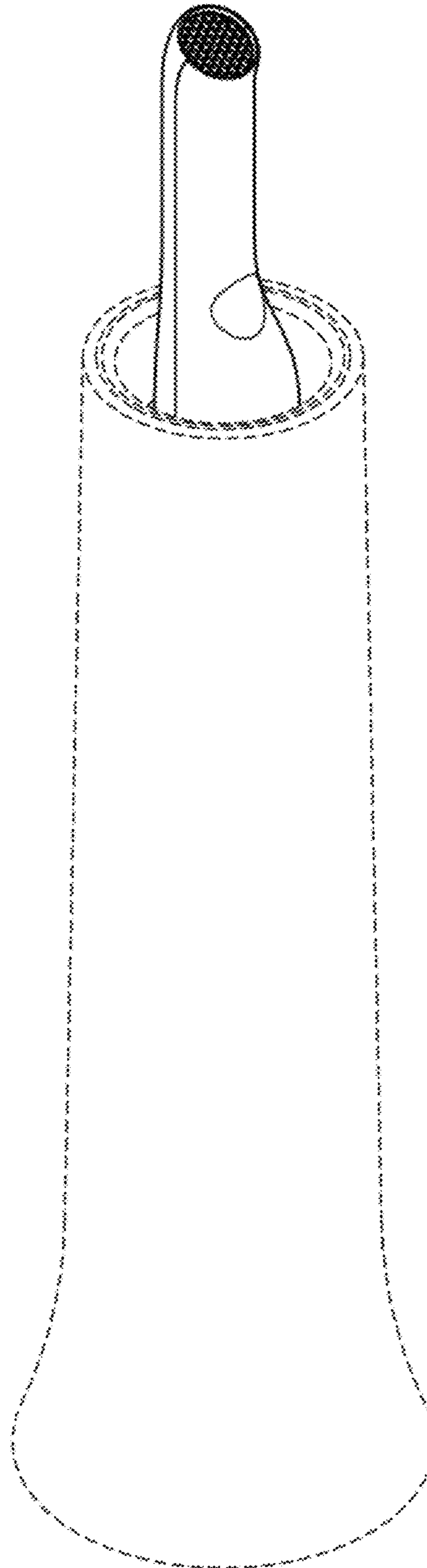

1.9

