



US00D812813S

(12) **United States Design Patent** (10) **Patent No.:** **US D812,813 S**
Stephenson (45) **Date of Patent:** **** Mar. 13, 2018**

(54) **BRASS KNUCKLES COMB**
(71) Applicant: **Zachary Daniel Stephenson**, Orlando, FL (US)
(72) Inventor: **Zachary Daniel Stephenson**, Orlando, FL (US)
(**) Term: **15 Years**
(21) Appl. No.: **29/593,689**
(22) Filed: **Feb. 10, 2017**
(51) **LOC (11) Cl.** **28-03**
(52) **U.S. Cl.**
USPC **D28/22**
(58) **Field of Classification Search**
USPC D28/22, 21, 10, 25, 27, 30, 31, 34;
D30/159; 132/219, 212, 146, 149, 159
See application file for complete search history.

D468,863 S * 1/2003 Irving D28/21
D495,089 S * 8/2004 Tomaro D28/21
D496,755 S * 9/2004 Jackson D28/22
D561,393 S * 2/2008 Burchakchi D28/21
D644,376 S * 8/2011 Morrill D28/21
D646,434 S * 10/2011 Libman D28/33
D651,205 S * 12/2011 Soekoro D14/250
D748,835 S * 2/2016 Yu D26/39
D770,093 S * 10/2016 Smith D28/21
D774,992 S * 12/2016 Hill D12/127
D776,024 S * 1/2017 Jordan D12/179
D791,410 S * 7/2017 Whittaker D28/54

* cited by examiner

Primary Examiner — Susan Bennett Hattan

Assistant Examiner — Rebecca Tsehaye

(57) **CLAIM**

The ornamental design for a brass knuckles comb, as shown and described.

DESCRIPTION

FIG. 1 is a top perspective view of a brass knuckles comb showing my new design;
FIG. 2 is a right bottom perspective view of thereof;
FIG. 3 is a left bottom perspective view thereof;
FIG. 4 is a front view thereof;
FIG. 5 is a back view thereof;
FIG. 6 is a top view thereof;
FIG. 7 is a bottom view thereof;
FIG. 8 is a right view thereof; and,
FIG. 9 is a left view thereof.

1 Claim, 9 Drawing Sheets

(56) **References Cited**

U.S. PATENT DOCUMENTS

D224,847 S * 9/1972 Thomas D28/10
D259,667 S * 6/1981 Williams D28/22
D332,505 S * 1/1993 Ward D28/21
D358,000 S * 5/1995 Molenaar D28/22
D367,544 S * 2/1996 Bozak D28/31
D420,170 S * 2/2000 Chen D28/22
D434,183 S * 11/2000 Fraenkel D28/22
D441,136 S * 4/2001 Leman D28/31
D457,267 S * 5/2002 Levandovsky D28/31

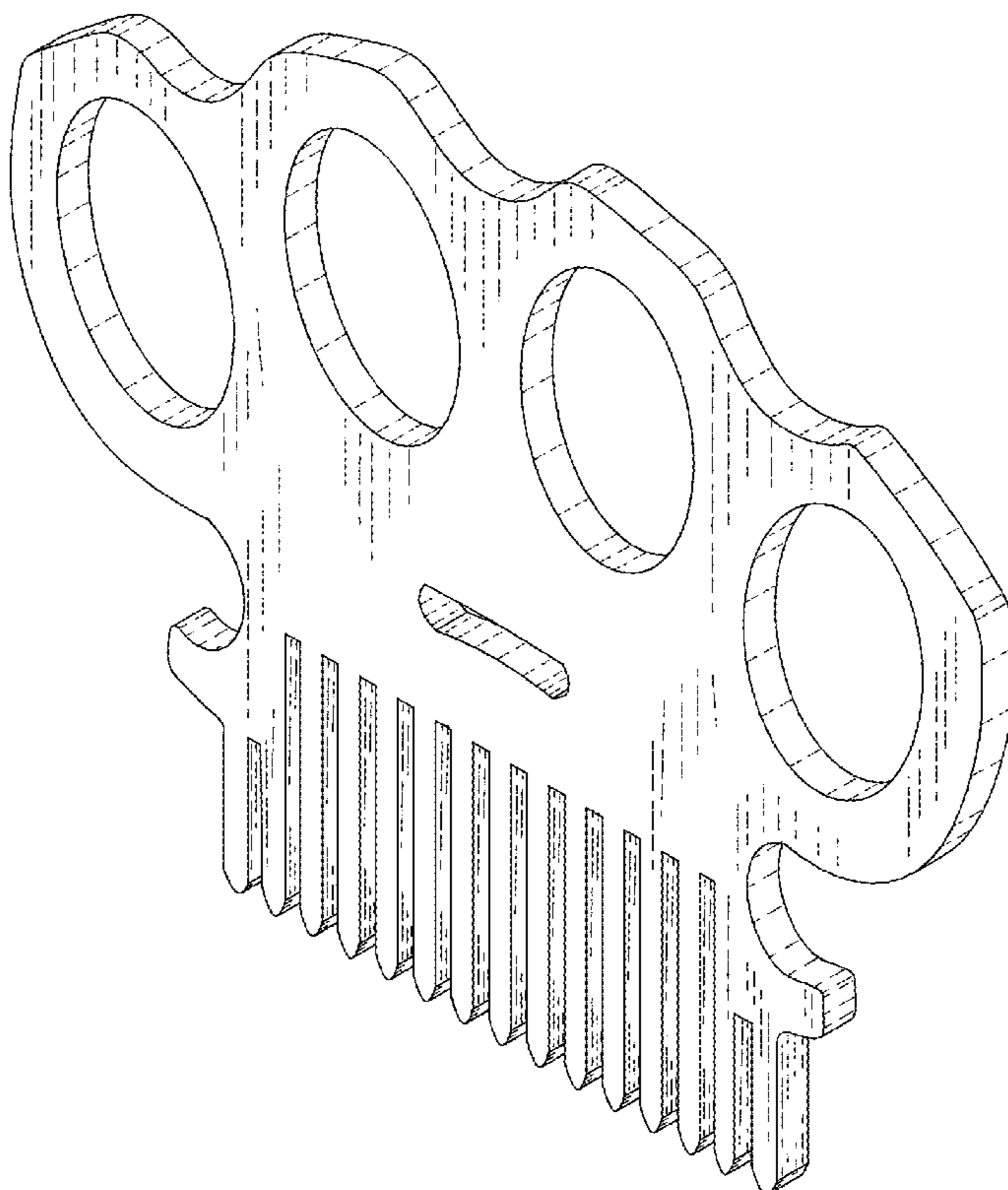

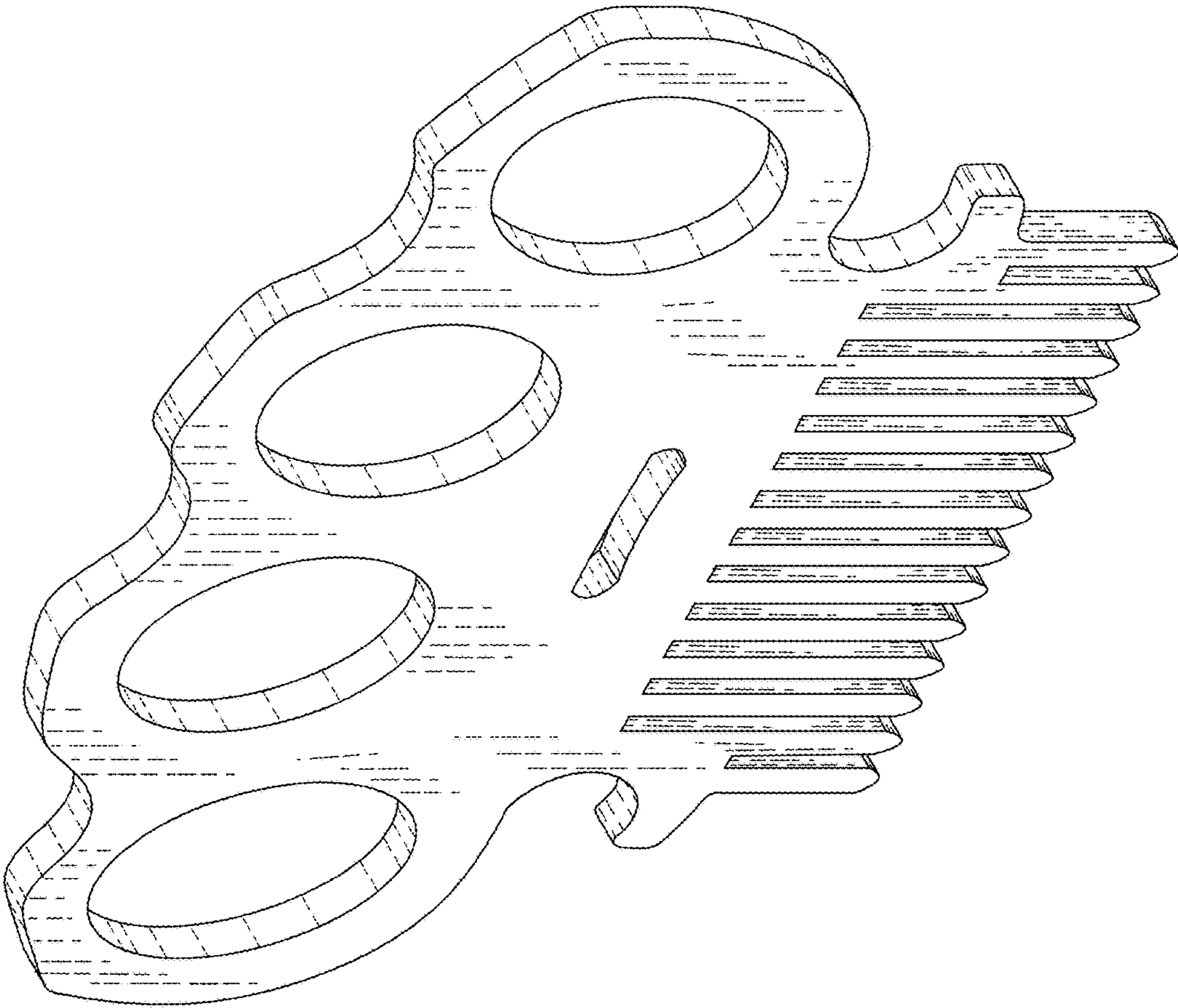

FIG. 1

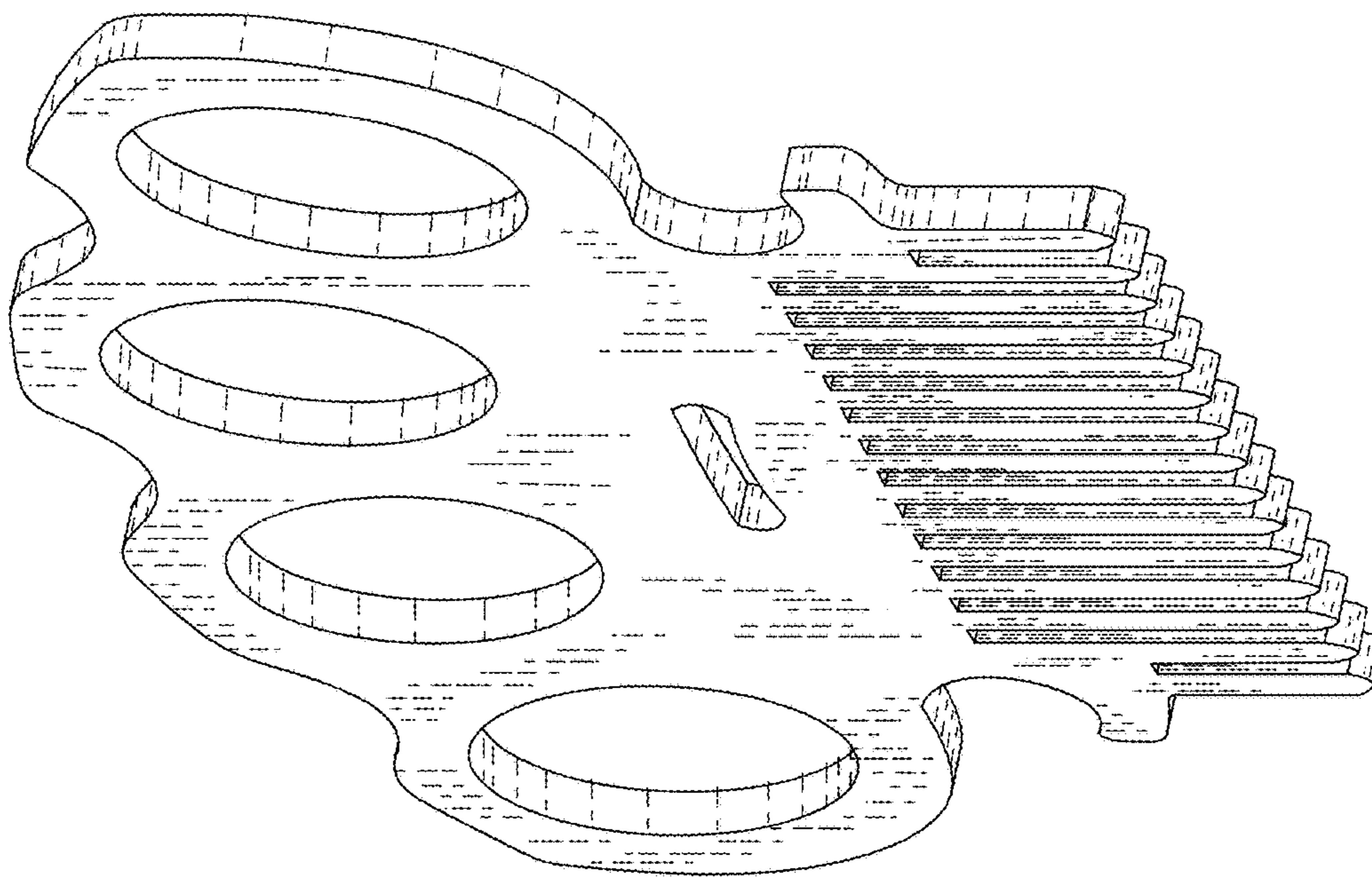

FIG. 2

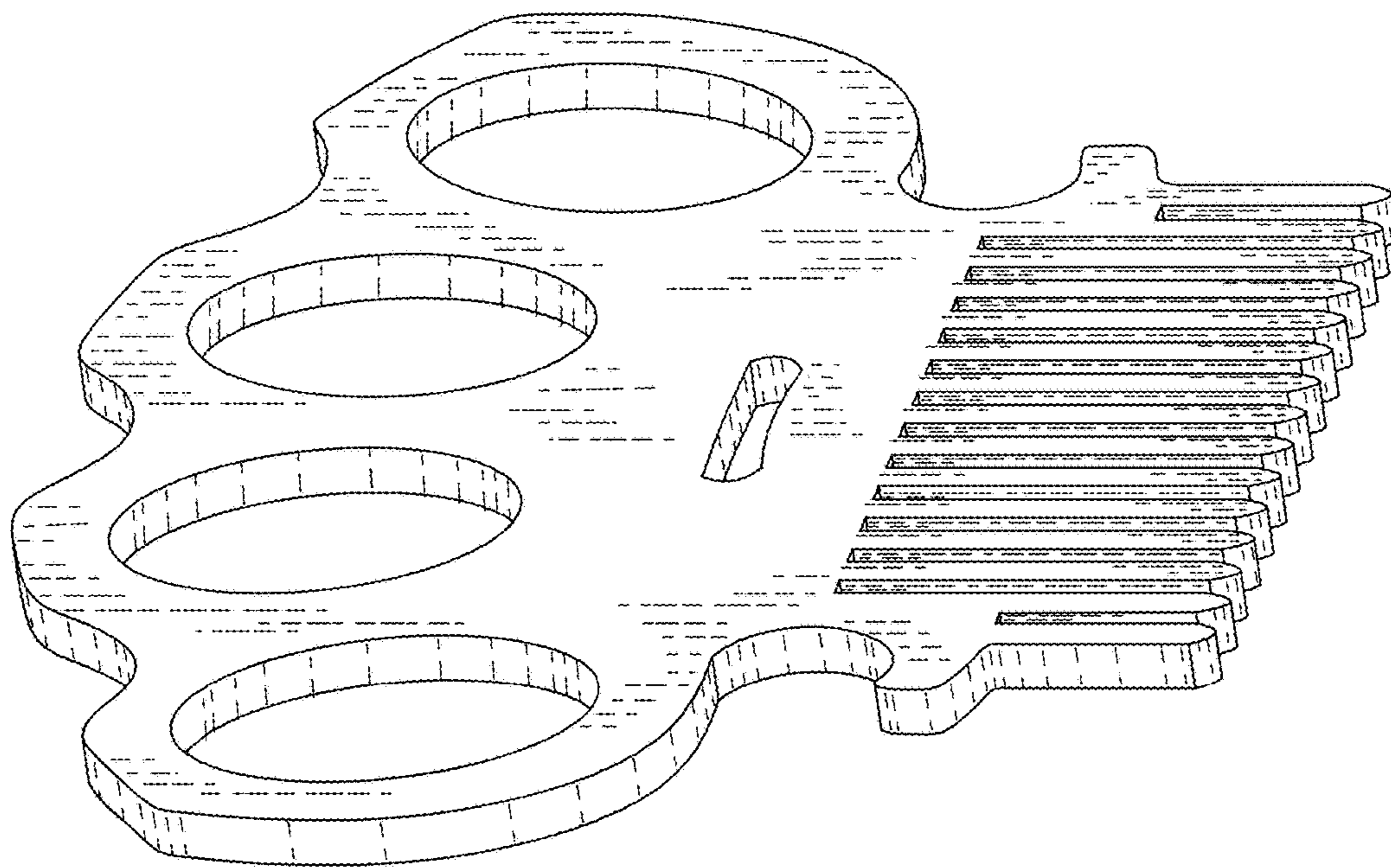

FIG. 3

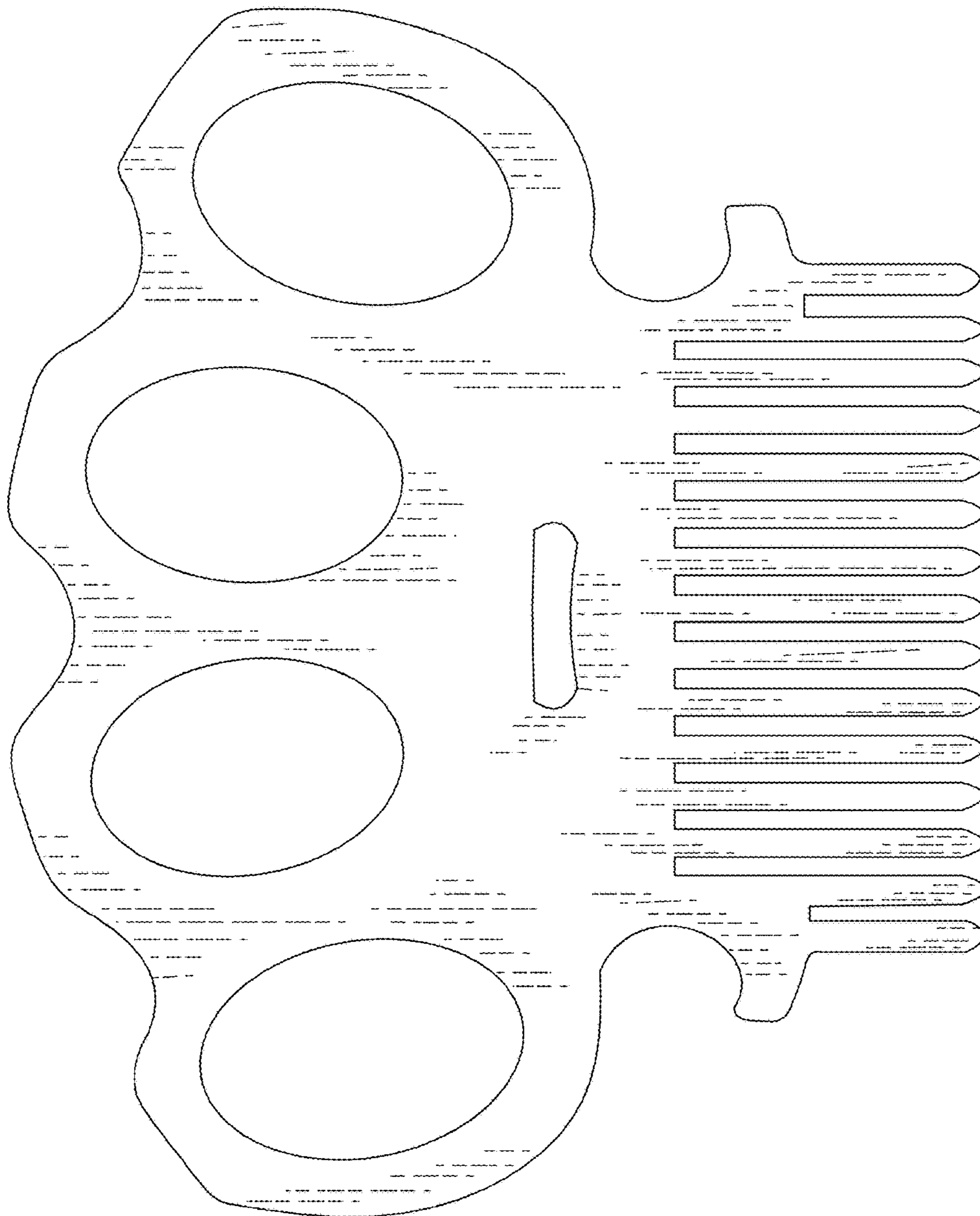

FIG. 4

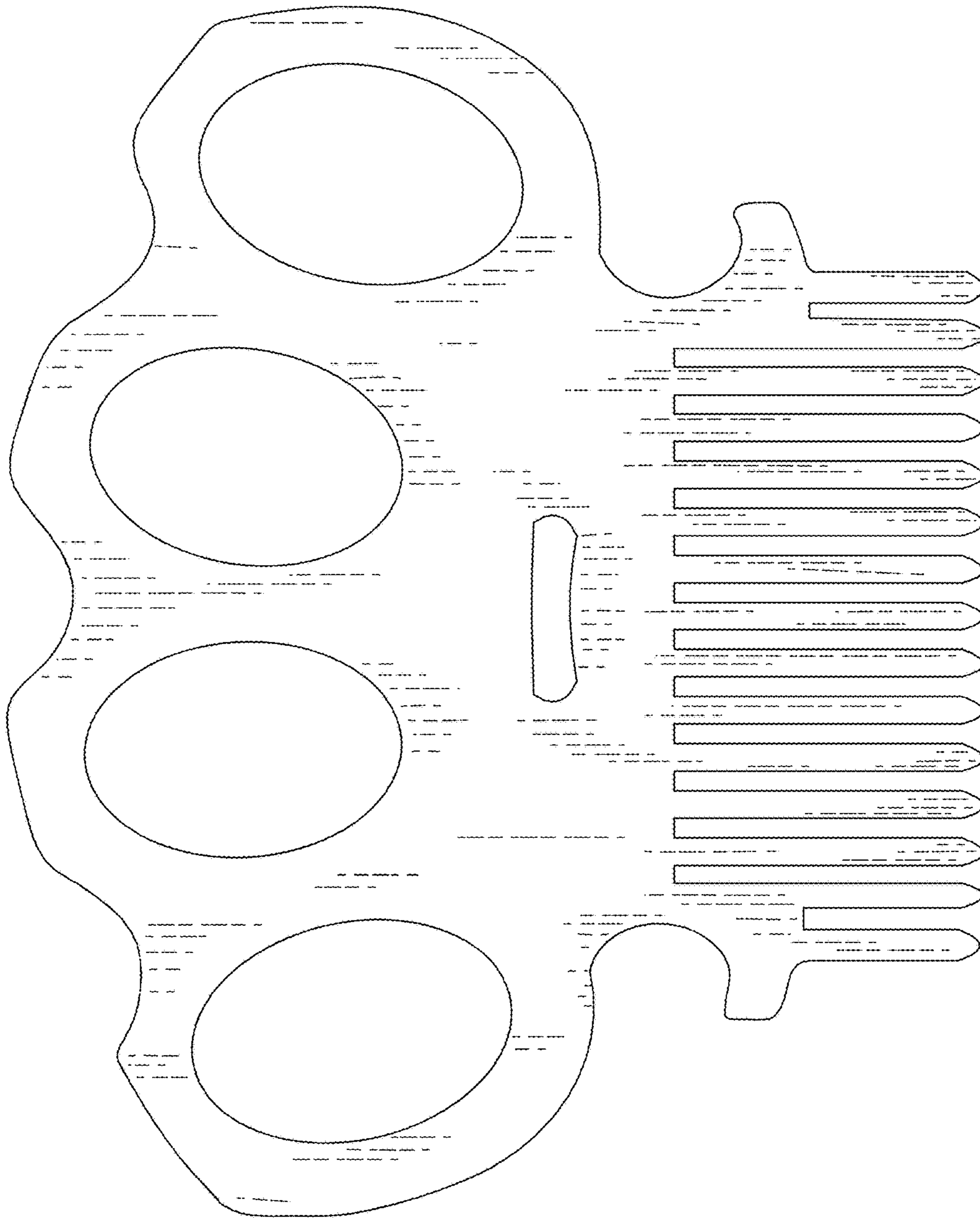

FIG. 5

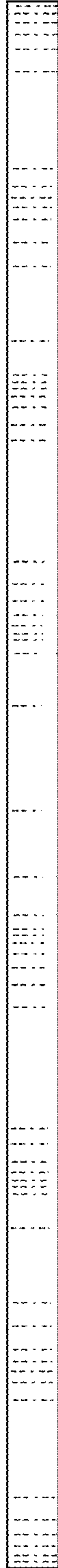

FIG. 6



FIG. 7

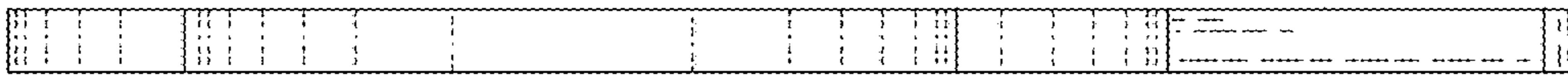

FIG. 8

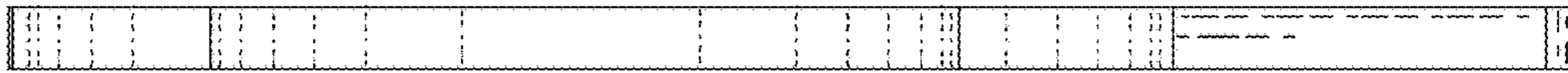

FIG. 9