



US00D812791S

(12) **United States Design Patent**  
**Wu**

(10) **Patent No.:** **US D812,791 S**  
(45) **Date of Patent:** **\*\* Mar. 13, 2018**

- (54) **VEHICLE LIGHT**
- (71) Applicant: **COPLUS INC.**, Tainan (TW)
- (72) Inventor: **Po-Hua Wu**, Tainan (TW)
- (73) Assignee: **Coplus Inc.**, Tainan (TW)
- (\*\*) Term: **15 Years**
- (21) Appl. No.: **29/596,026**
- (22) Filed: **Mar. 3, 2017**
- (51) **LOC (11) Cl.** ..... **26-07**
- (52) **U.S. Cl.**  
USPC ..... **D26/28**
- (58) **Field of Classification Search**  
USPC ..... D26/28-36; 362/459-468, 475-478,  
362/485-487  
CPC ..... F21S 48/00; F21S 48/10; F21S 48/115;  
F21S 48/225; F21S 48/1233; F21S  
48/1266; F21S 48/1388; F21S 48/2268;  
F21V 21/04  
See application file for complete search history.

- D787,727 S \* 5/2017 Lai ..... D26/28
- D791,985 S \* 7/2017 Lin ..... D26/28
- D792,994 S \* 7/2017 Hwang ..... D26/28
- D794,851 S \* 8/2017 Youn ..... D26/28
- D794,853 S \* 8/2017 Lai ..... D26/28
- D797,324 S \* 9/2017 Lai ..... D26/28
- D798,476 S \* 9/2017 Lai ..... D26/28
- D799,728 S \* 10/2017 Whitla ..... D26/28

\* cited by examiner

*Primary Examiner* — Angela J Lee

(74) *Attorney, Agent, or Firm* — Lewis Roca Rothgerber  
Christie LLP

(57) **CLAIM**

The ornamental design for a vehicle light, as shown and described.

**DESCRIPTION**

FIG. 1 is a perspective view of the vehicle light;  
FIG. 2 is a front view thereof;  
FIG. 3 is a rear view thereof;  
FIG. 4 is a left side view thereof;  
FIG. 5 is a right side view thereof;  
FIG. 6 is a top view thereof; and,  
FIG. 7 is a bottom view thereof.

The broken lines in the drawings are for illustrative purpose only and form no part of the claimed design.

(56) **References Cited**

**U.S. PATENT DOCUMENTS**

- D761,461 S \* 7/2016 Lai ..... D26/28
- D761,463 S \* 7/2016 Lai ..... D26/28

**1 Claim, 7 Drawing Sheets**

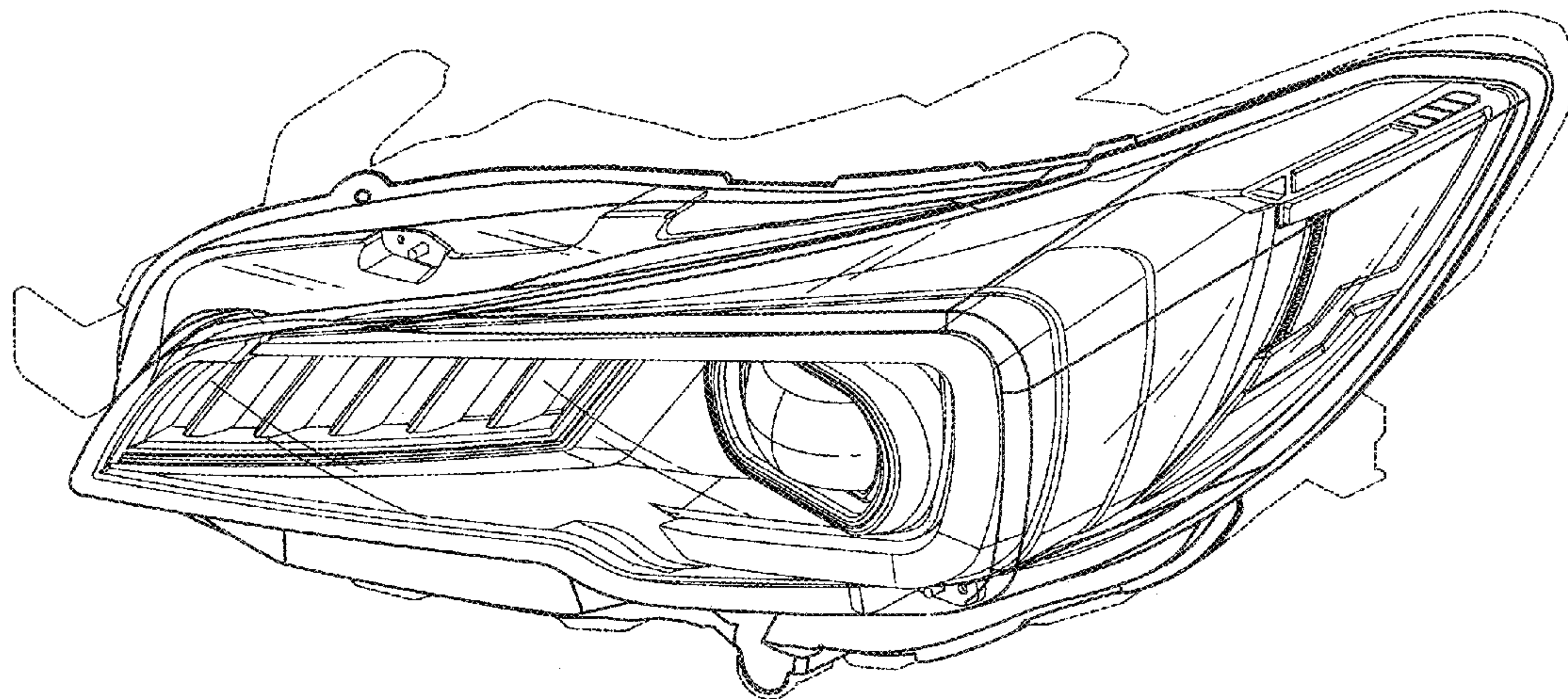

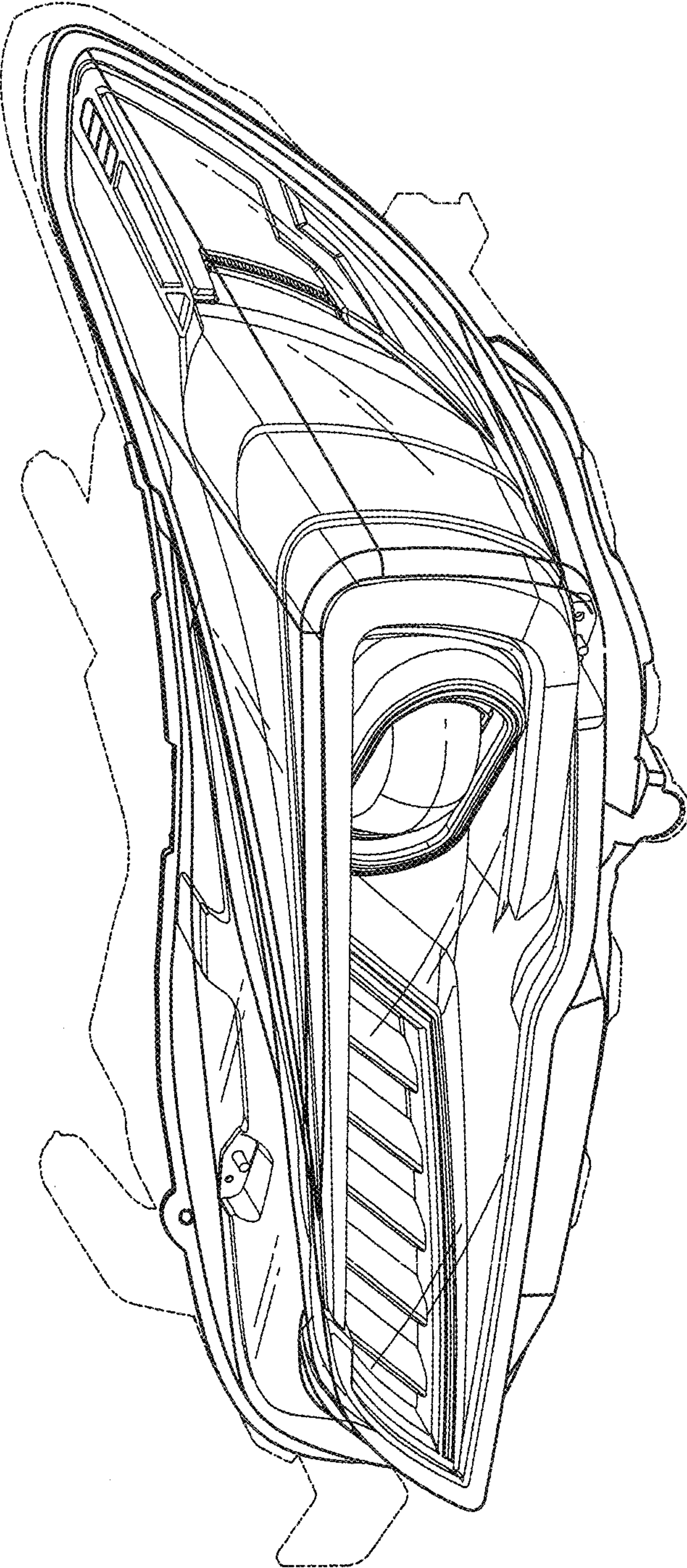

FIG. 1



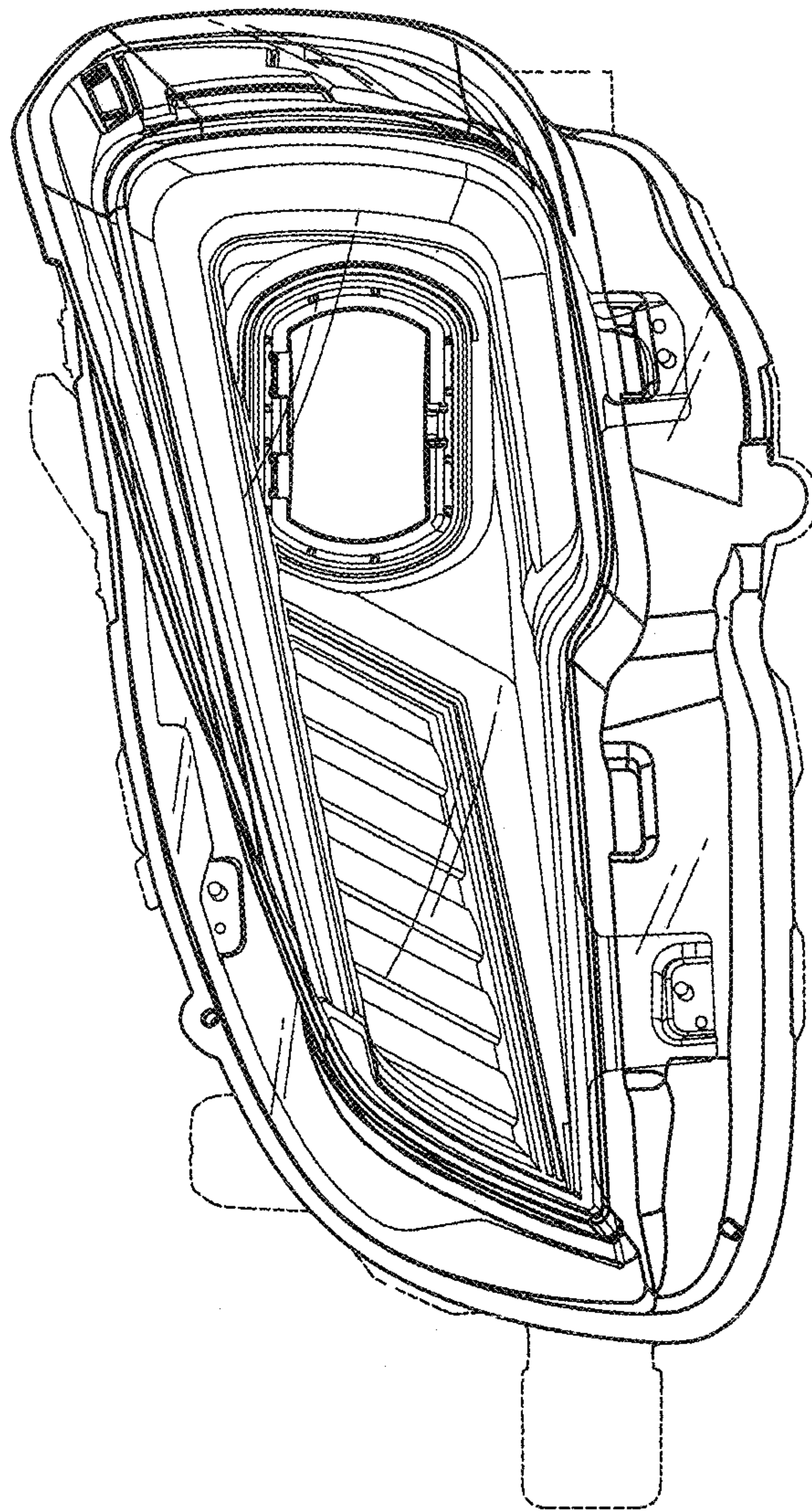

FIG. 2

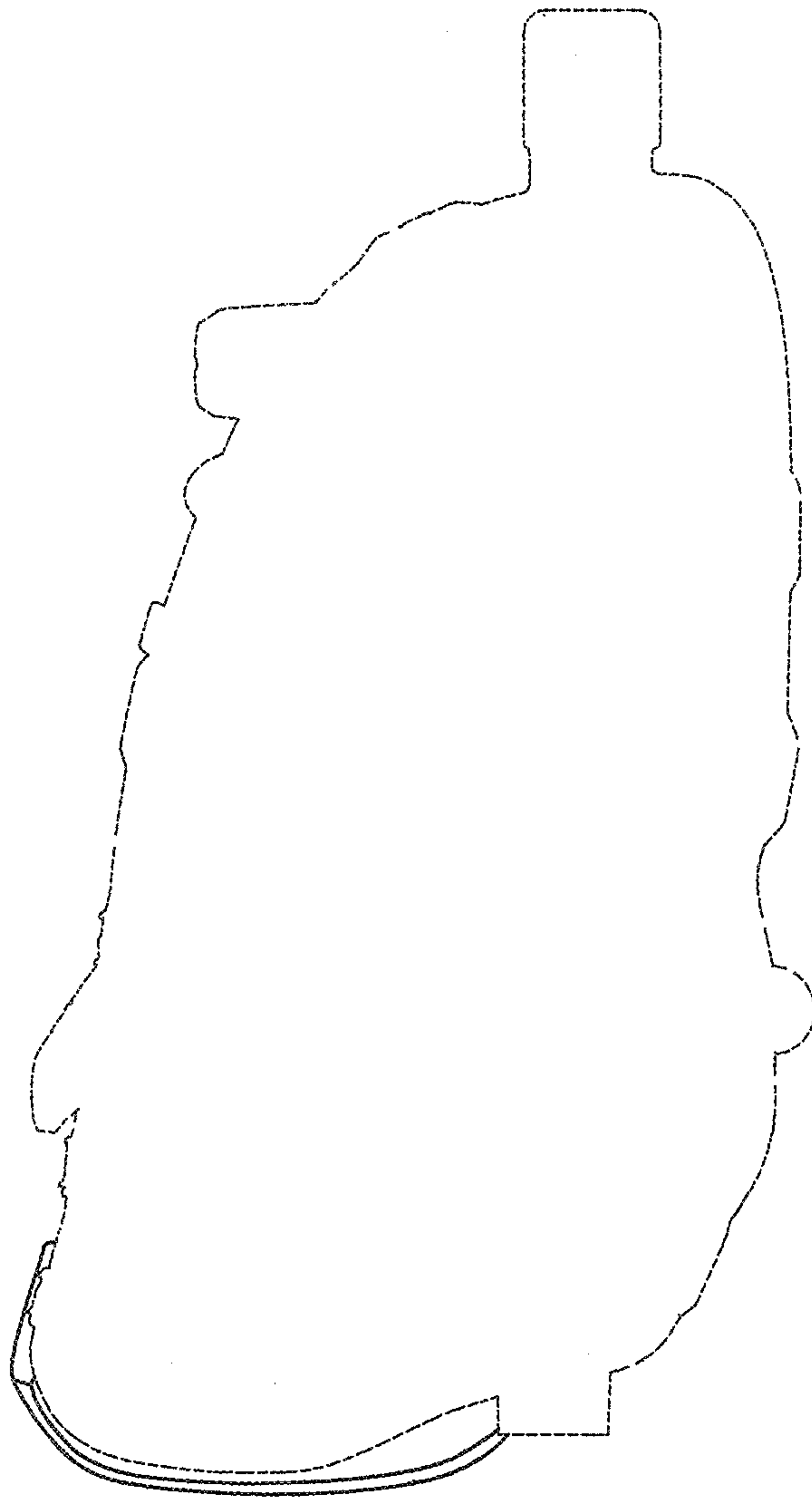

FIG. 3

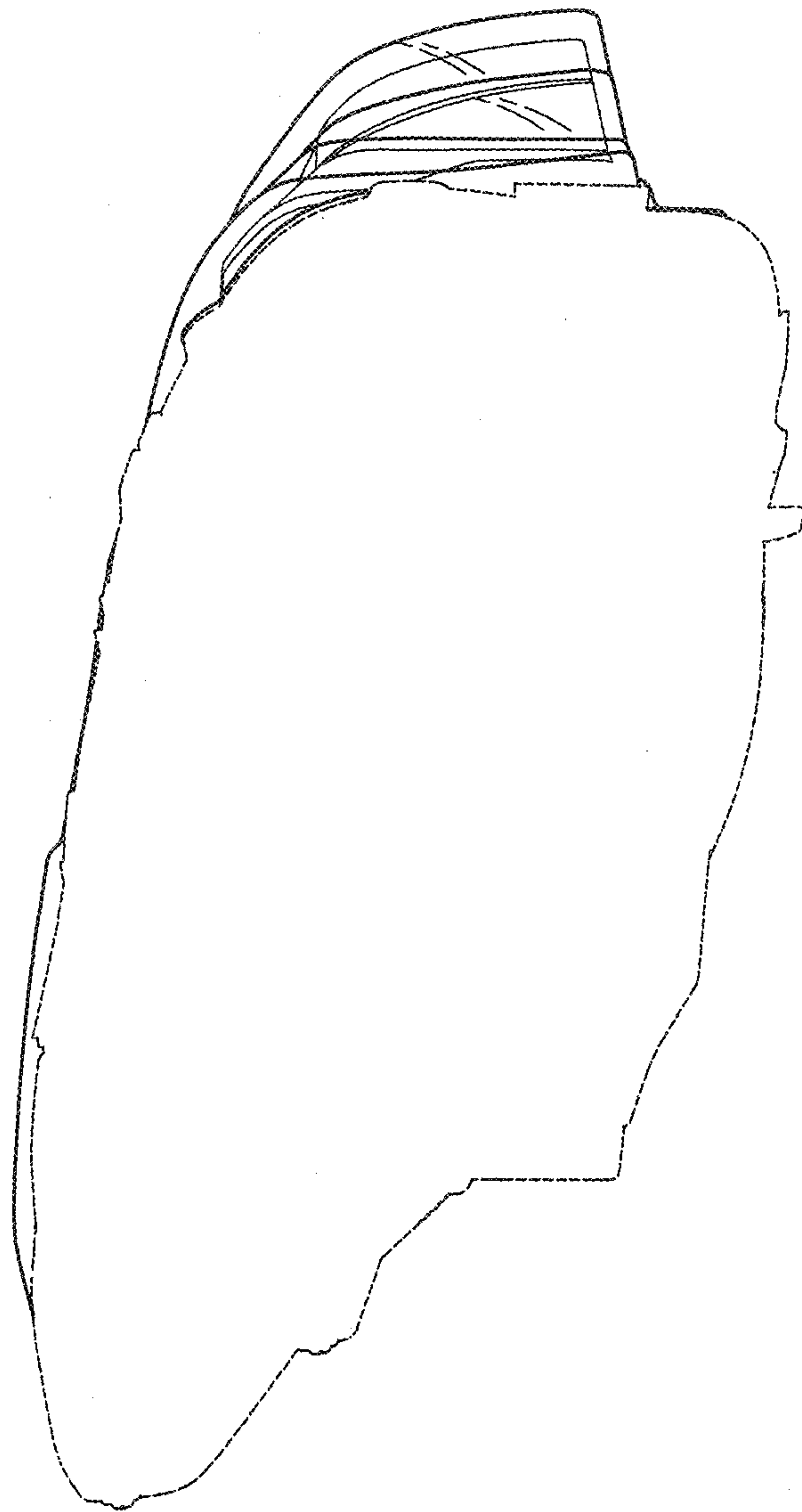

FIG. 4

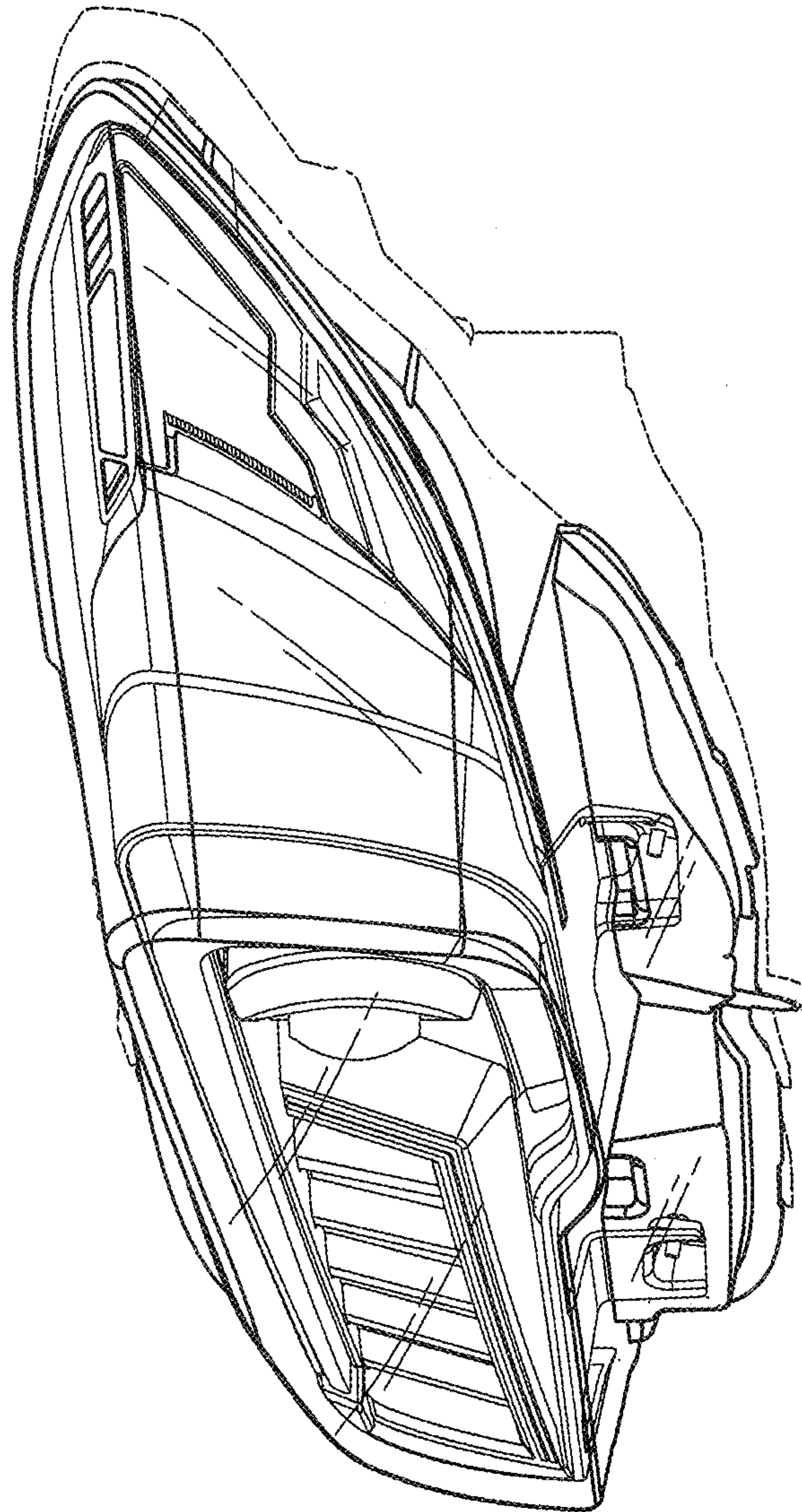

FIG. 5

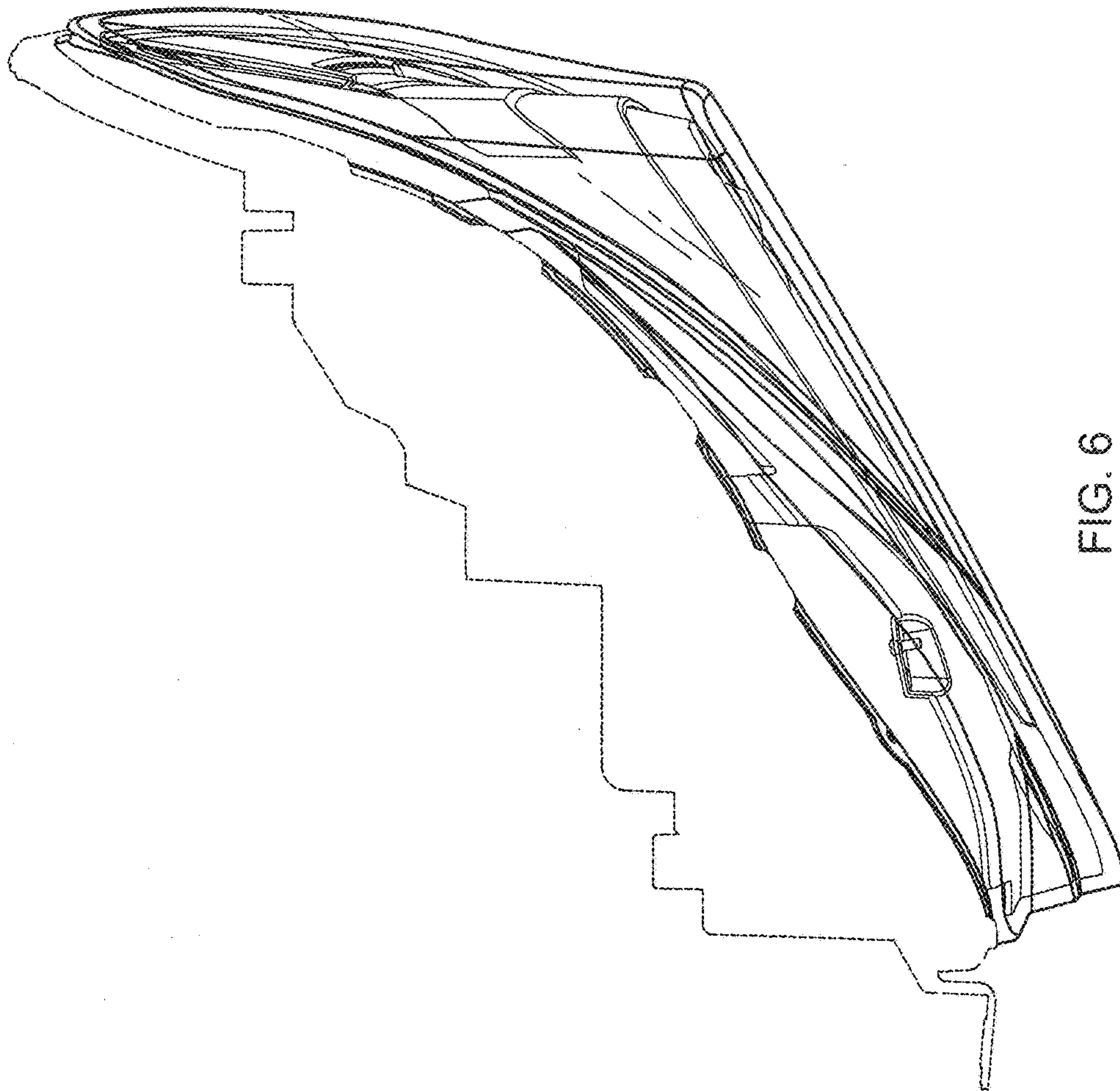

FIG. 6



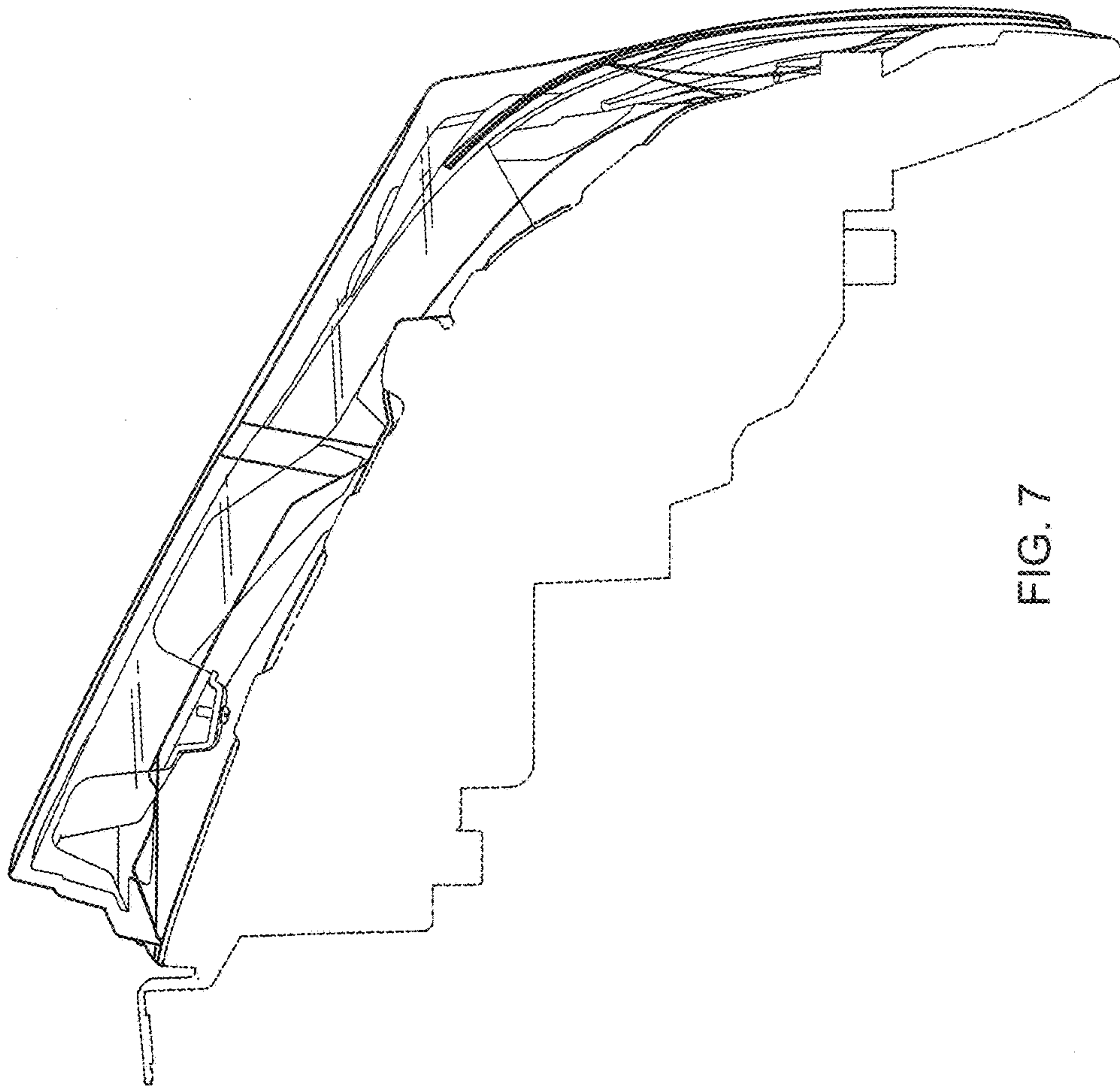

FIG. 7