



US00D812677S

(12) **United States Design Patent**
Vinsel

(10) **Patent No.:** **US D812,677 S**
(45) **Date of Patent:** **** Mar. 13, 2018**

(54) **UKULELE**

(71) Applicant: **Mark Daniel Vinsel**, Juneau, AK (US)

(72) Inventor: **Mark Daniel Vinsel**, Juneau, AK (US)

(**) Term: **15 Years**

(21) Appl. No.: **29/620,257**

(22) Filed: **Sep. 7, 2016**

(51) **LOC (11) Cl.** **17-03**

(52) **U.S. Cl.**
USPC **D17/14**

(58) **Field of Classification Search**
USPC D17/14-21, 99; D21/324
CPC G10D 1/00; G10D 1/08; G10D 1/085;
G10D 3/00; G10D 3/06; G10D 3/12;
G10D 3/02; G10H 3/00; G10H 3/18;
G10H 3/181

See application file for complete search history.

(56) **References Cited**

U.S. PATENT DOCUMENTS

- 475,541 A * 5/1892 Cross G10D 3/02
84/291
- 1,047,217 A * 12/1912 Hartnett G10D 3/02
84/273
- D74,178 S * 1/1928 Kaialilii D17/18
- D75,494 S * 6/1928 Healy D17/19
- D100,498 S * 7/1936 Johnson D17/19
- D162,521 S * 3/1951 Jones et al. D17/14
- 6,028,255 A * 2/2000 Myronyk G10D 3/06
84/290
- D612,414 S * 3/2010 Mills D17/14

FOREIGN PATENT DOCUMENTS

FR 533427 A * 3/1922 G10D 1/00

OTHER PUBLICATIONS

Amazon, Luna Mahogany Series Tattoo Soprano Pineapple Ukulele, first available on Oct. 1, 2009, [online], [site visited on Aug. 25, 2017]. Available from Internet, URL: https://www.amazon.com/Luna-Mahogany-Soprano-Pineapple-Ukulele/dp/B002SSUR3C/ref=sr_1_6?ie=UTF8&qid=1503700265&sr=8-6&keywords=luna+mahogany+ukulele.*

Amazon, KMakala Pineapple-Style Soprano Ukulele, first available on Nov. 21, 2008, [online], [site visited on Aug. 25, 2017]. Available from Internet, URL: https://www.amazon.com/Kala-KA-MK-P-Pineapple-Style-Soprano-Ukulele/dp/B001LU39F6/ref=sr_1_230?s=musical-instruments&ie=UTF8&qid=1503699944&sr=1-230&keywords=ukulele.*

* cited by examiner

Primary Examiner — Sheryl Lane
Assistant Examiner — Samantha Wood

(57) **CLAIM**

The ornamental design for a ukulele, as shown and described.

DESCRIPTION

FIG. 1 is a perspective view of my new ukulele design from left rear side;
FIG. 2 is a perspective view of my new ukulele design from right rear side;
FIG. 3 is a top view of my new ukulele design;
FIG. 4 is a bottom view of my new ukulele design;
FIG. 5 is a left side view of my new ukulele design;
FIG. 6 is a right side view of my new ukulele design;
FIG. 7 is rear view of my new ukulele design; and,
FIG. 8 is front view from of my new ukulele design.

1 Claim, 6 Drawing Sheets

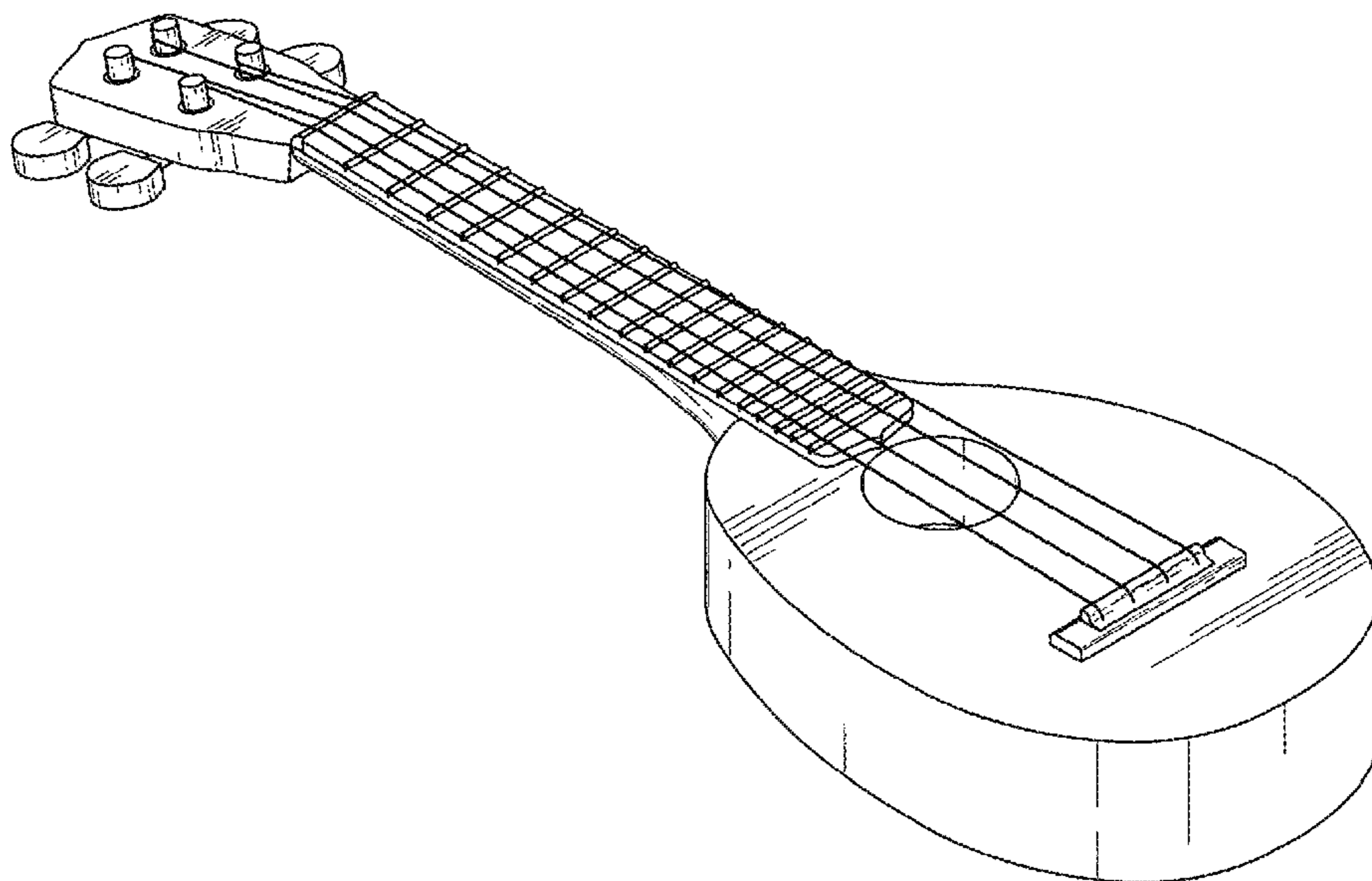

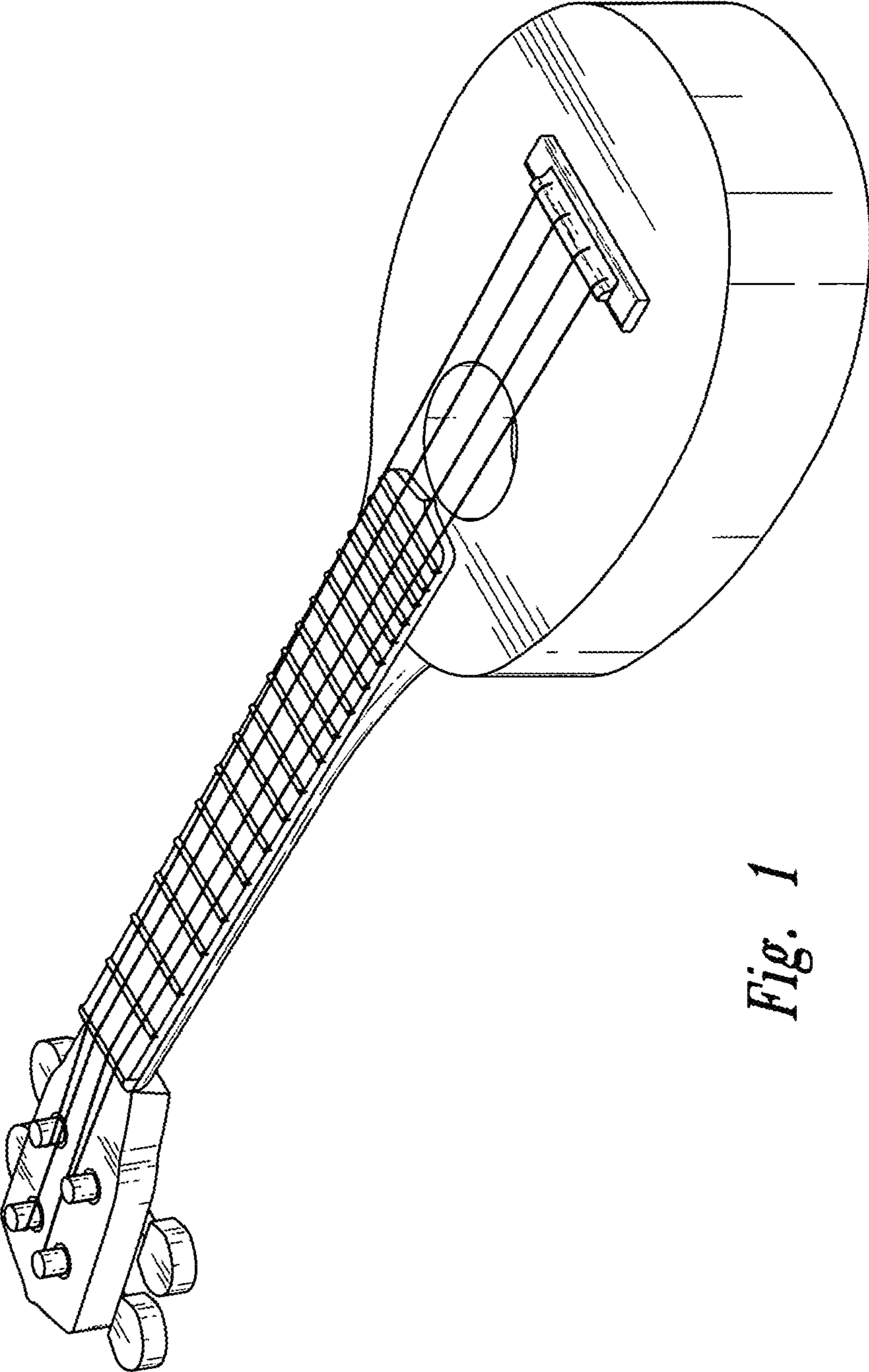

Fig. 1

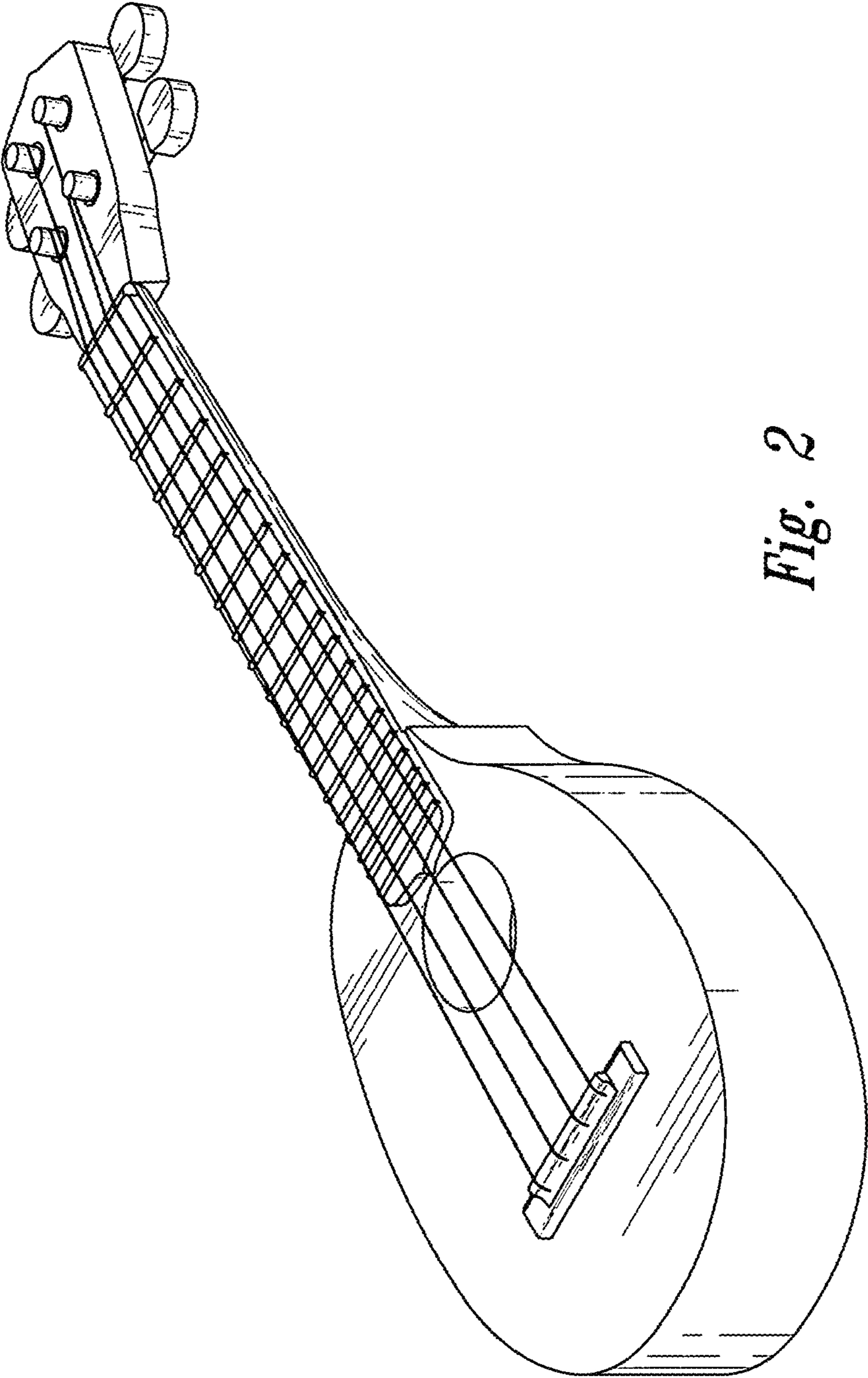

Fig. 2

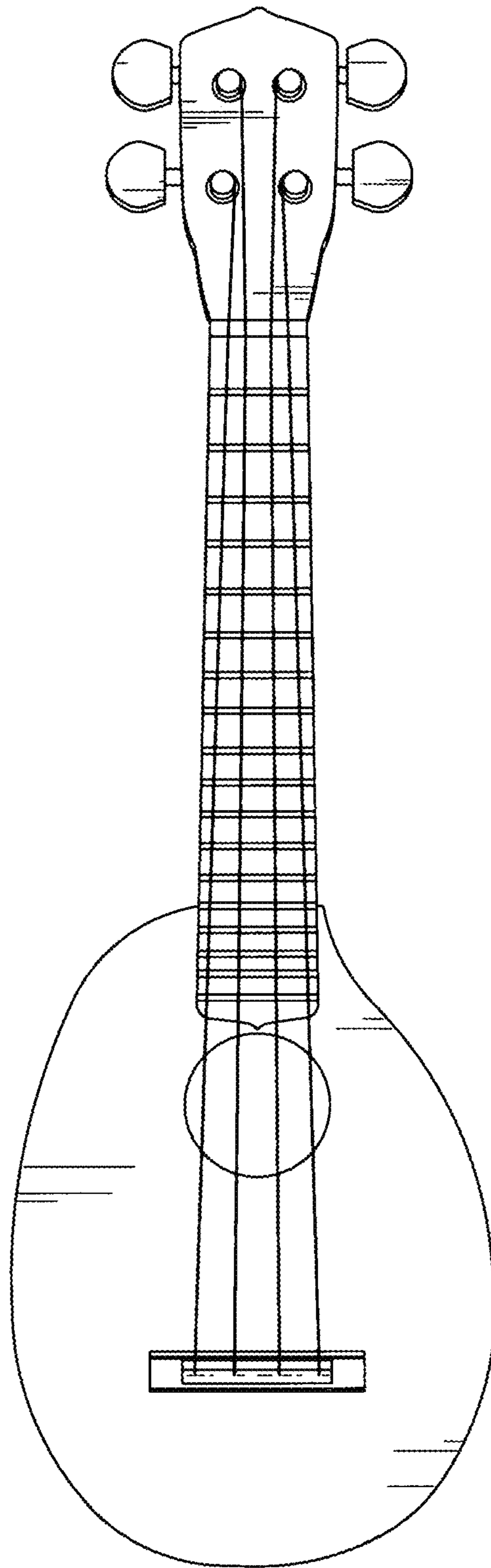

Fig. 3

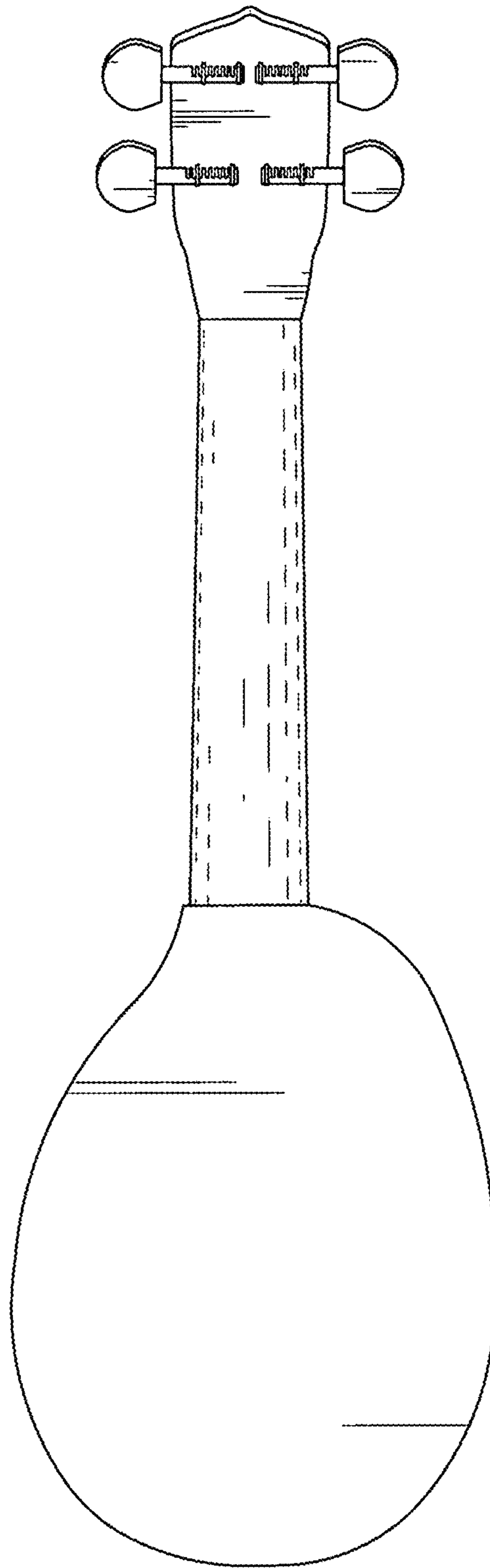

Fig. 4

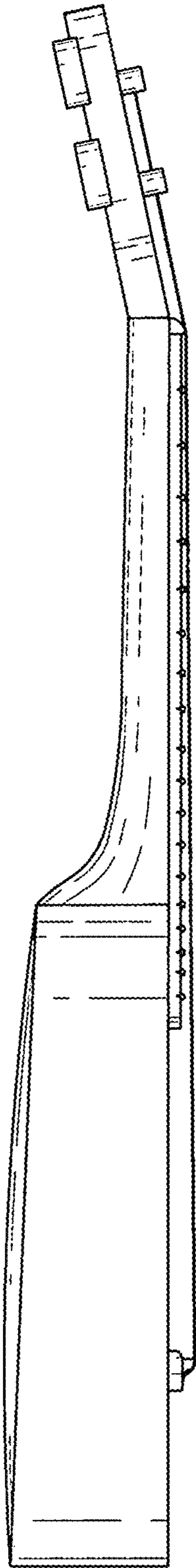

Fig. 5

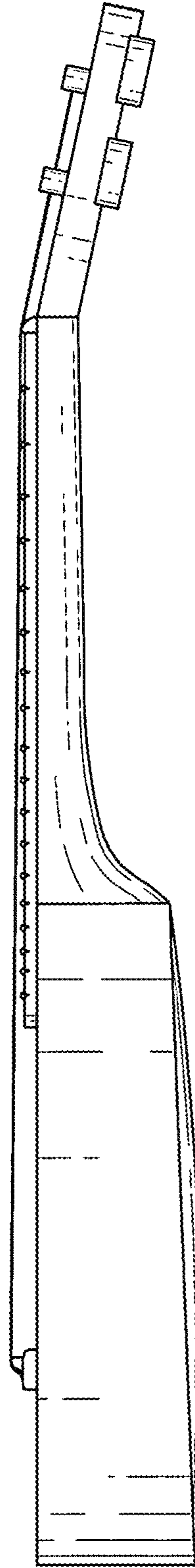

Fig. 6

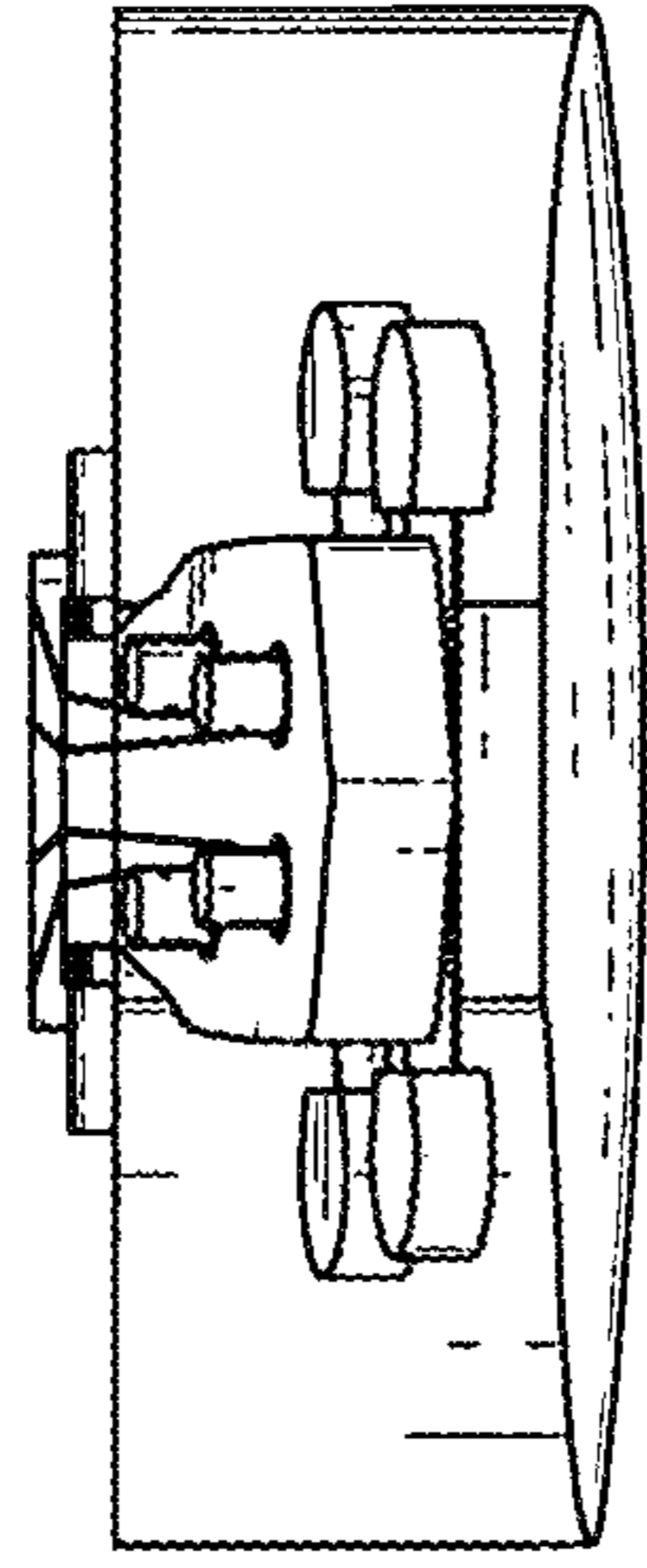

Fig. 7

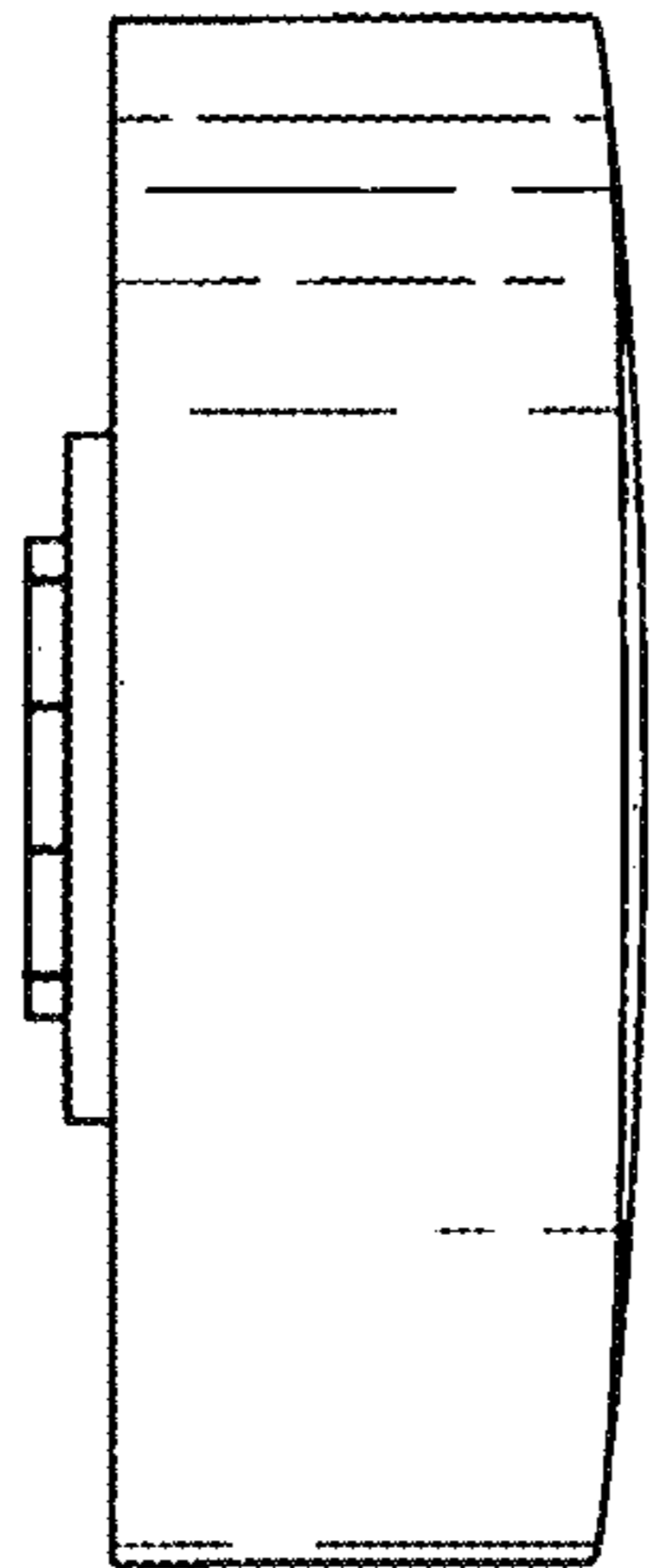

Fig. 8