



US00D812652S

(12) **United States Design Patent** (10) **Patent No.:** **US D812,652 S**
Kim (45) **Date of Patent:** **** Mar. 13, 2018**

(54) **REFRIGERATOR**

D656,967 S * 4/2012 Yi D15/86
D673,189 S * 12/2012 Kwak D15/86
D681,075 S * 4/2013 Yi D15/86

(71) Applicant: **LG ELECTRONICS INC.**, Seoul (KR)

(Continued)

(72) Inventor: **Miok Kim**, Seoul (KR)

Primary Examiner — Richard E Chilcot

(73) Assignee: **LG Electronics Inc.**, Seoul (KR)

(74) *Attorney, Agent, or Firm* — Birch, Stewart, Kolasch & Birch, LLP

(**) Term: **15 Years**

(57) **CLAIM**

(21) Appl. No.: **35/501,632**

The ornamental design for a refrigerator, as shown and described.

(22) Filed: **Mar. 31, 2016**

DESCRIPTION

(80) **Hague Agreement Data**

Int. Filing Date: **Mar. 31, 2016**
Int. Reg. No.: **DM/091206**
Int. Reg. Date: **Mar. 31, 2016**
Int. Reg. Pub. Date: **Sep. 30, 2016**

1. Refrigerator
1.1 is a perspective view of a refrigerator showing my new design;
1.2 is a front elevation view thereof;
1.3 is a rear elevation view thereof;
1.4 is a left-side elevation view thereof;
1.5 is a right-side elevation view thereof;
1.6 is a top plan view thereof;
1.7 is a bottom plan view thereof;
1.8 is a perspective view thereof, wherein each outer door is in an opened position;
1.9 is a front view thereof, wherein each outer door is in an opened position;
1.10 is a right-side view thereof, wherein each outer door is in an opened position;
1.11 is a top plan view thereof, wherein each outer door is in an opened position;
1.12 is a perspective view thereof, wherein each of the inner and outer doors is in an opened position;
1.13 is a front view thereof, wherein each of the inner and outer doors is in an opened position;
1.14 is a right-side view thereof, wherein each of the inner and outer doors is in an opened position;
1.15 is a top plan view thereof, wherein each of the inner and outer doors is in an opened position; and
1.16 is a perspective view thereof, wherein the inside of each outer door is seen through a 'see-through' type of window.

(30) **Foreign Application Priority Data**

Oct. 8, 2015 (KR) 30-2015-0050864

(51) **LOC (11) Cl.** **15-07**

(52) **U.S. Cl.**
USPC **D15/91**
CPC **F25D 25/025 (2013.01)**

(58) **Field of Classification Search**

USPC D15/79-91
CPC F25D 25/025; F25D 23/028; F25D 2323/024; F25D 23/00; F25D 23/02; F25D 2323/021; F25D 23/065; F25D 11/00; F25D 2201/14; F25D 23/021; F25D 23/025; F25D 23/04; F25D 27/00; F25D 23/062

See application file for complete search history.

(56) **References Cited**

U.S. PATENT DOCUMENTS

D615,565 S * 5/2010 Kristiansen D15/86
D629,022 S * 12/2010 Cho D15/85

(Continued)

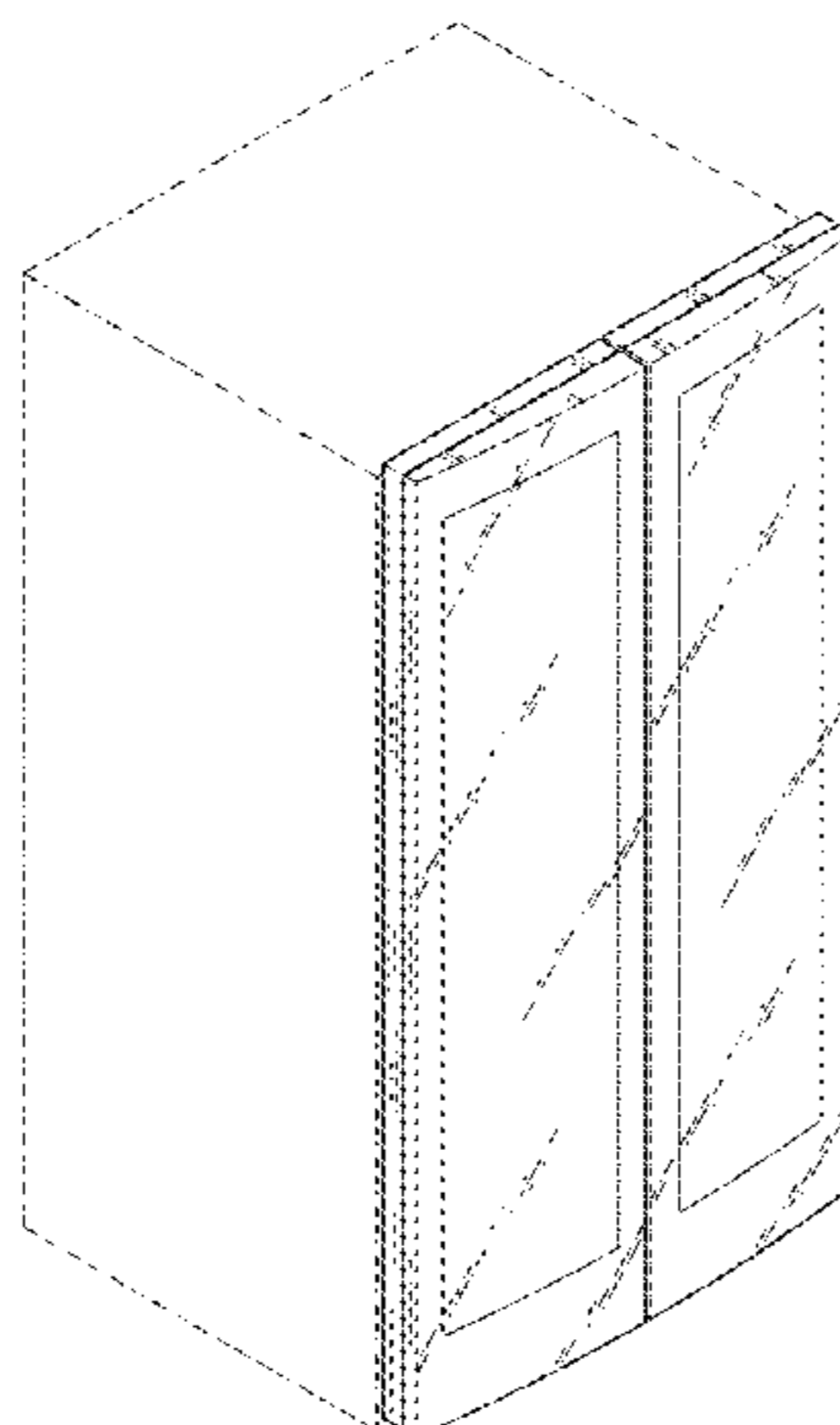

The broken lines shown are included for the purpose of illustrating unclaimed portions of the refrigerator and form no part of the claimed design.

1 Claim, 15 Drawing Sheets

(56) **References Cited**

U.S. PATENT DOCUMENTS

D691,644 S *	10/2013	Cho	D15/86
D701,539 S *	3/2014	Saejin	D15/85
D702,739 S *	4/2014	Kim	D15/86
D724,629 S *	3/2015	Choi	D15/85
D729,286 S *	5/2015	Kwak	D15/85
D732,584 S *	6/2015	Sin	D15/86
D742,434 S *	11/2015	Yeo	D15/86
D760,820 S	7/2016	Lee et al.	
D760,821 S	7/2016	Lee	
D760,822 S	7/2016	Lee	
D760,823 S	7/2016	Lee et al.	
D760,824 S	7/2016	Lee	
D761,336 S	7/2016	Lee et al.	
D767,648 S *	9/2016	Shoemaker	D15/86
D780,815 S	3/2017	Seo et al.	
D788,193 S	5/2017	Seo et al.	
D788,194 S	5/2017	Kwak et al.	

* cited by examiner

1.1

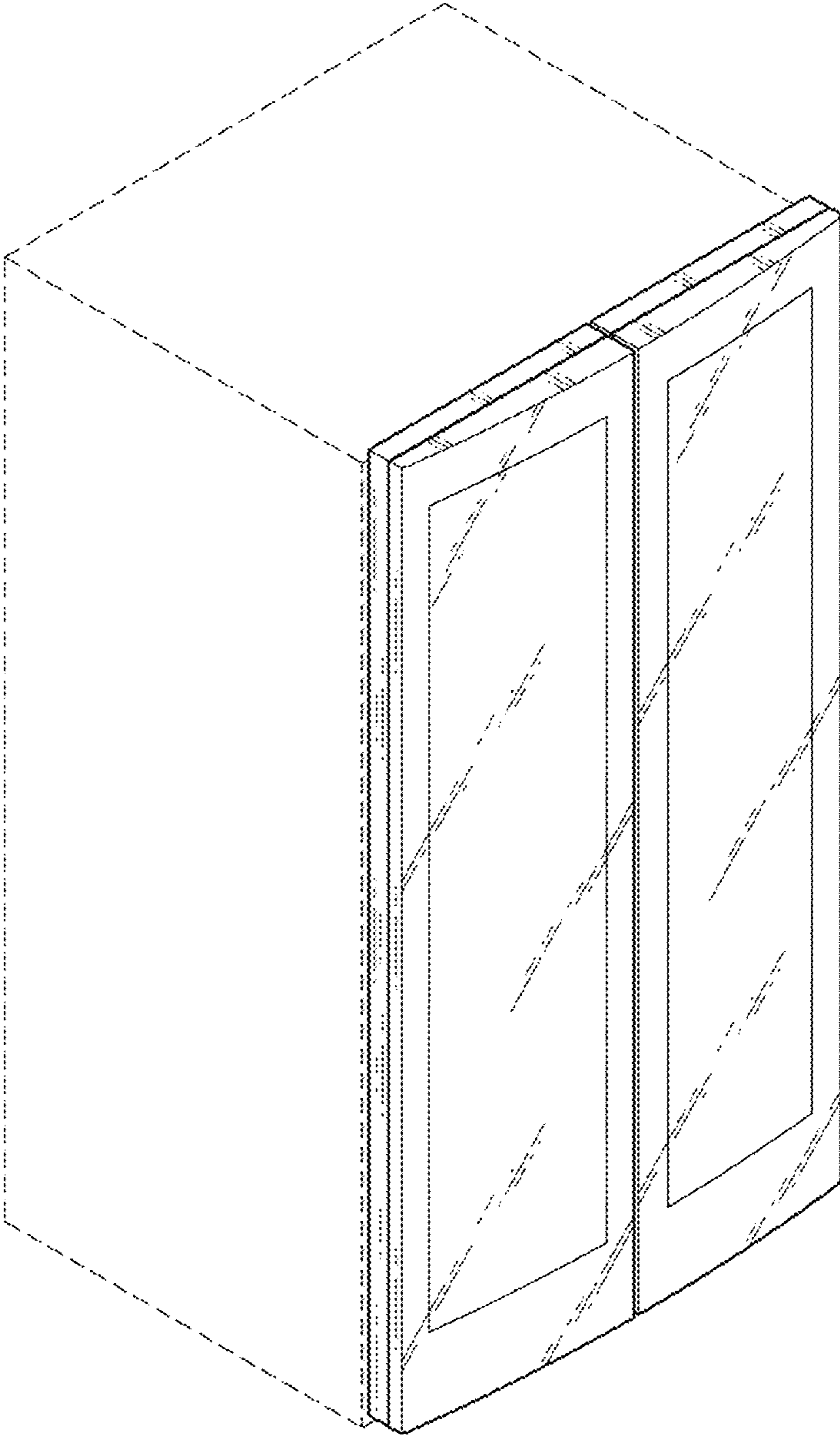

1.2

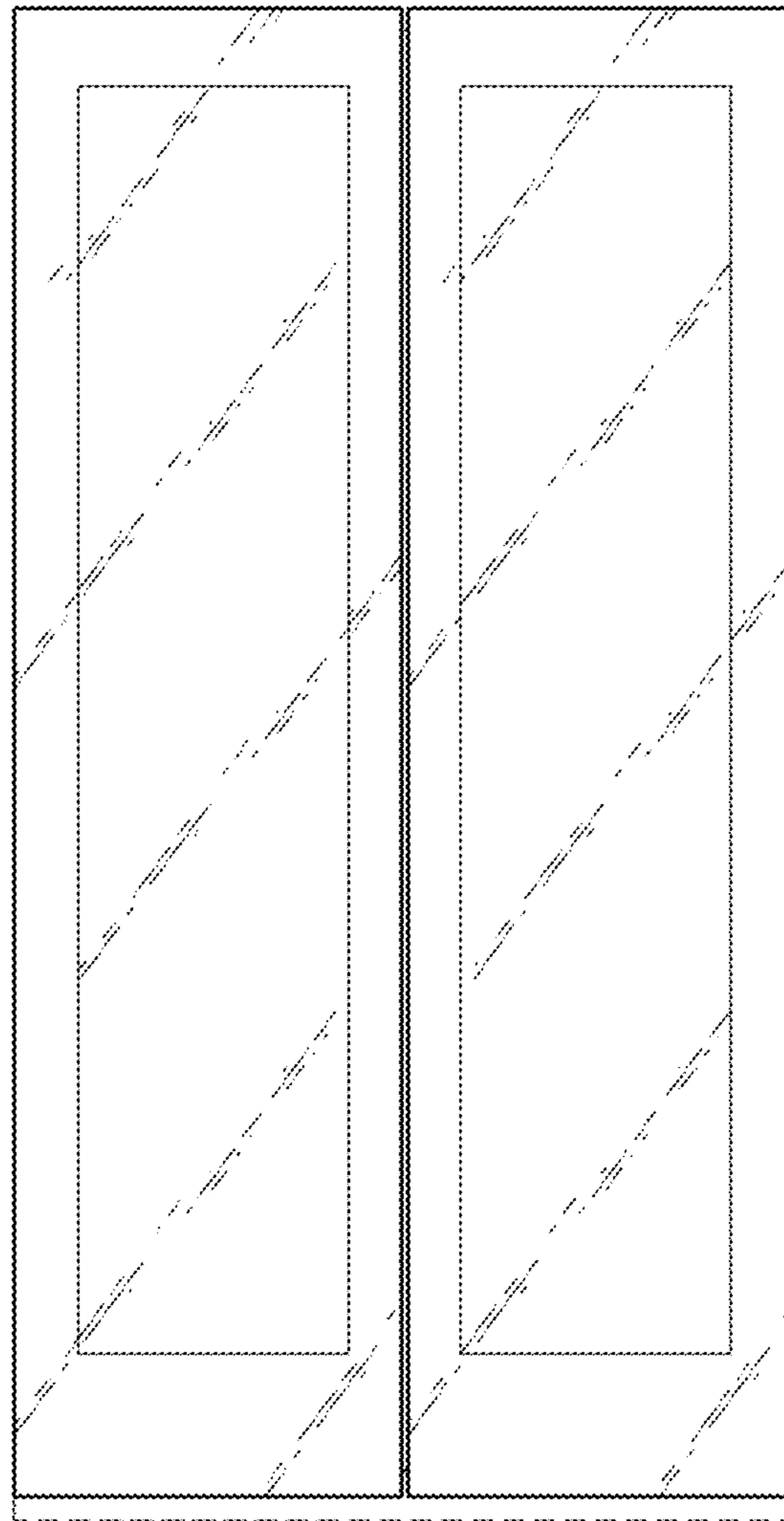

1.3

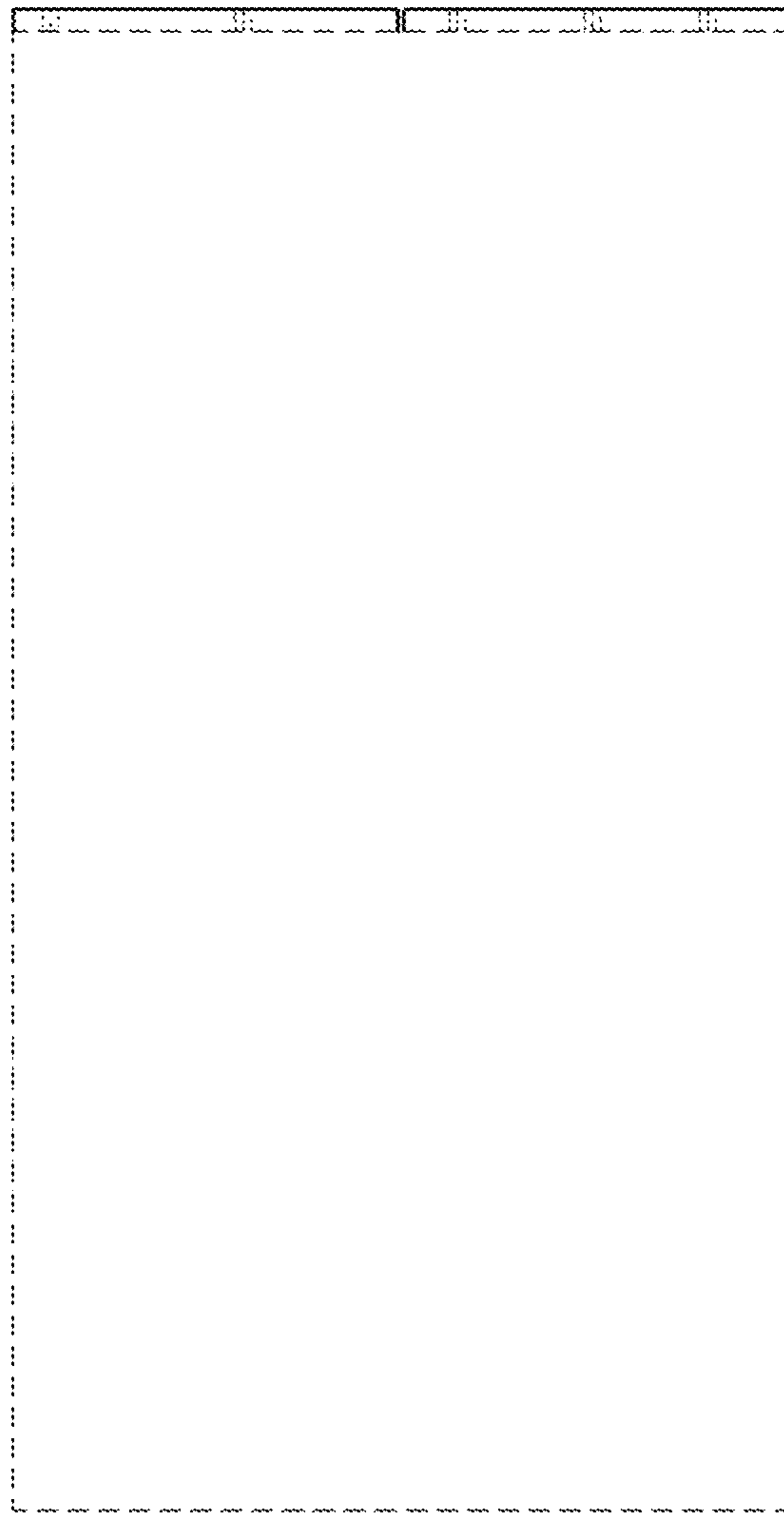

1.4

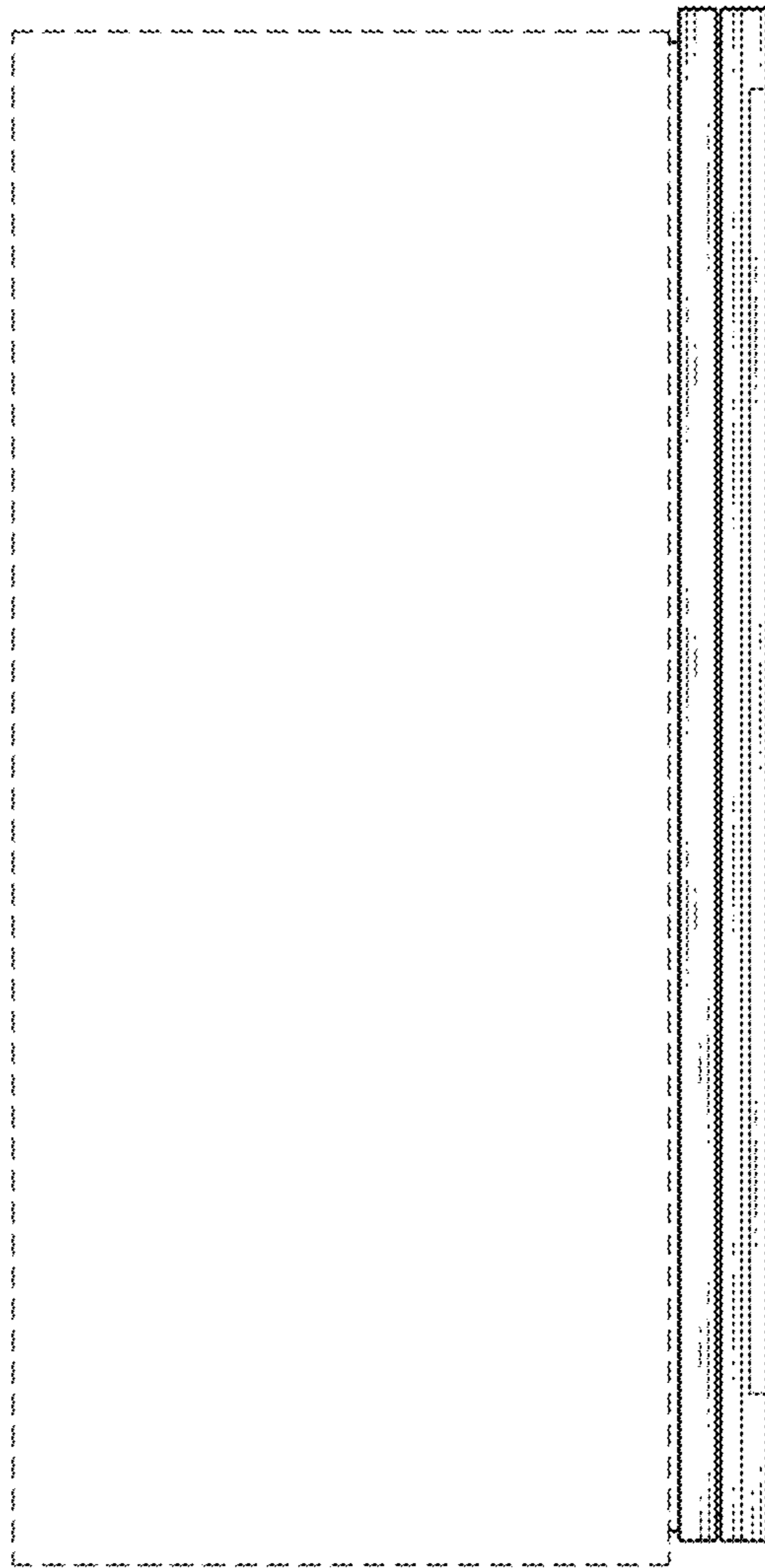

1.5

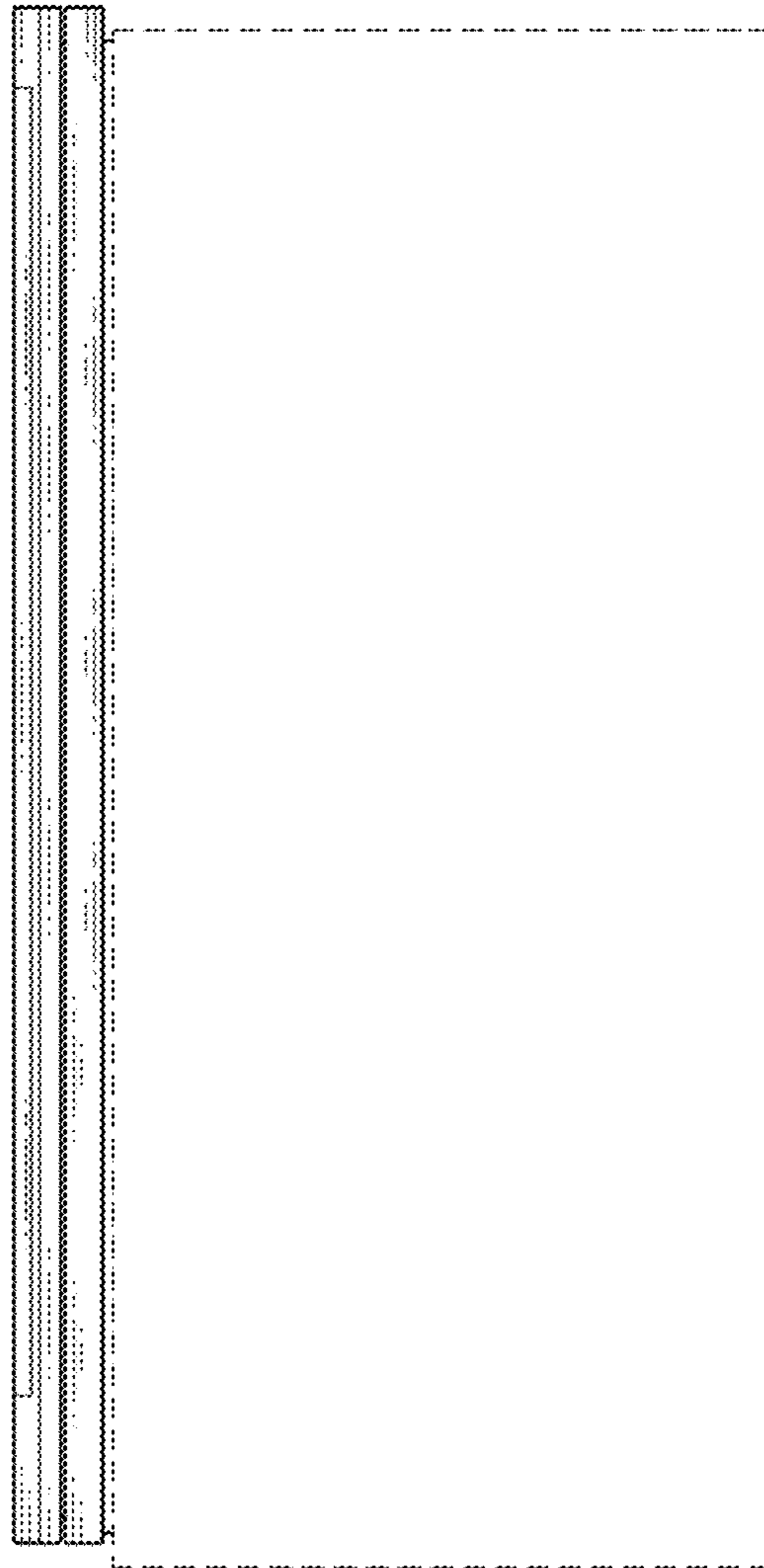

1.6

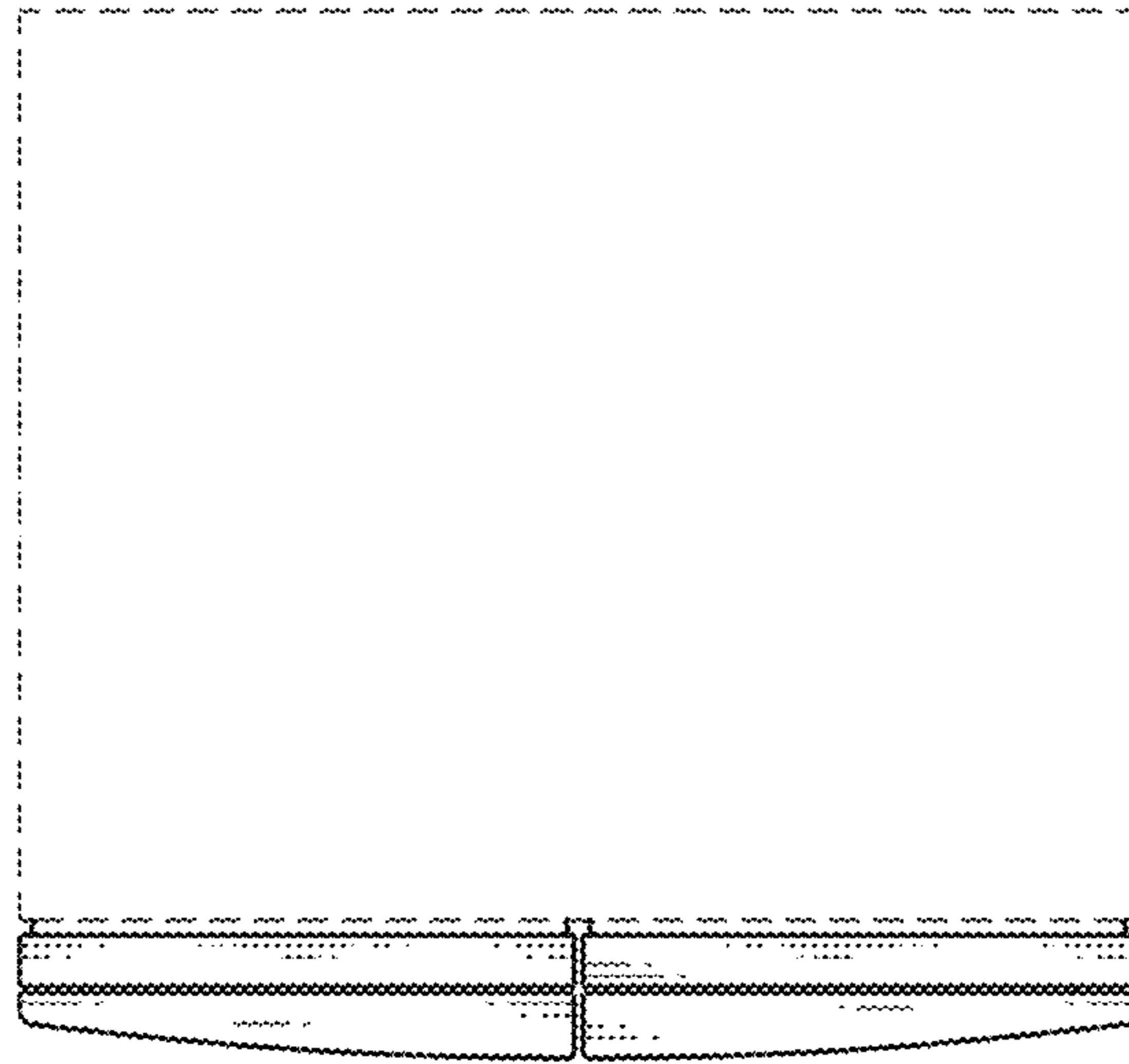

1.7

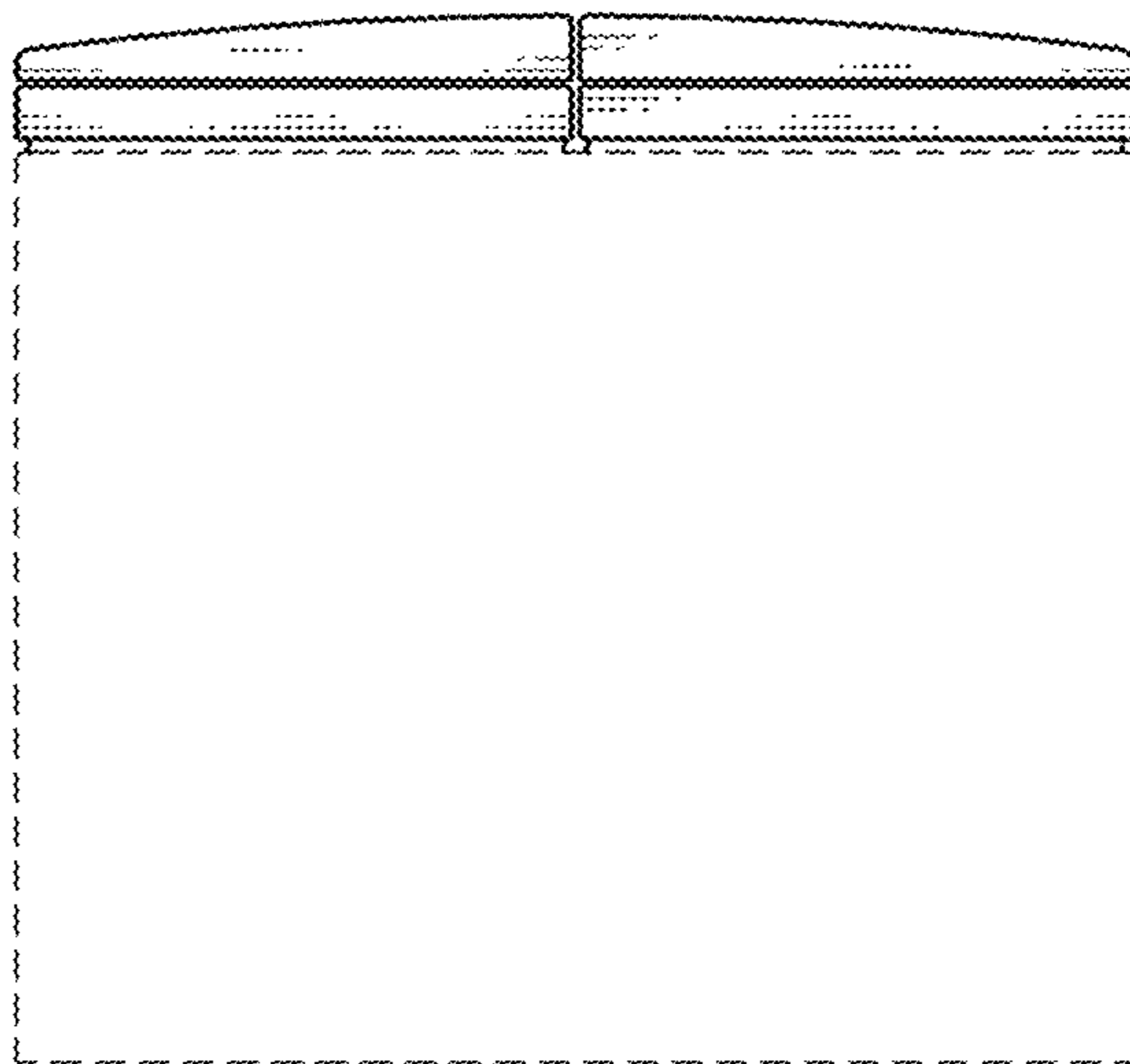

1.8

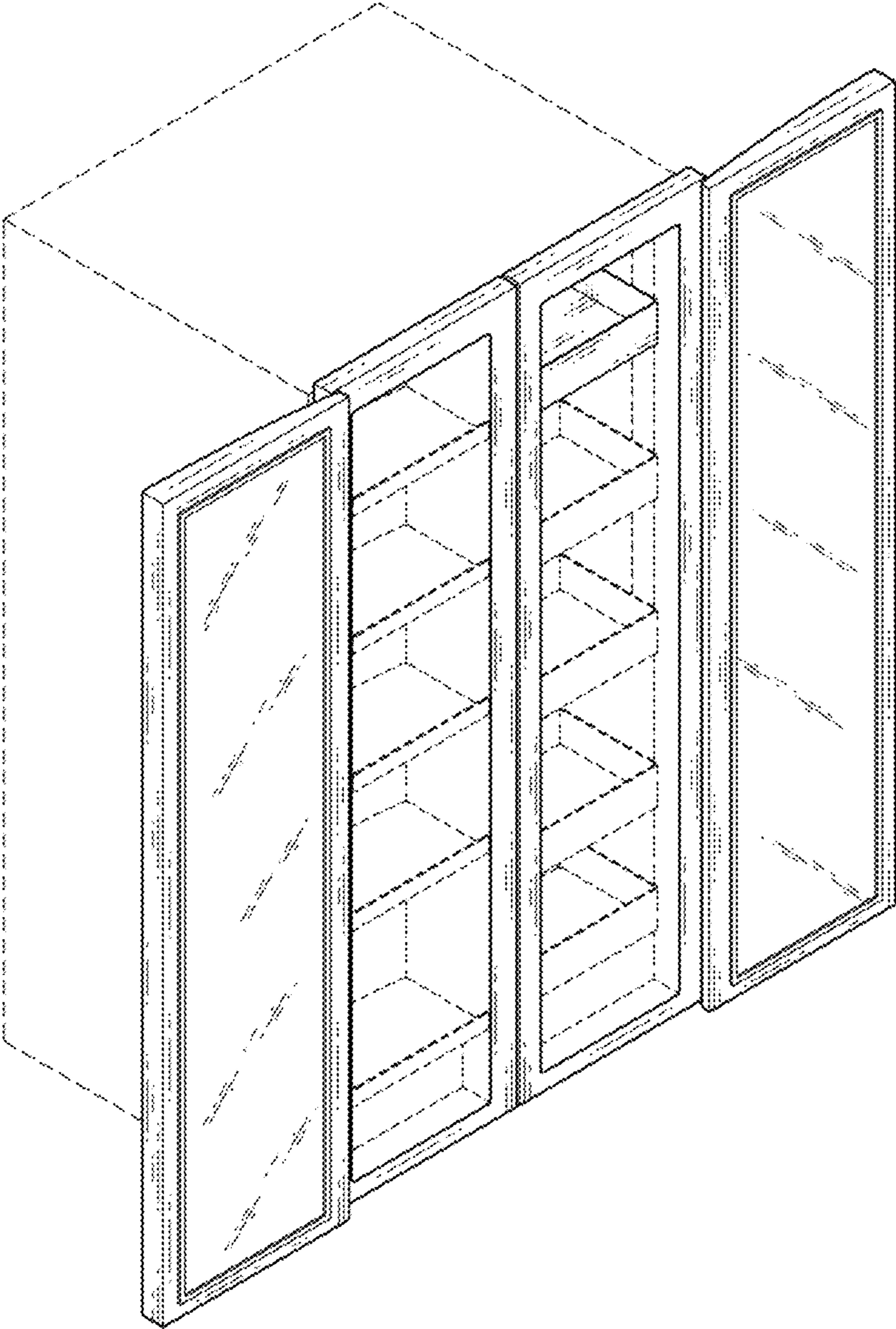

1.9

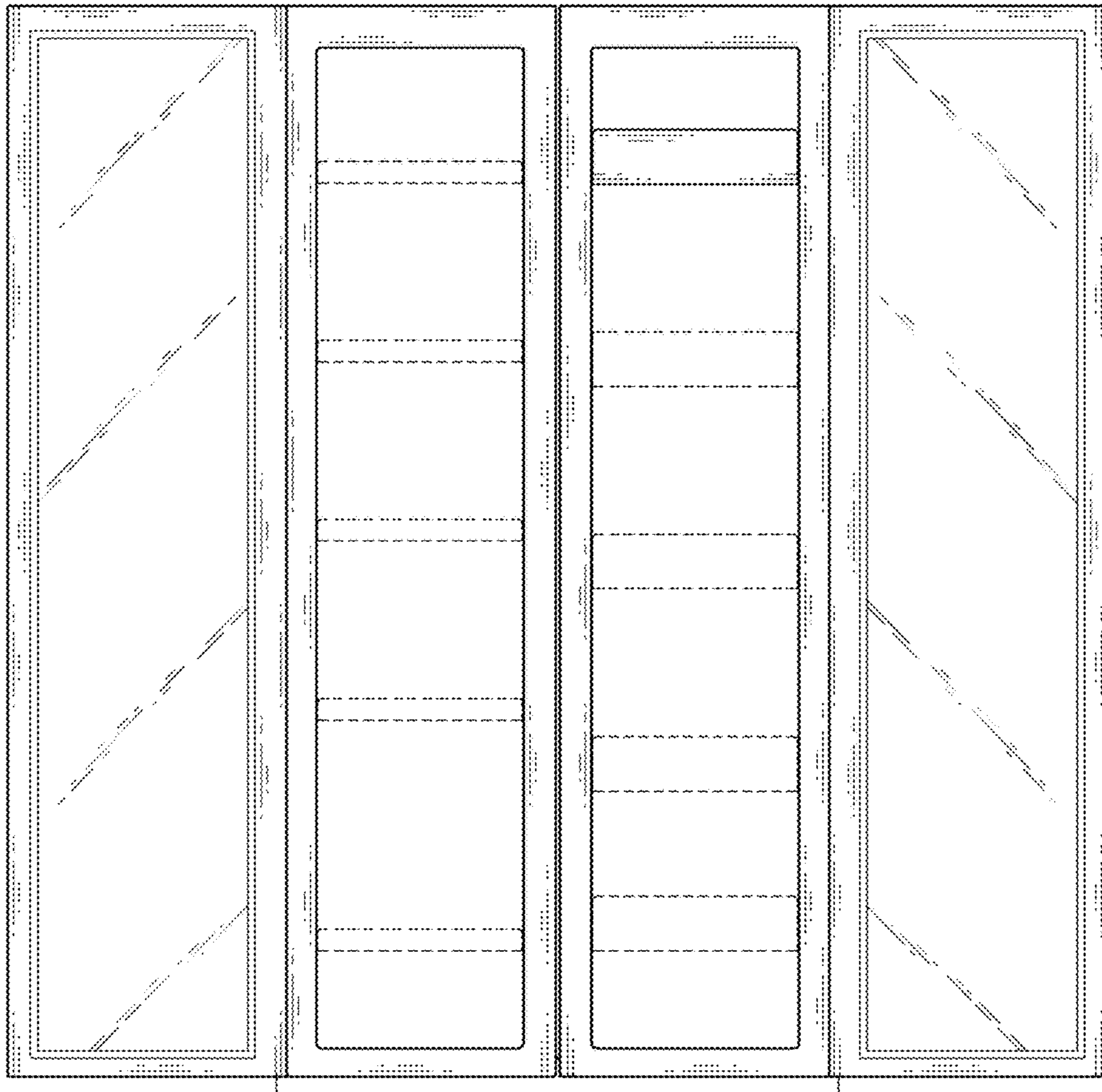

1.10

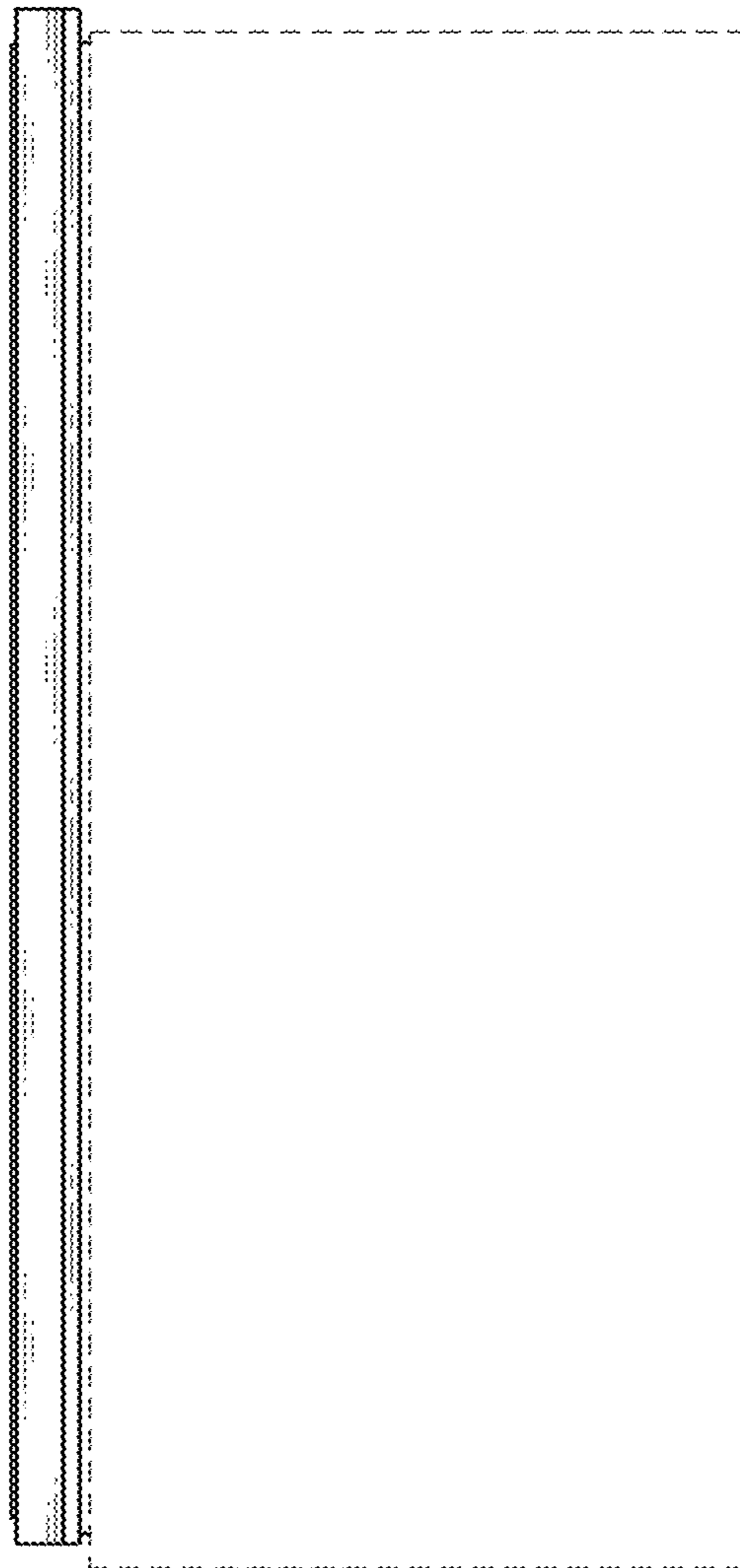

1.11

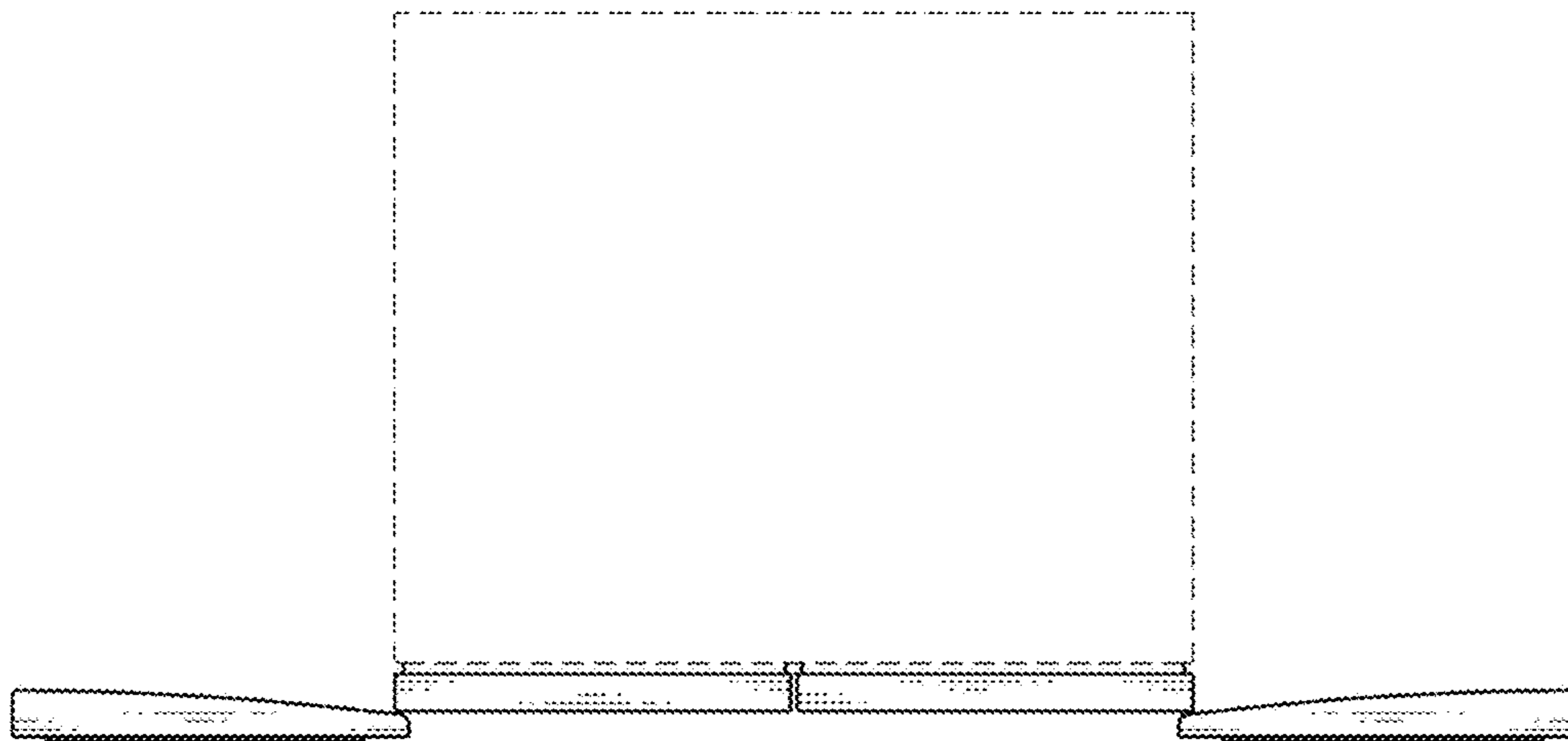

1.12

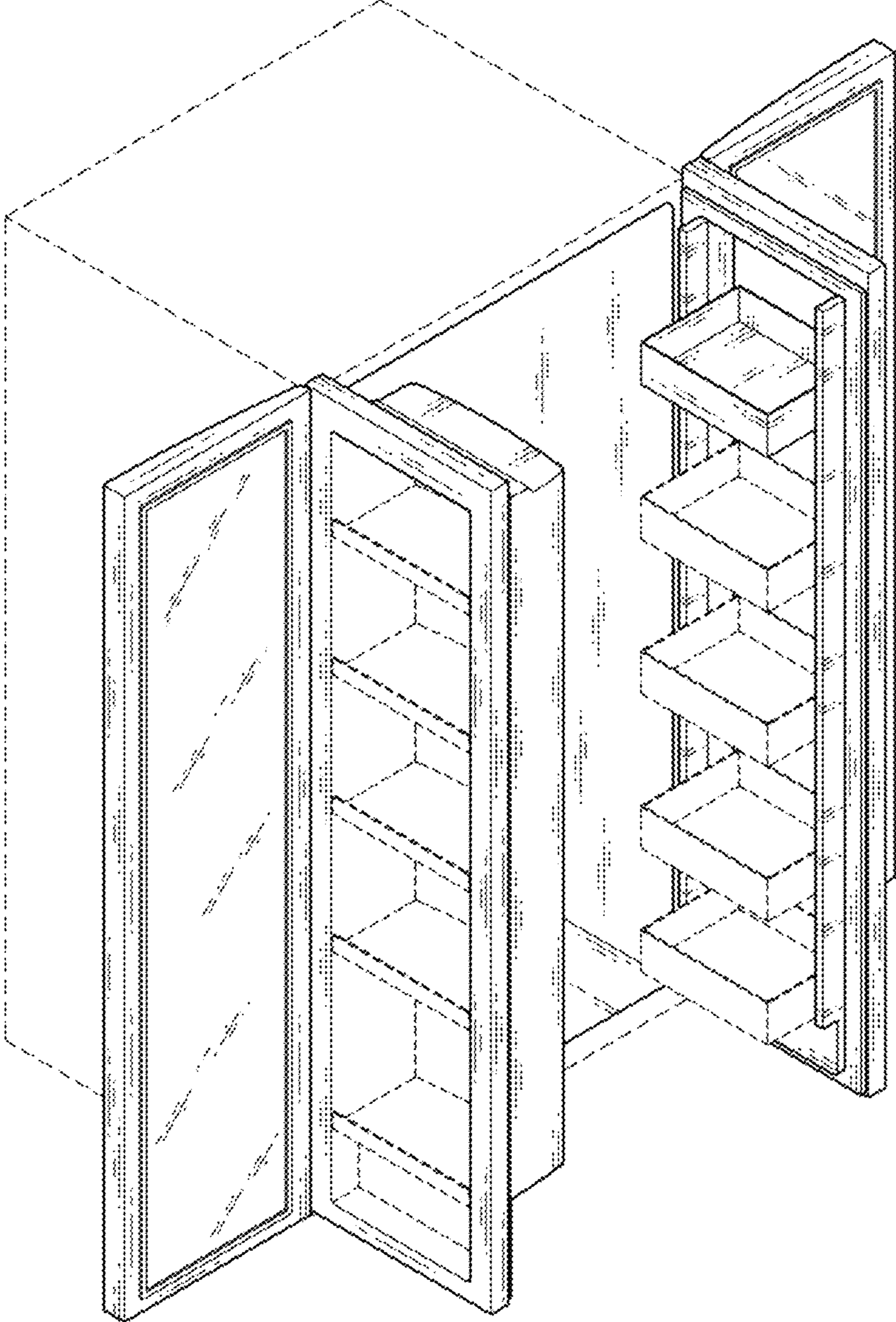

1.13

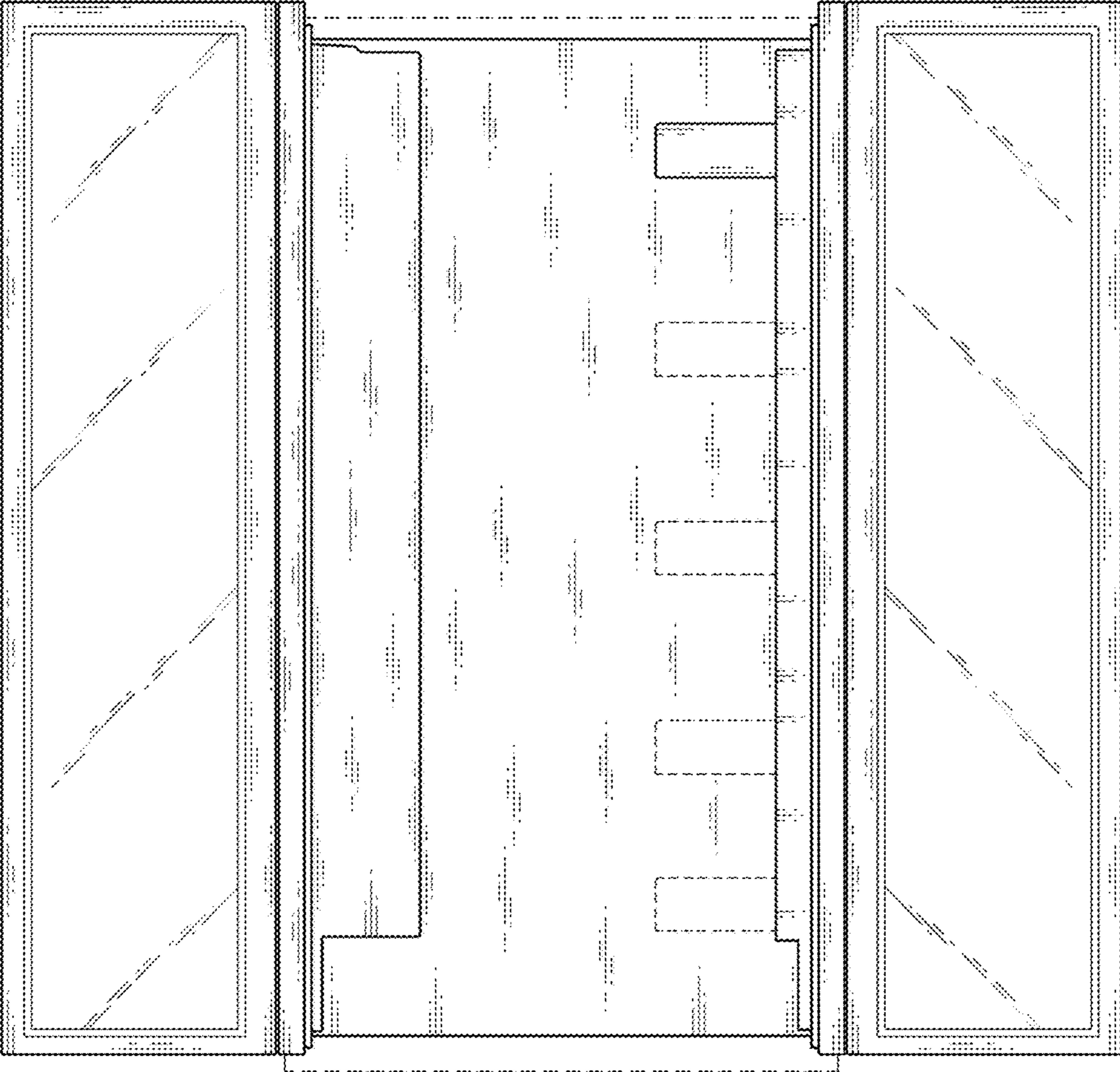

1.14

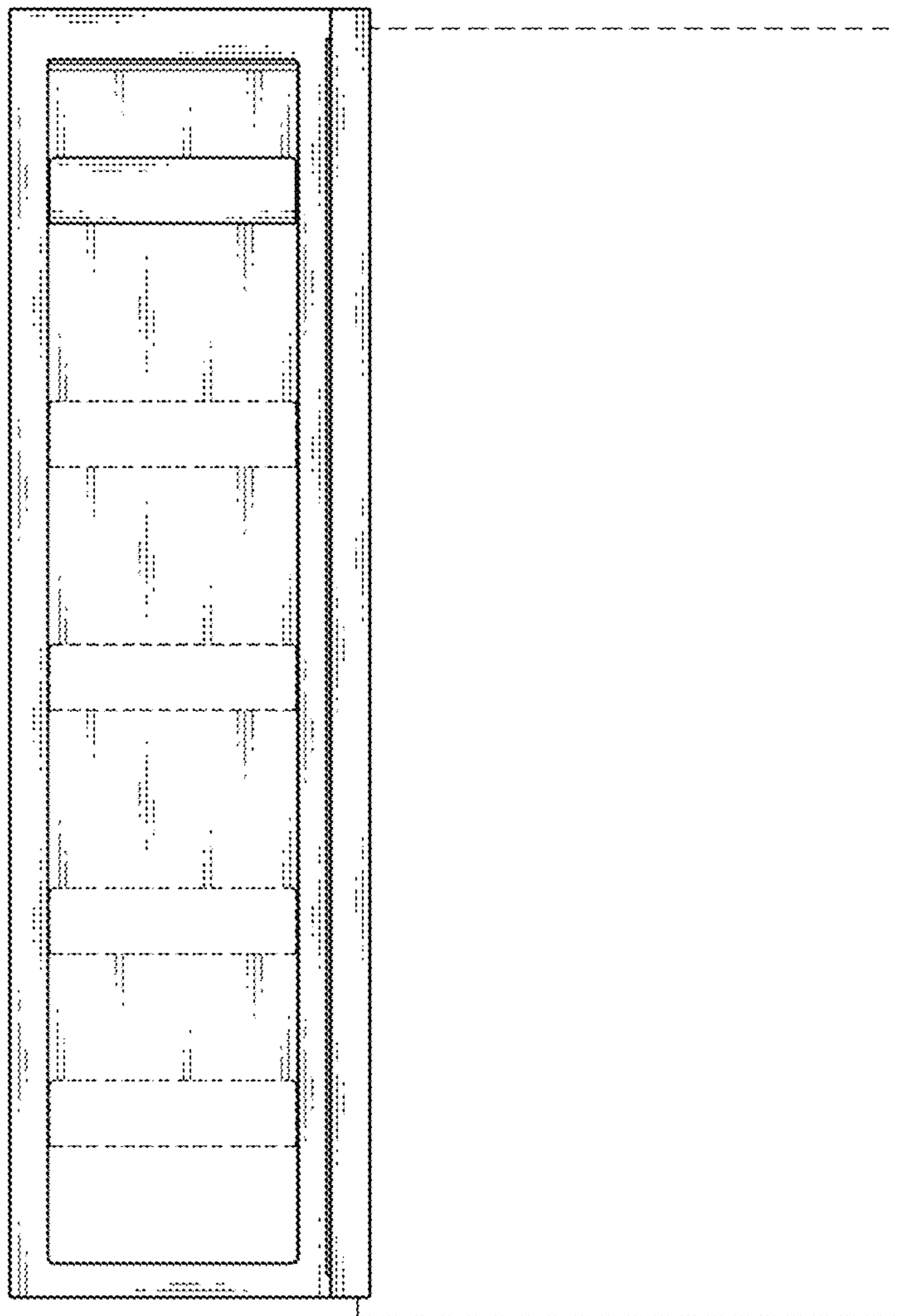

1.15

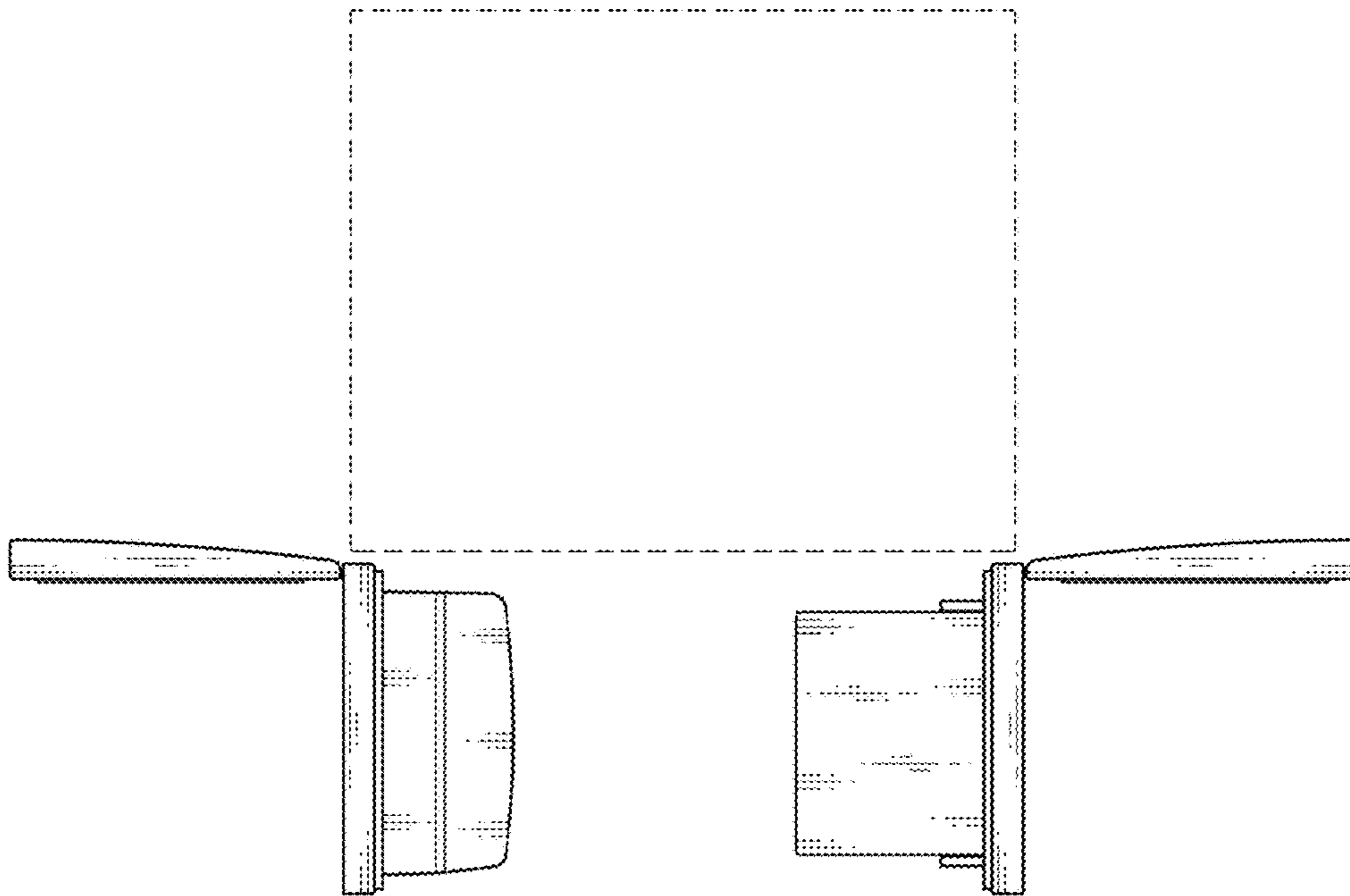

1.16

