



US00D812621S

(12) **United States Design Patent**
Nyholm et al.

(10) **Patent No.:** **US D812,621 S**
(45) **Date of Patent:** **** Mar. 13, 2018**

(54) **CASE FOR A TABLET SHAPED DEVICE**

Primary Examiner — Cynthia Underwood

(71) Applicant: **STM Management Pty Ltd,**
Alexandria, NSW (AU)

(74) *Attorney, Agent, or Firm* — Christensen, Fonder,
Dardi & Herbert PLLC

(72) Inventors: **Ethan Nyholm,** North Bondi (AU);
Cambell Smyth, Highgate Hill (AU)

(57) **CLAIM**

(73) Assignee: **STM Management Pty Ltd,**
Alexandria NSW (AU)

We claim the ornamental design for case for a tablet shaped device, as shown and described.

(**) Term: **15 Years**

(21) Appl. No.: **29/585,328**

(22) Filed: **Nov. 22, 2016**

DESCRIPTION

(30) **Foreign Application Priority Data**

May 24, 2016 (AU) 201612767

(51) **LOC (11) Cl.** **14-02**

(52) **U.S. Cl.**
USPC **D14/440**

(58) **Field of Classification Search**
USPC D14/440, 250, 447, 433, 434; 206/45.23,
206/320, 45.2; 361/679.55; 294/25;
224/218

CPC ... G06F 1/1628; G06F 1/1626; A47B 23/044;
H04B 1/3888

See application file for complete search history.

FIG. 1 is a front bottom perspective view of a case for a tablet shaped device.

FIG. 2 is another side front bottom perspective view of a case for a tablet shaped device.

FIG. 3 is a rear bottom view of the case for a tablet shaped device.

FIG. 4 is a top view of the case for a tablet shaped device.

FIG. 5 is a rear view of the case for a tablet shaped device.

FIG. 6 is a left side view of the case for a tablet shaped device.

FIG. 7 is a front bottom perspective view of the case for a tablet shaped device; and,

FIG. 8 is a front bottom perspective view of the case for a tablet shaped device.

The portions of the figures shown in dashed lines are not part of the claimed invention.

(56) **References Cited**

U.S. PATENT DOCUMENTS

D757,731 S * 5/2016 Nguyen D14/440
D764,474 S * 8/2016 Penn D14/440
D764,475 S * 8/2016 Penn D14/440
D775,132 S * 12/2016 Smith D14/440

* cited by examiner

1 Claim, 8 Drawing Sheets

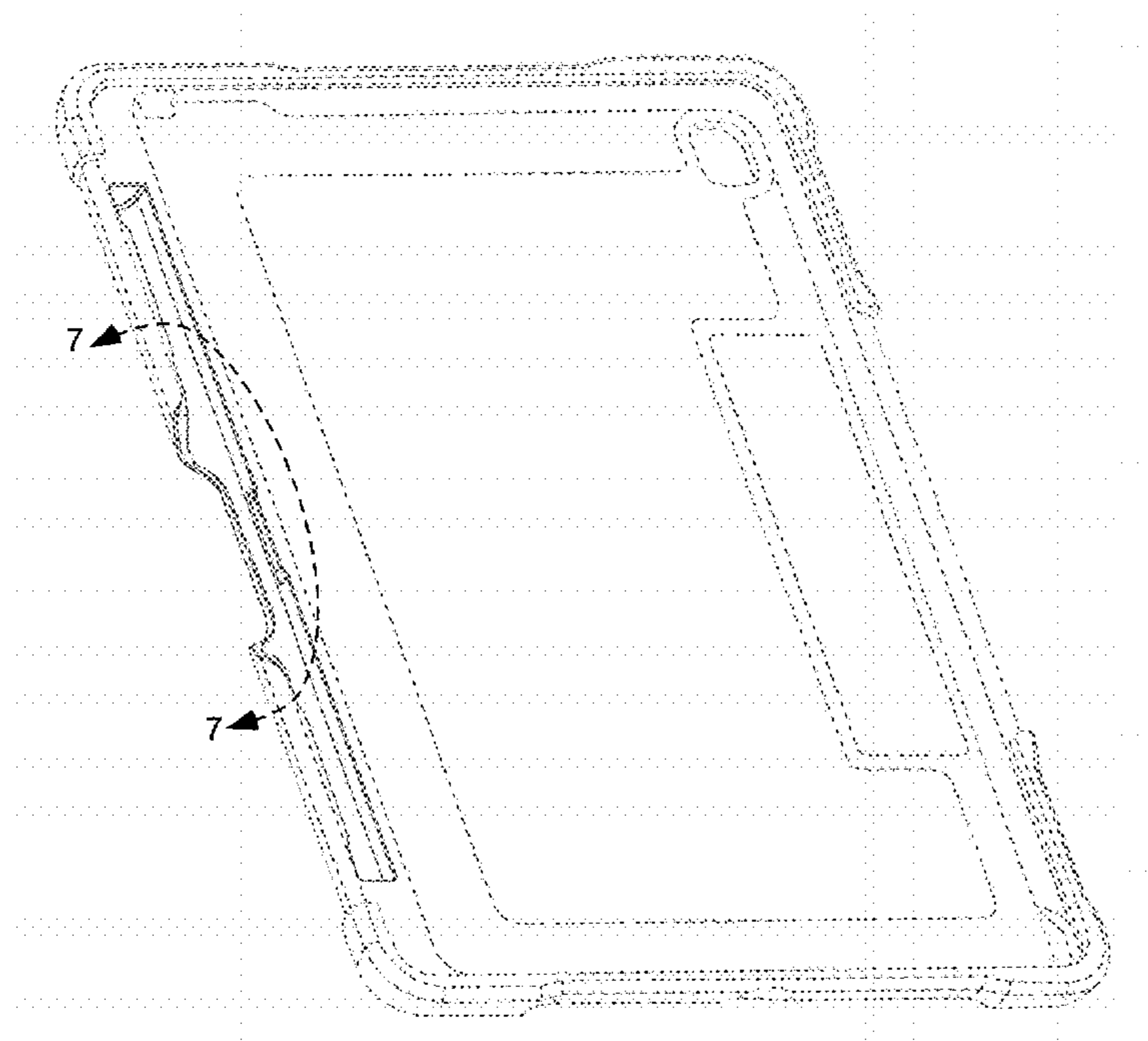

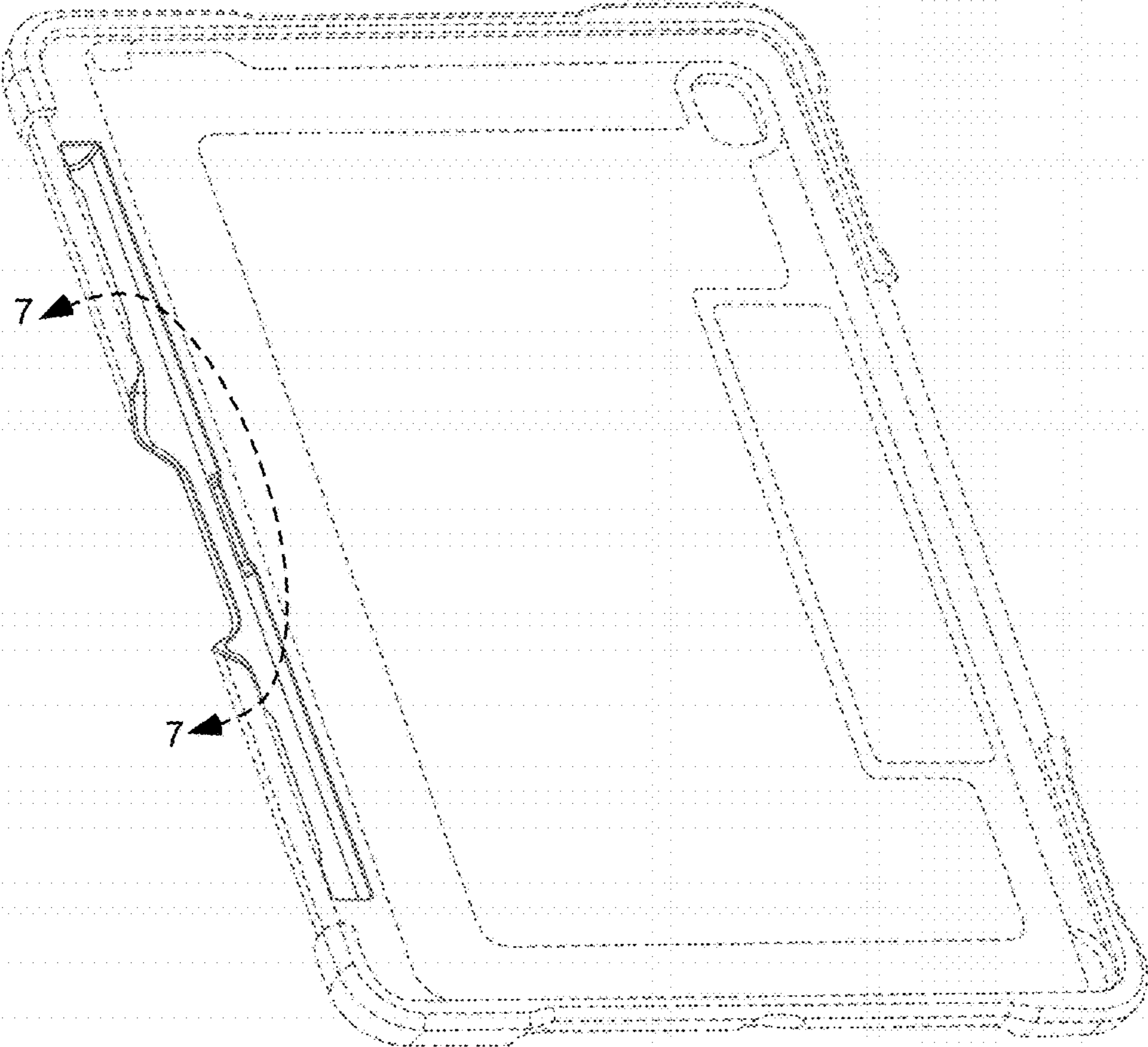

FIG. 1

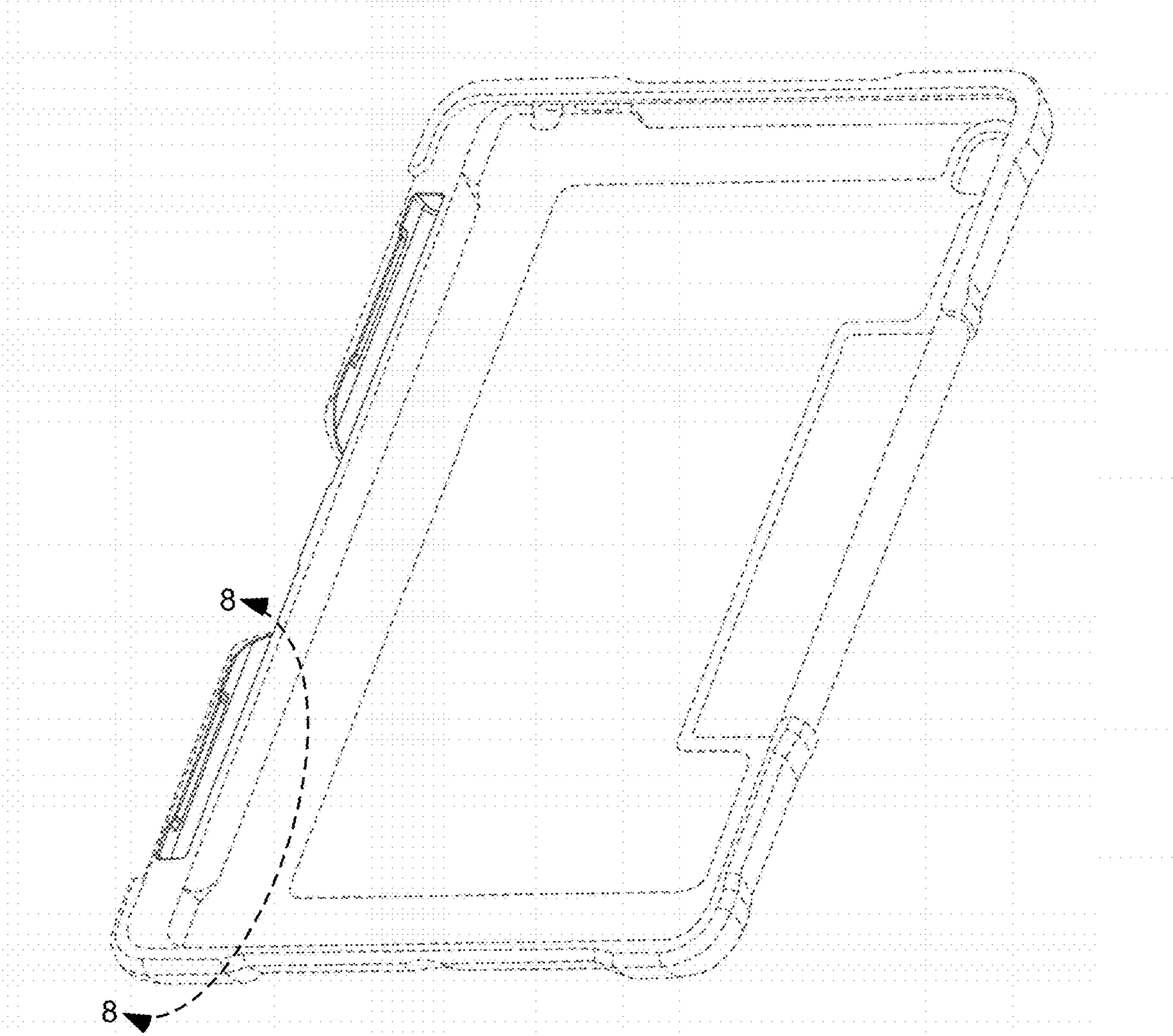

FIG. 2

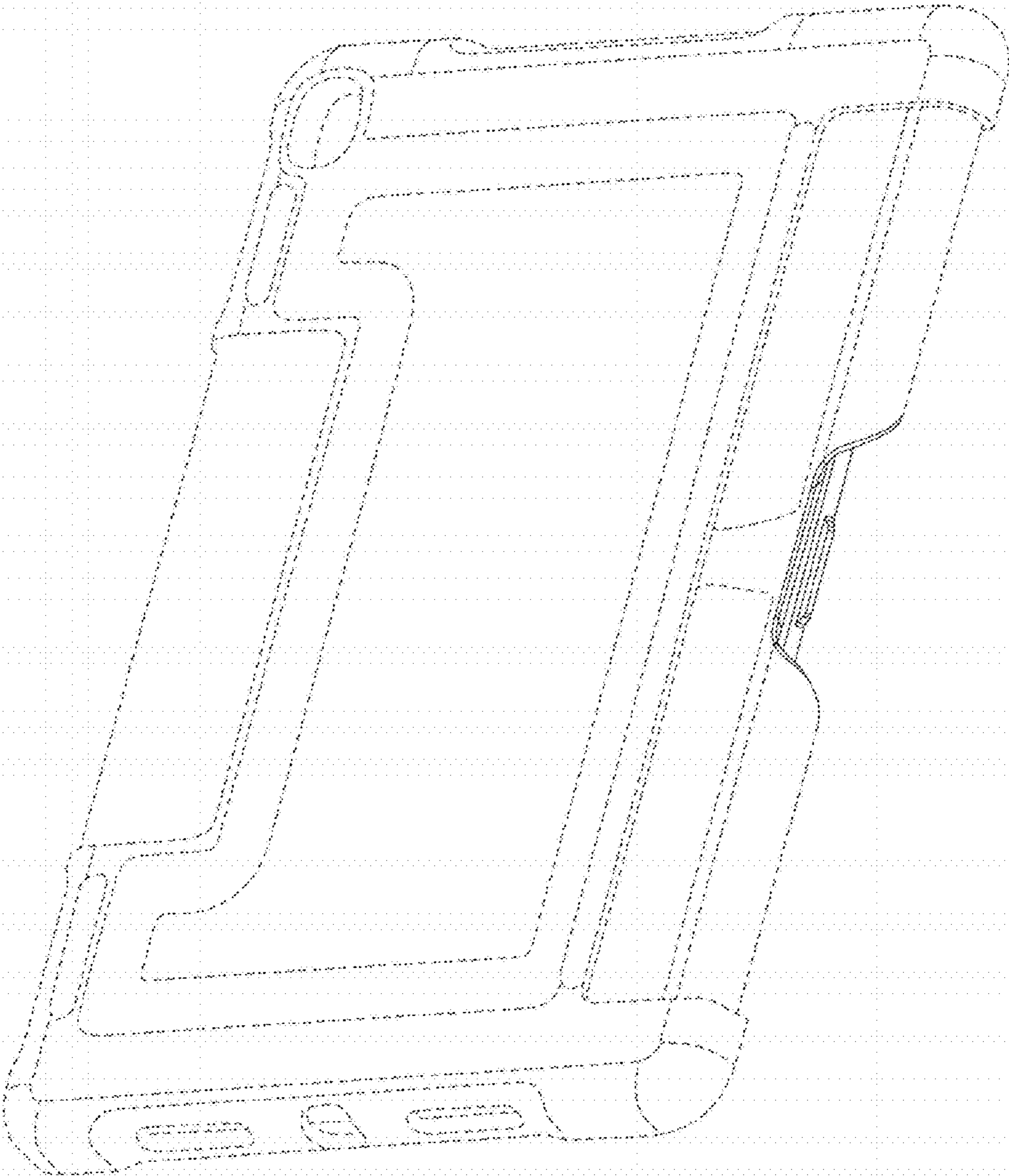

FIG. 3

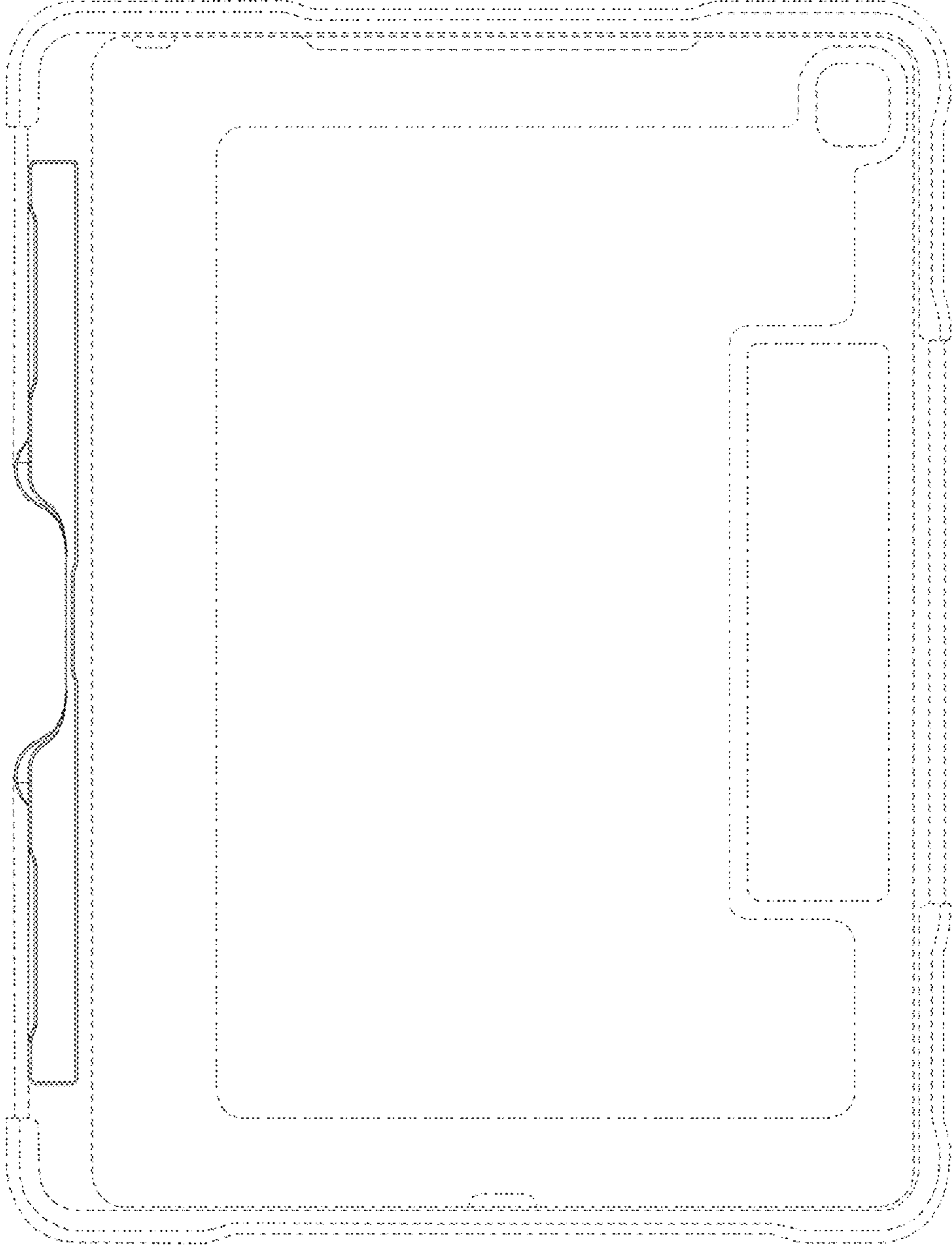

FIG. 4

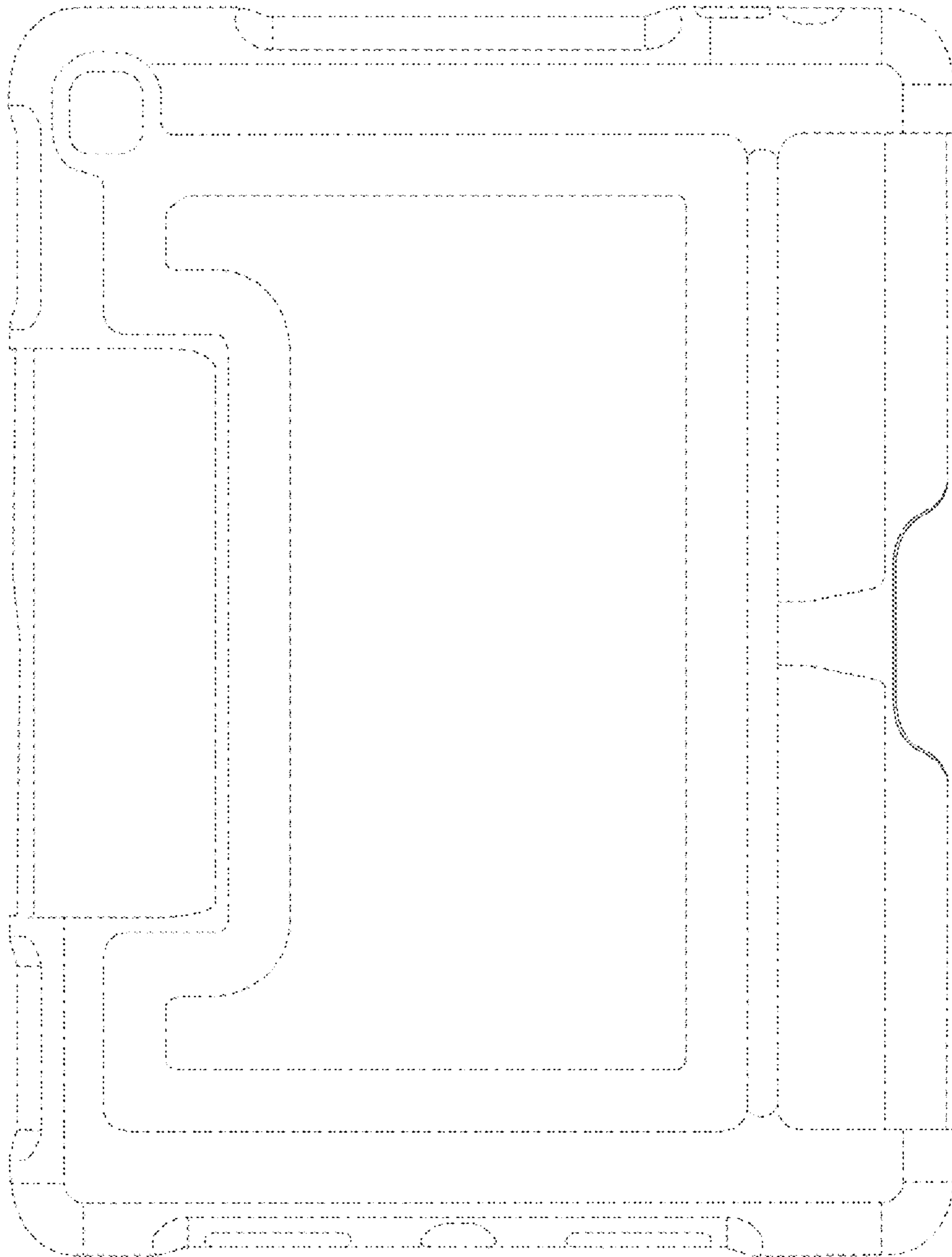

FIG. 5

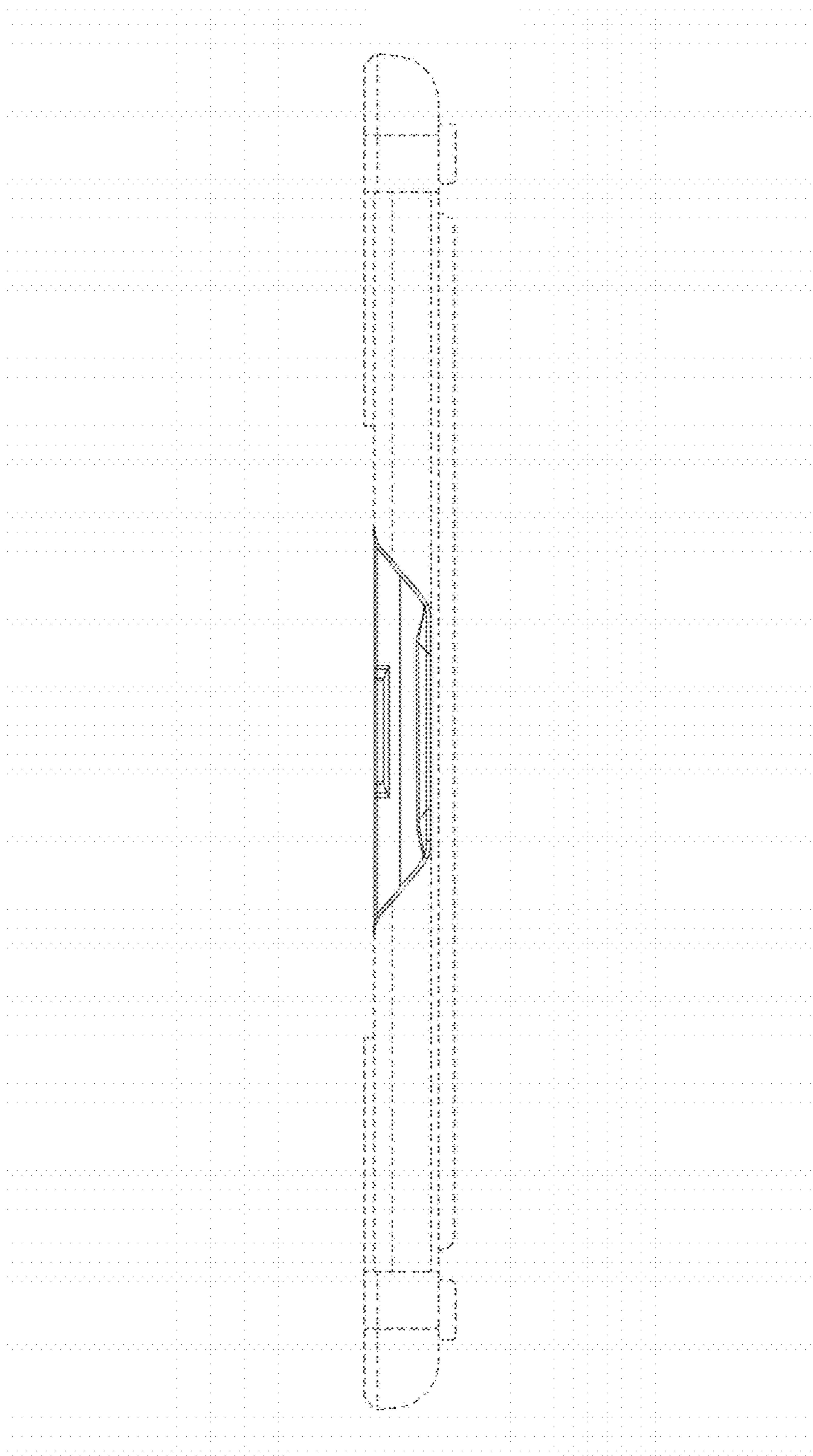

FIG. 6

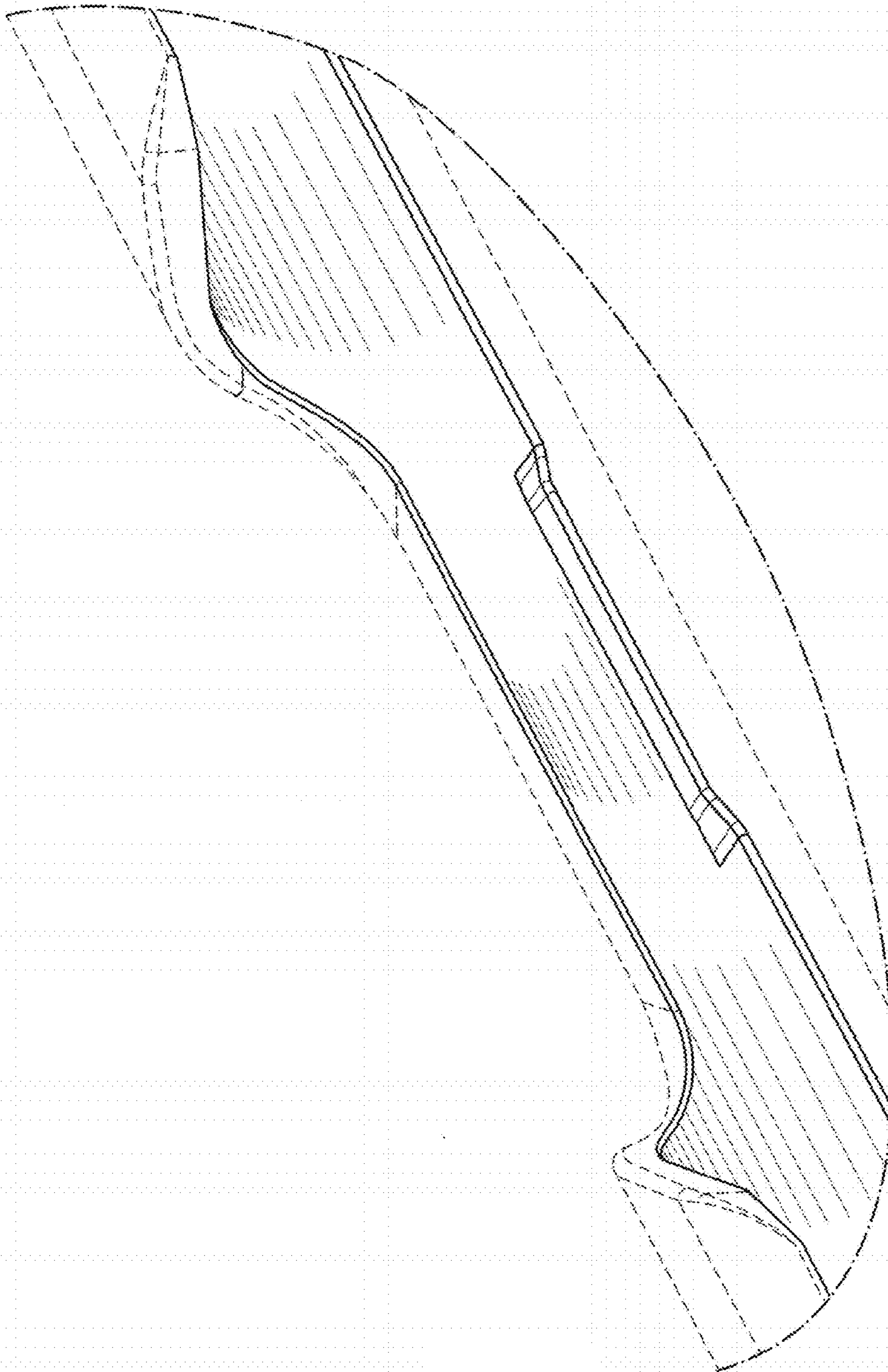

FIG. 7

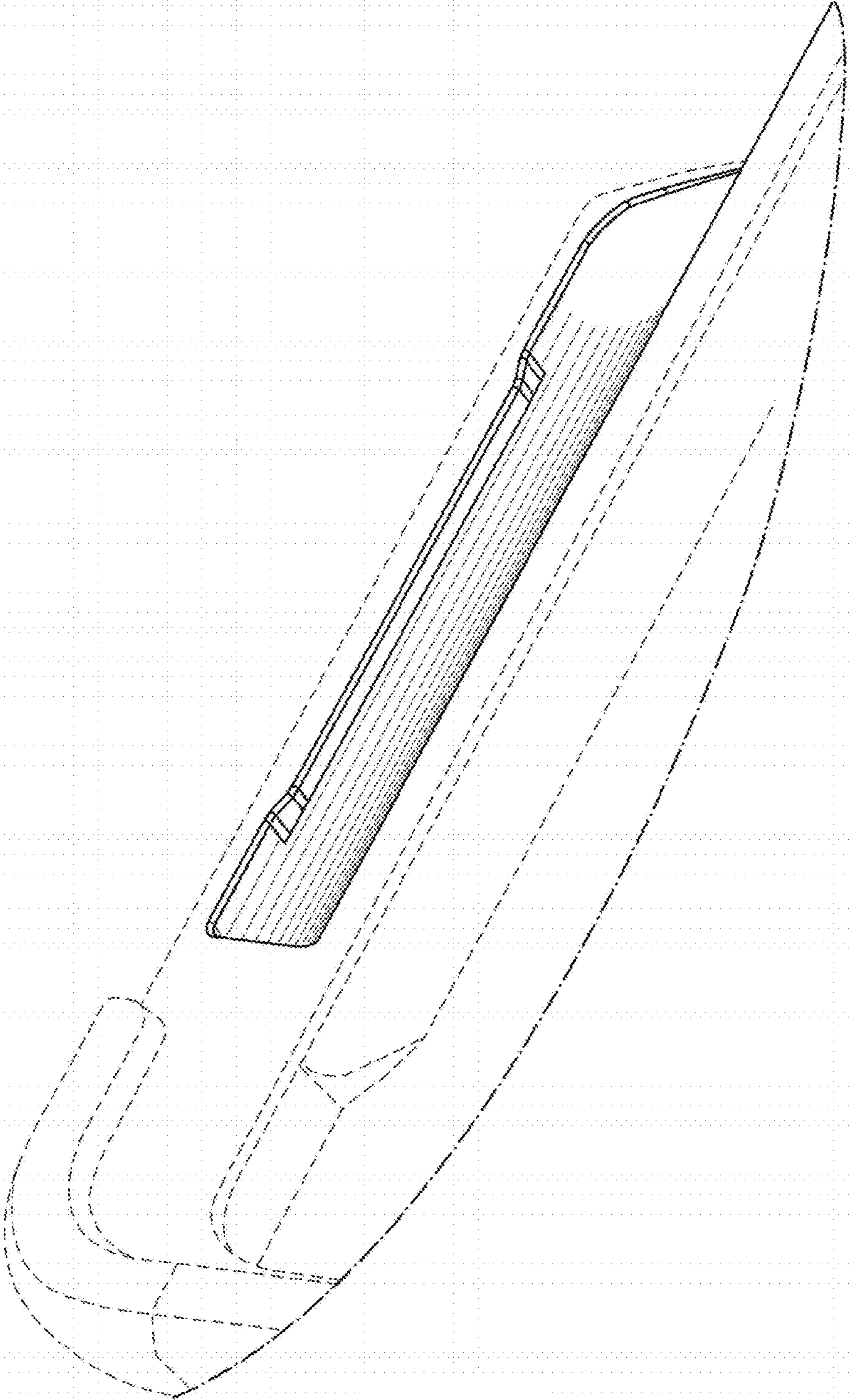

FIG. 8