



US00D812559S

(12) **United States Design Patent** (10) **Patent No.:** **US D812,559 S**  
**Xu** (45) **Date of Patent:** **\*\* Mar. 13, 2018**

(54) **CHARGER**

(71) Applicant: **GUANG DONG BESTEK**  
**E-commerce Co., Ltd, Shenzhen (CN)**

(72) Inventor: **Xinhua Xu, Shenzhen (CN)**

(73) Assignee: **GUANG DONG BESTEK**  
**E-commerce Co., Ltd, Shenzhen (CN)**

(\*\*) Term: **15 Years**

(21) Appl. No.: **29/576,190**

(22) Filed: **Aug. 31, 2016**

(51) **LOC (11) Cl.** ..... **13-02**

(52) **U.S. Cl.**  
USPC ..... **D13/107**

(58) **Field of Classification Search**  
USPC ..... D13/102–110, 118–119, 184, 199;  
D14/356, 432  
CPC ..... Y02E 60/10; Y02E 60/12; Y02E 60/122;  
Y02E 60/124; Y02E 60/50; H01M 2/02;  
H01M 2/022; H01M 2/0202; H01M  
2/0207; H01M 2/0212; H01M 2/1061;  
H01M 2/1022; H01M 2/1055; H01M  
2/1066; H01M 2/105; H01M 2/20; H01M  
2/202; H01M 2/204; H01M 2/206; H01M  
10/44; H01M 10/46; H01M 10/465;  
H01M 10/482; H01M 2200/30; H01M  
2250/30; H01M 2250/40; H02J 7/00;  
H02J 7/0003; H02J 7/0011; H02J 7/0013;  
H02J 7/0054; H02J 7/0055; H02J 7/0057;  
H02J 2007/0062

See application file for complete search history.

(56) **References Cited**

U.S. PATENT DOCUMENTS

D391,944 S \* 3/1998 Han ..... D14/356  
D482,653 S \* 11/2003 Cho ..... D13/110

D542,786 S \* 5/2007 Karlsson ..... D14/302  
D609,636 S \* 2/2010 Jensen ..... D13/108  
D659,093 S \* 5/2012 Schmid ..... D13/108  
D660,834 S \* 5/2012 Akana ..... D14/314  
D706,212 S \* 6/2014 Zwierstra ..... D13/107  
D714,787 S \* 10/2014 Matsuoka ..... D14/426  
D720,289 S \* 12/2014 Chiang ..... D13/108  
D772,813 S \* 11/2016 Wahl ..... D13/108  
D777,100 S \* 1/2017 Price ..... D13/103  
D780,136 S \* 2/2017 Chudoba ..... D13/184  
2016/0276856 A1 \* 9/2016 Miller ..... H02J 7/0042

**OTHER PUBLICATIONS**

Bestek Snail Charger, Bestek Global Ltd., amazon.co.uk, date first available Jun. 7, 2016, retrieved on May 3, 2017, retrieved from the Internet: URL<<https://www.amazon.co.uk/BESTEK-SNAIL-CHARGER-FOR-EU/dp/B00LTP7EOA>>.\*

\* cited by examiner

*Primary Examiner* — Rosemary K Tarcza  
*Assistant Examiner* — Alison M Ofstun  
(74) *Attorney, Agent, or Firm* — Wayne & King LLC

(57) **CLAIM**

The ornamental design for charger, as shown and described.

**DESCRIPTION**

FIG. 1 is a perspective view of a charger, showing my new design;  
FIG. 2 is a front view thereof;  
FIG. 3 is a back view thereof;  
FIG. 4 is a left side view thereof;  
FIG. 5 is a right side view thereof;  
FIG. 6 is a top plan view thereof; and,  
FIG. 7 is a bottom plan view thereof.  
The broken lines shown in the figures are included for the purpose of illustrating portions of the charger which form no part of the claimed design.

**1 Claim, 7 Drawing Sheets**

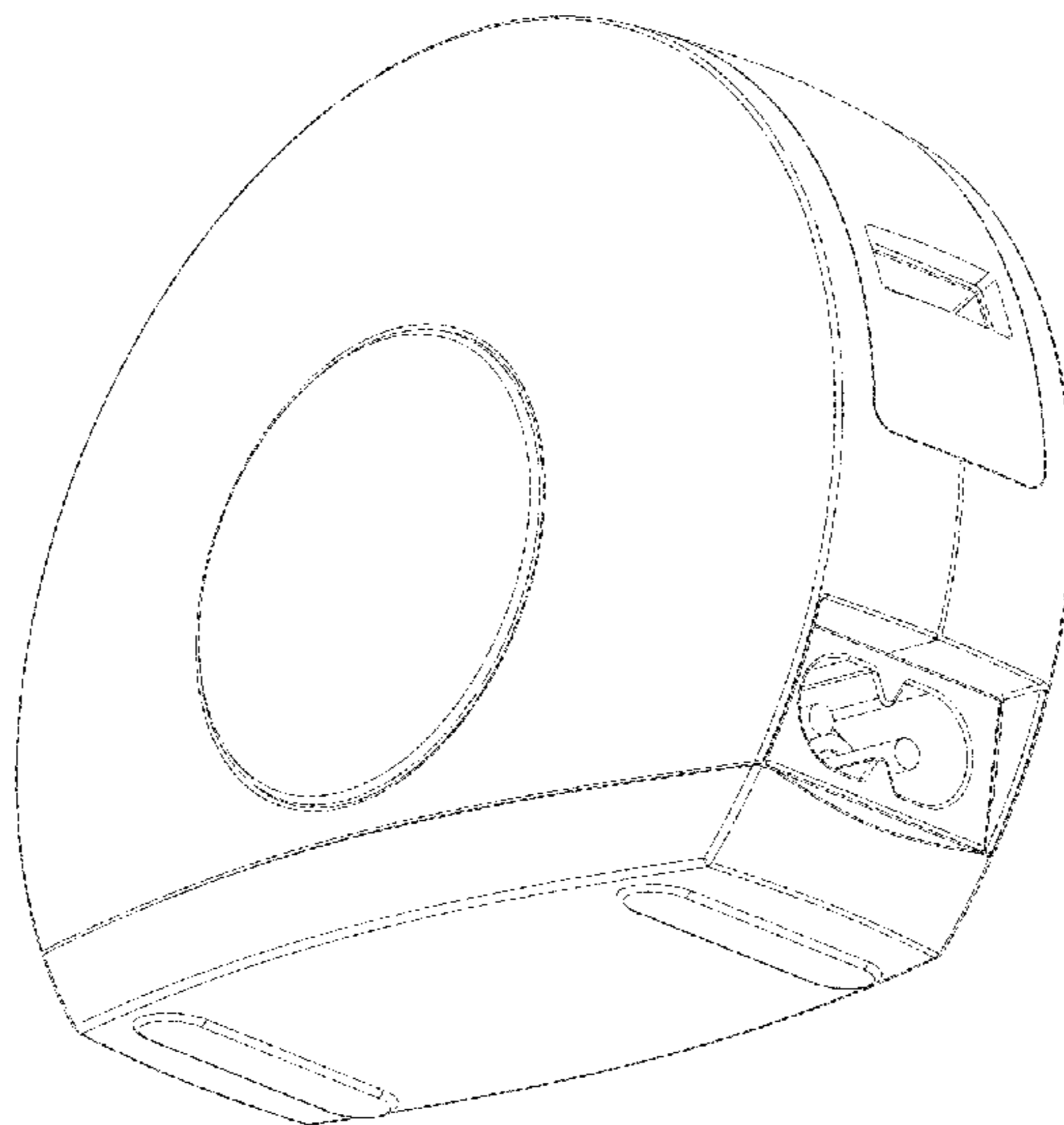

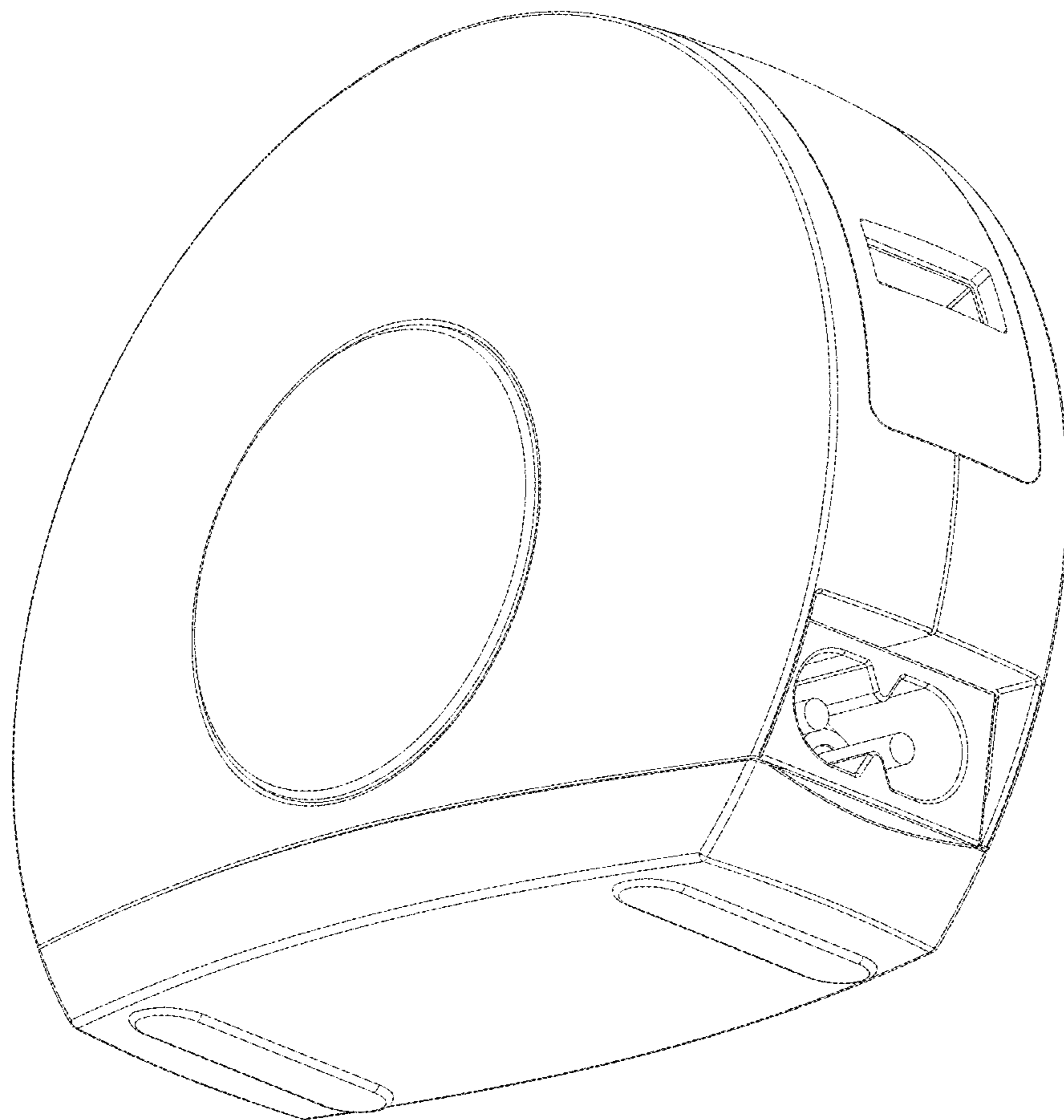

FIG. 1

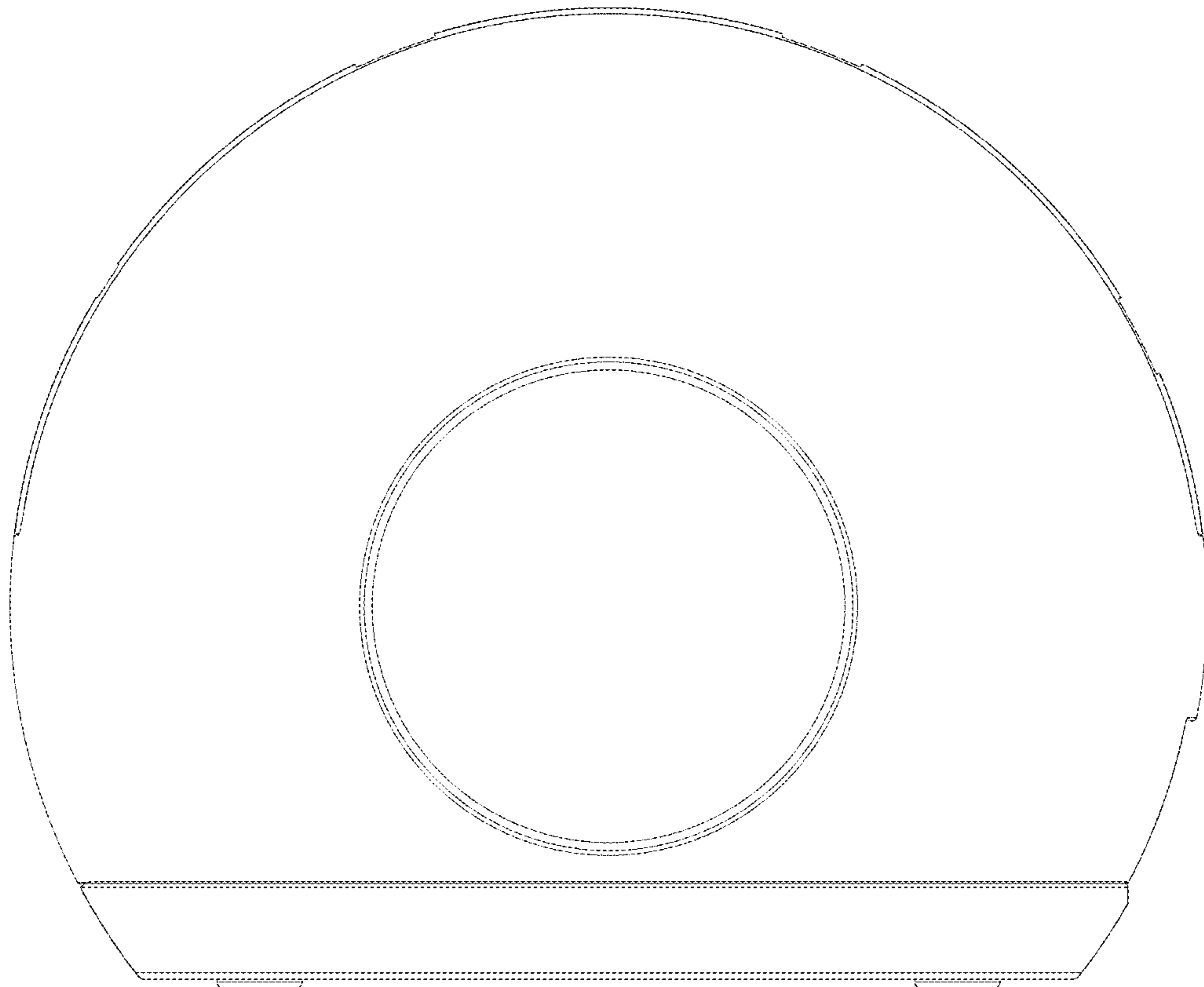

FIG.2

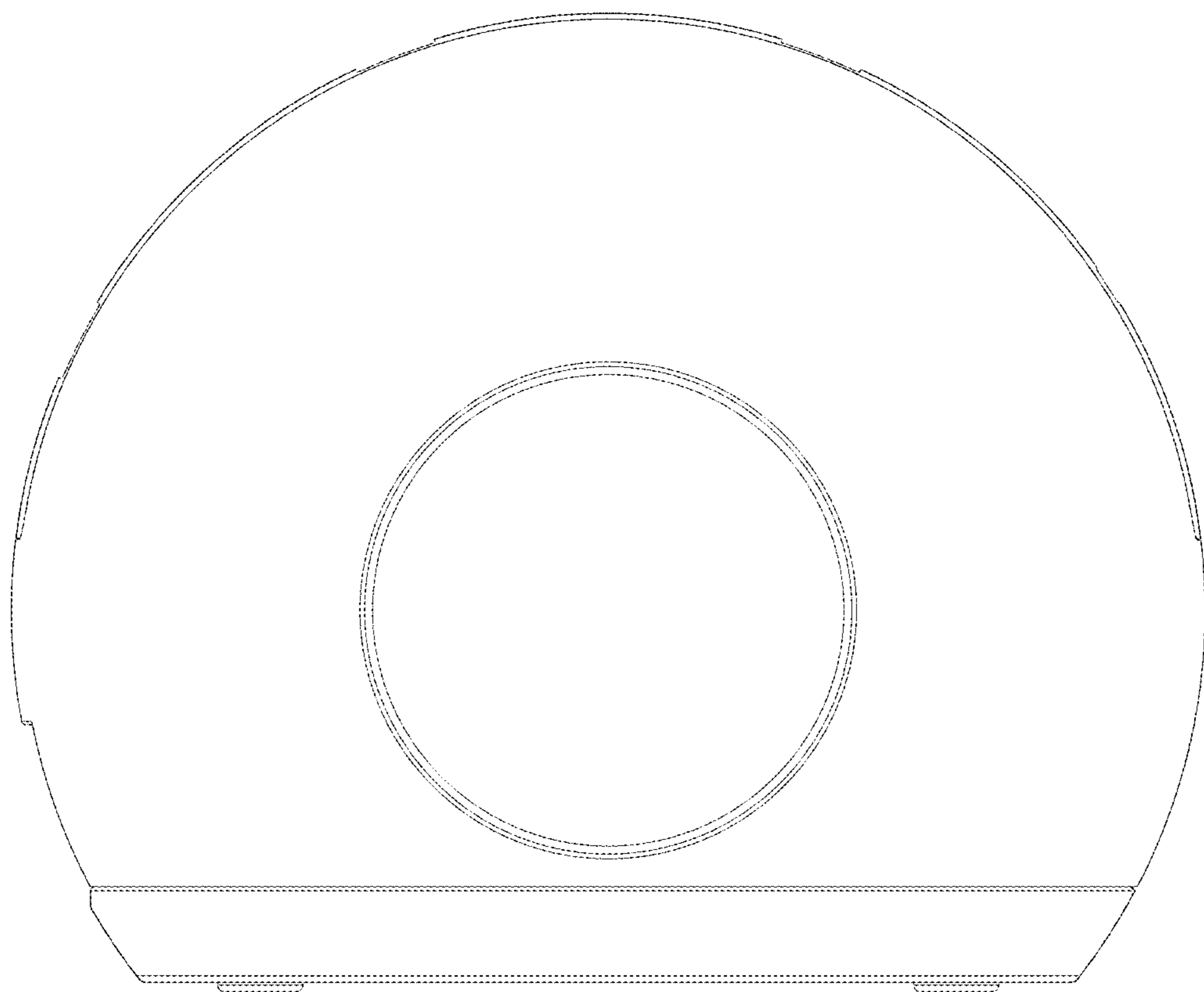

FIG. 3

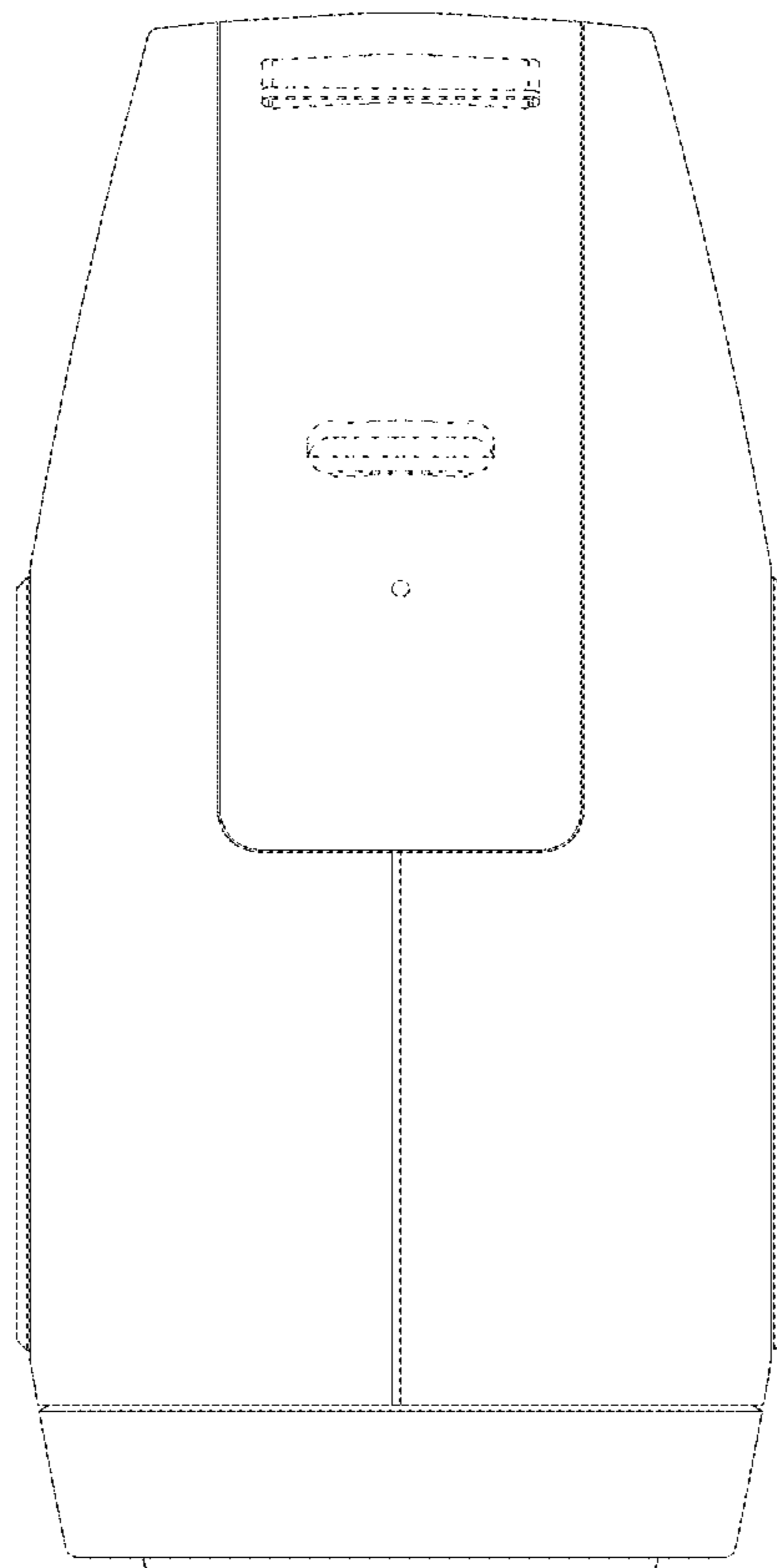

FIG. 4

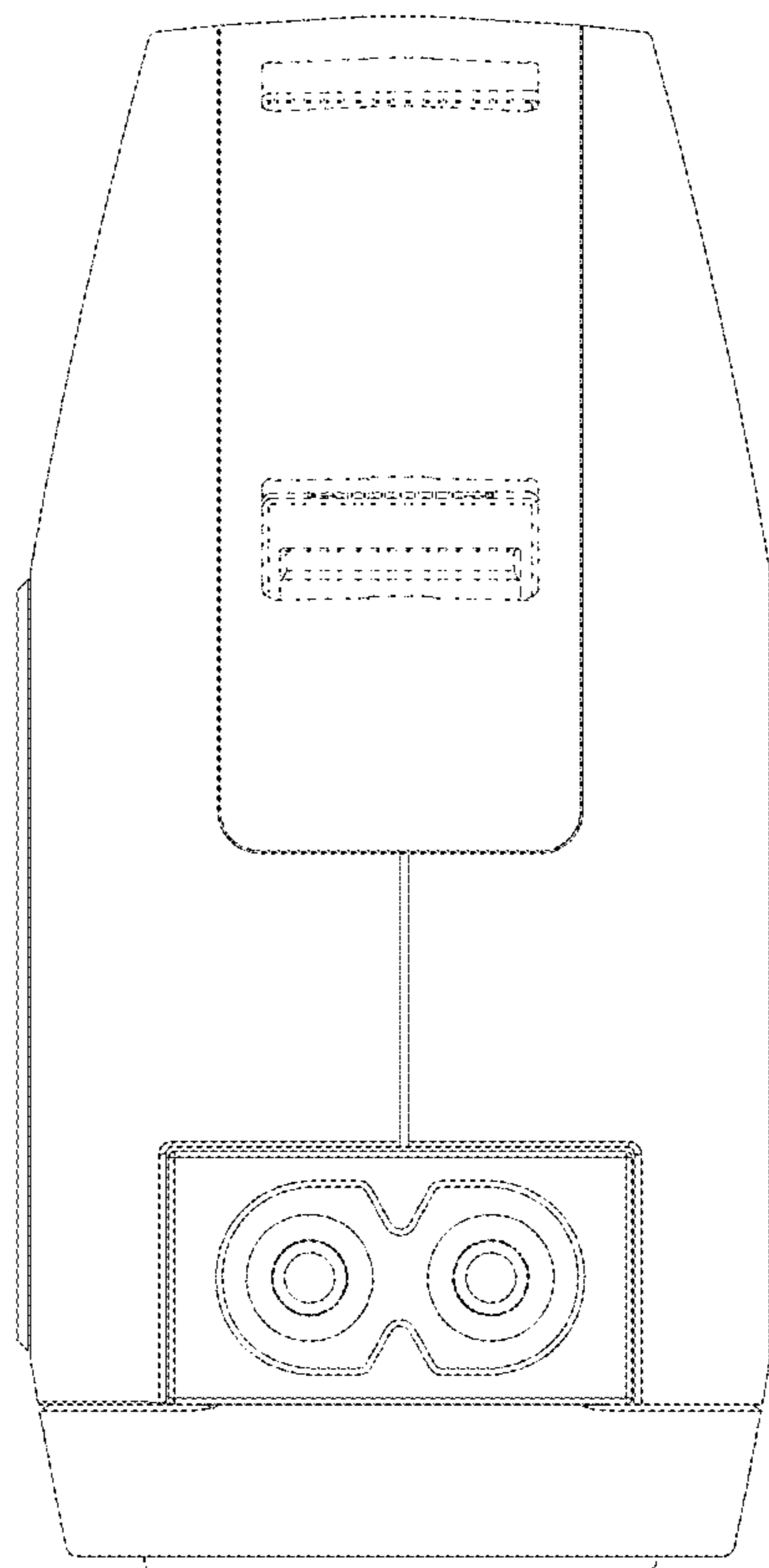

FIG. 5

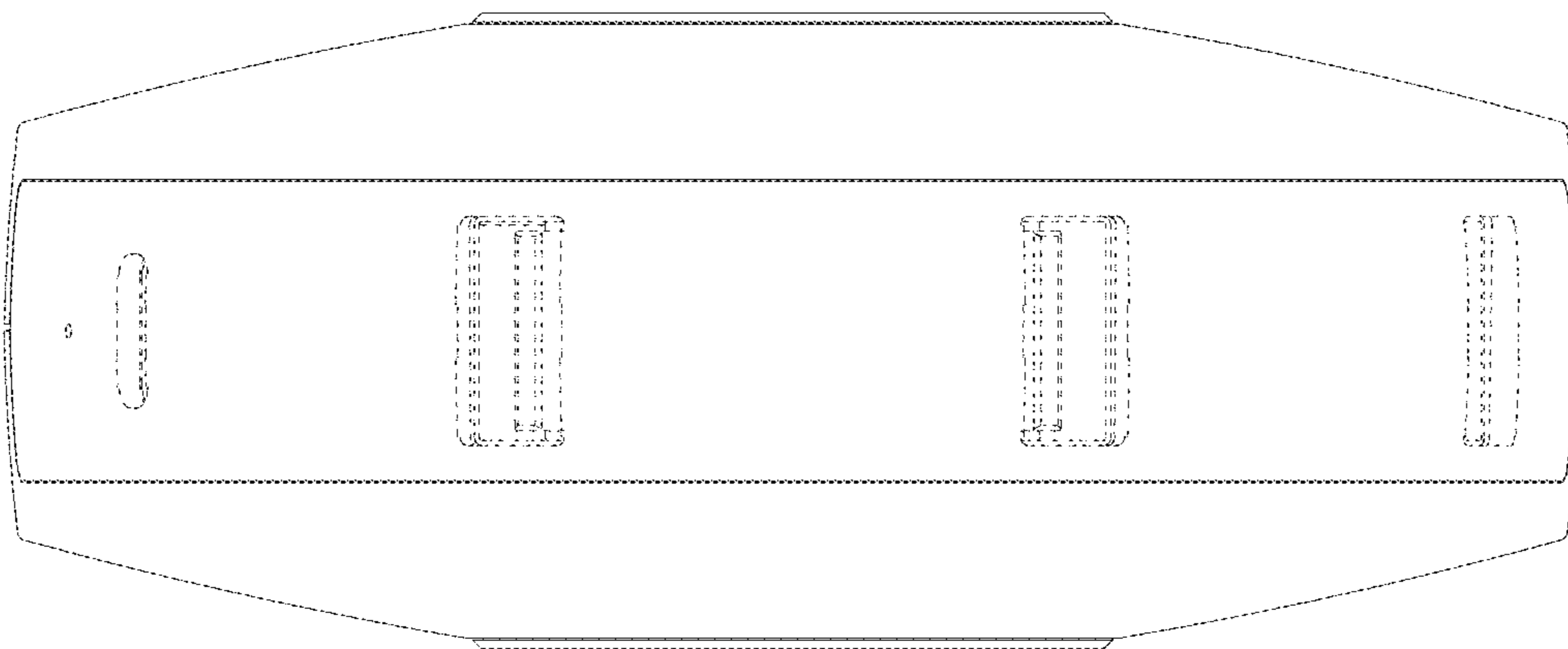

FIG. 6

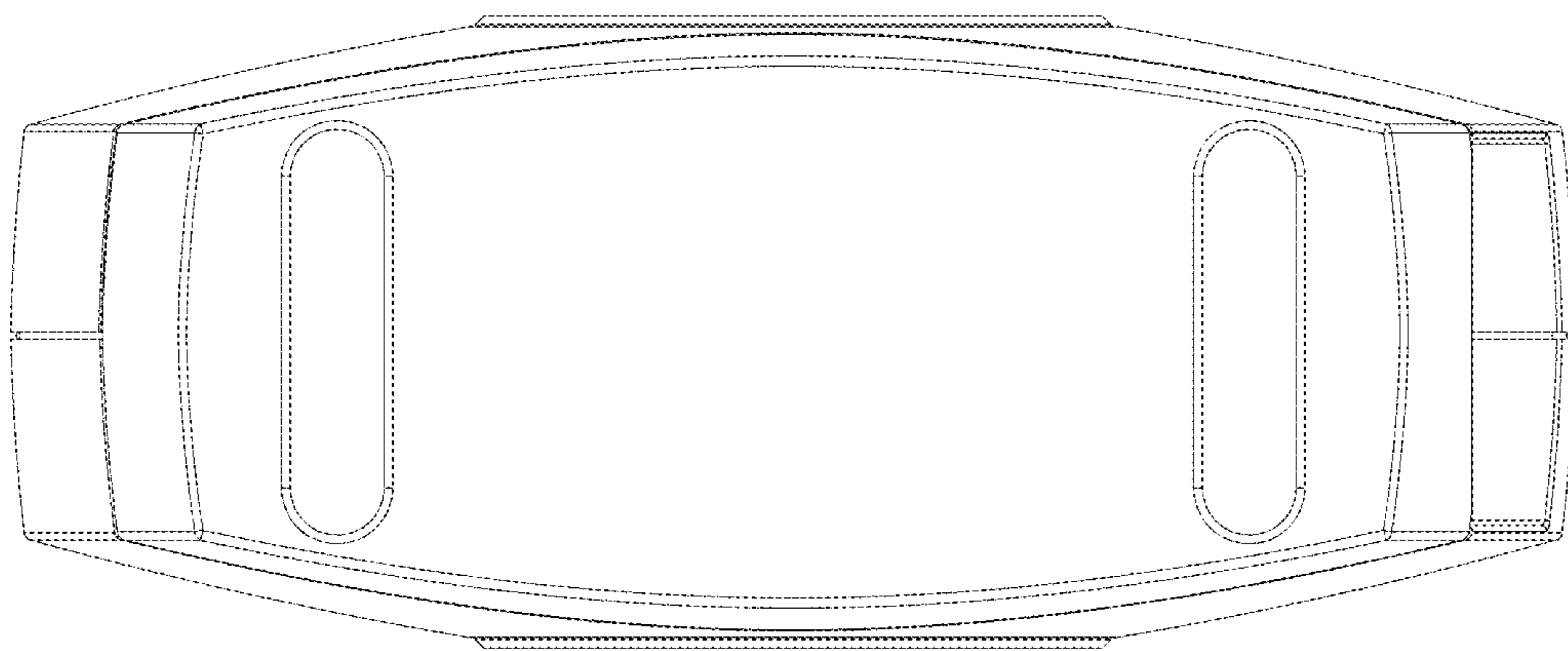

FIG. 7