



US00D812520S

(12) **United States Design Patent**  
**Di Girolami et al.**

(10) **Patent No.:** **US D812,520 S**  
(45) **Date of Patent:** **\*\* Mar. 13, 2018**

(54) **SLIDER FOR SLIDE FASTENER**  
(71) Applicant: **YKK Corporation**, Tokyo (JP)  
(72) Inventors: **Massimiliano Di Girolami**, Cheshire (GB); **Yoshikazu Hamada**, Toyama (JP)  
(73) Assignee: **YKK Corporation** (JP)

D627,259 S \* 11/2010 Miyazaki ..... D11/221  
D631,790 S \* 2/2011 Keyaki ..... D11/221  
D643,336 S \* 8/2011 Di Girolami ..... D11/221  
D643,779 S \* 8/2011 Di Girolami ..... D11/221  
D653,170 S \* 1/2012 Hamada ..... D11/221  
D653,171 S \* 1/2012 Hamada ..... D11/221  
D653,586 S \* 2/2012 Hamada ..... D11/221

(Continued)

(\*\*) Term: **15 Years**  
(21) Appl. No.: **29/587,954**  
(22) Filed: **Dec. 16, 2016**

**OTHER PUBLICATIONS**

5# square Metal Zipper Slider zinc alloy slider for handbags, GlobalSources.com, [online], [site visited Sep. 14, 2017]. <URL: <http://www.globalsources.com/gsol1/Zipper-slider/p/sm/1153296254.htm#1153296254>>.\*

(Continued)

(30) **Foreign Application Priority Data**

Jun. 17, 2016 (EM) ..... 003227644-0007

(51) **LOC (11) Cl.** ..... **15-07**  
(52) **U.S. Cl.**  
USPC ..... **D11/221**

(58) **Field of Classification Search**  
USPC ..... D11/200-201, 221; 24/381-383, 24/385-387, 414-431, 4, 412; D2/641; 294/3.6  
CPC ..... A44B 19/00; A44B 19/02; A44B 19/04; A44B 19/10; A44B 19/24; A44B 19/26; A44B 19/30; A44B 19/06  
See application file for complete search history.

*Primary Examiner* — T. Chase Nelson

*Assistant Examiner* — Jonathan J. Han

(74) *Attorney, Agent, or Firm* — Kilpatrick Townsend & Stockton LLP

(57) **CLAIM**

The ornamental design for a slider for slide fastener, as shown and described.

**DESCRIPTION**

FIG. 1 is a perspective view of the front, bottom and right side of a slider for slide fastener, showing our new design; FIG. 2 is a front view thereof; FIG. 3 is a rear view thereof; FIG. 4 is a right side view thereof, the left side view being a mirror image thereof; FIG. 5 is a top plan view thereof; FIG. 6 is a bottom view thereof; and, FIG. 7 is a cross-sectional view taken along a line 7-7 in FIG. 4.

The broken lines shown are included for the purpose of illustrating the unclaimed portions of a slider for slide fastener and form no part of the claimed design.

**1 Claim, 7 Drawing Sheets**

(56) **References Cited**

**U.S. PATENT DOCUMENTS**

2,599,536 A \* 6/1952 Backer ..... A44B 19/306 24/421  
4,525,903 A \* 7/1985 Ishii ..... A44B 19/26 24/429  
D380,984 S \* 7/1997 Mizuno ..... D11/221  
D556,088 S \* 11/2007 Cossutti ..... D11/221  
D607,775 S \* 1/2010 Miyazaki ..... D11/221  
D612,292 S \* 3/2010 Miyazaki ..... D11/221  
D627,258 S \* 11/2010 Miyazaki ..... D11/221

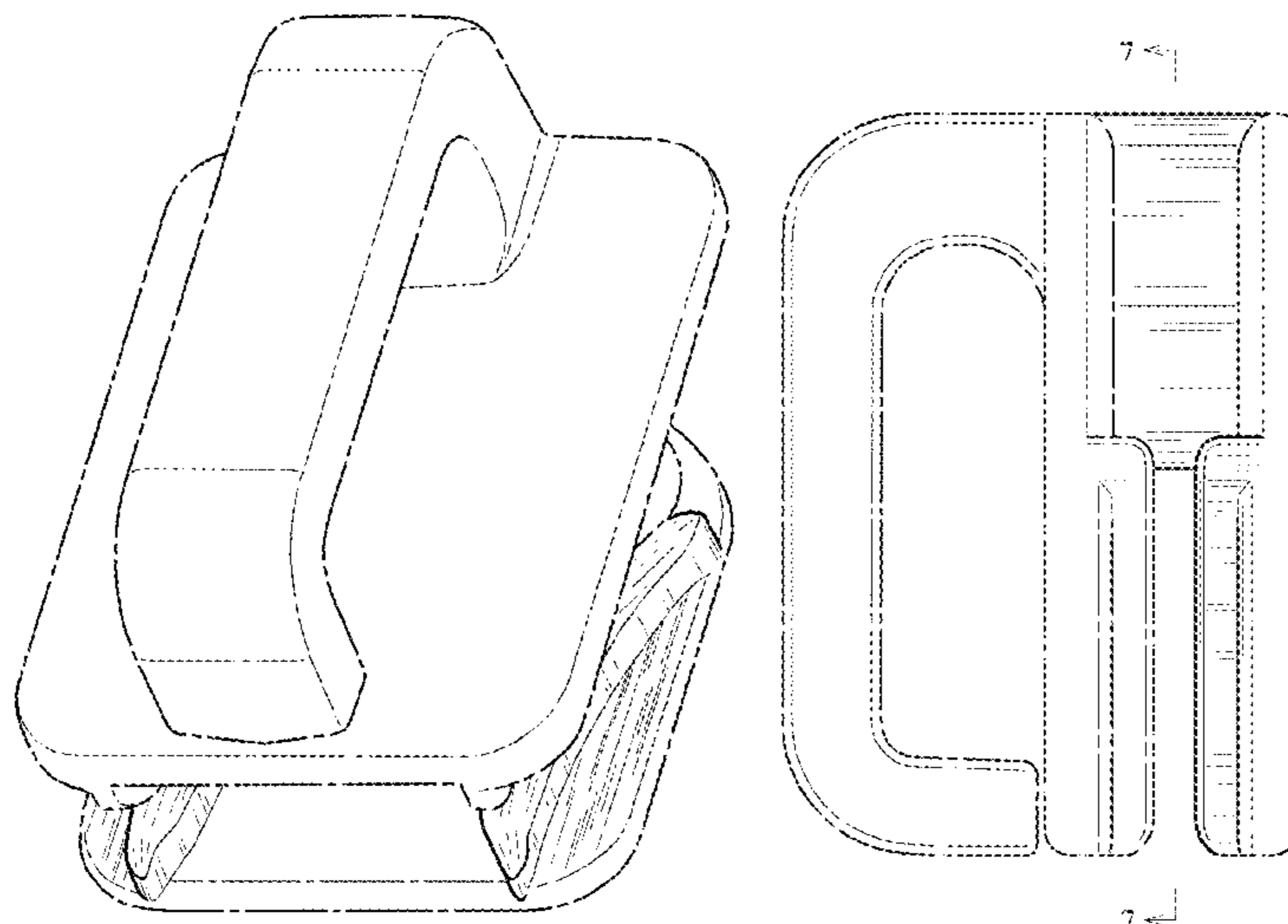

(56)

References Cited

U.S. PATENT DOCUMENTS

D721,617	S *	1/2015	Ozawa	.....	D11/221
D741,750	S *	10/2015	Ng	.....	D11/221
D780,622	S *	3/2017	Lin	.....	D11/221
D794,504	S *	8/2017	Takazawa	.....	D11/221
D795,740	S *	8/2017	Takazawa	.....	D11/221
D796,992	S *	9/2017	Takazawa	.....	D11/221
D796,993	S *	9/2017	Takazawa	.....	D11/221
D796,994	S *	9/2017	Takazawa	.....	D11/221
2004/0163219	A1 *	8/2004	Wu	.....	A44B 19/262 24/429
2006/0218758	A1 *	10/2006	Chang	.....	A44B 19/262 24/431
2009/0313793	A1 *	12/2009	Lin	.....	A44B 19/26 24/429
2013/0318751	A1 *	12/2013	Lin	.....	A44B 19/42 24/429
2013/0340213	A1 *	12/2013	Chung	.....	A44B 19/382 24/382
2015/0189954	A1 *	7/2015	Yoneoka	.....	A44B 19/26 24/428
2016/0157566	A1 *	6/2016	Lin	.....	A44B 19/308 24/429

OTHER PUBLICATIONS

Eddie Borgo Yellow Gold Zipper Slide Stud Earrings, NeimanMarcus.com, [online], [site visited Sep. 14, 2017]. <URL: <http://www.neimanmarcus.com/Eddie-Borgo-Yellow-Gold-Zipper-Slide-Stud-Earrings/prod168370007/p.prod>>.\*

Universal #8 Aluminum Slider, ZipperStop.com, [online], [site visited Sep. 14, 2017]. <URL: <https://www.zipperstop.com/product/universal-8-aluminum-slider/>>.\*

Zipper slider stud earrings, Etsy.com, [online], [site visited Sep. 14, 2017]. <URL: [https://www.etsy.com/listing/481484218/zipper-slider-stud-earrings-funky?ga\\_order=most\\_relevant&ga\\_search\\_type=all&ga\\_view\\_type=gallery&ga\\_search\\_query=zipper sliders&ref=sc\\_gallery\\_1&plkey=4c998a528ee0b7b488ca09902a69d4518cab82a4:481484218](https://www.etsy.com/listing/481484218/zipper-slider-stud-earrings-funky?ga_order=most_relevant&ga_search_type=all&ga_view_type=gallery&ga_search_query=zipper sliders&ref=sc_gallery_1&plkey=4c998a528ee0b7b488ca09902a69d4518cab82a4:481484218)>.\*

YKK #5 Vision Short Tab Zipper Slider-Black-10 Pack, Etsy.com, [online], [site visited Sep. 14, 2017]. <URL: [https://www.etsy.com/listing/469737748/ykk-5-vision-short-tab-zipper-slider?ga\\_order=most\\_relevant&ga\\_search\\_type=all&ga\\_view\\_type=gallery&ga\\_search\\_query=zipper sliders&ref=sr\\_gallery\\_27](https://www.etsy.com/listing/469737748/ykk-5-vision-short-tab-zipper-slider?ga_order=most_relevant&ga_search_type=all&ga_view_type=gallery&ga_search_query=zipper sliders&ref=sr_gallery_27)>.\*

Speare Tools Hand Sander w/Med Grit Sponge, Wind-Lock.com, [online], [site visited Sep. 14, 2017]. <URL: <https://www.wind-lock.com/hand-sanders/speare-tools-hand-sander-w-med-grit-sponge-w--spthbsdk200m?returnurl=%2fhand-sanders%2f>>.\*

\* cited by examiner

Fig. 1

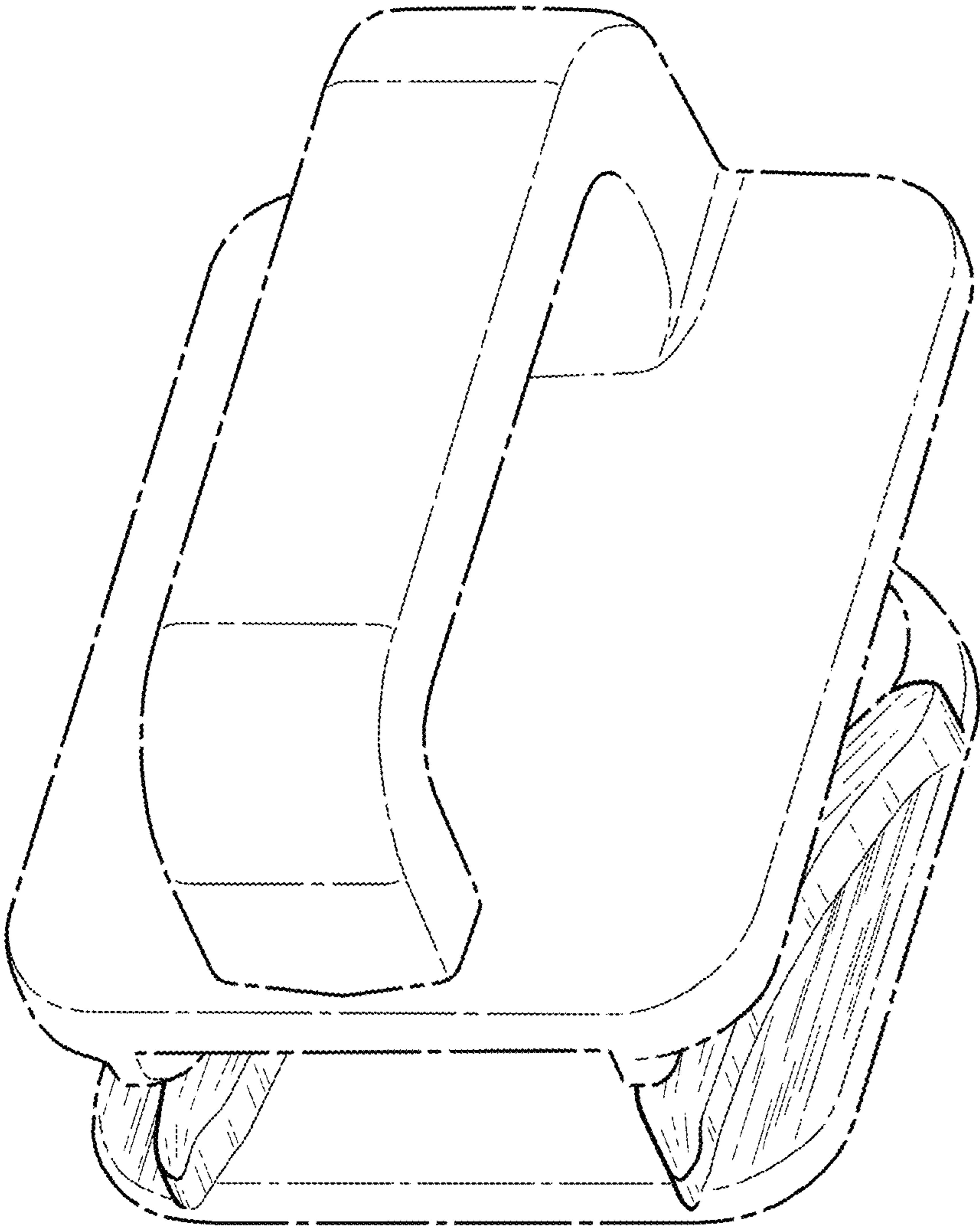

Fig. 2

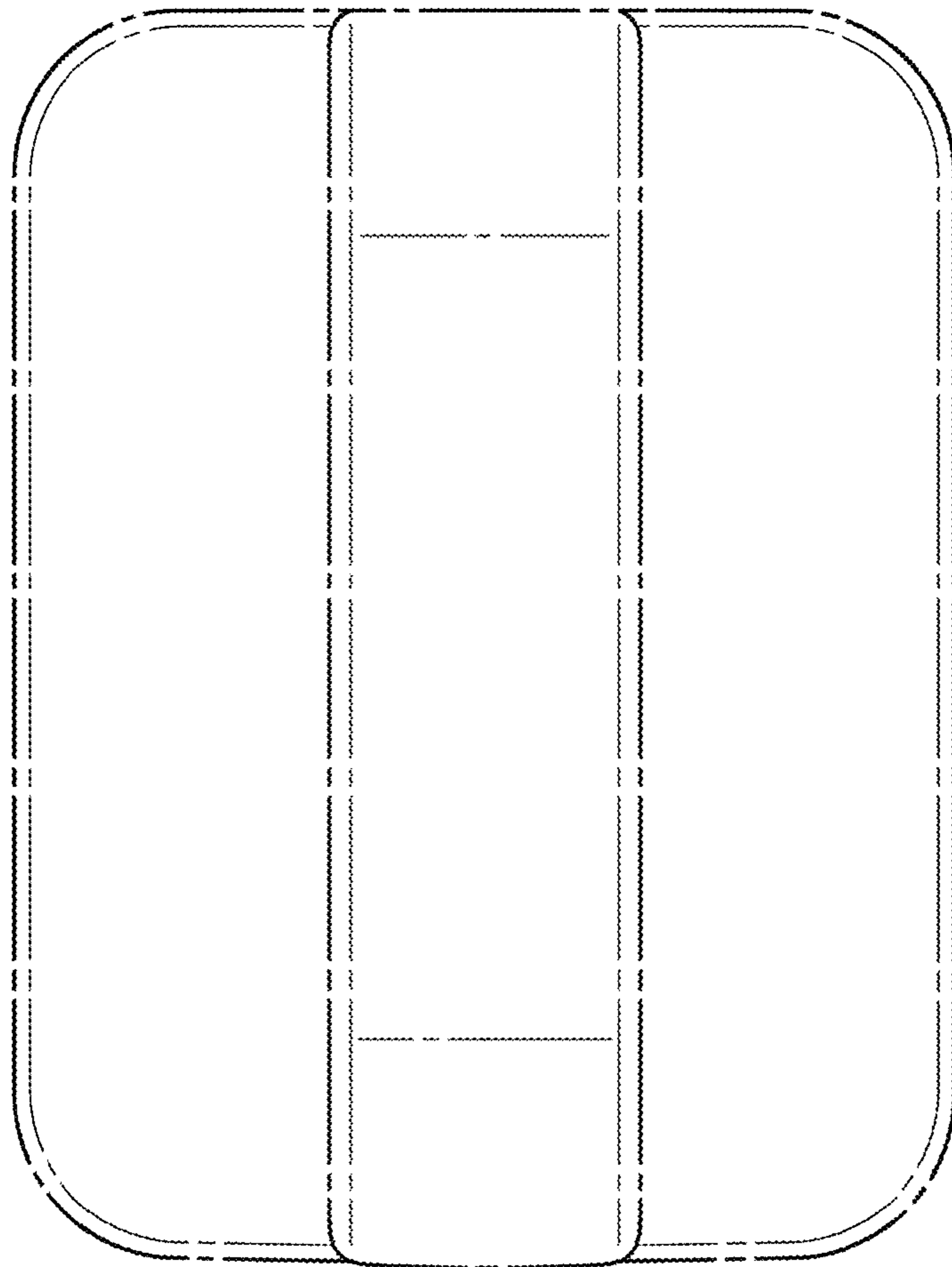

Fig. 3

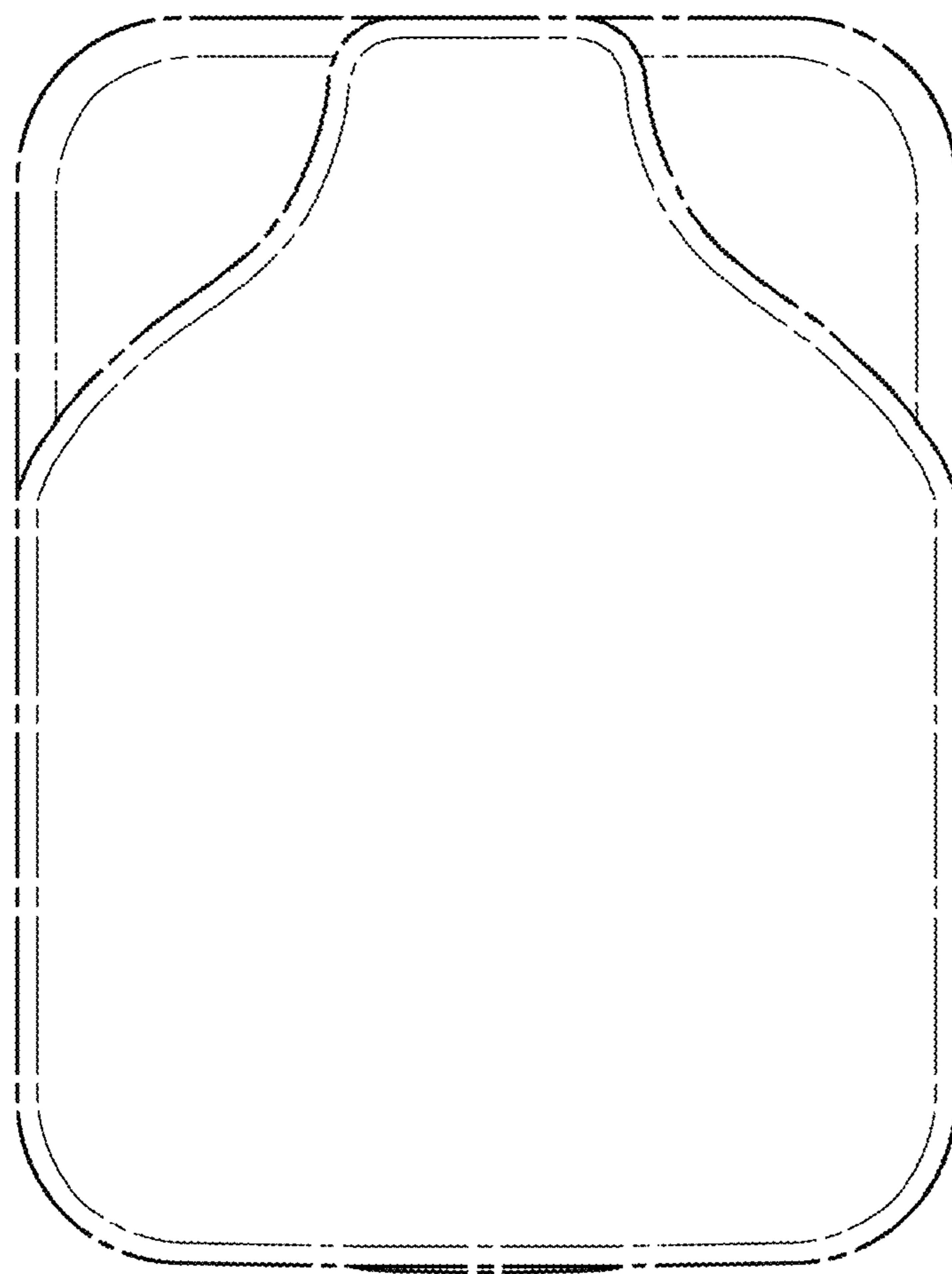

Fig. 4

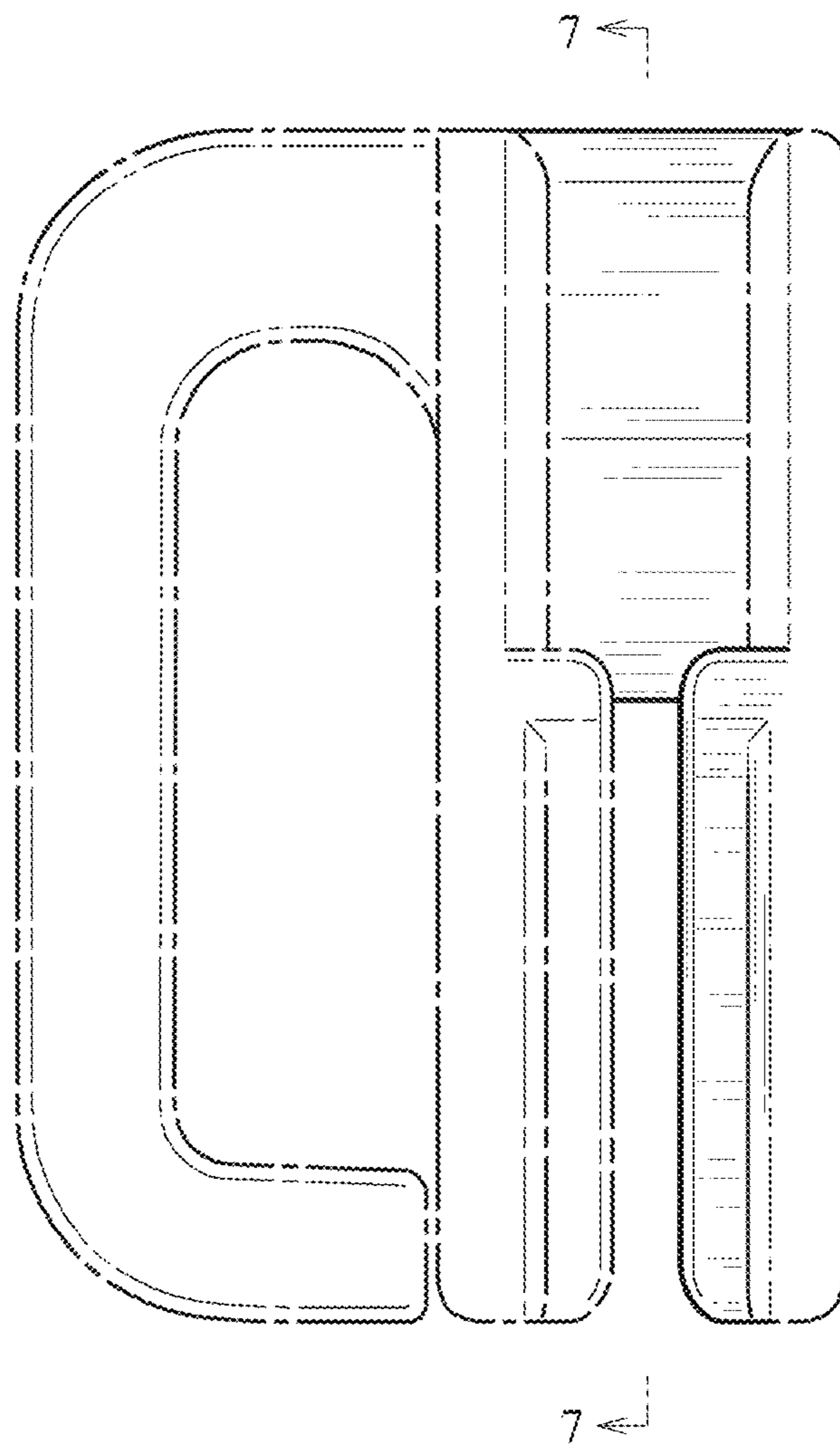

Fig. 5

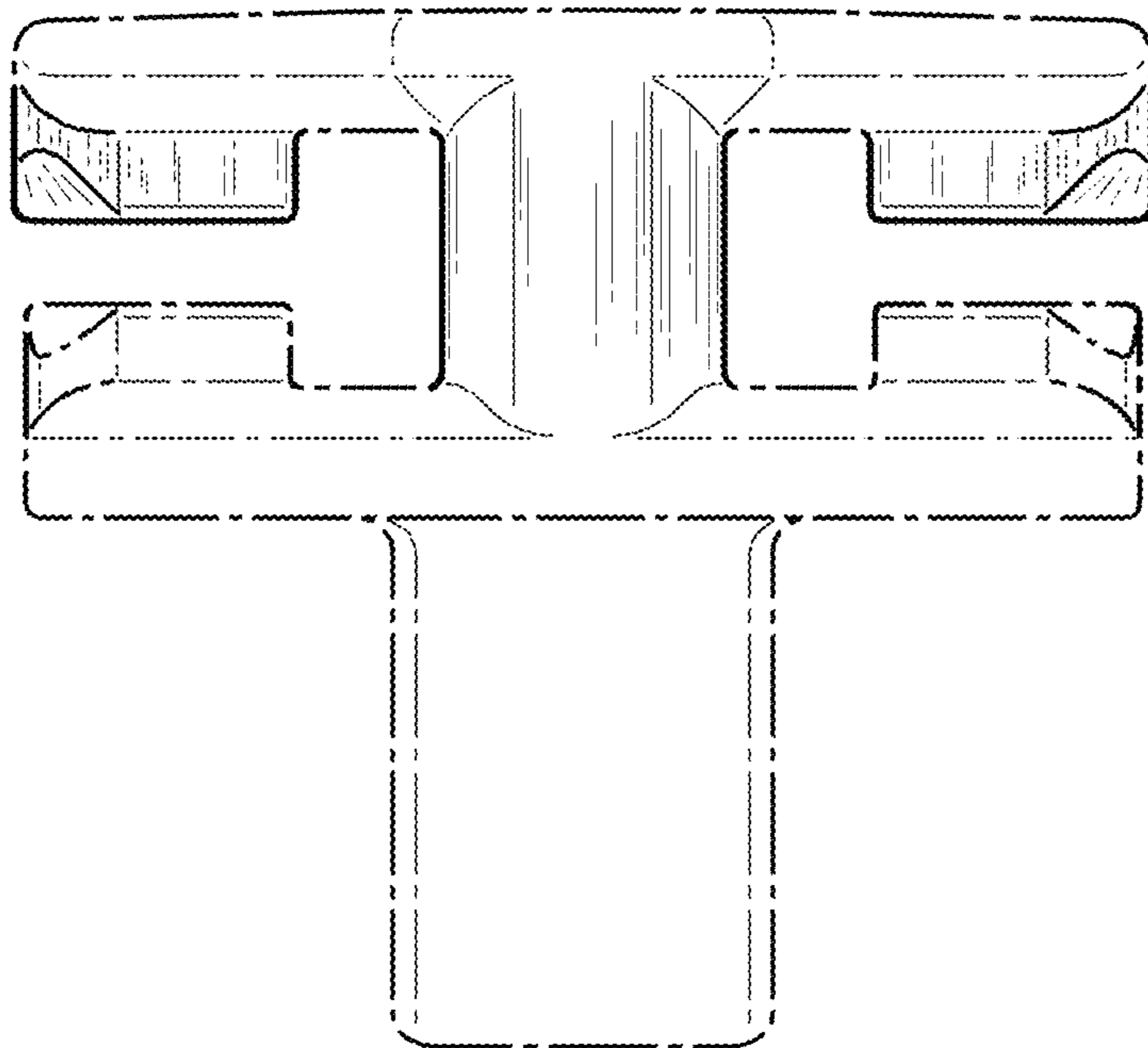

Fig. 6

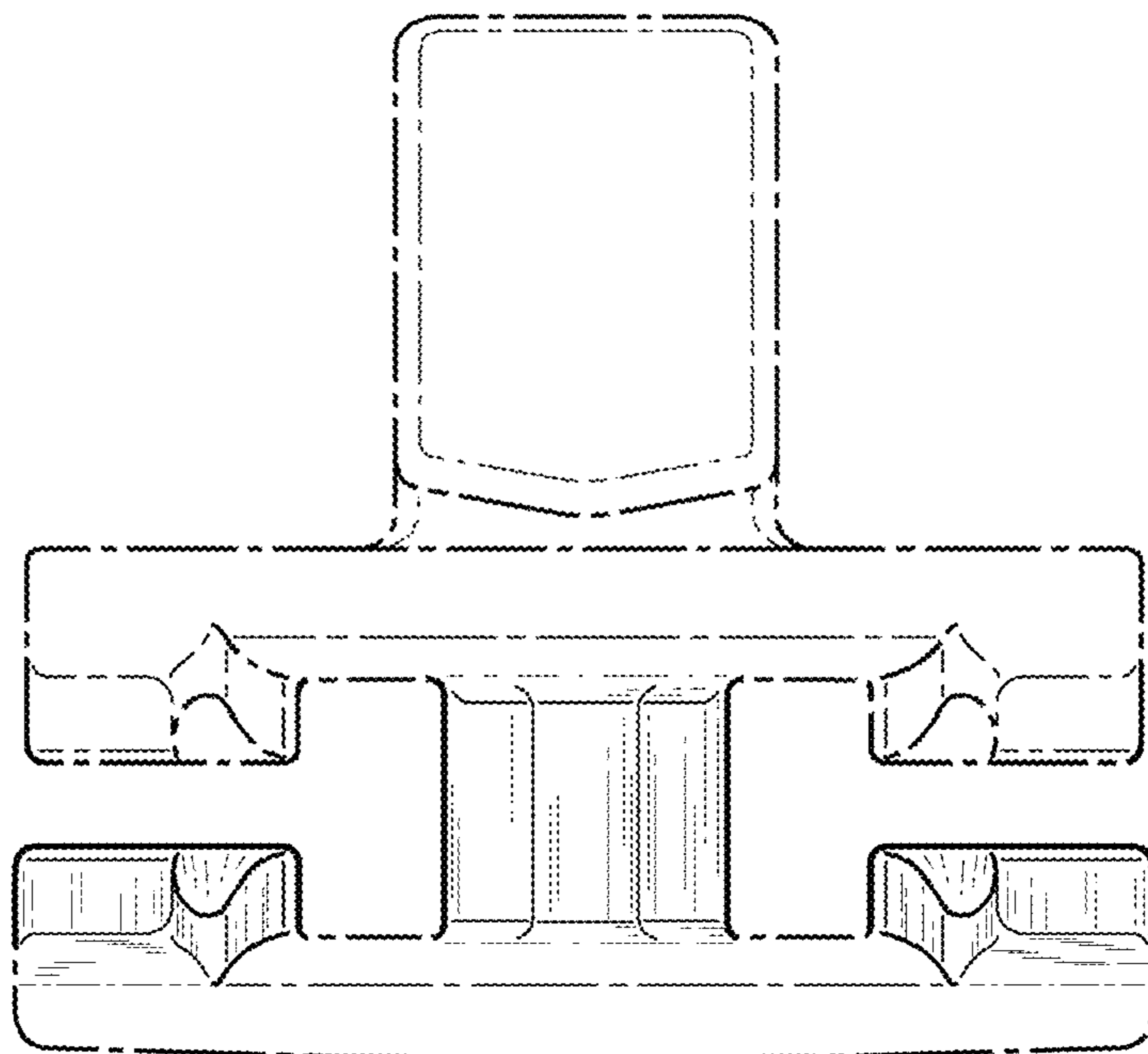



Fig. 7

